

Project Narrative/Notes/Revisions

- 1) 11/19/15 CK - COMPLETED DESIGN FOR CLIENT & COUNTY REVIEW.
- 2) 11/23/15 TH - QUALITY CONTROL CHECK & INTERNAL REVIEW.
- 3) 12/22/15 WS - PUMP DESIGN & IRRIGATION SYSTEM UPDATES.
- 4) 03/24/16 CK - UPDATED PLANS PER COUNTY COMMENTS.
- 5) 07/12/16 CK - REMOVED STUB ROAD PER CLIENT REQUEST.
- 6) 09/27/16 WS - UPDATED PLANS PER COUNTY COMMENTS.

Henry Flats Cluster Subdivision Improvement Plans

WEST WEBER CITY, WEBER COUNTY, UTAH
NOVEMBER, 2015

Reeve & Associates, Inc. - Solutions You Can Build On

Reeve & Associates, Inc. - Solutions You Can Build On

Reeve & Associates, Inc.
5160 SOUTH 1500 WEST, RIVERDALE, UTAH 84405
TEL: (801) 621-2100 FAX: (801) 621-2666 www.reeve-assoc.com
LAND PLANNERS • CIVIL ENGINEERS • LAND SURVEYORS
TRAFFIC ENGINEERS • STRUCTURAL ENGINEERS • LANDSCAPE ARCHITECTS



Vicinity Map
NOT TO SCALE

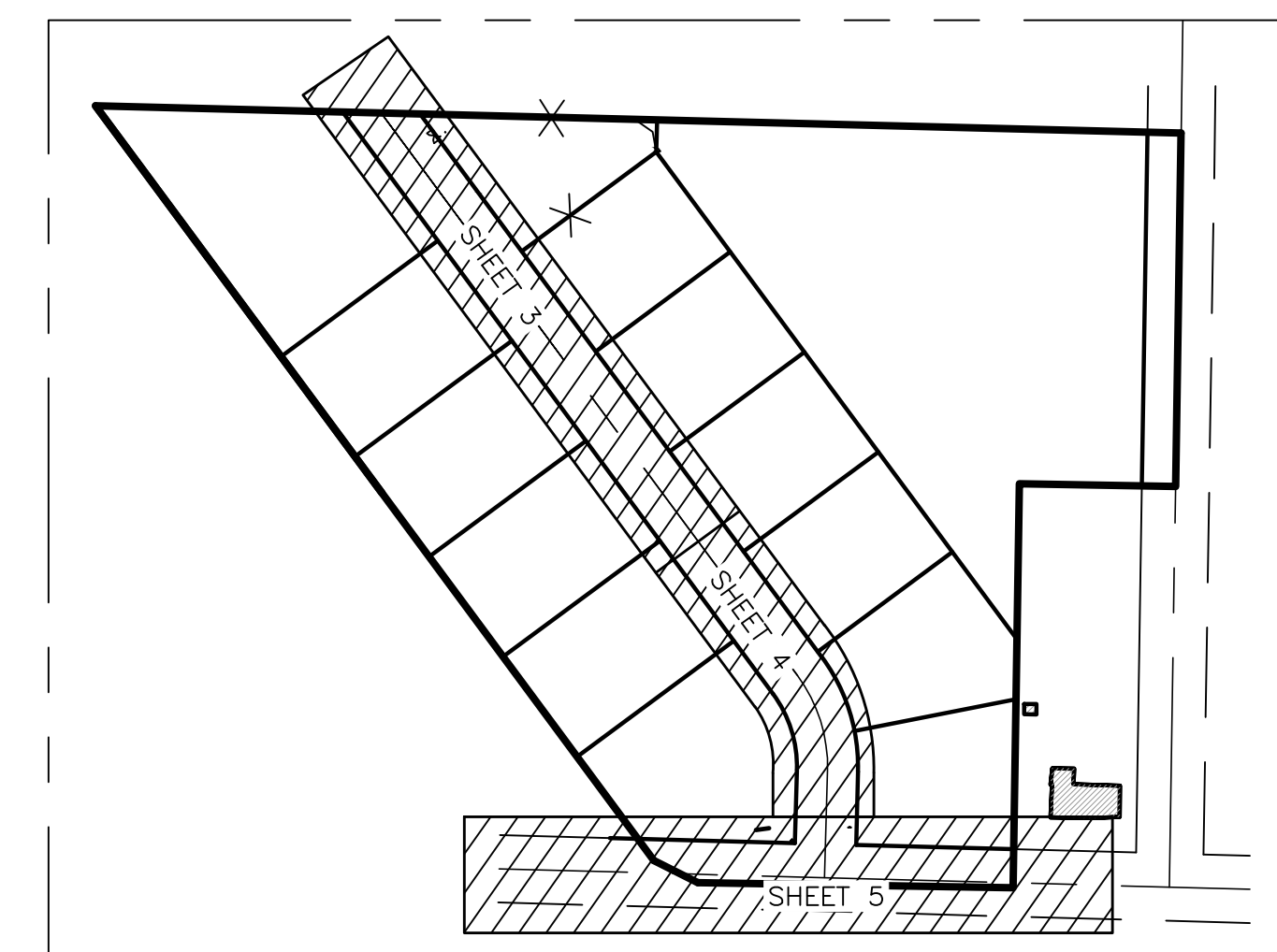

Sheet Index Key Map
NOT TO SCALE

Sheet Index

- Sheet 1 - Cover/Index Sheet
- Sheet 2 - Notes/Legend/Street Cross-Section
- Sheet 3 - 4350 West Street - 4+50.00-10+50.00
- Sheet 4 - 4350 West Street - 10+50.00-14+00.00
- Sheet 5 - 400 South Street - 6+00.00-11+00.00
- Sheet 6 - Master Utility Plan
- Sheet 7 - Master Grading and Drainage Plan
- Sheet 8 - Storm Water Pollution Prevention Plan Exhibit
- Sheet 9 - Storm Water Pollution Prevention Plan Details
- Sheet 10 - Irrigation Pump House Details
- Sheet 10.1 - Pump Details
- Sheet 11 - Detention Basin Grading Plan
- Sheet 12 - APWA Details

Engineer's Notice To Contractors

THE EXISTENCE AND LOCATION OF ANY UNDERGROUND UTILITY PIPES OR STRUCTURES SHOWN ON THESE PLANS WERE OBTAINED FROM AVAILABLE INFORMATION PROVIDED BY OTHERS. THE LOCATIONS SHOWN ARE APPROXIMATE AND SHALL BE CONFIRMED IN THE FIELD BY THE CONTRACTOR, SO THAT ANY NECESSARY ADJUSTMENT CAN BE MADE IN ALIGNMENT AND/OR GRADE OF THE PROPOSED IMPROVEMENT. THE CONTRACTOR IS REQUIRED TO CONTACT THE UTILITY COMPANIES AND TAKE DUE PRECAUTIONARY MEASURE TO PROTECT ANY UTILITY LINES SHOWN, AND ANY OTHER LINES OBTAINED BY THE CONTRACTOR'S RESEARCH, AND OTHERS NOT OF RECORD OR NOT SHOWN ON THESE PLANS.

Developer Contact:

Travis Wallace
PAANC LLC
3872 W. 2550 S.
Taylor City, Weber Co., Utah
PH: (801) 540-9011

Blue Stakes Location Center

Call: Toll Free
1-800-662-4111
Two Working Days Before You Dig

Project Info.

Engineer: J. NATE REEVE
Drafted: C. KINGSLEY
Begin Date: NOVEMBER, 2015
Name: HENRY FLATS CLUSTER SUBDIVISION
Number: 6272-01

Sheet **12**
1 Sheets

Revised: 09-27-16

Henry Flats Cluster Subdivision
WEBER COUNTY, UTAH

REVISIONS	DESCRIPTION	DATE

Cover/Index Sheet



Centerline Curve Data

#	Delta	Radius	Length	Tangent	Chord	CH Length
C1	38°02'50"	150.00'	99.61'	51.72'	S17°27'11"E	97.79'

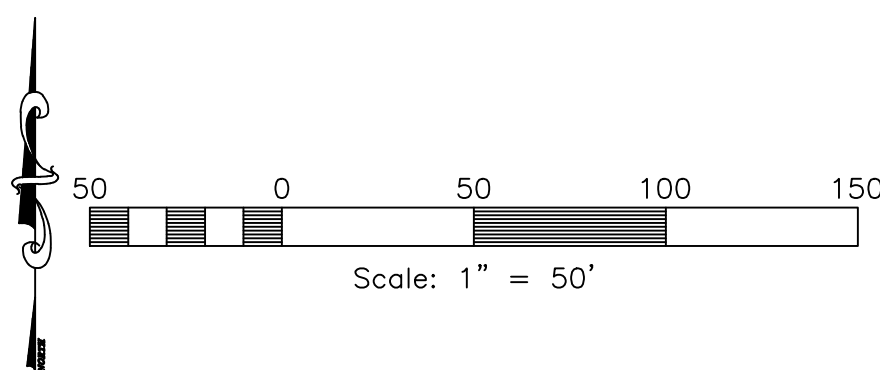

General Notes:

- ALL CONSTRUCTION MUST STRICTLY FOLLOW THE STANDARDS AND SPECIFICATIONS SET FORTH BY: GOVERNING UTILITY MUNICIPALITY, GOVERNING CITY OR COUNTY (IF UN-INCORPORATED), INDIVIDUAL PRODUCT MANUFACTURERS, AMERICAN PUBLIC WORKS ASSOCIATION (APWA), AND THE DESIGN ENGINEER. THE ORDER LISTED ABOVE IS ARRANGED BY SENIORITY, IF A CONSTRUCTION PRACTICE IS NOT SPECIFIED BY ANY OF THE LISTED SOURCES, CONTRACTOR MUST CONTACT DESIGN ENGINEER FOR DIRECTION.
- CONTRACTOR TO STRICTLY FOLLOW ALL RECOMMENDATIONS FOR THIS PROJECT, ALL GRADING INCLUDING BUT NOT LIMITED TO CUT, FILL, COMPACTION, ASPHALT SECTION, SUBBASE, TRENCH EXCAVATION/BACKFILL, SITE GRUBBING, RETAINING WALLS AND FOOTINGS MUST BE COORDINATED DIRECTLY WITH THE PROJECT GEOTECHNICAL ENGINEER.
- TRAFFIC CONTROL, STRIPING & SIGNAGE TO CONFORM TO CURRENT GOVERNING AGENCIES TRANSPORTATION ENGINEER'S MANUAL AND MANUAL OF UNIFORM TRAFFIC CONTROL DEVICES.
- ANY AREA OUTSIDE THE LIMIT OF WORK THAT IS DISTURBED SHALL BE RESTORED TO ITS ORIGINAL CONDITION AT NO COST TO OWNER.
- CONSULT ALL OF THE DRAWINGS AND SPECIFICATIONS FOR COORDINATION REQUIREMENTS BEFORE COMMENCING CONSTRUCTION.
- AT ALL LOCATIONS WHERE EXISTING PAVEMENT ABUTS NEW CONSTRUCTION, THE EDGE OF THE EXISTING PAVEMENT SHALL BE SAWCUT TO A CLEAN, SMOOTH EDGE.
- ALL CONSTRUCTION AND MATERIALS SHALL BE IN ACCORDANCE WITH THE MOST RECENT, ADOPTED EDITION OF ADA ACCESSIBILITY GUIDELINES.
- PRIOR TO STARTING CONSTRUCTION, THE CONTRACTOR SHALL BE RESPONSIBLE FOR MAKING SURE THAT ALL REQUIRED PERMITS AND APPROVALS HAVE BEEN OBTAINED. NO CONSTRUCTION OR FABRICATION SHALL BEGIN UNTIL THE CONTRACTOR HAS RECEIVED THOROUGHLY REVIEWED PLANS AND OTHER DOCUMENTS APPROVED BY ALL OF THE PERMITTING AUTHORITIES.
- CONTRACTOR IS RESPONSIBLE FOR SCHEDULING AND NOTIFYING ENGINEER OR INSPECTING AUTHORITY 48 HOURS IN ADVANCE OF COVERING UP ANY PHASE OF CONSTRUCTION REQUIRING OBSERVATION.
- ANY WORK IN THE PUBLIC RIGHT-OF-WAY WILL REQUIRE PERMITS FROM THE APPROPRIATE CITY, COUNTY OR STATE AGENCY CONTROLLING THE ROAD, INCLUDING OBTAINING REQUIRED INSPECTIONS.
- ALL DIMENSIONS, GRADES & UTILITY DESIGNS SHOWN ON THE PLANS SHALL BE VERIFIED BY THE CONTRACTOR PRIOR TO CONSTRUCTION. CONTRACTOR SHALL NOTIFY ENGINEER OF ANY DISCREPANCIES PRIOR TO PROCEEDING WITH CONSTRUCTION FOR NECESSARY PLAN OR GRADE CHANGES.
- CONTRACTOR MUST VERIFY ALL EXISTING CONDITIONS BEFORE BIDDING AND BRING UP ANY QUESTIONS BEFOREHAND.
- SITE GRADING SHALL BE PERFORMED IN ACCORDANCE WITH THESE PLANS AND SPECIFICATIONS AND THE RECOMMENDATIONS SET FORTH BY THE GEOTECHNICAL ENGINEER.
- CATCH SLOPES SHALL BE GRADED ON GRADING PLANS.
- CONTRACTOR SHALL BE RESPONSIBLE FOR ALL FLAGGING, CAUTION SIGNS, LIGHTS, BARRICADES, FLAGMEN, AND ALL OTHER DEVICES NECESSARY FOR PUBLIC SAFETY.
- CONTRACTOR SHALL, AT THE TIME OF BIDDING AND THROUGHOUT THE PERIOD OF THE CONTRACT, BE LICENSED IN THE STATE WHERE THE PROJECT IS LOCATED AND SHALL BE BONDABLE FOR AN AMOUNT EQUAL TO OR GREATER THAN THE AMOUNT BID AND TO DO THE TYPE OF WORK CONTEMPLATED IN THE PLANS AND SPECIFICATIONS. CONTRACTOR SHALL BE SKILLED AND REGULARLY ENGAGED IN THE GENERAL CLASS AND TYPE OF WORK CALLED FOR IN THE PLANS AND SPECIFICATIONS.
- CONTRACTOR SHALL INSPECT THE SITE OF THE WORK PRIOR TO BIDDING TO SATISFY HIMSELF BY PERSONAL EXAMINATION OR BY SUCH OTHER MEANS AS HE MAY PREFER OF THE LOCATION OF THE PROPOSED WORK AND OF THE ACTUAL CONDITIONS OF AND AT THE SITE OF WORK. IF, DURING THE COURSE OF HIS EXAMINATION, A BIDDER FINDS FACTS OR CONDITIONS WHICH APPEAR TO HIM TO BE IN CONFLICT WITH THE LETTER OR SPIRIT OF THE PROJECT PLANS AND SPECIFICATIONS, HE SHALL CONTACT THE ENGINEER FOR ADDITIONAL INFORMATION AND EXPLANATION BEFORE SUBMITTING HIS BID. SUBMISSION OF A BID BY THE CONTRACTOR SHALL CONSTITUTE ACKNOWLEDGMENT THAT, IF AWARDED THE CONTRACT, HE HAS RELIED AND IS RELYING ON HIS OWN EXAMINATION OF (1) THE SITE OF THE WORK, (2) ACCESS TO THE SITE, AND (3) ALL OTHER DATA AND MATTERS REQUISITE TO THE FULFILLMENT OF THE WORK AND ON HIS OWN KNOWLEDGE OF EXISTING FACILITIES ON AND IN THE VICINITY OF THE SITE OF THE WORK TO BE CONSTRUCTED UNDER THIS CONTRACT. THE INFORMATION PROVIDED BY THE ENGINEER IS NOT INTENDED TO BE A SUBSTITUTE FOR, OR A SUPPLEMENT TO, THE INDEPENDENT VERIFICATION BY THE CONTRACTOR TO THE EXTENT SUCH INDEPENDENT INVESTIGATION OF SITE CONDITIONS IS DEEMED NECESSARY OR DESIRABLE BY THE CONTRACTOR. CONTRACTOR SHALL ACKNOWLEDGE THAT HE HAS NOT RELIED SOLELY UPON OWNER- OR ENGINEER-FURNISHED INFORMATION REGARDING SITE CONDITIONS IN PREPARING AND SUBMITTING HIS BID.
- CONTRACTOR SHALL BE RESPONSIBLE TO PROVIDE ALL WATER, POWER, SANITARY FACILITIES AND TELEPHONE SERVICES AS REQUIRED FOR THE CONTRACTOR'S USE DURING CONSTRUCTION.
- CONTRACTOR SHALL BE HELD RESPONSIBLE FOR ANY FIELD CHANGES MADE WITHOUT PRIOR WRITTEN AUTHORIZATION FROM THE OWNER, ENGINEER, AND/OR GOVERNING AGENCIES.
- CONTRACTOR SHALL EXERCISE DUE CAUTION AND SHALL CAREFULLY PRESERVE BENCH MARKS, CONTROL POINTS, REFERENCE POINTS AND ALL SURVEY STAKES, AND SHALL BEAR ALL EXPENSES FOR REPLACEMENT AND/OR ERRORS CAUSED BY THEIR UNNECESSARY LOSS OR DISTURBANCE.
- CONTRACTOR SHALL ASSUME SOLE AND COMPLETE RESPONSIBILITY FOR JOBSITE CONDITIONS DURING THE COURSE OF CONSTRUCTION OF THIS PROJECT, INCLUDING SAFETY OF ALL PERSONS AND PROPERTY. THIS REQUIREMENT SHALL APPLY CONTINUOUSLY AND NOT BE LIMITED TO NORMAL WORKING HOURS. THE CONTRACTOR SHALL DEFEND, INDEMNIFY AND HOLD THE OWNER AND ENGINEER HARMLESS FROM ANY AND ALL LIABILITY, REAL OR ALLEGED, IN CONNECTION WITH THE PERFORMANCE OF WORK ON THIS PROJECT, EXCEPTING FOR LIABILITY ARISING FROM THE SOLE NEGLIGENCE OF THE OWNER OR THE ENGINEER.
- CONTRACTOR SHALL BE RESPONSIBLE FOR ADEQUATELY SCHEDULING INSPECTION AND TESTING OF ALL FACILITIES CONSTRUCTED UNDER THIS CONTRACT. ALL TESTING SHALL CONFORM TO THE REGULATORY AGENCY'S STANDARD SPECIFICATIONS. ALL TESTING AND INSPECTION SHALL BE PAID FOR BY THE OWNER; ALL RE-TESTING AND/OR RE-INSPECTION SHALL BE PAID FOR BY THE CONTRACTOR.
- IF EXISTING IMPROVEMENTS NEED TO BE DISTURBED AND/OR REMOVED FOR THE PROPER PLACEMENT OF IMPROVEMENTS TO BE CONSTRUCTED BY THESE PLANS, THE CONTRACTOR SHALL BE RESPONSIBLE FOR PROTECTING EXISTING IMPROVEMENTS FROM DAMAGE. COST OF REPLACING OR REPAIRING EXISTING IMPROVEMENTS SHALL BE INCLUDED IN THE UNIT PRICE BID FOR ITEMS REQUIRING REMOVAL AND/OR REPLACEMENT. THERE WILL BE NO EXTRA COST DUE TO THE CONTRACTOR FOR REPLACING OR REPAIRING EXISTING IMPROVEMENTS.
- WHENEVER EXISTING FACILITIES ARE REMOVED, DAMAGED, BROKEN, OR CUT IN THE INSTALLATION OF THE WORK COVERED BY THESE PLANS OR SPECIFICATIONS, SAID FACILITIES SHALL BE REPLACED AT THE CONTRACTOR'S EXPENSE WITH MATERIALS EQUAL TO OR BETTER THAN THE MATERIALS USED IN THE ORIGINAL EXISTING FACILITIES. THE FINISHED PRODUCT SHALL BE SUBJECT TO THE APPROVAL OF THE OWNER, THE ENGINEER, AND THE RESPECTIVE REGULATORY AGENCY.
- CONTRACTOR SHALL MAINTAIN A NEATLY MARKED SET OF FULL-SIZE AS-BUILT RECORD DRAWINGS SHOWING THE FINAL LOCATION AND LAYOUT OF ALL STRUCTURES AND OTHER FACILITIES. AS-BUILT RECORD DRAWINGS SHALL REFLECT CHANGE ORDERS, ACCOMMODATIONS, AND ADJUSTMENTS TO ALL IMPROVEMENTS CONSTRUCTED, WHERE NECESSARY. SUPPLEMENTAL DRAWINGS SHALL BE PREPARED AND SUBMITTED BY THE CONTRACTOR. PRIOR TO ACCEPTANCE OF THE PROJECT, THE CONTRACTOR SHALL DELIVER TO THE ENGINEER ONE SET OF NEATLY MARKED AS-BUILT RECORD DRAWINGS SHOWING THE INFORMATION REQUIRED ABOVE. AS-BUILT RECORD DRAWINGS SHALL BE REVIEWED AND THE COMPLETE AS-BUILT RECORD DRAWING SET SHALL BE CURRENT WITH ALL CHANGES AND DEVIATIONS REDEFINED AS A PRECONDITION TO THE FINAL PROGRESS PAYMENT APPROVAL AND/OR FINAL ACCEPTANCE.
- WHERE THE PLANS OR SPECIFICATIONS DESCRIBE PORTIONS OF THE WORK IN GENERAL TERMS BUT NOT IN COMPLETE DETAIL, IT IS UNDERSTOOD THAT ONLY THE BEST GENERAL PRACTICE IS TO PREVAIL AND THAT ONLY WORKMANSHIP OF THE HIGHEST QUALITY ARE TO BE USED.
- CONTRACTOR SHALL BE SKILLED AND REGULARLY ENGAGED IN THE GENERAL CLASS AND TYPE OF WORK CALLED FOR IN THE PROJECT PLANS AND SPECIFICATIONS. THEREFORE, THE OWNER IS RELYING UPON THE EXPERIENCE AND EXPERTISE OF THE CONTRACTOR. PRICES PROVIDED WITHIN THE CONTRACT DOCUMENTS SHALL INCLUDE ALL LABOR AND MATERIALS NECESSARY AND PROPER FOR THE WORK CONTEMPLATED AND THAT THE WORK BE COMPLETED IN ACCORDANCE WITH THE TRUE INTENT AND PURPOSE OF THESE PLANS AND SPECIFICATIONS. THE CONTRACTOR SHALL BE COMPETENT, KNOWLEDGEABLE AND HAVE SPECIAL SKILLS IN THE NATURE, EXTENT AND INHERENT CONDITIONS OF THE WORK TO BE PERFORMED. CONTRACTOR SHALL ALSO ACKNOWLEDGE THAT THERE ARE CERTAIN PECULIAR AND INHERENT CONDITIONS EXISTENT IN THE CONSTRUCTION OF THE PARTICULAR FACILITIES WHICH MAY CREATE, DURING THE CONSTRUCTION PROGRAM, UNUSUAL OR UNSAFE CONDITIONS HAZARDOUS TO PERSONS, PROPERTY AND THE ENVIRONMENT. CONTRACTOR SHALL BE AWARE OF SUCH PECULIAR RISKS AND HAVE THE SKILL AND EXPERIENCE TO FORESEE AND TO ADOPT PROTECTIVE MEASURES TO ADEQUATELY AND SAFELY PERFORM THE CONSTRUCTION WORK WITH RESPECT TO SUCH HAZARDS.
- CONTRACTOR SHALL BE RESPONSIBLE FOR THE REMOVAL OF ALL STRIPING AND/OR PAVEMENT MARKINGS NECESSARY TO THE EXISTING STRIPING INTO FUTURE STRIPING. METHOD OF REMOVAL SHALL BE BY GRINDING OR SANDBLASTING.
- CONTRACTOR SHALL PROVIDE ALL SHORING, BRACING, SLOPING OR OTHER PROVISIONS NECESSARY TO PROTECT WORKMEN FOR ALL AREAS TO BE EXCAVATED TO A DEPTH OF 4 FEET OR MORE. FOR EXCAVATIONS 4 FEET OR MORE IN DEPTH, THE CONTRACTOR SHALL COMPLY WITH LOCAL, STATE AND NATIONAL SAFETY CODES, ORDINANCES, OR REQUIREMENTS FOR EXCAVATION AND TRENCHES.
- ALL EXISTING GATES AND FENCES TO REMAIN UNLESS OTHERWISE NOTED ON PLANS. PROTECT ALL GATES AND FENCES FROM DAMAGE

Utility Notes:

- CONTRACTOR SHALL COORDINATE LOCATION OF NEW "DRY UTILITIES" WITH THE APPROPRIATE UTILITY COMPANY, INCLUDING BUT NOT LIMITED TO: TELEPHONE SERVICE, GAS SERVICE, CABLE, POWER, INTERNET.
- EXISTING UTILITIES HAVE BEEN SHOWN ON THE PLANS USING A COMBINATION OF ON-SITE SURVEYS (BY OTHERS), PRIOR TO COMMENCING ANY WORK, IT SHALL BE THE CONTRACTOR'S RESPONSIBILITY TO HAVE EACH UTILITY COMPANY LOCATE IN THE FIELD, THEIR MAIN AND SERVICE LINES 48 HOURS IN ADVANCE OF COMMENCING ANY EXCAVATION WORK. THE CONTRACTOR SHALL RECORD THE BLUE STAKES ORDER NUMBER AND FURNISH ORDER NUMBER TO OWNER AND ENGINEER PRIOR TO ANY EXCAVATION. IT WILL BE THE CONTRACTOR'S SOLE RESPONSIBILITY TO DIRECTLY CONTACT ANY OTHER UTILITY COMPANIES THAT ARE NOT MEMBERS OF BLUE STAKES. IT SHALL BE THE CONTRACTOR'S SOLE RESPONSIBILITY TO PROTECT ALL EXISTING UTILITIES SO THAT NO DAMAGE RESULTS TO THEM DURING THE PERFORMANCE OF THIS CONTRACT. ANY REPAIRS NECESSARY TO DAMAGED UTILITIES SHALL BE PAID FOR BY THE CONTRACTOR. THE CONTRACTOR SHALL BE REQUIRED TO COOPERATE WITH OTHER CONTRACTORS AND UTILITY COMPANIES INSTALLING NEW STRUCTURES, UTILITIES AND SERVICE TO THE PROJECT.
- CONTRACTOR SHALL POT HOLE ALL UTILITIES TO DETERMINE IF CONFLICTS EXIST PRIOR TO BEGINNING ANY EXCAVATION. NOTIFY ENGINEER OF ANY CONFLICTS. CONTRACTOR SHALL VERIFY LOCATION AND INVERTS OF EXISTING UTILITIES TO WHICH NEW UTILITIES WILL BE CONNECTED. PRIOR TO COMMENCING ANY EXCAVATION WORK THE CONTRACTOR SHALL NOTIFY ALL UTILITY COMPANIES IN ACCORDANCE WITH THE REQUIRED PROCEDURES.
- CARE SHOULD BE TAKEN IN ALL EXCAVATIONS DUE TO POSSIBLE EXISTENCE OF UNRECORDED UTILITY LINES. EXCAVATION REQUIRED WITHIN PROXIMITY OF EXISTING UTILITY LINES SHALL BE DONE BY HAND. CONTRACTOR SHALL REPAIR ANY DAMAGE TO EXISTING UTILITY LINES OR STRUCTURES INCURRED DURING CONSTRUCTION OPERATIONS AT HIS EXPENSE.
- ALL VALVES AND MANHOLE COVERS SHALL BE RAISED OR LOWERED TO MEET FINISHED GRADE.
- CONTRACTOR SHALL CUT PIPES OFF FLUSH WITH THE INSIDE WALL OF THE BOX OR MANHOLE.
- CONTRACTOR SHALL GROUT AT CONNECTION OF PIPE TO BOX WITH NON-SHRINKING GROUT, INCLUDING PIPE VOIDS LEFT BY CUTTING PROCESS, TO A SMOOTH FINISH.
- CONTRACTOR SHALL GROUT WITH NON-SHRINK GROUT BETWEEN GRADE RINGS AND BETWEEN BOTTOM OF INLET LID FRAME AND TOP OF CONCRETE BOX
- SILT AND DEBRIS IS TO BE CLEANED OUT OF ALL STORM DRAIN BOXES. CATCH BASINS ARE TO BE MAINTAINED IN A CLEANED CONDITION AS NEEDED UNTIL AFTER THE FINAL BOND RELEASE INSPECTION.
- CONTRACTOR SHALL CLEAN ASPHALT, TAR OR OTHER ADHESIVES OFF OF ALL MANHOLE LIDS AND INLET GRATES TO ALLOW ACCESS.
- EACH TRENCH SHALL BE EXCAVATED SO THAT THE PIPE CAN BE LAID TO THE ALIGNMENT AND GRADE AS REQUIRED. THE TRENCH WALL SHALL BE SO BRACED THAT THE WORKMEN MAY WORK SAFELY AND EFFICIENTLY; ALL TRENCHES SHALL BE DRAINED SO THE PIPE LAYING MAY TAKE PLACE IN DE-WATERED CONDITIONS.
- CONTRACTOR SHALL PROVIDE AND MAINTAIN AT ALL TIMES AMPLE MEANS AND DEVICES WITH WHICH TO REMOVE PROMPTLY AND TO PROPERLY DISPOSE OF ALL WATER ENTERING THE TRENCH EXCAVATION.
- MAINTAIN A MINIMUM 18" VERTICAL SEPARATION DISTANCE BETWEEN ALL UTILITY CROSSINGS.
- CONTRACTOR SHALL START INSTALLATION AT LOW POINT OF ALL NEW GRAVITY UTILITY LINES.
- ALL BOLTED FITTINGS MUST BE GREASED AND WRAPPED.
- UNLESS SPECIFICALLY NOTED OTHERWISE, MAINTAIN AT LEAST 2 FEET OF COVER OVER ALL STORM DRAIN LINES AT ALL TIMES (INCLUDING DURING CONSTRUCTION).
- ALL WATER LINES SHALL BE INSTALLED A MINIMUM OF 48" BELOW FINISHED GRADE.
- ALL SEWER LINES AND SEWER SERVICES SHALL HAVE A MINIMUM SEPARATION OF 10 FEET, PIPE EDGE TO PIPE EDGE, FROM THE WATER LINES. IF A 10 FOOT SEPARATION CAN NOT BE MAINTAINED, THE SEWER LINE AND WATER LINE SHALL BE LAID IN SEPARATE TRENCHES AND THE BOTTOM OF THE WATER LINE SHALL BE AT LEAST 18" ABOVE THE TOP OF THE SEWER LINE.
- CONTRACTOR SHALL INSTALL THRUST BLOCKING AT ALL WATERLINE ANGLE POINTS AND TEES.
- ALL UNDERGROUND UTILITIES SHALL BE IN PLACE PRIOR TO INSTALLATION OF CURB, GUTTER, SIDEWALK AND STREET PAVING.
- CONTRACTOR SHALL INSTALL MAGNETIC LOCATING TAPE CONTINUOUSLY OVER ALL NONMETALLIC PIPE.

Stormwater Pollution Prevention Plan (SWPPP) General Notes:

THE CONTRACTOR SHALL COMPLETE ALL PAPERWORK, TEXT AND APPLICATIONS FOR THE SWPPP INCLUDING THE OBTAINING OF A NOTICE OF INTENT (NOI) FROM THE UTAH STATE DEPARTMENT OF WATER QUALITY.

THE CONTRACTOR SHALL SUBMIT THE COMPLETED SWPPP WITH APPLICATION FOR A STORM WATER CONSTRUCTION ACTIVITY PERMIT FROM THE WEBER COUNTY ENGINEERING DEPARTMENT.

THE CONTRACTOR TO USE BEST MANAGEMENT PRACTICES FOR PROVIDING EROSION CONTROL FOR CONSTRUCTION OF THIS PROJECT. ALL MATERIAL AND WORKMANSHIP SHALL CONFORM TO GOVERNING AGENCIES ORDINANCES AND ALL WORK SHALL BE SUBJECT TO INSPECTION BY THE COUNTIES. ALSO, INSPECTORS WILL HAVE THE RIGHT TO CHANGE THE FACILITIES AS NEEDED.

CONTRACTOR SHALL KEEP THE SITE WATERED TO CONTROL DUST. CONTRACTOR TO LOCATE A NEARBY HYDRANT FOR USE AND TO INSTALL TEMPORARY METER. CONSTRUCTION WATER COST TO BE INCLUDED IN BID.

WHEN GRADING OPERATIONS ARE COMPLETED AND THE DISTURBED GROUND IS LEFT "OPEN" FOR 14 DAYS OR MORE, THE AREA SHALL BE FURROWED PARALLEL TO THE CONTOURS.

THE CONTRACTOR SHALL MODIFY EROSION CONTROL MEASURES TO ACCOMMODATE PROJECT PLANNING.

ALL ACCESS TO PROPERTY WILL BE FROM PUBLIC RIGHT-OF-WAYS. THE CONTRACTOR IS REQUIRED BY STATE AND FEDERAL REGULATIONS TO PREPARE A STORM WATER POLLUTION PREVENTION PLAN AND FILE A "NOTICE OF INTENT" WITH THE GOVERNING AGENCIES.

SILT FENCE TO REMAIN UNTIL LANDSCAPING HAS BEEN INSTALLED FOR LOT & BASIN IMPROVEMENTS

Maintenance:

ALL BEST MANAGEMENT PRACTICES (BMP'S) SHOWN ON THIS PLAN MUST BE MAINTAINED AT ALL TIMES UNTIL ISSUANCE OF NOTICE OF TERMINATION (NOT) BY THE UTAH DEPARTMENT OF WATER QUALITY.

THE CONTRACTOR'S RESPONSIBILITY SHALL INCLUDE MAKING BI-WEEKLY CHECKS ON ALL EROSION CONTROL MEASURES TO DETERMINE IF REPAIR OR SEDIMENT REMOVAL IS NECESSARY. CHECKS SHALL BE DOCUMENTED AND COPIES OF THE INSPECTIONS KEPT ON SITE.

SEDIMENT DEPOSITS SHOULD BE REMOVED AFTER EACH RAINFALL. THEY MUST BE REMOVED WHEN THE LEVEL OF DEPOSITION REACHES APPROXIMATELY ONE-HALF THE HEIGHT OF BARRIER.

SEDIMENT TRACKED ONTO PAVED ROADS MUST BE CLEANED UP AS SOON AS PRACTICAL, BUT IN NO CASE LATER THAN THE END OF THE NORMAL WORK DAY. THE CLEAN UP WILL INCLUDE SWEEPING OF THE TRACKED MATERIAL, PICKING IT UP, AND DEPOSITING IT TO A CONTAINED AREA.

EXPOSED SLOPES:

- ANY EXPOSED SLOPE THAT WILL REMAIN UNTOUCHED FOR LONGER THAN 14 DAYS MUST BE STABILIZED BY ONE OR MORE OF THE FOLLOWING METHODS:
- SPRAYING DISTURBED AREAS WITH A TACKIFIER VIA HYDROSEED
 - TRACKING STRAW PERPENDICULAR TO SLOPES
 - INSTALLING A LIGHT-WEIGHT, TEMPORARY EROSION CONTROL BLANKET

Master Legend

— W — = PROPOSED CULINARY WATER LINE	□ = EXISTING CATCH BASIN	L.F. = LINEAR FEET
— EX.W — = EXISTING CULINARY WATER LINE	⊙ = MONUMENT	NG = NATURAL GRADE
— SS — = PROPOSED SANITARY SEWER LINE	⊕ = PLUG W/ 2" BLOW-OFF	O.C. = ON CENTER
— EX.SS — = EXISTING SANITARY SEWER LINE	⊖ = AIR-VAC ASSEMBLY	PC = POINT OF CURVE
— SD — = PROPOSED STORM DRAIN LINE	⊙ = PROPOSED REDUCER	PRC = POINT OF REVERSE CURVE
— EX.SD — = EXISTING STORM DRAIN LINE	⊕ = PLUG & BLOCK	PRVC = POINT OF REVERSE VERTICAL CURVE
— LD — = PROPOSED LAND DRAIN LINE	⊙ = STREET LIGHT	PT = POINT OF TANGENT
— EX.LD — = EXISTING LAND DRAIN LINE	⊕ = SIGN	PP = POWER/UTILITY POLE
— SW — = PROPOSED SECONDARY WATER LINE	⊕ = TRAFFIC SIGNAL	P.U.E. = PUBLIC UTILITY EASEMENT
— EX.SW — = EXISTING SECONDARY WATER LINE	BLDG = BUILDING	R/C = REBAR & CAP
— IRR — = PROPOSED IRRIGATION LINE	BVC = BEGIN VERTICAL CURVE	RCB = REINFORCED CONCRETE BOX
— EX.IRR — = EXISTING IRRIGATION LINE	C&G = CURB & GUTTER	RCP = REINFORCED CONCRETE PIPE
— OHP — = EXISTING OVERHEAD POWER LINE	CB = CATCH BASIN	RIM = RIM OF MANHOLE
— TEL — = EXISTING TELEPHONE LINE	C.F. = CUBIC FEET	R.O.W. = RIGHT-OF-WAY
— GAS — = EXISTING NATURAL GAS LINE	C.F.S. = CUBIC FEET PER SECOND	SD = STORM DRAIN
— = EXISTING EDGE OF PAVEMENT	CL = CENTERLINE	SS = SANITARY SEWER
⊗ ⊗ ⊗ = FENCE LINE	DI = DUCTILE IRON	SW = SECONDARY WATER
— = DITCH/SWALE FLOWLINE	EP = EDGE OF PAVEMENT	TBC = TOP BACK OF CURB
● = PROPOSED FIRE HYDRANT	EVC = END VERTICAL CURVE	TOE = TOE OF SLOPE
○ = EXISTING FIRE HYDRANT	FC = FENCE CORNER	TOP = TOP OF SLOPE
● = PROPOSED MANHOLE	FF = FINISH FLOOR	TOW = TOP OF WALL
○ = EXISTING MANHOLE	FFE = FINISH FLOOR ELEVATION	TSW = TOP OF SIDEWALK
● = PROPOSED SEWER CLEAN-OUT	FG = FINISHED GRADE	VPI = VERTICAL POINT OF INTERSECT.
⊗ = PROPOSED GATE VALVE	FH = FIRE HYDRANT	W = CULINARY WATER
⊗ = EXISTING GATE VALVE	FL = FLOW LINE	WM = WATER METER
⊗ = PROPOSED WATER METER	GB = GRADE BREAK	■ = NEW PAVEMENT
⊗ = EXISTING WATER METER	HDPE = HIGH DENSITY POLYETHYLENE PIPE	■ = NEW CONCRETE
⊗ = PROPOSED CATCH BASIN	INV = INVERT	□ = EXIST PAVEMENT
⊗ = PROPOSED SURVEY MONUMENT	IRR = IRRIGATION	
	LD = LAND DRAIN	

UTILITY CONTACT INFORMATION:

QUESTAR GAS:	800-323-5517
ROCKY MOUNTAIN POWER:	888-221-7070
CENTURY LINK:	877-348-9007
HOOPER IRRIGATION:	801-985-8429
WEST WEBER/TAYLOR WATER IMPROVEMENT DISTRICT:	801-731-1668
COMCAST:	800-934-6489
WEBER COUNTY (STORM DRAIN)	801-399-8374

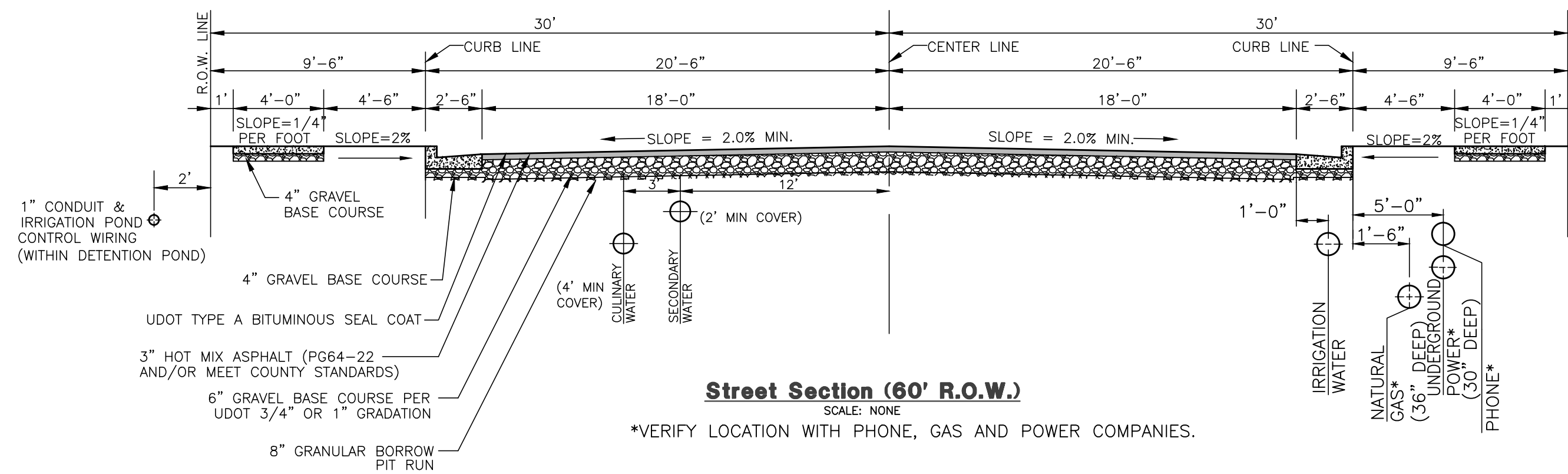

REVISIONS	DESCRIPTION	DATE

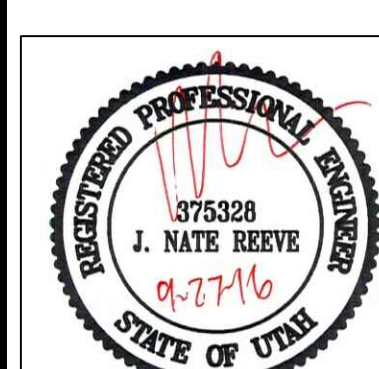

Project Info.
Engineer: J. NATE REEVE
Drafted: C. KINGSLEY
Begin Date: NOVEMBER, 2015
Name: HENRY FLATS CLUSTER SUBDIVISION
Number: 6272-01

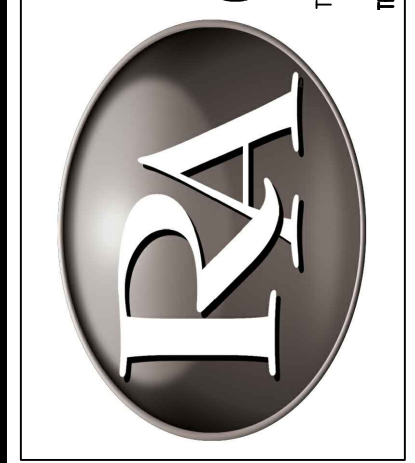

REVISIONS	DESCRIPTION
DATE	

REVISIONS	DESCRIPTION
DATE	

Revised: 09-27-16

Henry Flats Cluster Subdivision
 WEBER COUNTY, UTAH

4350 WEST STREET
10+50.00 - 14+00.00

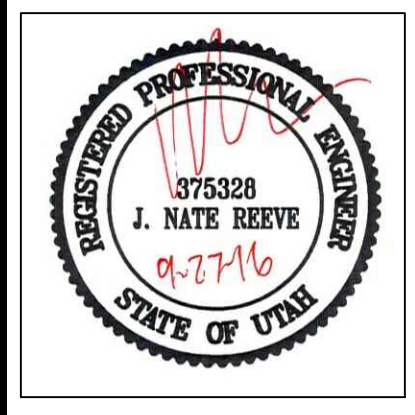

Project Info.
 Engineer: J. NATE REEVE
 Drafter: C. KINGSLEY
 Begin Date: NOVEMBER, 2015
 Name: HENRY FLATS CLUSTER SUBDIVISION
 Number: 6272-01

Construction Notes:

- 1) ALL CONSTRUCTION IS TO CONFORM TO THE STANDARD DRAWINGS AND SPECIFICATIONS OF WEBER COUNTY & MANUAL OF STANDARD PLANS 2012 PUBLISHED BY APWA. WHEN IN CONFLICT, SEEK CLARIFICATION FROM WEBER COUNTY ENGINEERING DEPT.
- 2) PROVIDE FULL DEPTH EXPANSION JOINT FOR FUTURE CURB & GUTTER REMOVAL.
- 3) PROVIDE DRIVEWAY APRON PER APWA STD. #225. SAWCUT FOR FUTURE APPROACHES WHEN FUTURE HOMES ARE BUILT. DOWEL INTO EXISTING IMPROVEMENTS.

- CULINARY WATER**
 W/8 - 8" PVC C-900 CLASS 200 WATER W - 1" TYPE K COPPER SERVICE LATERAL
- SANITARY SEWER**
 EACH LOT TO HAVE INDIVIDUAL SEPTIC SYSTEM
- STORM DRAIN**
 SD/18 - 18" RCP STORM DRAIN (CLASS III)
- SECONDARY WATER**
 SW/6 - 6" PVC C-900 SECONDARY WATER LINE
 IRR/12 - 12" ASTM D3034 SDR 35 IRRIGATION LINE
 SW - (DOUBLE SERVICE) 1.5" CTS HDPE PIPE SERVICE LATERAL
 SW - (SINGLE SERVICE) 1" CTS HDPE PIPE SERVICE LATERAL

Centerline Curve Data

#	Delta	Radius	Length	Tangent	Chord	CH Length
C1	38°02'50"	150.00'	99.61'	51.72'	S17°27'11"E	97.79'

TBC Curve Data

#	Delta	Radius	Length	Tangent	Chord	CH Length
C3	38°02'50"	129.50'	85.99'	44.65'	N17°27'11"W	84.42'
C4	90°00'00"	20.00'	31.42'	20.00'	N46°34'14"E	28.28'
C5	90°00'00"	20.00'	31.42'	20.00'	S43°25'46"E	28.28'
C6	38°02'50"	170.50'	113.22'	58.79'	N17°27'11"W	111.15'

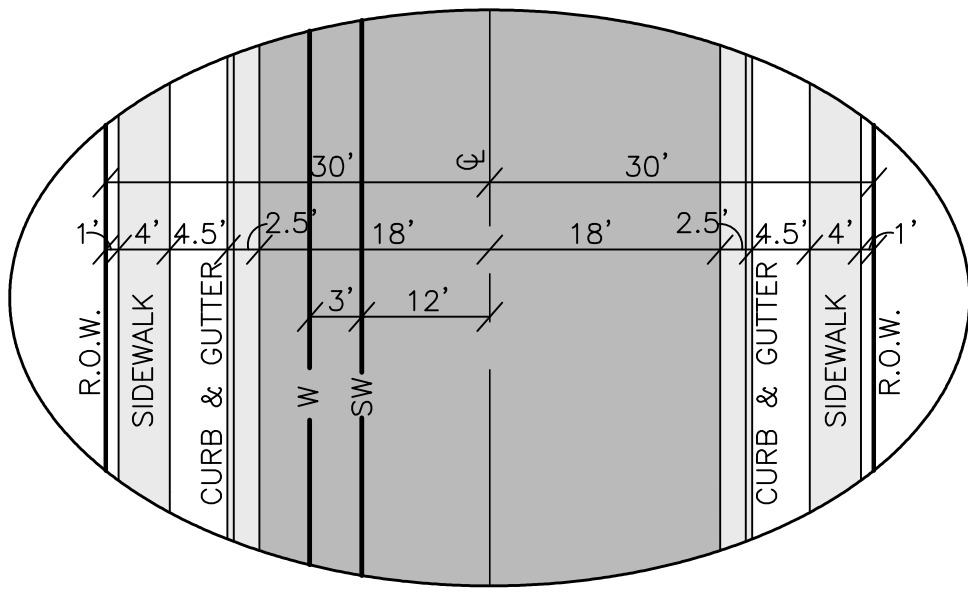
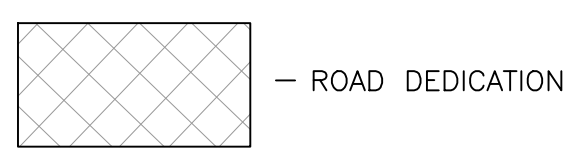

Street Dimensions
 LOOKING UP-STATION

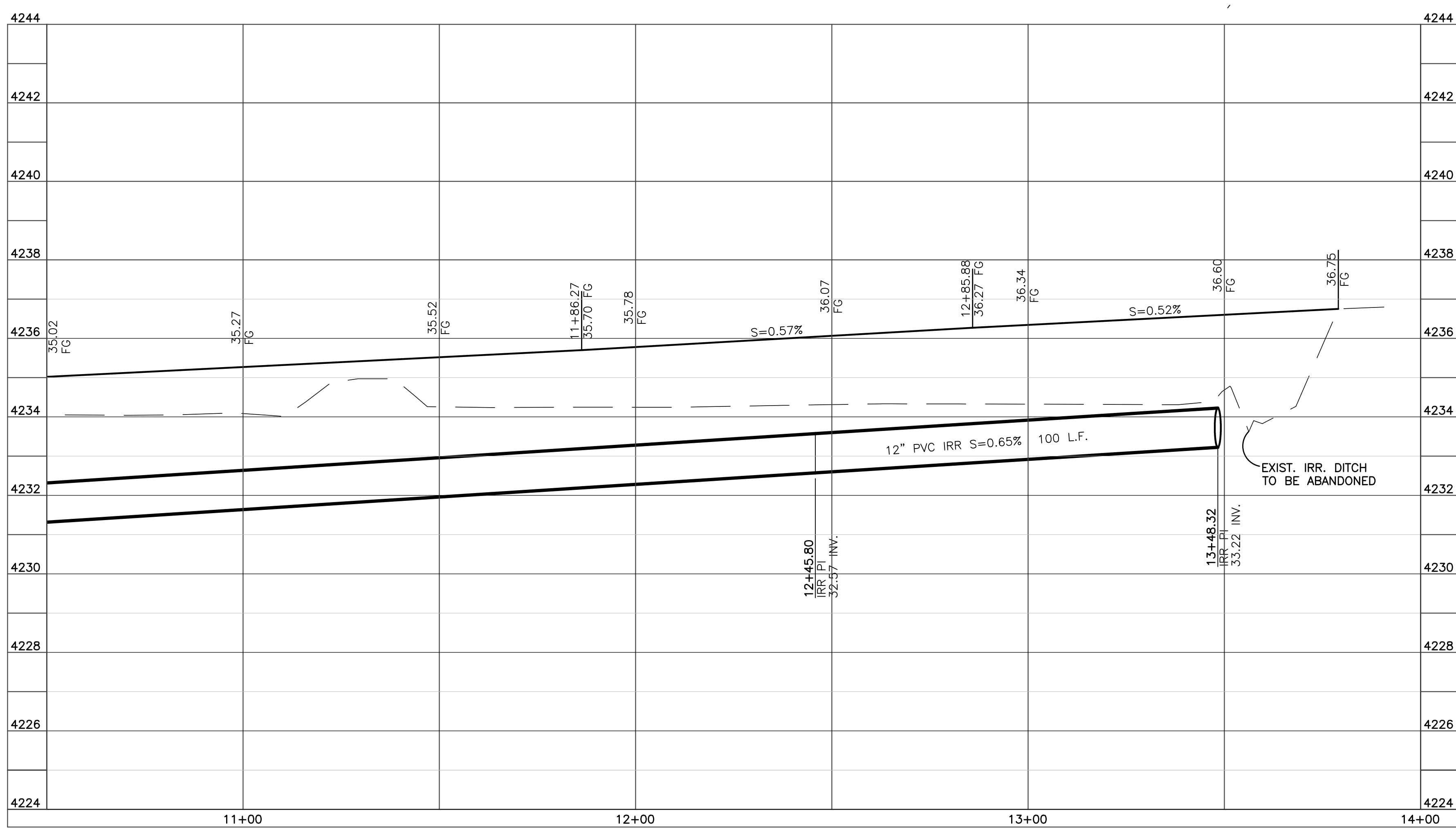
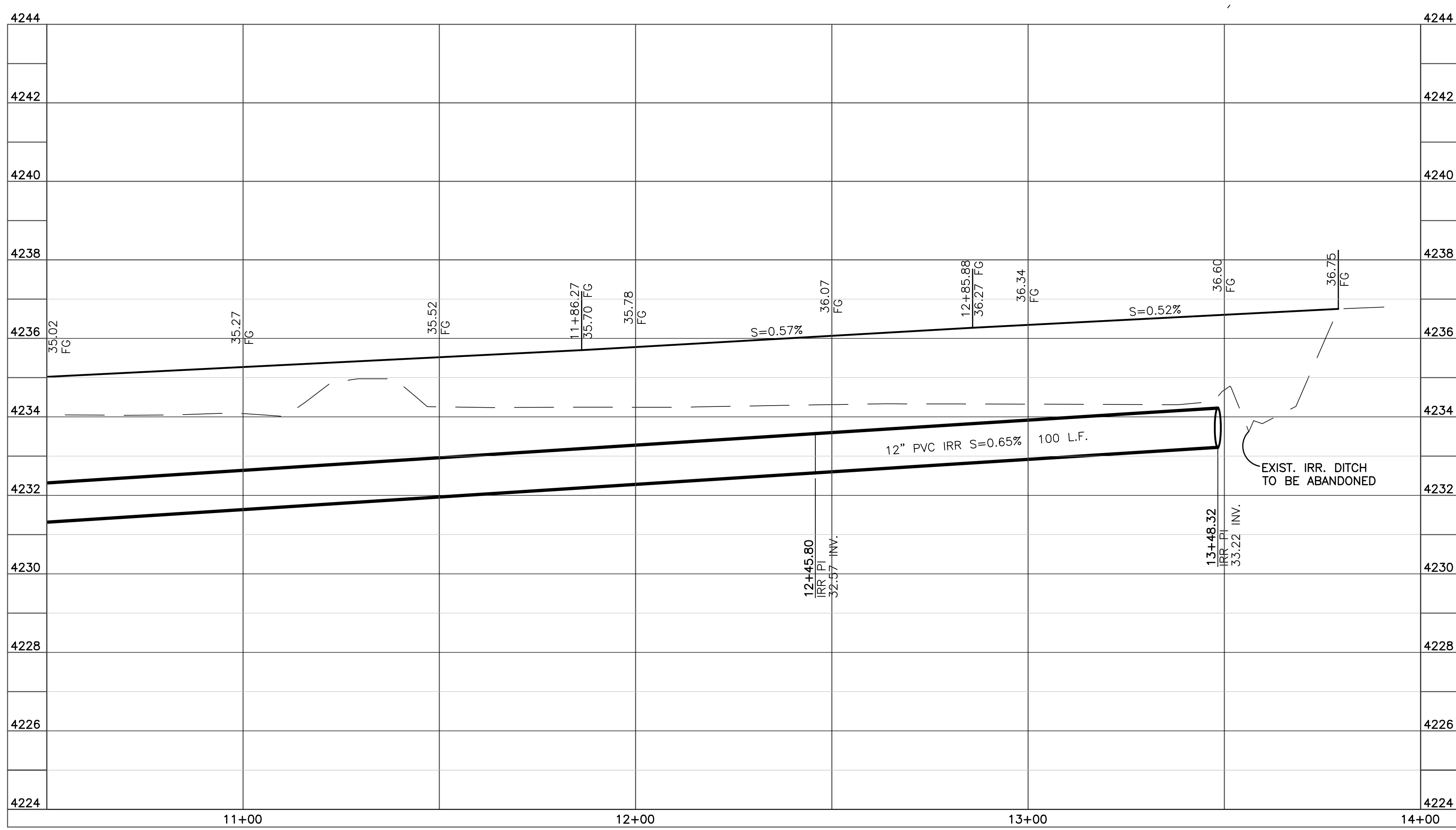
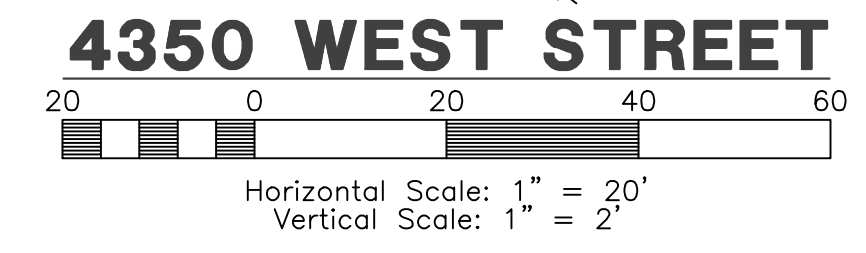

Blue Stakes Location Center
Call: Toll Free
1-800-662-4111
 Two Working Days Before You Dig

Reeve & Associates, Inc. - Solutions You Can Build On

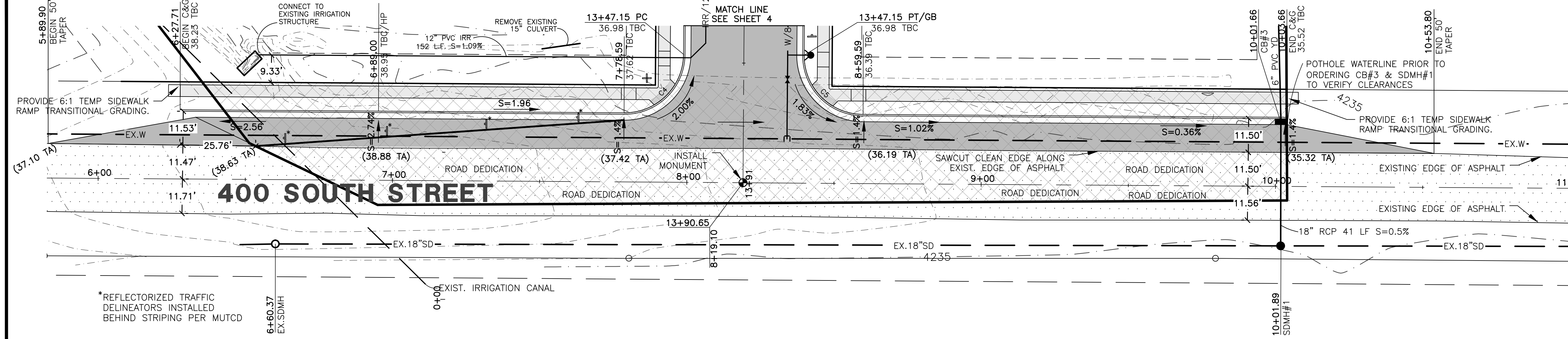

*REFLECTORIZED TRAFFIC DELINEATORS INSTALLED BEHIND STRIPING PER MUTCD

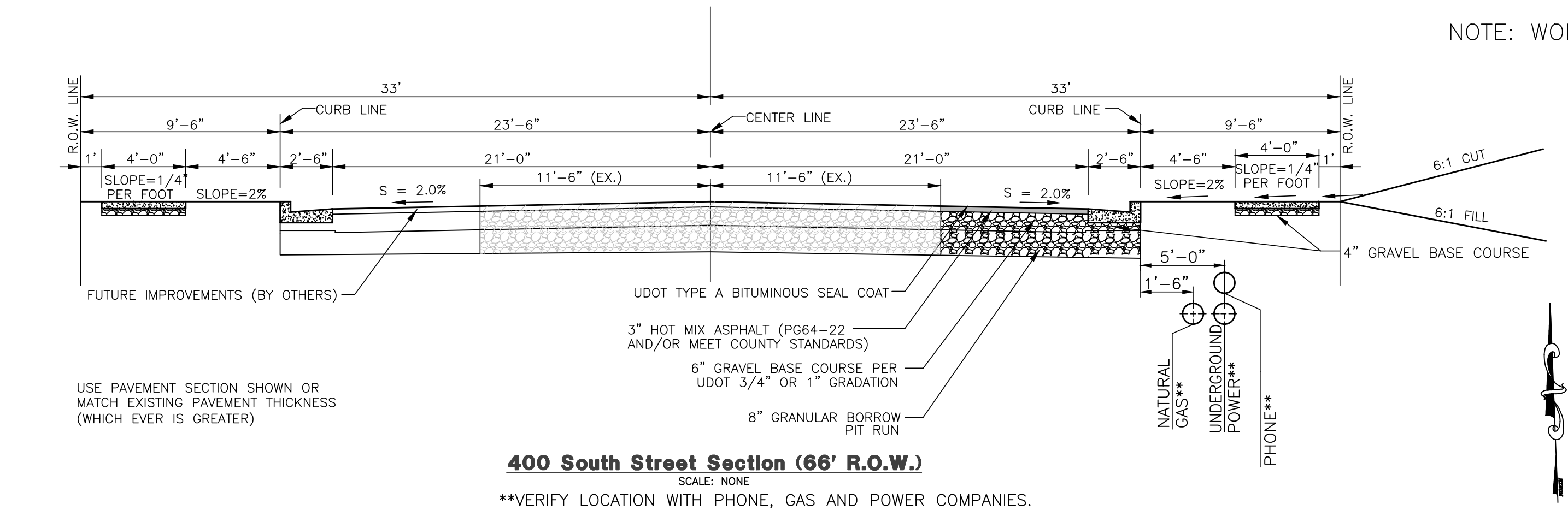

NOTE: WORK WITHIN 400 SOUTH STREET WILL REQUIRE EXCAVATION PERMIT.

Key Map NOT TO SCALE

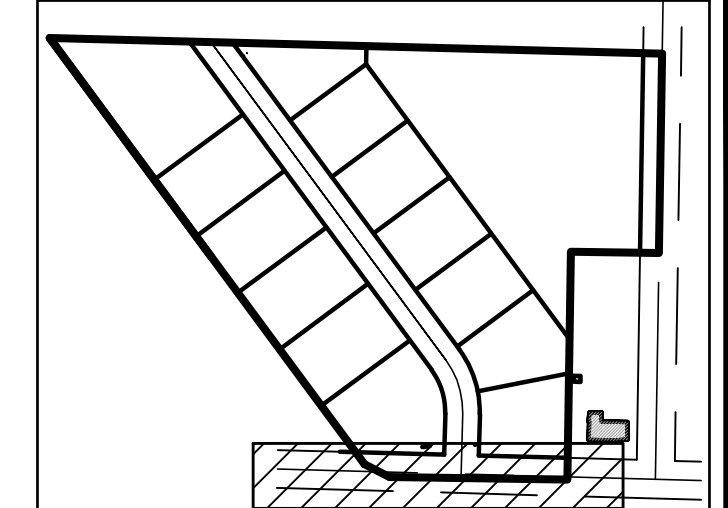

Construction Notes:

- ALL CONSTRUCTION IS TO CONFORM TO THE STANDARD DRAWINGS AND SPECIFICATIONS OF WEBER COUNTY & MANUAL OF STANDARD PLANS 2012 PUBLISHED BY APWA. WHEN IN CONFLICT, SEEK CLARIFICATION FROM WEBER COUNTY ENGINEERING DEPT.
- PROVIDE FULL DEPTH EXPANSION JOINT FOR FUTURE CURB & GUTTER REMOVAL.
- PROVIDE DRIVEWAY APRON PER APWA STD. #225. SAWCUT FOR FUTURE APPROACHES WHEN FUTURE HOMES ARE BUILT. DOWEL INTO EXISTING IMPROVEMENTS.

- CULINARY WATER**
W/8 - 8" PVC C-900 CLASS 200 WATER
W - 1" TYPE K COPPER SERVICE LATERAL
- SANITARY SEWER**
EACH LOT TO HAVE INDIVIDUAL SEPTIC SYSTEM
- STORM DRAIN**
SD/18 - 18" RCP STORM DRAIN (CLASS III)
- SECONDARY WATER**
SW/6 - 6" PVC C-900 SECONDARY WATER LINE
IRR/12 - 12" ASTM D3034 SDR 35 IRRIGATION LINE
SW - (DOUBLE SERVICE) 1.5" CTS HDPE PIPE SERVICE LATERAL
SW - (SINGLE SERVICE) 1" CTS HDPE PIPE SERVICE LATERAL

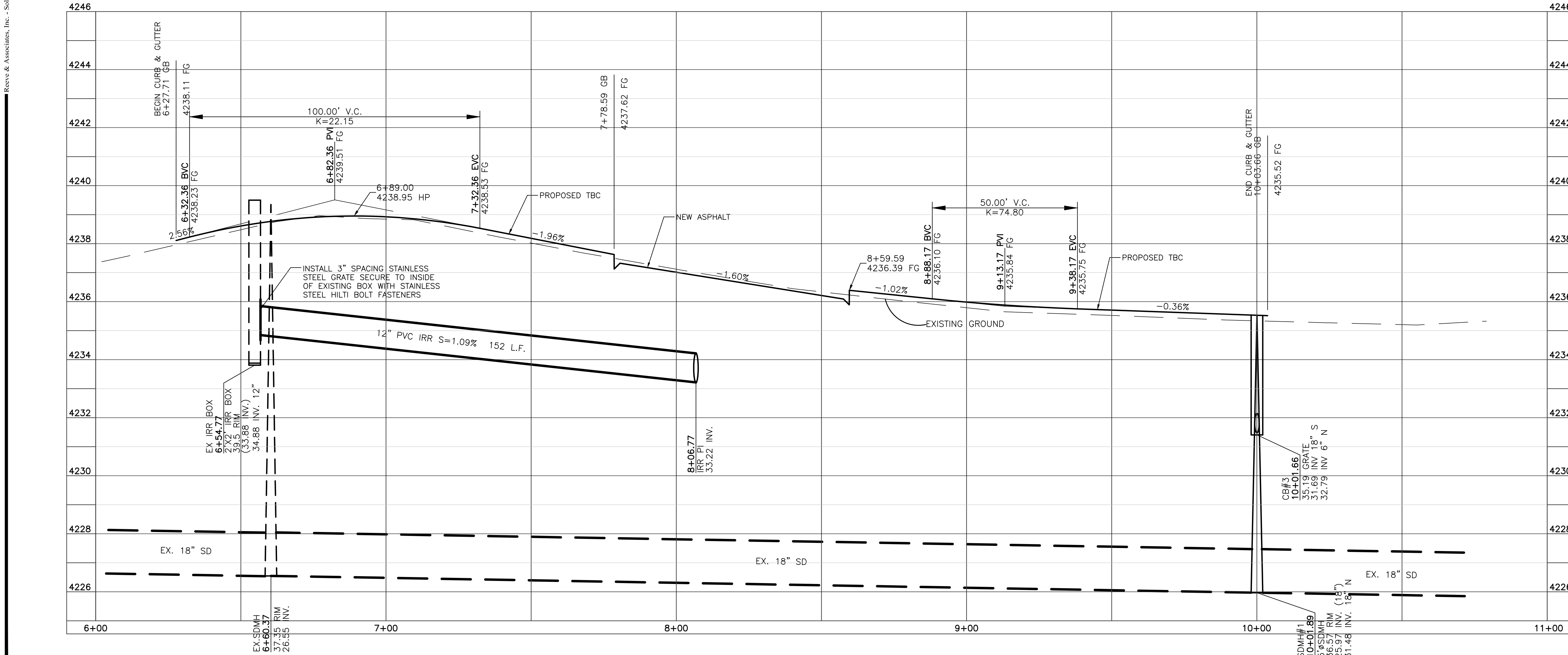
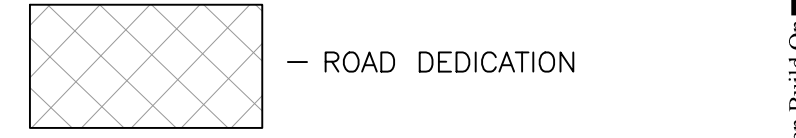

Blue Stakes Location Center
Call: Toll Free 1-800-662-4111
Two Working Days Before You Dig

Reeve & Associates, Inc.
5160 SOUTH 1500 WEST RIVERDALE, UTAH 84405
TEL: (801) 621-3100 FAX: (801) 621-2666 www.reeve-assoc.com
LAND PLANNERS • CIVIL ENGINEERS • LAND SURVEYORS
TRAFFIC ENGINEERS • STRUCTURAL ENGINEERS • LANDSCAPE ARCHITECTS

IRA

REVISIONS	DESCRIPTION

Henry Flats Cluster Subdivision
WEBER COUNTY, UTAH
400 South Street
6+00.00 - 11+00.00

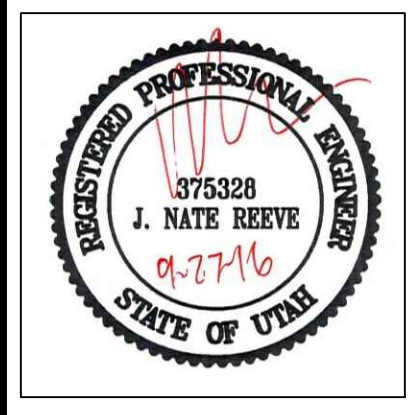

Project Info.
Engineer: J. NATE REEVE
Drafted: C. KINGSLEY
Begin Date: NOVEMBER, 2015
Name: HENRY FLATS CLUSTER SUBDIVISION
Number: 6272-01

Sheet **12**
5 Sheets

Revised: 09-27-16

Reeve & Associates, Inc. - Solutions You Can Build On

NOTE: ROOF DRAINS FROM LOTS 2, 3, 4, 5, & 6 TO DRAIN TOWARDS THE STREET.

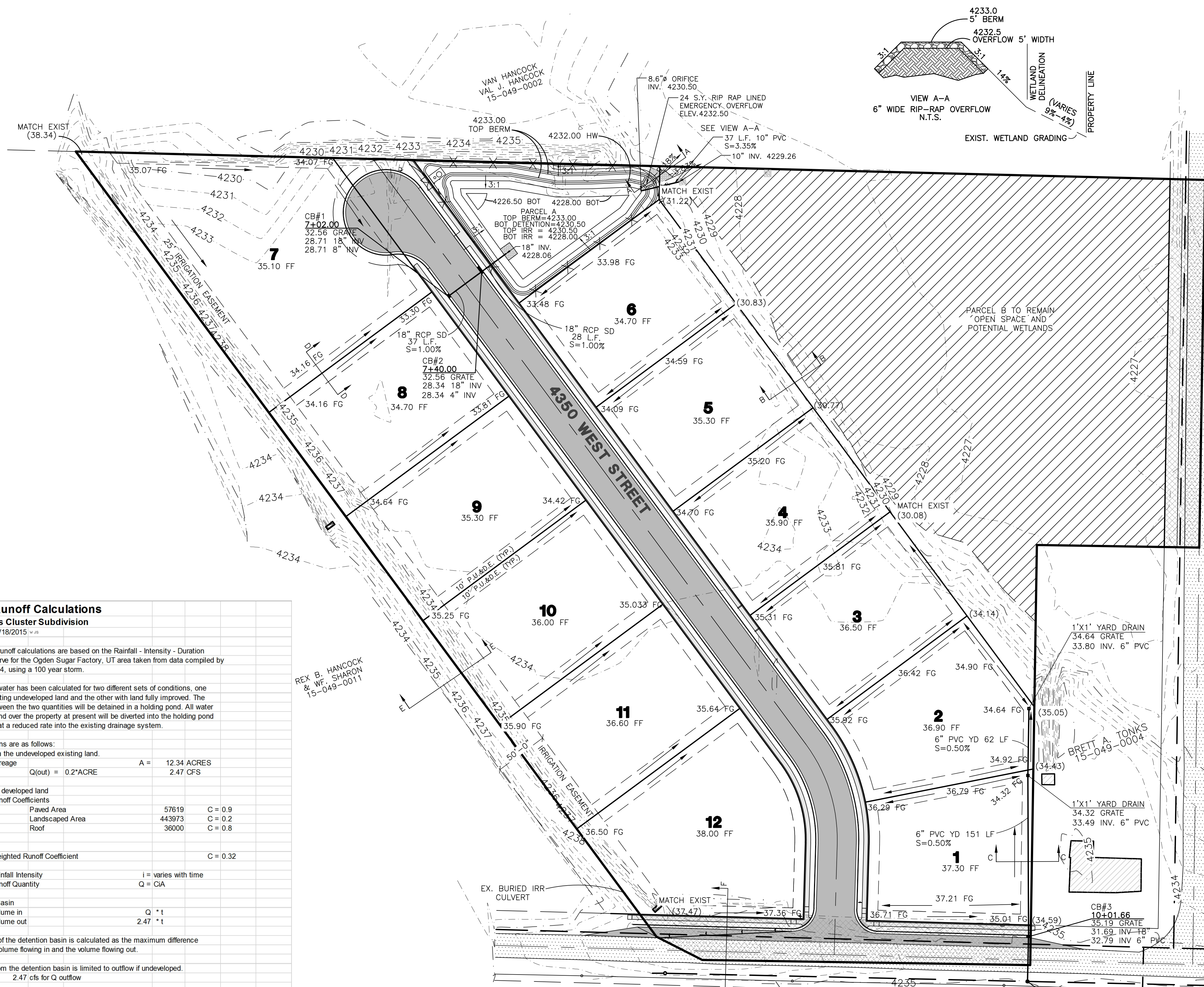

Storm Runoff Calculations
Henry Flats Cluster Subdivision

11/18/2015 v.01
The following runoff calculations are based on the Rainfall - Intensity - Duration Frequency Curve for the Ogden Sugar Factory, UT area taken from data compiled by NOAA Atlas 14, using a 100 year storm.

Runoff storm water has been calculated for two different sets of conditions, one being the existing undeveloped land and the other with land fully improved. The difference between the two quantities will be retained in a holding pond. All water that runs off and over the property at present will be diverted into the holding pond and released at a reduced rate into the existing drainage system.

The calculations are as follows:
1. Runoff from the undeveloped existing land.
Acreage Q(out) = 0.2*ACRE A = 12.34 ACRES 2.47 CFS

2. Runoff from developed land
Runoff Coefficients
Paved Area 57619 C = 0.9
Landscaped Area 443973 C = 0.2
Roof 36000 C = 0.8

Weighted Runoff Coefficient C = 0.32
Rainfall Intensity i = varies with time
Runoff Quantity Q = CIA

3. Detention Basin
Volume in Q * t
Volume out 2.47 * t

The capacity of the detention basin is calculated as the maximum difference between the volume flowing in and the volume flowing out.

The outflow from the detention basin is limited to outflow if undeveloped.
Use 2.47 cfs for Q outflow

The required volume of the detention basin is 15,202 cubic feet

USE A 8.6 INCH DIAMETER ORIFICE AT OUTLET

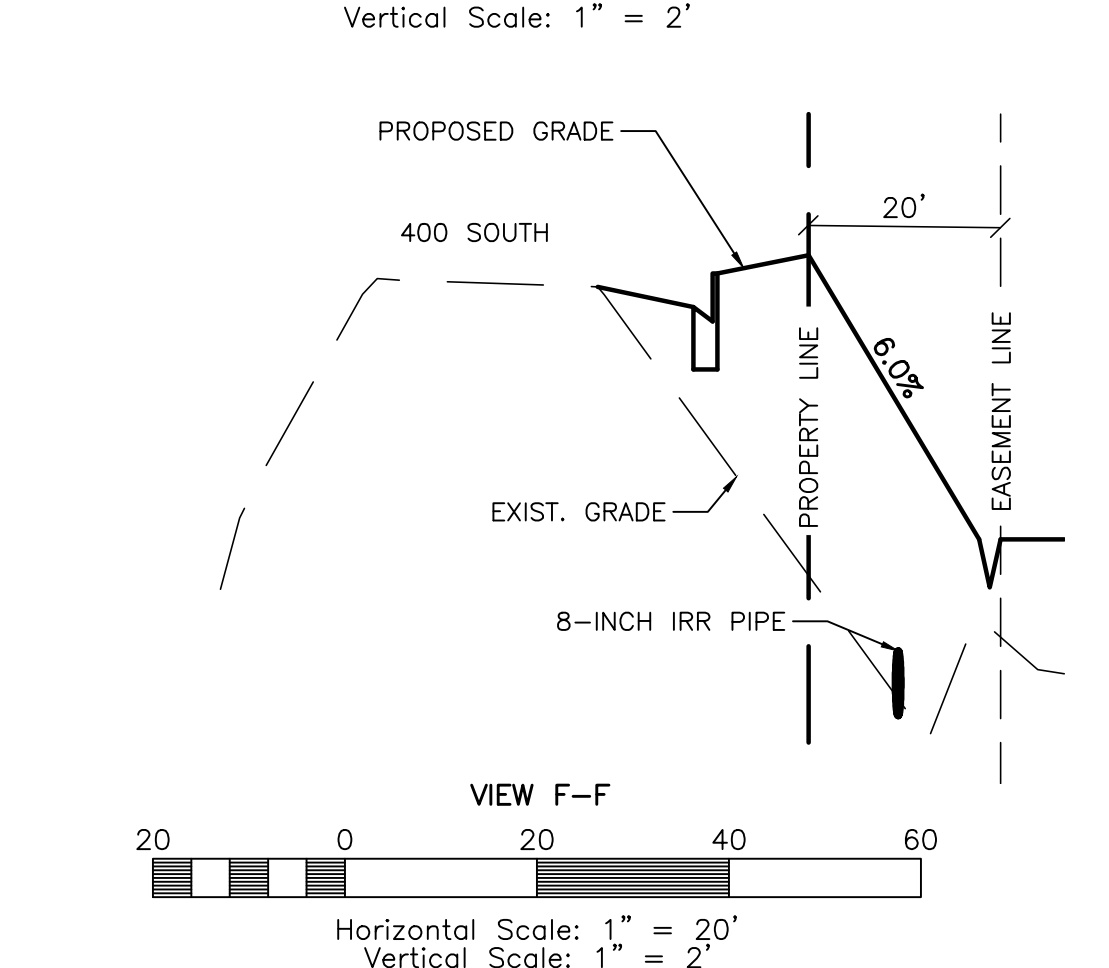
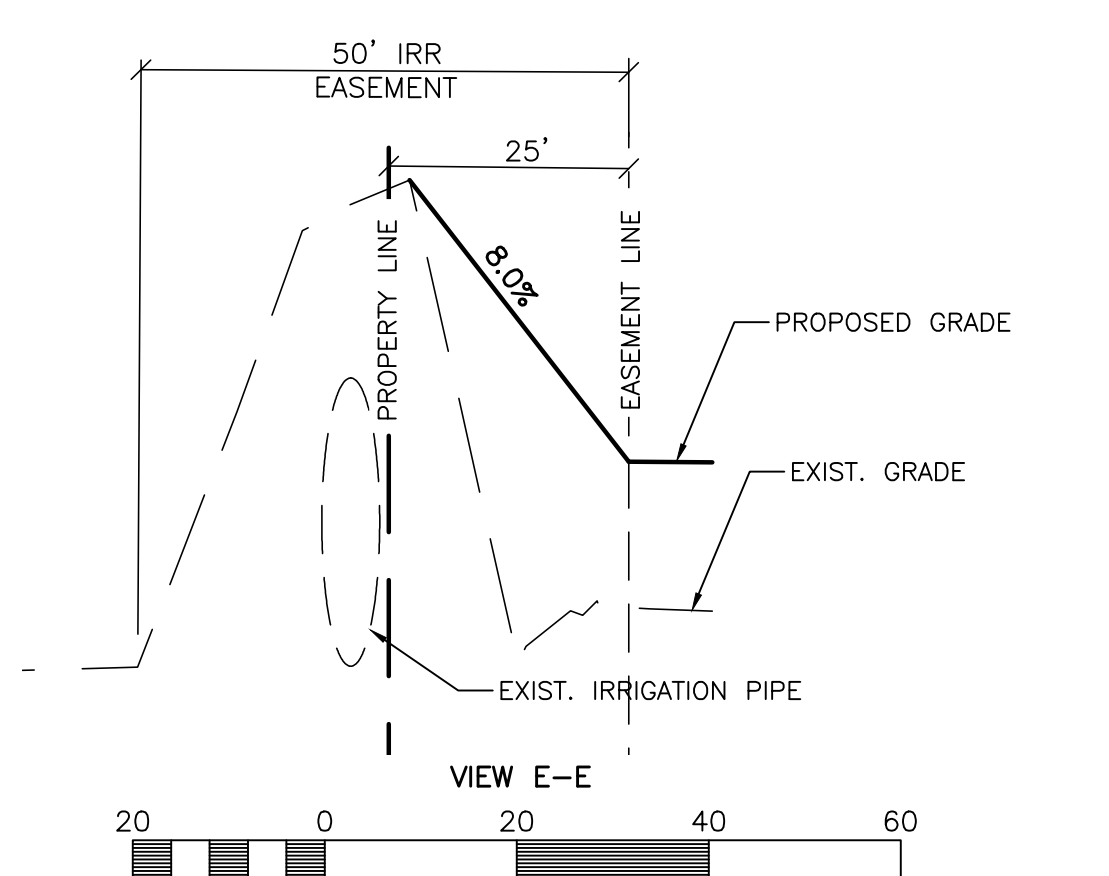
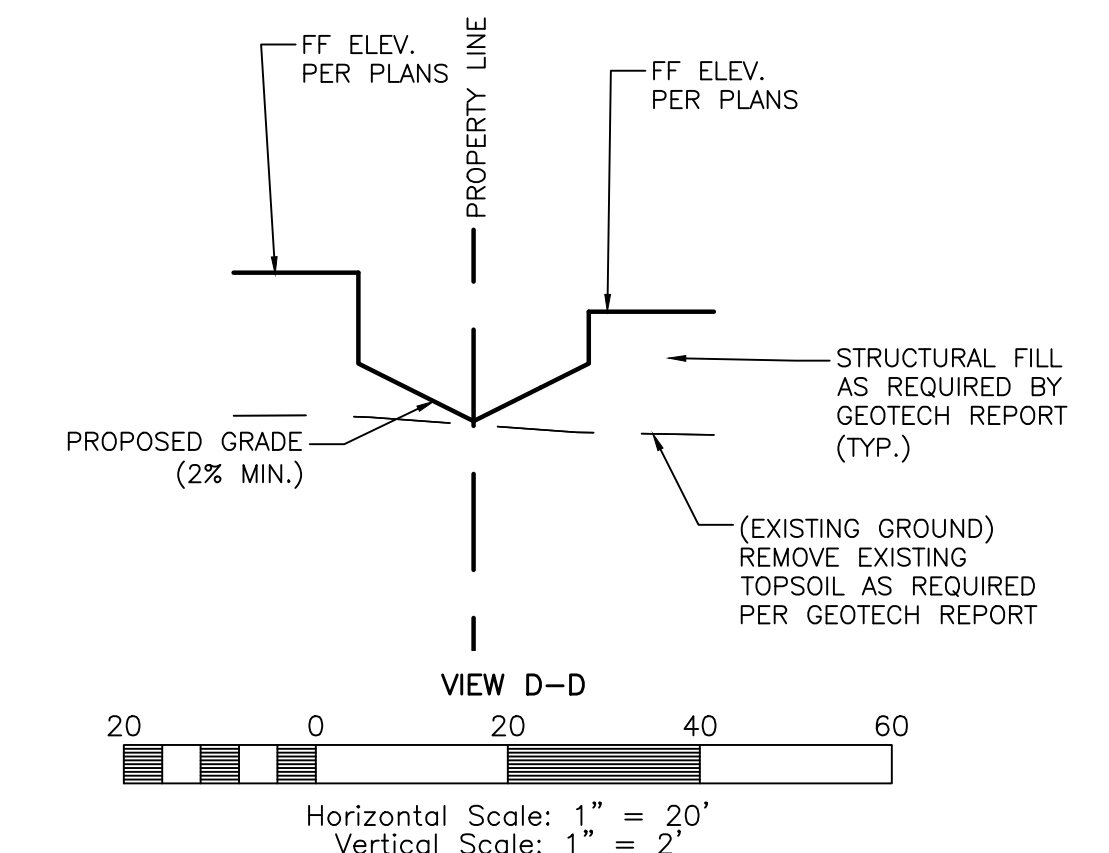
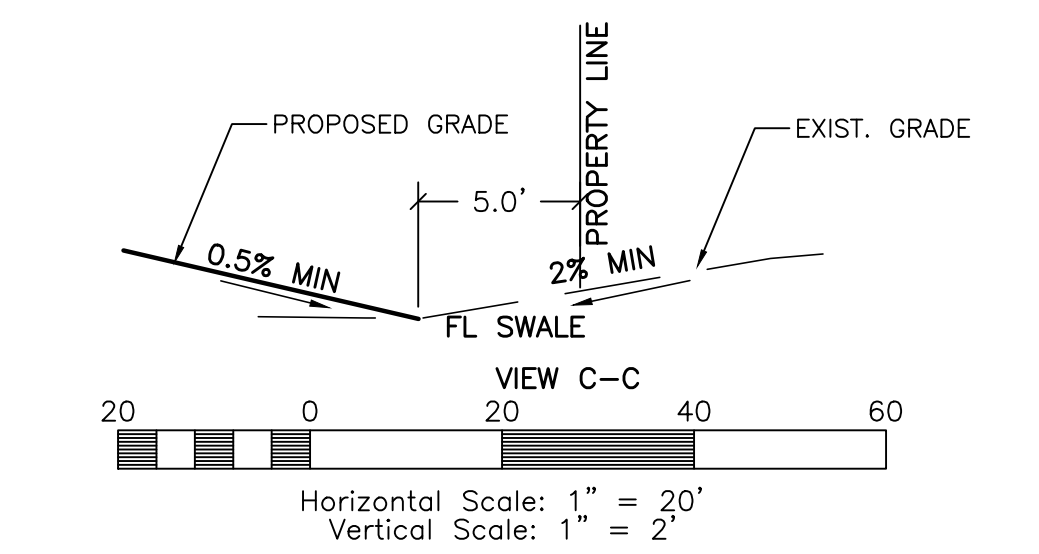
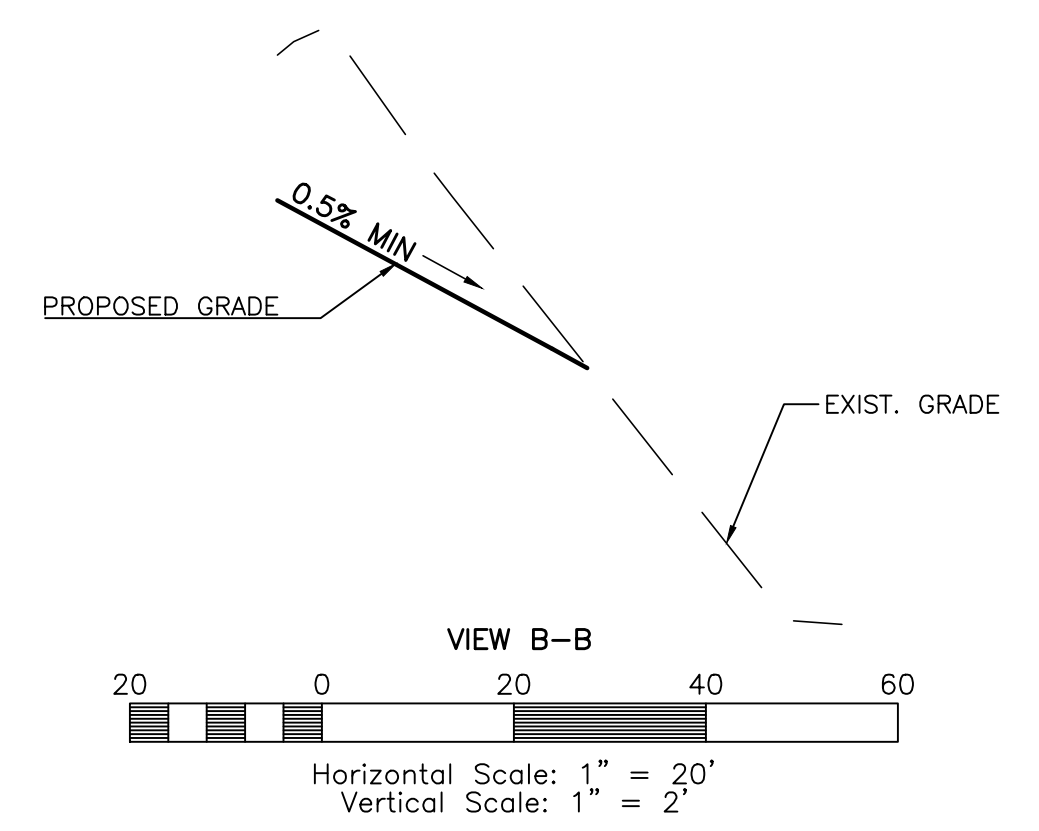
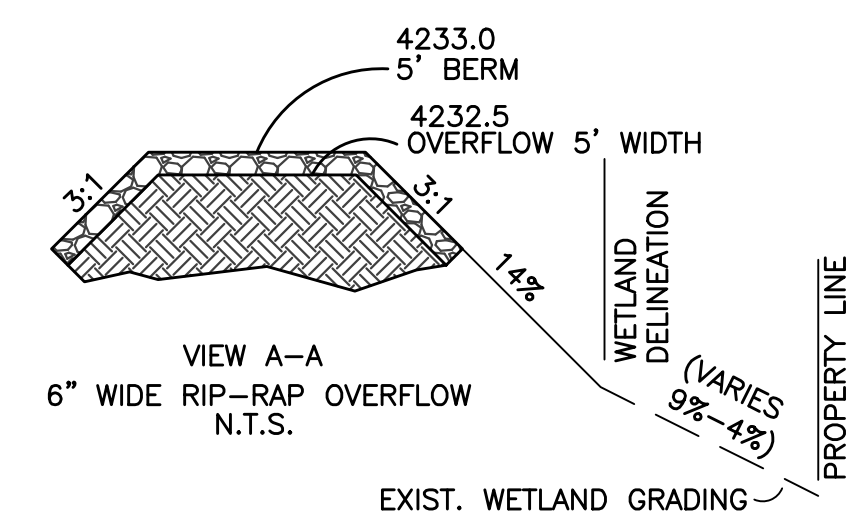

Reeve & Associates, Inc.
5160 SOUTH 1500 WEST, RIVERDALE, UTAH 84405
TEL: (801) 621-2100 FAX: (801) 621-2666 WWW.REEVE-ASSOC.COM
LAND PLANNERS • CIVIL ENGINEERS • LAND SURVEYORS
TRAFFIC ENGINEERS • STRUCTURAL ENGINEERS • LANDSCAPE ARCHITECTS

REVISIONS	DESCRIPTION	DATE

Revised: 09-27-16

Henry Flats Cluster Subdivision
WEBER COUNTY, UTAH

Master Grading Plan

Project Info.
Engineer: J. NATE REEVE
Drafted: C. KINGSLEY
Begin Date: NOVEMBER, 2015
Name: HENRY FLATS CLUSTER SUBDIVISION
Number: 6272-01

Henry Flats Subdivision Phase 1 Storm Water Pollution Prevention Plan Exhibit

WEST WEBER CITY, WEBER COUNTY, UTAH
SEPTEMBER, 2016

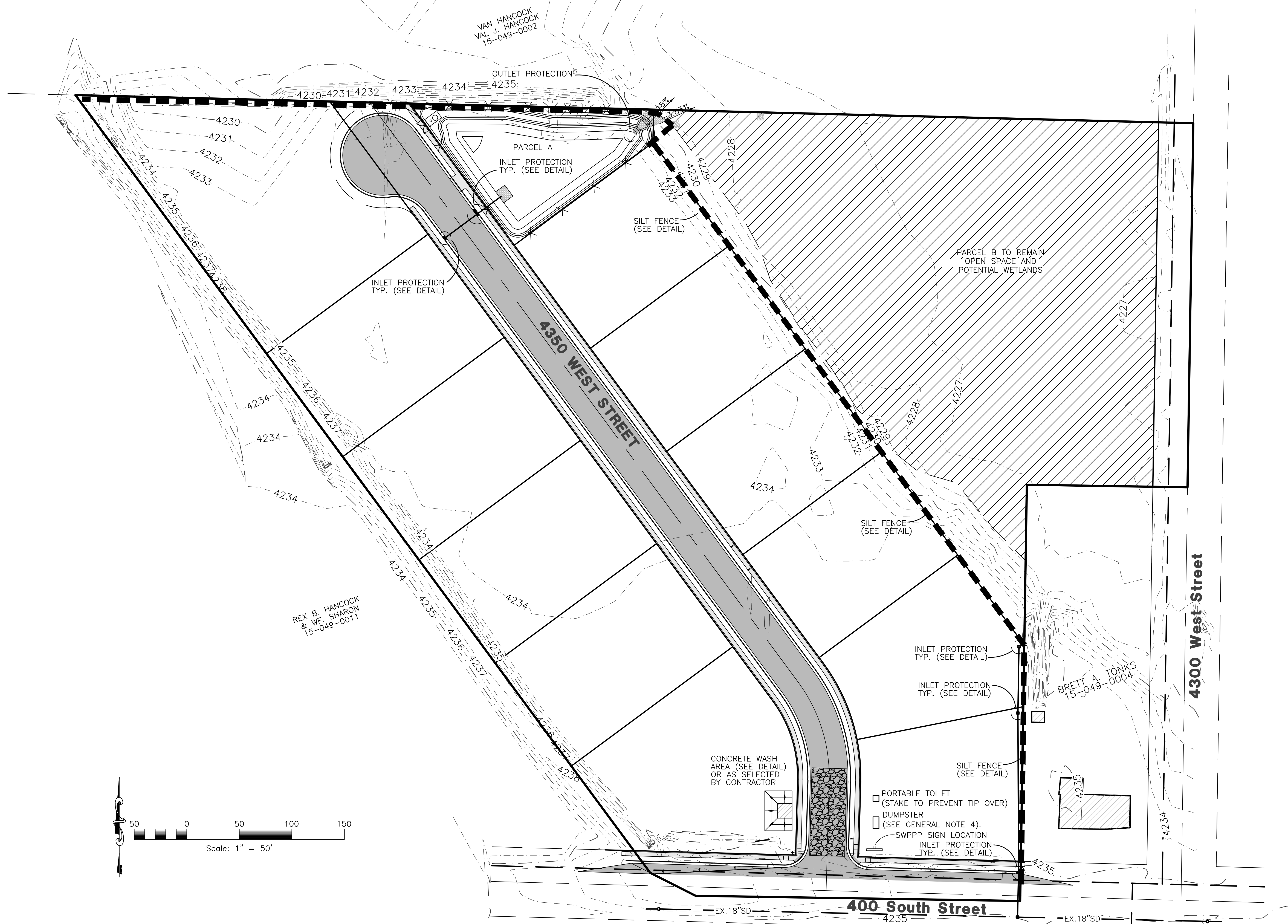

Vicinity Map
NOT TO SCALE

General Notes

1. CONTRACTOR IS REQUIRED TO COMPLETE THE ASSOCIATED PAPERWORK, APPLICATION, AND SUBMITTAL OF THE SWPPP TO THE COUNTY FOR A STORM WATER CONSTRUCTION ACTIVITY PERMIT WITH THE FOLLOW-UP APPLICATION TO THE UTAH STATE DIVISION OF WATER QUALITY (DWQ) FOR OBTAINING AN NOI.
2. THE CURRENT CONSTRUCTION GENERAL PERMIT REQUIRES EROSION PREVENTION, SEDIMENT CONTAINMENT, INLET PROTECTION, GOOD HOUSEKEEPING AND POST CONSTRUCTION STABILIZATION.
3. SILT FENCE TO REMAIN UNTIL LANDSCAPING HAS BEEN INSTALLED FOR LOT & BASIN IMPROVEMENTS.
4. NOTE A COVERED DUMPSTER TO BE EMPTIED WHEN 3/4 FULL.

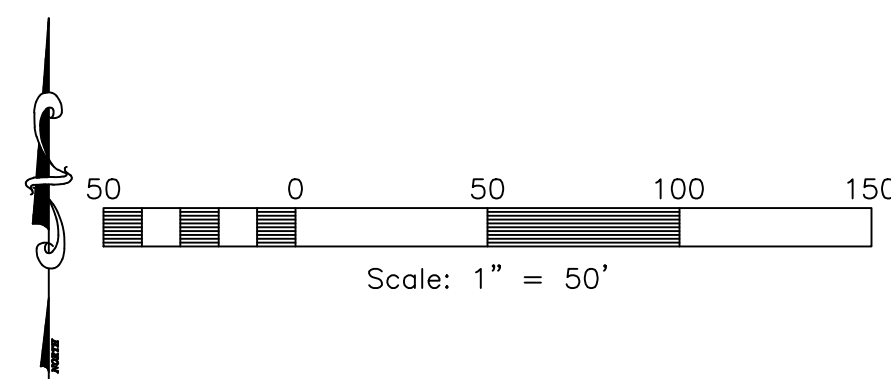

STREETS TO BE SWEEPED WITHIN 1000 FEET OF CONSTRUCTION ENTRANCE DAILY AS NECESSARY.
ALL VEHICLES EXITING SITE TO PROCEED THROUGH CONSTRUCTION ENTRANCE TO REDUCE AMOUNTS OF SEDIMENT TRACKED ONTO ROADWAYS.
50'x20' CONSTRUCTION ENTRANCE W/8" COMPACTED CLEAN GRAVEL CONTRACTOR REQUIRED TO PREVENT TRACK OUT AND BACK UP SUPPORT FOR STREET SWEEPING.

Construction Activity Schedule	
- PROJECT LOCATION.....	WEST WEBER CITY, WEBER COUNTY, UTAH
- PROJECT BEGINNING DATE.....	SEPTEMBER 2016
- BMP'S DEPLOYMENT DATE.....	SEPTEMBER 2016
- STORM WATER MANAGEMENT CONTACT / INSPECTOR.....	TBD
- SPECIFIC CONSTRUCTION SCHEDULE INCLUDING BMP CONSTRUCTION SCHEDULE TO BE INCLUDED WITH SWPPP BY OWNER/DEVELOPER	

Reeve & Associates, Inc.
5160 SOUTH 1500 WEST RIVERDALE, UTAH 84405
TEL: (801) 821-3100 FAX: (801) 621-2666 WWW.REEVE-ASSOC.COM
LAND PLANNERS • CIVIL ENGINEERS • LAND SURVEYORS
TRAFFIC ENGINEERS • STRUCTURAL ENGINEERS • LANDSCAPE ARCHITECTS

REVISIONS	DESCRIPTION

Henry Flats Cluster Subdivision
WEBER COUNTY, UTAH

Storm Water Pollution Prevention Plan Exhibit



Project Info.

Engineer:	J. NATE REEVE
Drafter:	C. KINGSLEY
Begin Date:	NOVEMBER, 2015
Name:	HENRY FLATS CLUSTER SUBDIVISION
Number:	6272-01

Sheet	12
8	Sheets

Notes:

- Describe all BMP's to protect storm water inlets:
All storm water inlets to be protected by straw wattle barriers, or gravel bags (see detail).
- Describe BMP's to eliminate/reduce contamination of storm water from:
 - Equipment / building / concrete wash areas:
To be performed in designated areas only and surrounded with silt fence barriers.
 - Soil contaminated by soil amendments:
If any contaminants are found or generated, contact environmental engineer and contacts listed.
 - Areas of contaminated soil:
If any contaminants are found or generated, contact environmental engineer and contacts listed.
 - Fueling area:
To be performed in designated areas only and surrounded with silt fence.
 - Vehicle maintenance areas:
To be performed in designated areas only and surrounded with silt fence.
 - Vehicle parking areas:
To be performed in designated areas only and surrounded with silt fence.
 - Equipment storage areas:
To be performed in designated areas only and surrounded with silt fence.
 - Materials storage areas:
To be performed in designated areas only and surrounded with silt fence.
 - Waste containment areas:
To be performed in designated areas only and surrounded with silt fence. All dumpsters or trash containers shall be covered and no fluids shall be placed therein.
 - Service areas:
To be performed in designated areas only and surrounded with silt fence.
- BMP's for wind erosion:
Stockpiles and site as needed to be watered regularly to eliminate / control wind erosion
- Construction Vehicles and Equipment:
 - Maintenance
 - Maintain all construction equipment to prevent oil or other fluid leaks.
 - Keep vehicles and equipment clean, prevent excessive build-up of oil and grease.
 - Regularly inspect on-site vehicles and equipment for leaks, and repair immediately.
 - Check incoming vehicles and equipment (including delivery trucks, and employee and subcontractor vehicles) for leaking oil and fluids. Do not allow leaking vehicles or equipment on-site.
 - Segregate and recycle wastes, such as greases, used oil or oil filters, antifreeze, cleaning solutions, automotive batteries, hydraulic, and transmission fluids.
 - No liquid waste shall be poured out onto the ground or to any drain but disposed of in a proper legal manner.
 - Fueling
 - If fueling must occur on-site, use designated areas away from drainage.
 - Locate on-site fuel storage tanks within a bermed area designed to hold the tank volume.
 - Cover retention area with an impervious material and install in a manner to ensure that any spills will be contained in the retention area. To catch spills or leaks when removing or changing fluids.
 - Use drip pans for any oil or fluid changes.
 - Remove and dispose of any contaminated soils resulting from fuel spillage in the legal and proper manner.
 - Washing
 - Use as little water as possible to avoid installing erosion and sediment controls for the wash area.
 - If washing must occur on-site, use designated, bermed wash areas to prevent waste water discharge into storm water, creeks, rivers, and other water bodies.
 - Do not permit steam cleaning on-site.
 - No discharge of wash water containing soaps, detergents or solvents shall be allowed onsite.
- Spill Prevention and Control
 - Minor Spills:
Minor spills are those which are likely to be controlled by on-site personnel. After contacting local emergency response agencies, the following actions should occur upon discovery of a minor spill:
 - Contain the spread of the spill.
 - If the spill occurs on paved or impermeable surfaces, clean up using "dry" methods (i.e. absorbent materials, cat litter, and / or rags).
 - If the spill occurs in dirt areas, immediately contain the spill by constructing an earth dike. Dig up & properly dispose of contaminated soil.
 - If the spill occurs during rain, cover the impacted area to avoid runoff.
 - Record all steps taken to report and contain spill.
 - Major Spills:
On-site personnel should not attempt to control major spills until the appropriate and qualified emergency response staff have arrived at the site. For spills of federal reportable quantities, also notify the National Response Center at (800) 424-9802. A written report should be sent to all notified authorities. Failure to report major spills can result in significant fines and penalties.
- Post Roadway / Utility Construction
 - Maintain good housekeeping practices.
 - Enclose or cover building material storage areas.
 - Properly store materials such as paints and solvents.
 - Store dry and wet materials under cover, away from drainage areas.
 - Avoid mixing excess amounts of fresh concrete or cement on-site.
 - Perform washout of concrete trucks offsite or in designated areas only. Washouts must be emptied when reaching 75% of being filled.
 - Do not wash out concrete trucks into storm drains, open ditches, streets or streams.
 - Do not place material or debris into streams, gutters or catch basins that stop or reduce the flow of runoff water.
 - All public streets and storm drain facilities shall be maintained free of building materials, mud and debris caused by grading or construction operations. Roads will be swept within 1000' of construction entrance daily, if necessary.
 - Install straw wattle around all inlets contained within the development and all others that receive runoff from the development.
- Storm Water Pollution Prevention Plan (SWPPP) Notes
 - The contractor will designate an emergency contact that can be reached 24 hours a day 7 days a week.
 - A stand-by crew for emergency work shall be available at all times during potential rain or snow runoff events. Necessary materials shall be available on site and stockpiled at convenient locations to facilitate rapid construction of emergency devices when rain or runoff is eminent.
 - Erosion control devices shown on the plans and approved for the project may not be removed without approval of the engineer of record. If devices are removed, no work may continue that have the potential of erosion without consulting the engineer of record. If deemed necessary erosion control shall be reestablished before the work recommences.
 - Graded areas adjacent to fill slopes located at the site perimeter must drain away from the top of the slope at the conclusion of each working day. This should be confirmed by survey or other means acceptable to the engineer of record.
 - All silt and debris shall be removed from all devices within 24 hours after each rain or runoff event.
 - Except as otherwise approved by the inspector, all removable protective devices shown shall be in place at the end of each working day and through weekends until removal of the system is approved.
 - Concrete washout area to be emptied when 3/4 full.
 - All loose soil and debris, which may create a potential hazard to offsite property, shall be removed from the site as directed by the Engineer of record using a SWPPP amendment.
 - The placement of additional devices to reduce erosion damage within the site is left to the discretion of the Engineer of record.
 - Desilting basins may not be removed or made inoperable without the approval of the engineer of record and the governing agency.
 - Erosion control devices will be modified as need as the project progresses, and plans of these changes submitted for approval by the engineer of record and the governing agency using a SWPPP amendment.
- Conduct a minimum of one inspection of the erosion and sediment controls every two weeks. Maintain documentation on site.
 - Part III.D.4 of general permit UTR300000 identifies the minimum inspection requirements.
 - Part II.D.4.C identifies the minimum inspection report requirements.
 - failure to complete and/or document storm water inspections is a violation of part III.D.4 of Utah General Permit UTR 300000.
- Portable toilets shall be set back a minimum of 10 feet from the back of any curb line and/or 10 feet from any storm drain inlet. All portable toilets shall be properly staked to prevent tip over or spillage.

50'x36' CONSTRUCTION ENTRANCE

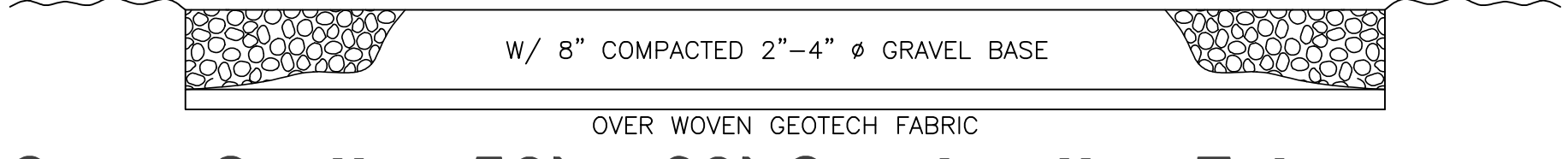

Cross Section 50' x 20' Construction Entrance

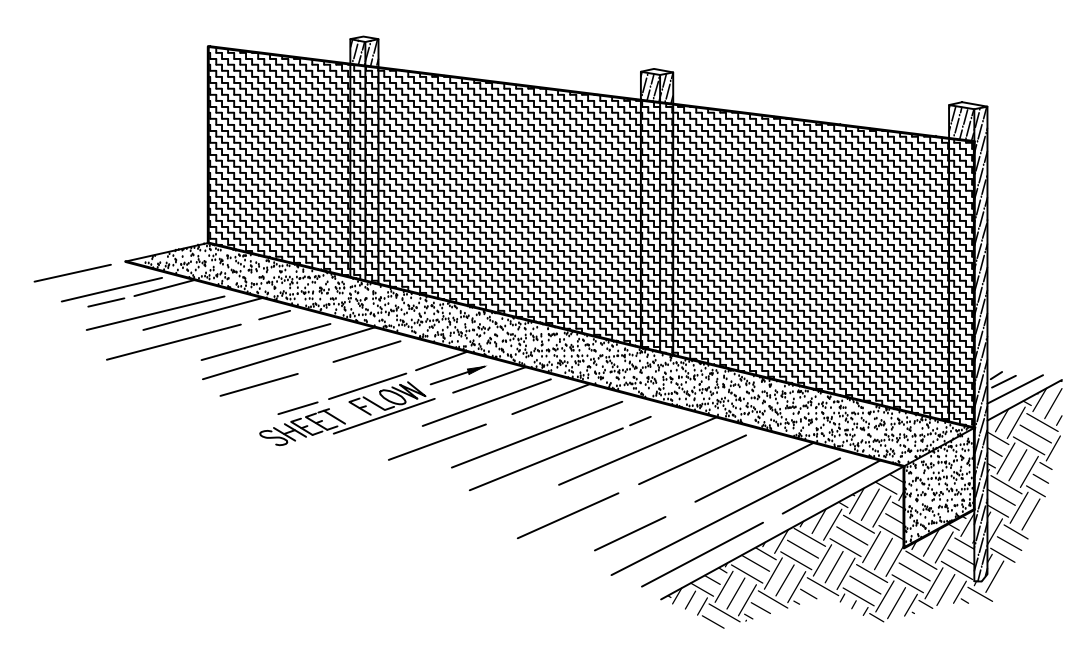

Perspective View

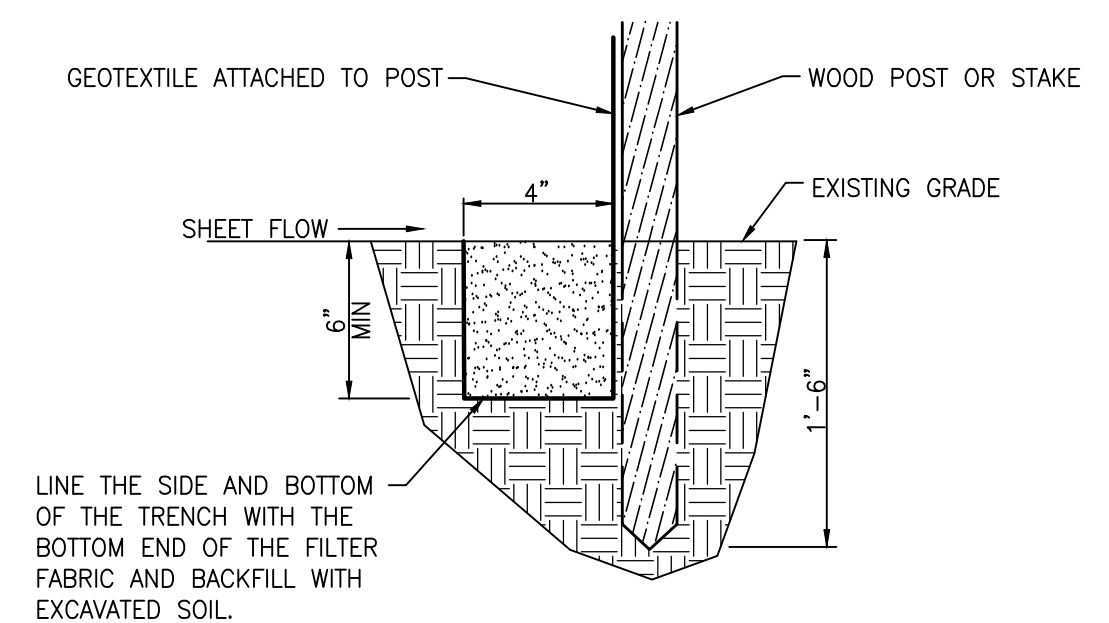

Section

INSTALLATION

The silt fence should be installed prior to major soil disturbances in the drainage area. The fence should be placed across the slope along a line of uniform elevation wherever flow of sediment is anticipated. Table 1 shows generally-recommended maximum slope lengths (slope spacing between fences) at various site grades for most silt fence applications.

TABLE 1: Recommended Maximum Slope Lengths for Silt Fence (Richardson & Middlebrooks, 1991)	
Slope Steepness (%)	Max. Slope Length (m (ft))
<2%	30.5m (100ft)
2-5%	22.9m (75ft)
5-10%	15.2m (50ft)
10-20%	7.6m (25ft)
>20%	4.5m (15ft)

PREFABRICATED SILT FENCE ROLLS

- Excavate a minimum 15.2cm x 15.2cm (6"x6") trench at the desired location.
- Unroll the silt fence, positioning the post against the downstream wall of the trench.
- Adjacent rolls of silt fence should be joined by nesting the end post of one fence into the other. Before nesting the end posts, rotate each post until the geotextile is wrapped completely around the post, then abut the end posts to create a tight seal as shown in Figure 1.
- Drive posts into the ground until the required fence height and/or anchorage depth is obtained.
- Bury the loose geotextile at the bottom of the fence in the upstream trench and backfill with natural soil, tamping the backfill to provide good compaction and anchorage. Figure 2 illustrates a typical silt fence installation and anchor trench placement.

INSPECTION

- Inspect the silt fence daily during periods of rainfall, immediately after significant rainfall event and weekly during periods of no rainfall. Make any repairs immediately.
- When sediment deposits behind the silt fence are one-third of the fence height, remove and properly dispose of the silt accumulations. Avoid damage to the fabric during cleanup.

REMOVAL

- Silt fence should not be removed until construction ceases and the upslope area has been properly stabilized and/or revegetated.

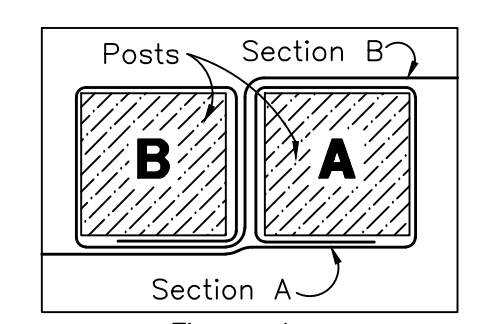

Figure 1:
Top View of Roll-to-Roll Connection

FIELD ASSEMBLY:

- Excavate a minimum 15.2cm x 15.2cm (6"x6") trench at the desired location.
- Drive wooden posts, or steel posts with fastening projections, against the downstream wall of the trench. Maximum post spacing should be 2.4-3.0m (8-10ft). Post spacing should generally be less than three (3) times the height of the fence.

Silt Fence Detail

SCALE: NONE

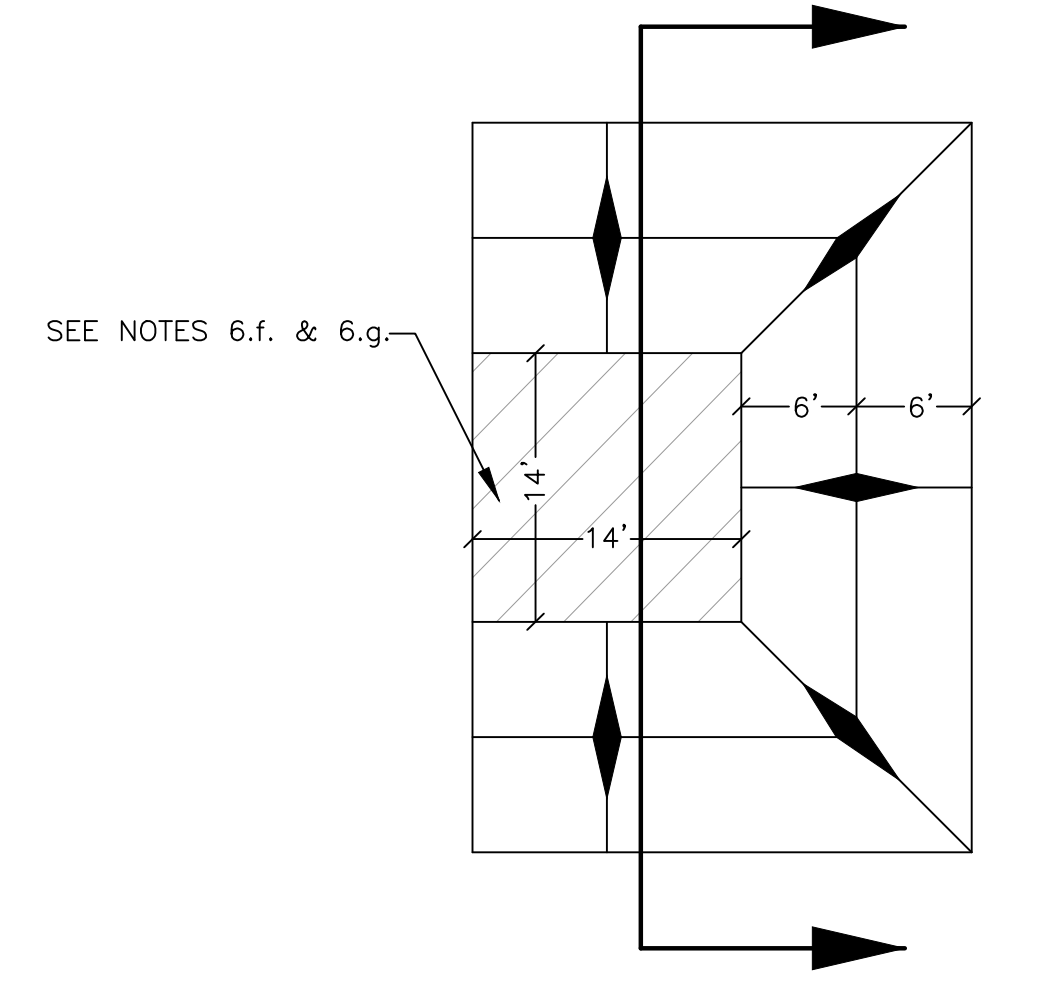
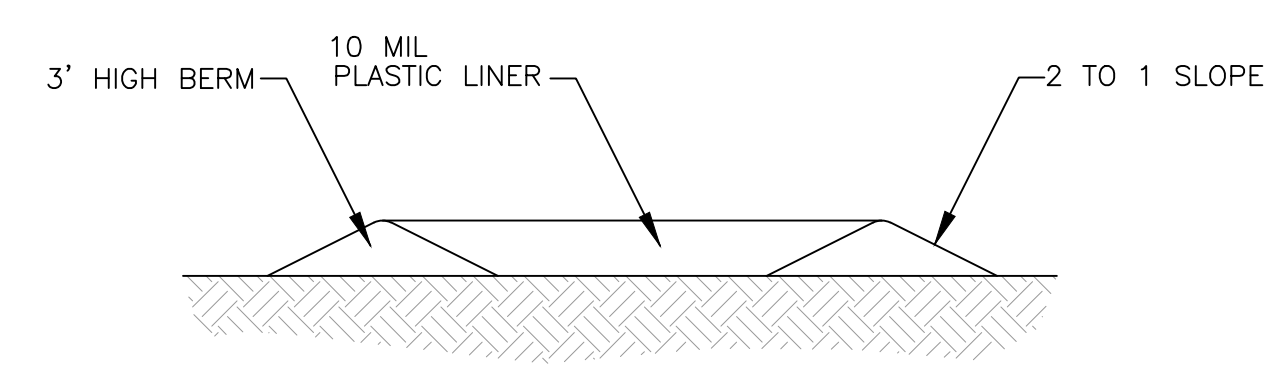

Concrete Washout Area w/ 10 mil Plastic Liner

SCALE: NONE

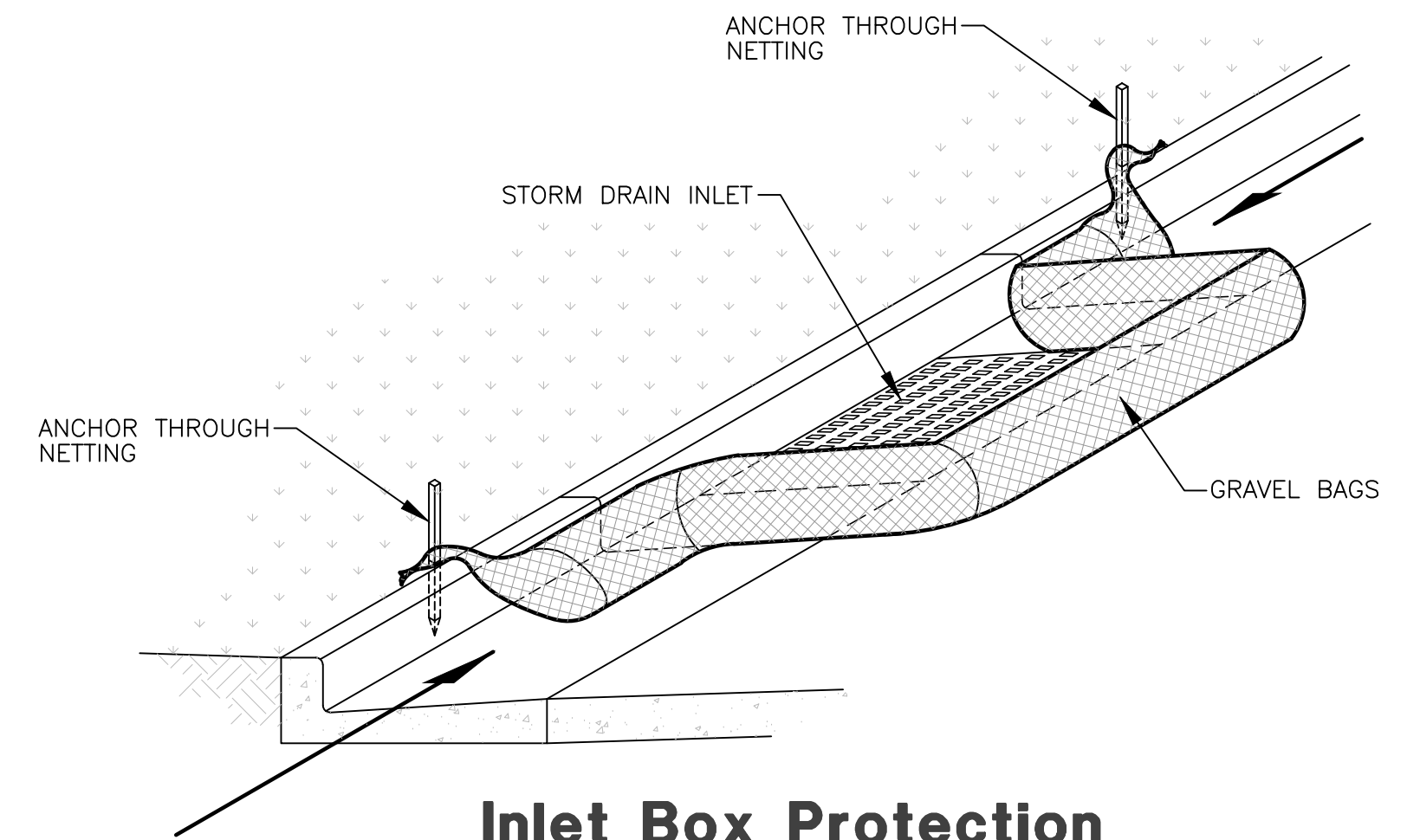

Inlet Box Protection

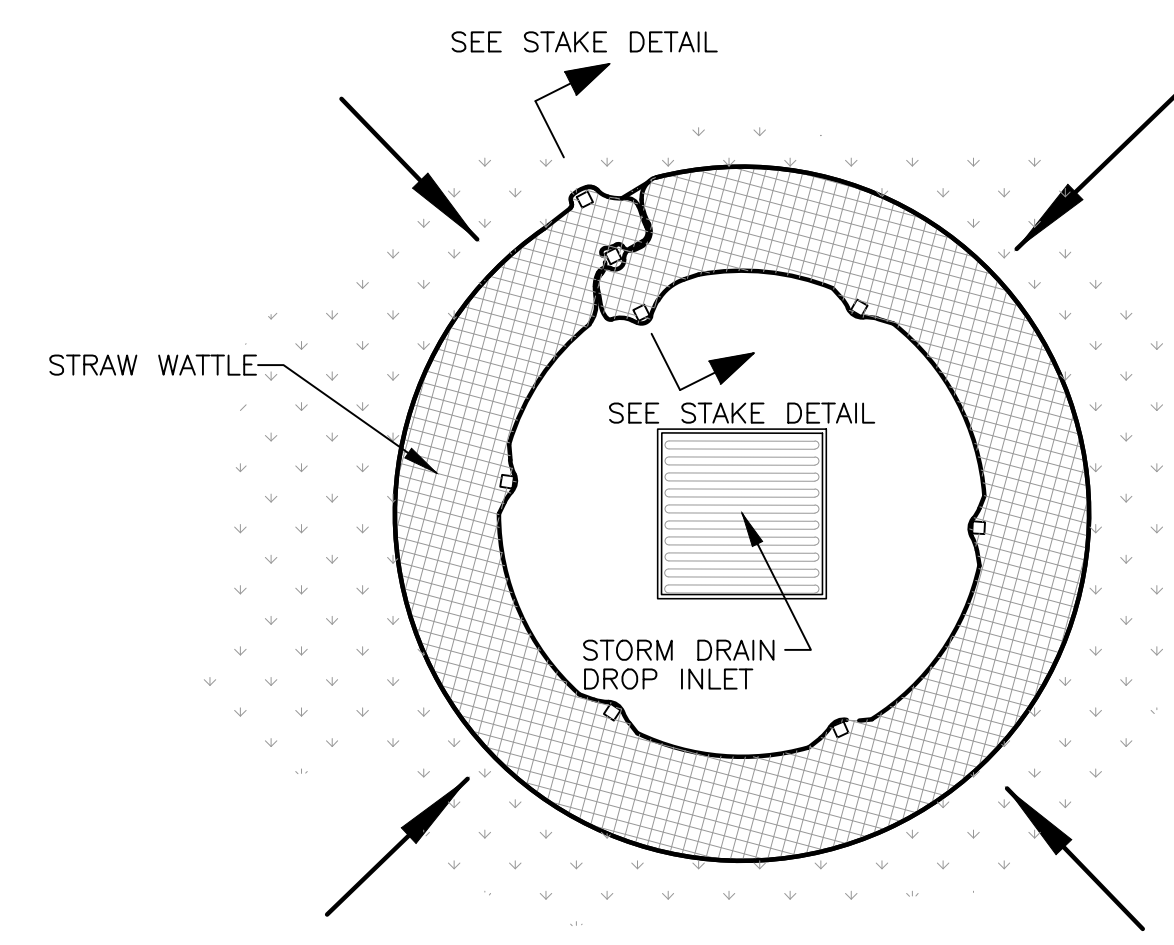

Plan View

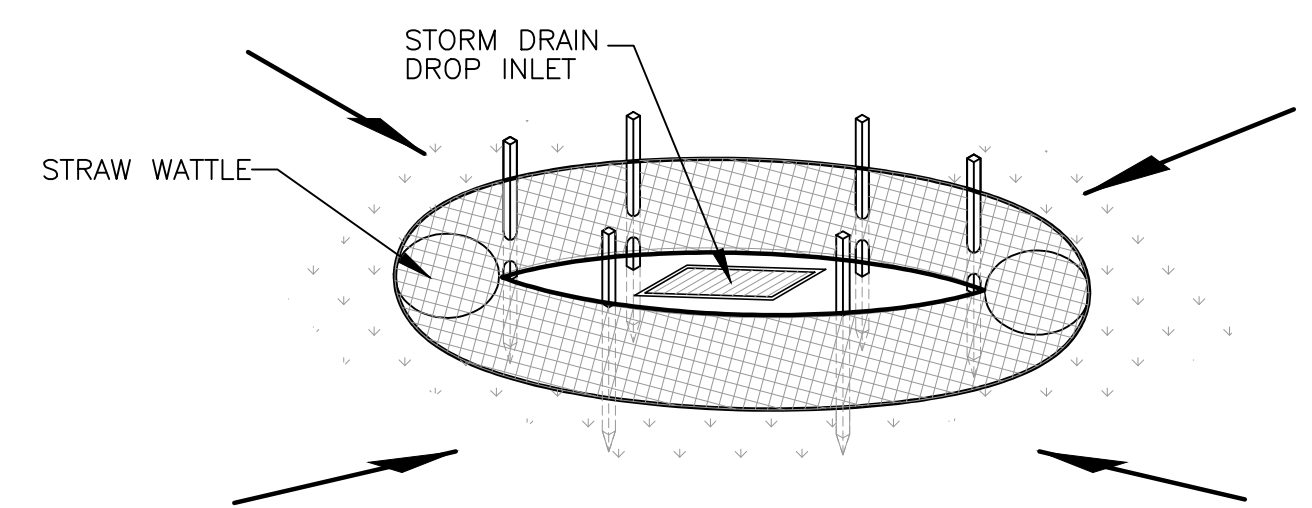

Drop Inlet Protection

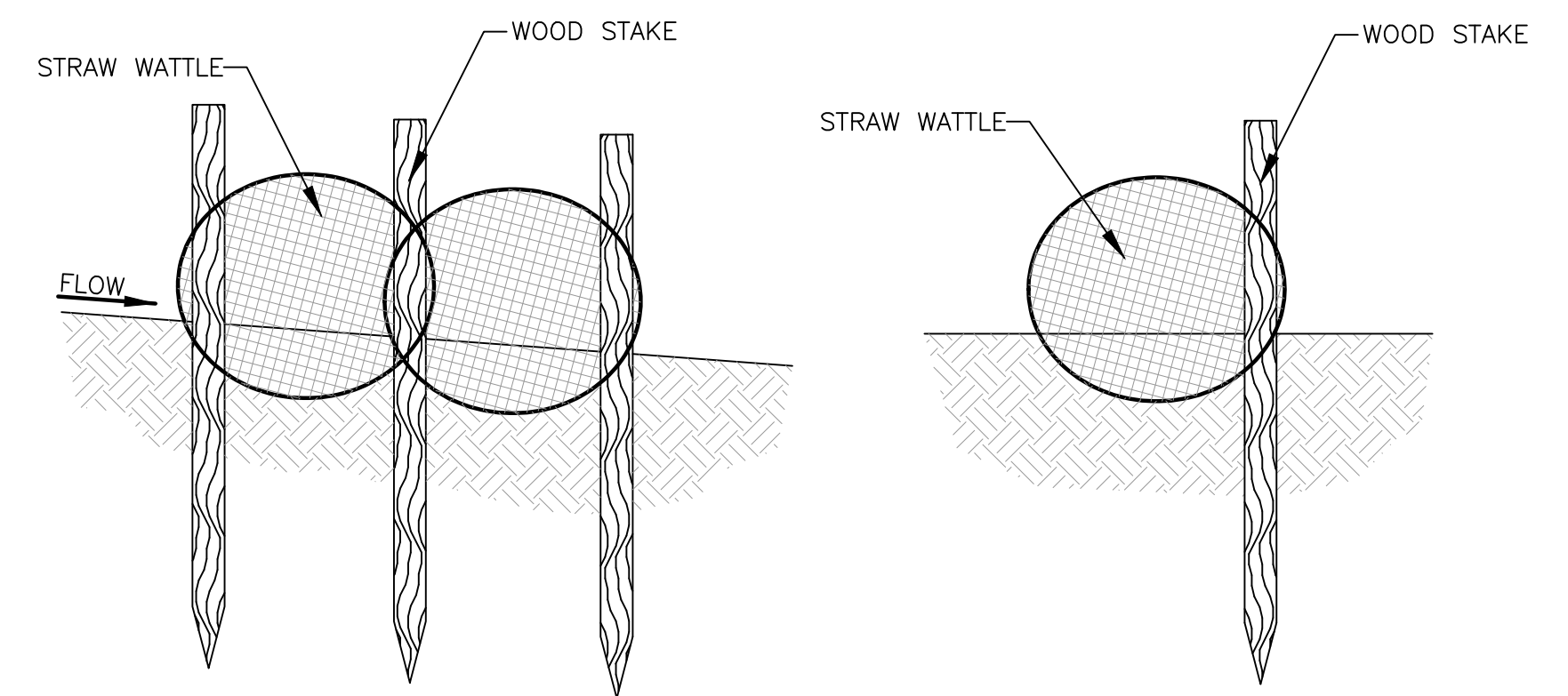

Stake Detail

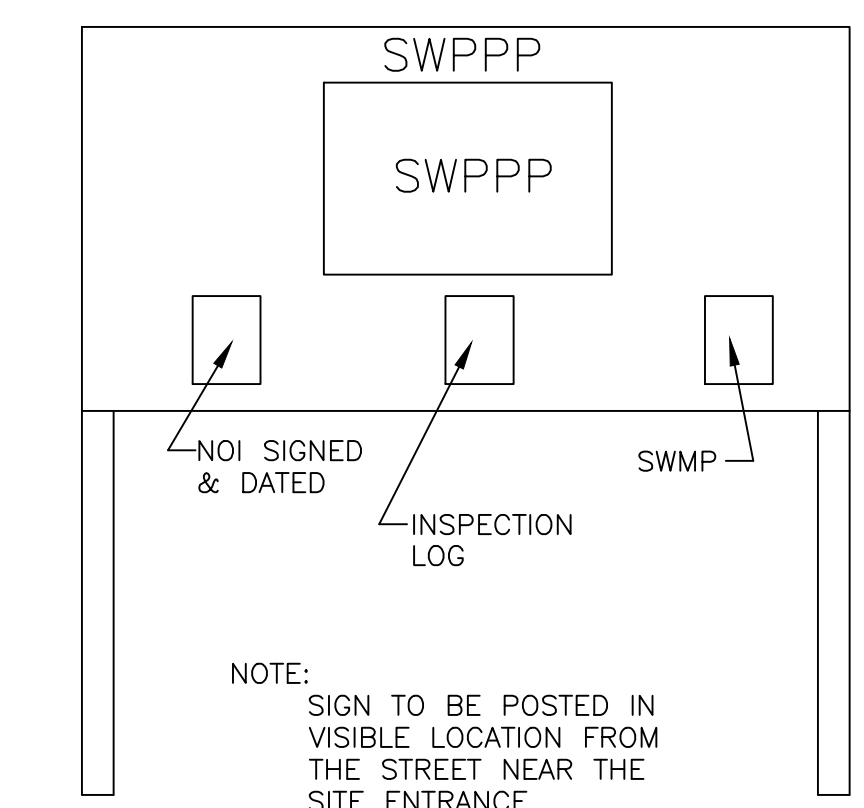

Sample SWPPP Board (4'x8' Sheet of Plywood)

SCALE: NONE

Reeve & Associates, Inc.
5160 SOUTH 1500 WEST, RIVERDALE, UTAH 84405
TEL: (801) 621-2100 FAX: (801) 621-2666 WWW.REEVE-ASSOCIATES.COM
LAND PLANNERS • CIVIL ENGINEERS • LAND SURVEYORS
PRACTICE ENGINEERS • STRUCTURAL ENGINEERS • LANDSCAPE ARCHITECTS

REVISIONS	DESCRIPTION	DATE

Henry Flats Cluster Subdivision
WEBER COUNTY, UTAH
Storm Water Pollution Prevention Plan Details

REGISTERED PROFESSIONAL ENGINEER
375328
J. NATE REEVE
9-27-16
STATE OF UTAH

Project Info.
Engineer: J. NATE REEVE
Drafted: C. KINGSLEY
Begin Date: NOVEMBER, 2015
Name: HENRY FLATS CLUSTER SUBDIVISION
Number: 6272-01

Sheet **12**
9 Sheets

Revised: 09-27-16

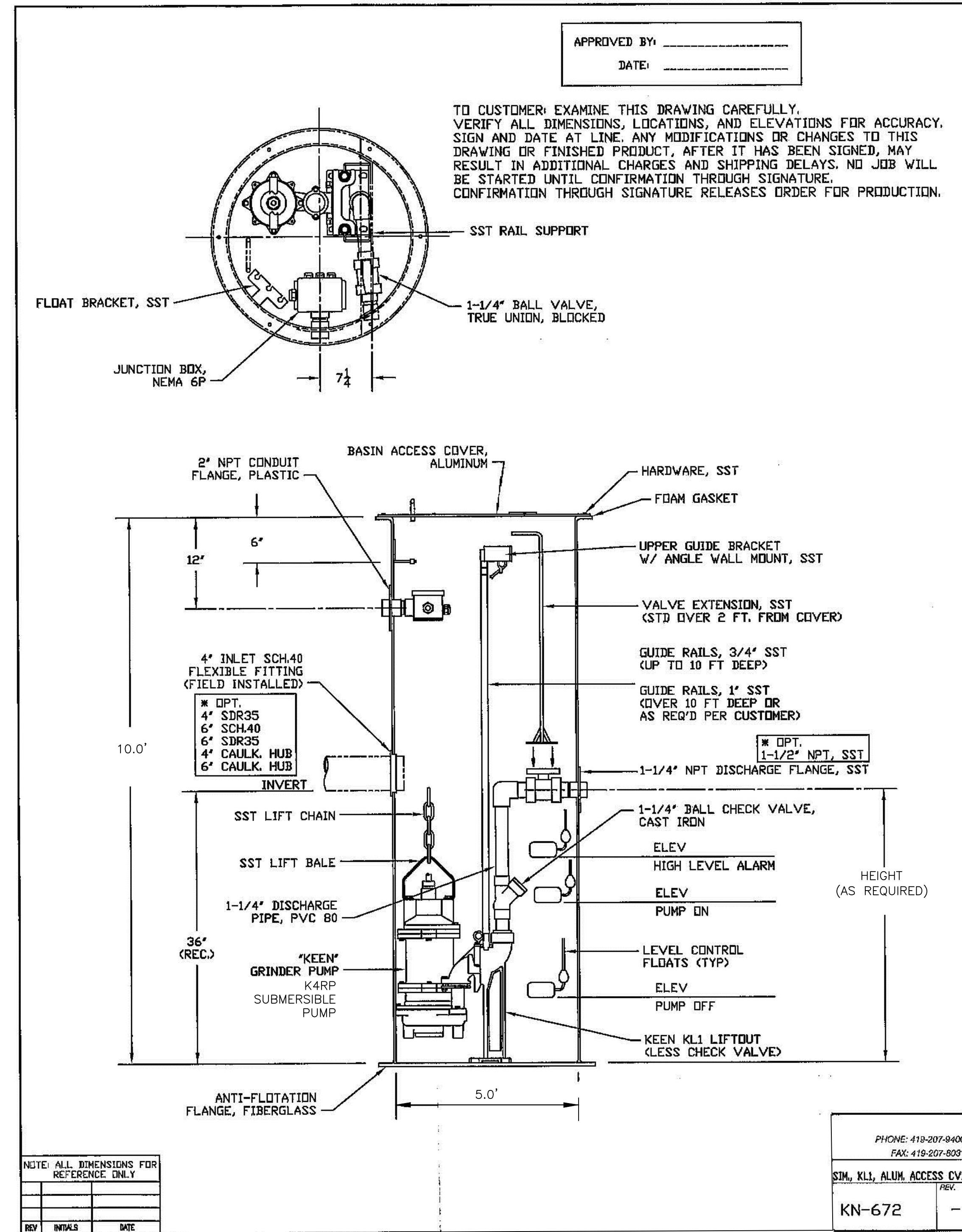

PUMP DETAIL
 SCALE: NONE

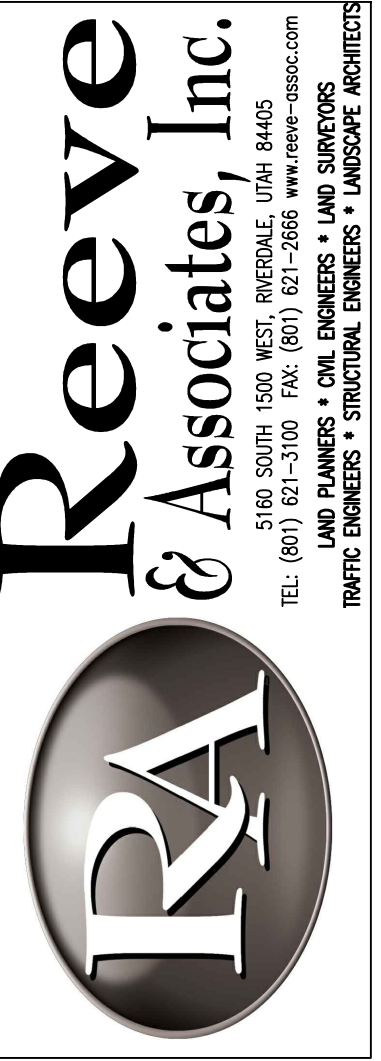

REVISIONS	DESCRIPTION

Henry Flats Cluster Subdivision
 WEBER COUNTY, UTAH
PUMP DETAIL



Project Info.
 Engineer: J. NATE REEVE
 Drafter: C. KINGSLEY
 Begin Date: NOVEMBER, 2015
 Name: HENRY FLATS CLUSTER SUBDIVISION
 Number: 6272-01

