



**General Notes:**

- ALL CONSTRUCTION MUST STRICTLY FOLLOW THE STANDARDS AND SPECIFICATIONS SET FORTH BY: GOVERNING UTILITY MUNICIPALITY, GOVERNING CITY OR COUNTY (IF UN-INCORPORATED), INDIVIDUAL PRODUCT MANUFACTURERS, AMERICAN PUBLIC WORKS ASSOCIATION (APWA), AND THE DESIGN ENGINEER. THE ORDER LISTED ABOVE IS ARRANGED BY SENIORITY. IF A CONSTRUCTION PRACTICE IS NOT SPECIFIED BY ANY OF THE LISTED SOURCES, CONTRACTOR MUST CONTACT THE DESIGN ENGINEER FOR DIRECTION.
- CONTRACTOR TO STRICTLY FOLLOW GEOTECHNICAL RECOMMENDATIONS FOR THIS PROJECT. ALL GRADING INCLUDING BUT NOT LIMITED TO CUT, FILL, COMPACTION, ASPHALT SECTION, SUBBASE, TRENCH EXCAVATION/BACKFILL, SITE GRUBBING, RETAINING WALLS AND FOOTINGS MUST BE COORDINATED DIRECTLY WITH THE PROJECT PRIOR TO BIDDING TO CURRENT GOVERNING AGENCIES TRANSPORTATION ENGINEER'S MANUAL AND MANUAL OF UNIFORM TRAFFIC CONTROL DEVICES.
- ANY AREA OUTSIDE THE LIMIT OF WORK THAT IS DISTURBED SHALL BE RESTORED TO ITS ORIGINAL CONDITION AT NO COST TO OWNER. CONSULT ALL OF THE DRAWINGS AND SPECIFICATIONS FOR COORDINATION REQUIREMENTS BEFORE COMMENCING CONSTRUCTION.
- AT ALL LOCATIONS WHERE EXISTING PAVEMENT ABUTS NEW CONSTRUCTION, THE EDGE OF THE EXISTING PAVEMENT SHALL BE SAWCUT TO A CLEAN, SMOOTH EDGE.
- ALL CONSTRUCTION MATERIALS SHALL BE IN ACCORDANCE WITH THE MOST RECENT, ADOPTED EDITION OF ADA ACCESSIBILITY GUIDELINES. PRIOR TO STARTING CONSTRUCTION, THE CONTRACTOR SHALL BE RESPONSIBLE FOR MAKING SURE THAT ALL REQUIRED PERMITS AND APPROVALS HAVE BEEN OBTAINED. NO CONSTRUCTION OR FABRICATION SHALL BEGIN UNTIL THE CONTRACTOR HAS RECEIVED THOROUGHLY REVIEWED PLANS AND OTHER DOCUMENTS APPROVED BY ALL PERTINENT AUTHORITIES.
- CONTRACTOR IS RESPONSIBLE FOR SCHEDULING AND NOTIFYING ENGINEER OR INSPECTING AUTHORITY 48 HOURS IN ADVANCE OF COVERING UP ANY PHASE OF CONSTRUCTION REQUIRING OBSERVATION.
- ANY WORK IN THE PUBLIC RIGHT-OF-WAY WILL REQUIRE PERMITS FROM THE APPROPRIATE CITY, COUNTY OR STATE AGENCY CONTROLLING THE ROAD, INCLUDING OBTAINING REQUIRED INSPECTIONS.
- ALL DIMENSIONS, GRADES & UTILITY DESIGNS SHOWN ON THE PLANS SHALL BE VERIFIED BY THE CONTRACTOR PRIOR TO CONSTRUCTION. CONTRACTOR SHALL NOTIFY ENGINEER OF ANY DISCREPANCIES PRIOR TO PROCEEDING WITH CONSTRUCTION FOR NECESSARY PLAN OR GRADE CHANGES.
- CONTRACTOR MUST VERIFY ALL EXISTING CONDITIONS BEFORE BIDDING AND BRING UP ANY QUESTIONS BEFOREHAND.
- SITE GRADING SHALL BE PERFORMED IN ACCORDANCE WITH THESE PLANS AND SPECIFICATIONS AND THE RECOMMENDATIONS SET FORTH BY THE GEOTECHNICAL ENGINEER.
- CATCH SLOPES SHALL BE GRADED AS SPECIFIED ON GRADING PLANS.
- CONTRACTOR SHALL BE RESPONSIBLE FOR ALL FLAGGING, CAUTION SIGNS, LIGHTS, BARRICADES, FLAGMEN, AND ALL OTHER DEVICES NECESSARY FOR PUBLIC SAFETY.
- CONTRACTOR SHALL, AT THE TIME OF BIDDING AND THROUGHOUT THE PERIOD OF THE CONTRACT, BE LICENSED IN THE STATE WHERE THE PROJECT IS LOCATED AND SHALL BE OF GREATER THAN THE AMOUNT BID TO AND THE TYPE OF WORK CONTEMPLATED IN THE PLANS AND SPECIFICATIONS. CONTRACTOR SHALL BE SKILLED AND REGULARLY ENGAGED IN THE GENERAL CLASS AND TYPE OF WORK CALLED FOR IN THE PLANS AND SPECIFICATIONS.
- CONTRACTOR SHALL INSPECT THE PROJECT PRIOR TO BIDDING TO SATISFY HIMSELF BY PERSONAL EXAMINATION OR BY SUCH OTHER MEANS AS HE MAY PREFER OF THE LOCATIONS OF THE PROPOSED WORK AND OF THE ACTUAL CONDITIONS OF AND AT THE SITE OF WORK. IF, DURING THE COURSE OF HIS EXAMINATION, A BIDDER FINDS FACTS OR CONDITIONS WHICH APPEAR TO HIM TO BE IN CONFLICT WITH THE LETTER OR SPIRIT OF THE PROJECT PLANS AND SPECIFICATIONS, HE SHALL CONTACT THE ENGINEER FOR ADDITIONAL INFORMATION AND EXPLANATION BEFORE SUBMITTING HIS BID. SUBMISSION OF A BID BY THE CONTRACTOR SHALL CONSTITUTE ACKNOWLEDGMENT THAT, IF AWARDED THE CONTRACT, HE HAS RELIED AND IS RELYING ON HIS OWN EXAMINATION OF (1) THE SITE OF THE WORK, (2) ACCESS TO THE SITE, AND (3) ALL OTHER DATA AND MATTERS REQUISITE TO THE FULFILLMENT OF THE OBLIGATIONS OF HIS CONTRACT. CONTRACTOR SHALL BE RESPONSIBLE FOR VERIFYING ANY INFORMATION PROVIDED BY THE ENGINEER IS NOT INTENDED TO BE A SUBSTITUTE FOR, OR A SUPPLEMENT TO, THE INDEPENDENT VERIFICATION BY THE CONTRACTOR TO THE EXTENT SUCH INDEPENDENT INVESTIGATION OR VERIFICATION IS DEEMED NECESSARY BY THE CONTRACTOR. CONTRACTOR SHALL ACKNOWLEDGE THAT HE HAS NOT RELIED SOLELY UPON OWNER-OR ENGINEER-FURNISHED INFORMATION REGARDING SITE CONDITIONS IN PREPARING AND SUBMITTING HIS BID.
- CONTRACTOR SHALL BE RESPONSIBLE TO PROVIDE ALL WATER, POWER, SANITARY FACILITIES AND TELEPHONE SERVICES AS REQUIRED FOR THE CONTRACTOR'S USE DURING CONSTRUCTION.
- CONTRACTOR SHALL BE HELD RESPONSIBLE FOR ANY FIELD CHANGES MADE WITHOUT PRIOR WRITTEN AUTHORIZATION FROM THE OWNER, ENGINEER, AND/OR GOVERNING AGENCIES.
- CONTRACTOR SHALL EXERCISE DUE CAUTION AND SHALL CAREFULLY PRESERVE BENCH MARKS, CONTROL POINTS, REFERENCE POINTS AND ALL SURVEY STAKES, AND SHALL BEAR ALL EXPENSES FOR REPLACEMENT AND/OR ERRORS CAUSED BY THEIR UNNECESSARY LOSS OR DISTURBANCE.
- CONTRACTOR SHALL ASSUME SOLE AND COMPLETE RESPONSIBILITY FOR JOBSITE CONDITIONS DURING THE COURSE OF CONSTRUCTION OF THIS PROJECT, INCLUDING SAFETY OF ALL PERSONS AND PROPERTY. THIS REQUIREMENT SHALL APPLY CONTINUOUSLY AND NOT BE LIMITED TO THE NORMAL WORKING HOURS. THE CONTRACTOR SHALL DEFEND, INDEMNIFY AND HOLD THE OWNER AND ENGINEER HARMLESS FROM ANY AND ALL LIABILITY, REAL OR ALLEGED, IN CONNECTION WITH THE PERFORMANCE OF WORK ON THIS PROJECT, EXCEPTING FOR LIABILITY ARISING FROM THE SOLE NEGLIGENCE OF THE OWNER OR THE ENGINEER.
- CONTRACTOR SHALL BE RESPONSIBLE FOR ADEQUATELY SCHEDULING INSPECTION AND TESTING OF ALL FACILITIES CONSTRUCTED UNDER THIS CONTRACT. ALL TESTING SHALL CONFORM TO THE REGULATORY AGENCY'S STANDARD SPECIFICATIONS. ALL TESTING AND INSPECTION SHALL BE PAID FOR BY THE OWNER. ALL RE-TESTING AND/OR RE-INSPECTION SHALL BE PAID FOR BY THE CONTRACTOR.
- IF EXISTING IMPROVEMENTS NEED TO BE DISTURBED OR REMOVED FOR THE PROPER PLACEMENT OF IMPROVEMENTS TO BE CONSTRUCTED BY THESE PLANS, THE CONTRACTOR SHALL BE RESPONSIBLE FOR PROTECTING EXISTING IMPROVEMENTS FROM DAMAGE. COST OF REPLACING OR REPAIRING EXISTING IMPROVEMENTS SHALL BE INCLUDED IN THE UNIT PRICE BID FOR ITEMS REQUIRING REMOVAL AND/OR REPLACEMENT. THERE WILL BE NO EXTRA COST DUE TO THE CONTRACTOR FOR REPLACING OR REPAIRING EXISTING IMPROVEMENTS.
- WHENEVER EXISTING FACILITIES ARE REMOVED, DAMAGED, BROKEN, OR CUT IN THE INSTALLATION OF THE WORK COVERED BY THESE PLANS OR SPECIFICATIONS, SAID FACILITIES SHALL BE REPLACED AT THE CONTRACTOR'S EXPENSE WITH MATERIALS EQUAL TO OR BETTER THAN THE MATERIALS USED IN THE ORIGINAL EXISTING FACILITIES. THE FINISHED PRODUCT SHALL BE SUBJECT TO THE APPROVAL OF THE OWNER, THE ENGINEER, AND THE RESPECTIVE REGULATORY AGENCY.
- CONTRACTOR SHALL MAINTAIN A NEATLY MARKED SET OF FULL-SIZE AS-BUILT RECORD DRAWINGS SHOWING THE FINAL LOCATION AND LAYOUT OF ALL STRUCTURES AND OTHER FACILITIES. AS-BUILT RECORD DRAWINGS SHALL REFLECT CHANGE ORDERS, ACCOMMODATIONS, AND ADJUSTMENTS TO ALL IMPROVEMENTS CONSTRUCTED. WHERE NECESSARY, SUPPLEMENTAL DRAWINGS SHALL BE PREPARED AND SUBMITTED BY THE CONTRACTOR PRIOR TO ACCEPTANCE OF THE PROJECT. THE CONTRACTOR SHALL DELIVER TO THE ENGINEER ONE SET OF NEATLY MARKED AS-BUILT RECORD DRAWINGS SHOWING THE INFORMATION REQUIRED ABOVE. AS-BUILT RECORD DRAWINGS SHALL BE REVIEWED AND THE COMPLETE AS-BUILT RECORD DRAWING SET SHALL BE CURRENT WITH ALL CHANGES AND DEVIATIONS RELIANT AS A PRECONDITION TO THE FINAL PROCESS PAYMENT APPROVAL AND/OR FINAL ACCEPTANCE.
- WHERE THE PLANS OR SPECIFICATIONS DESCRIBE PORTIONS OF THE WORK IN GENERAL TERMS BUT NOT IN COMPLETE DETAIL, IT IS UNDERSTOOD THAT ONLY THE BEST GENERAL PRACTICE IS TO PREVAIL AND THAT ONLY MATERIALS AND WORKMANSHIP OF THE HIGHEST QUALITY ARE TO BE USED.
- CONTRACTOR SHALL BE SKILLED AND REGULARLY ENGAGED IN THE GENERAL CLASS AND TYPE OF WORK CALLED FOR IN THE PROJECT PLANS AND SPECIFICATIONS. THEREFORE, THE OWNER IS RELYING UPON THE EXPERIENCE AND EXPERTISE OF THE CONTRACTOR. PRICES PROVIDED WITHIN THE CONTRACT DOCUMENTS SHALL INCLUDE ALL LABOR AND MATERIALS NECESSARY AND PROPER FOR THE WORK CONTEMPLATED AND THAT THE WORK BE COMPLETED IN ACCORDANCE WITH THE TRUE INTENT AND PURPOSE OF THESE PLANS AND SPECIFICATIONS. THE CONTRACTOR SHALL BE COMPETENT, KNOWLEDGEABLE AND HAVE SPECIAL SKILLS IN THE NATURE, EXTENT AND INHERENT CONDITIONS OF THE WORK TO BE PERFORMED. CONTRACTOR SHALL ALSO ACKNOWLEDGE THAT THERE ARE CERTAIN PECULIAR AND INHERENT CONDITIONS EXISTENT IN THE CONSTRUCTION OF THE PARTICULAR FACILITIES WHICH MAY CREATE, DURING THE CONSTRUCTION PROGRAM, UNUSUAL OR UNSAFE CONDITIONS HAZARDOUS TO PERSONS, PROPERTY AND THE ENVIRONMENT. CONTRACTOR SHALL BE AWARE OF SUCH PECULIAR RISKS AND HAVE THE SKILL AND EXPERIENCE TO FORESEE AND TO ADOPT PROTECTIVE MEASURES TO ADEQUATELY AND SAFELY PERFORM THE CONSTRUCTION WORK WITH RESPECT TO SUCH HAZARDS.
- CONTRACTOR SHALL BE RESPONSIBLE FOR THE REMOVAL OF ALL STRIPING AND/OR PAVEMENT MARKINGS NECESSARY TO THE EXISTING STRIPING INTO FUTURE STRIPING. METHOD OF REMOVAL SHALL BE BY GRINDING OR SANDBLASTING.
- CONTRACTOR SHALL PROVIDE ALL SHORING, BRACING, SLOPING OR OTHER PROVISIONS NECESSARY TO PROTECT WORKMEN FOR ALL AREAS TO BE EXCAVATED TO A DEPTH OF 4 FEET OR MORE. FOR EXCAVATION IN DEPTH, CONTRACTOR SHALL RECORD THE BLUE STAKES OR OTHER NUMBER AND FURNISH ORDER NUMBER TO OWNER AND ENGINEER PRIOR TO ANY EXCAVATION. IT WILL BE THE CONTRACTOR'S SOLE RESPONSIBILITY TO DIRECTLY CONTACT ANY OTHER UTILITY COMPANIES THAT ARE NOT MEMBERS OF BLUE STAKES. IT SHALL BE THE CONTRACTOR'S SOLE RESPONSIBILITY TO PROTECT ALL EXISTING UTILITIES SO THAT NO DAMAGE RESULTS TO THEM DURING THE PERFORMANCE OF THIS CONTRACT. ANY REPAIRS NECESSARY TO DAMAGED UTILITIES SHALL BE PAID FOR BY THE CONTRACTOR. THE CONTRACTOR SHALL BE REQUIRED TO COOPERATE WITH OTHER CONTRACTORS AND UTILITY COMPANIES INSTALLING NEW STRUCTURES, UTILITIES AND SERVICE TO THE PROJECT.
- CONTRACTOR SHALL NOT HOLE ALL UTILITIES TO DETERMINE IF CONFLICTS EXIST PRIOR TO BEGINNING ANY EXCAVATION. NOTIFY ENGINEER OF ANY CONFLICTS. CONTRACTOR SHALL VERIFY LOCATION AND INVERTS OF EXISTING UTILITIES TO WHICH NEW UTILITIES WILL BE CONNECTED. PRIOR TO COMMENCING ANY EXCAVATION WORK THE CONTRACTOR SHALL NOTIFY ALL UTILITY COMPANIES IN ACCORDANCE WITH THE REQUIRED PROCEDURES. CARE SHOULD BE TAKEN IN ALL EXCAVATIONS DUE TO POSSIBLE EXISTENCE OF UNRECORDED UTILITY LINES. EXCAVATION REQUIRED WITHIN PROXIMITY OF EXISTING UTILITY LINES SHALL BE DONE BY HAND. CONTRACTOR SHALL REPAIR ANY DAMAGE TO EXISTING UTILITY LINES OR STRUCTURES INCURRED DURING CONSTRUCTION OPERATIONS AT HIS EXPENSE.
- ALL VALVES AND MANHOLE COVERS SHALL BE RAISED OR LOWERED TO MEET FINISHED GRADE.
- CONTRACTOR SHALL CUT PIPES OFF FLUSH WITH THE INSIDE WALL OF THE BOX OR MANHOLE.
- CONTRACTOR SHALL GROUT AT CONNECTION OF PIPE TO BOX WITH NON-SHRINKING GROUT, INCLUDING PIPE VOIDS LEFT BY CUTTING PROCESS, TO A SMOOTH FINISH.
- CONTRACTOR SHALL GROUT WITH NON-SHRINK GROUT BETWEEN GRADE RINGS AND BETWEEN BOTTOM OF INLET LID FRAME AND TOP OF CONCRETE BOX.
- SILT AND DEBRIS IS TO BE CLEANED OUT OF ALL STORM DRAIN BOXES. CATCH BASINS ARE TO BE MAINTAINED IN A CLEANED CONDITION AS NEEDED UNTIL AFTER THE FINAL BOND RELEASE INSPECTION.
- CONTRACTOR SHALL CLEAN ASPHALT, TAR OR OTHER ADHESIVES OFF OF ALL MANHOLE LIDS AND INLET GRATES TO ALLOW ACCESS.
- EACH TRENCH SHALL BE EXCAVATED SO THAT THE PIPE CAN BE LAID TO THE ALIGNMENT AND GRADE AS REQUIRED. THE TRENCH WALL SHALL BE SO BRACED THAT THE WORKMEN MAY WORK SAFELY AND EFFICIENTLY. ALL TRENCHES SHALL BE DRAINED SO THE PIPE LAYING MAY TAKE PLACE IN DE-WATERED CONDITIONS.
- CONTRACTOR SHALL PROVIDE AND MAINTAIN AT ALL TIMES AMPLE MEANS AND DEVICES WITH WHICH TO REMOVE PROMPTLY AND TO PROPERLY DISPOSE OF ALL WATER ENTERING THE TRENCH EXCAVATION.
- MAINTAIN A MINIMUM 18" VERTICAL SEPARATION DISTANCE BETWEEN ALL UTILITY CROSSINGS.
- CONTRACTOR SHALL START INSTALLATION AT LOW POINT OF ALL NEW GRAVITY UTILITY LINES.
- ALL BOLTED FITTINGS MUST BE GREASED AND WRAPPED.
- UNLESS SPECIFICALLY NOTED OTHERWISE, MAINTAIN AT LEAST 2 FEET OF COVER OVER ALL STORM DRAIN LINES AT ALL TIMES (INCLUDING DURING CONSTRUCTION).
- ALL CULINARY WATER FACILITIES SHALL CONFORM TO THE TAYLOR-WEST WEBER WATER IMPROVEMENT DISTRICT STANDARD DRAWINGS AND SPECIFICATION.
- ITEMS UNIQUE TO CULINARY WATER CAN BE ELIMINATED FROM THESE NOTES AS LONG AS THE NOTE ABOUT CONFORMANCE TO TWW STANDARDS IS INCLUDED.
- ALL UNDERGROUND UTILITIES SHALL BE IN PLACE PRIOR TO INSTALLATION OF CURB, GUTTER, SIDEWALK AND STREET PAVING.
- CONTRACTOR SHALL INSTALL MAGNETIC LOCATING TAPE CONTINUOUSLY OVER ALL NONMETALLIC PIPE.
- THRUST BLOCKS & RESTRAINED JOINTS WITH MEGA-LUG ADAPTERS REQUIRED ON ALL BENDS AND FITTINGS USING BLUE BOLTS. PROTECT ALL BOLTS FROM BEING ENCASED IN CONCRETE. INSTALL PER MANUFACTURER RECOMMENDATIONS.

**Utility Notes:**

- CONTRACTOR SHALL COORDINATE LOCATION OF NEW "DRY UTILITIES" WITH THE APPROPRIATE UTILITY COMPANY, INCLUDING BUT NOT LIMITED TO: TELEPHONE SERVICE, GAS SERVICE, CABLE, POWER, INTERNET.
- EXISTING UTILITIES HAVE BEEN SHOWN ON THE PLANS USING A COMBINATION OF ON-SITE SURVEYS (BY OTHERS), PRIOR TO COMMENCING ANY WORK. IT SHALL BE THE CONTRACTOR'S RESPONSIBILITY TO HAVE EACH UTILITY COMPANY LOCATE IN THE FIELD, THEIR MAIN AND SERVICE LINES 48 HOURS IN ADVANCE OF PERFORMING ANY EXCAVATION WORK. THE CONTRACTOR SHALL RECORD THE BLUE STAKES ORDER NUMBER AND FURNISH ORDER NUMBER TO OWNER AND ENGINEER PRIOR TO ANY EXCAVATION. IT WILL BE THE CONTRACTOR'S SOLE RESPONSIBILITY TO DIRECTLY CONTACT ANY OTHER UTILITY COMPANIES THAT ARE NOT MEMBERS OF BLUE STAKES. IT SHALL BE THE CONTRACTOR'S SOLE RESPONSIBILITY TO PROTECT ALL EXISTING UTILITIES SO THAT NO DAMAGE RESULTS TO THEM DURING THE PERFORMANCE OF THIS CONTRACT. ANY REPAIRS NECESSARY TO DAMAGED UTILITIES SHALL BE PAID FOR BY THE CONTRACTOR. THE CONTRACTOR SHALL BE REQUIRED TO COOPERATE WITH OTHER CONTRACTORS AND UTILITY COMPANIES INSTALLING NEW STRUCTURES, UTILITIES AND SERVICE TO THE PROJECT.
- CONTRACTOR SHALL NOT HOLE ALL UTILITIES TO DETERMINE IF CONFLICTS EXIST PRIOR TO BEGINNING ANY EXCAVATION. NOTIFY ENGINEER OF ANY CONFLICTS. CONTRACTOR SHALL VERIFY LOCATION AND INVERTS OF EXISTING UTILITIES TO WHICH NEW UTILITIES WILL BE CONNECTED. PRIOR TO COMMENCING ANY EXCAVATION WORK THE CONTRACTOR SHALL NOTIFY ALL UTILITY COMPANIES IN ACCORDANCE WITH THE REQUIRED PROCEDURES. CARE SHOULD BE TAKEN IN ALL EXCAVATIONS DUE TO POSSIBLE EXISTENCE OF UNRECORDED UTILITY LINES. EXCAVATION REQUIRED WITHIN PROXIMITY OF EXISTING UTILITY LINES SHALL BE DONE BY HAND. CONTRACTOR SHALL REPAIR ANY DAMAGE TO EXISTING UTILITY LINES OR STRUCTURES INCURRED DURING CONSTRUCTION OPERATIONS AT HIS EXPENSE.
- ALL VALVES AND MANHOLE COVERS SHALL BE RAISED OR LOWERED TO MEET FINISHED GRADE.
- CONTRACTOR SHALL CUT PIPES OFF FLUSH WITH THE INSIDE WALL OF THE BOX OR MANHOLE.
- CONTRACTOR SHALL GROUT AT CONNECTION OF PIPE TO BOX WITH NON-SHRINKING GROUT, INCLUDING PIPE VOIDS LEFT BY CUTTING PROCESS, TO A SMOOTH FINISH.
- CONTRACTOR SHALL GROUT WITH NON-SHRINK GROUT BETWEEN GRADE RINGS AND BETWEEN BOTTOM OF INLET LID FRAME AND TOP OF CONCRETE BOX.
- SILT AND DEBRIS IS TO BE CLEANED OUT OF ALL STORM DRAIN BOXES. CATCH BASINS ARE TO BE MAINTAINED IN A CLEANED CONDITION AS NEEDED UNTIL AFTER THE FINAL BOND RELEASE INSPECTION.
- CONTRACTOR SHALL CLEAN ASPHALT, TAR OR OTHER ADHESIVES OFF OF ALL MANHOLE LIDS AND INLET GRATES TO ALLOW ACCESS.
- EACH TRENCH SHALL BE EXCAVATED SO THAT THE PIPE CAN BE LAID TO THE ALIGNMENT AND GRADE AS REQUIRED. THE TRENCH WALL SHALL BE SO BRACED THAT THE WORKMEN MAY WORK SAFELY AND EFFICIENTLY. ALL TRENCHES SHALL BE DRAINED SO THE PIPE LAYING MAY TAKE PLACE IN DE-WATERED CONDITIONS.
- CONTRACTOR SHALL PROVIDE AND MAINTAIN AT ALL TIMES AMPLE MEANS AND DEVICES WITH WHICH TO REMOVE PROMPTLY AND TO PROPERLY DISPOSE OF ALL WATER ENTERING THE TRENCH EXCAVATION.
- MAINTAIN A MINIMUM 18" VERTICAL SEPARATION DISTANCE BETWEEN ALL UTILITY CROSSINGS.
- CONTRACTOR SHALL START INSTALLATION AT LOW POINT OF ALL NEW GRAVITY UTILITY LINES.
- ALL BOLTED FITTINGS MUST BE GREASED AND WRAPPED.
- UNLESS SPECIFICALLY NOTED OTHERWISE, MAINTAIN AT LEAST 2 FEET OF COVER OVER ALL STORM DRAIN LINES AT ALL TIMES (INCLUDING DURING CONSTRUCTION).
- ALL CULINARY WATER FACILITIES SHALL CONFORM TO THE TAYLOR-WEST WEBER WATER IMPROVEMENT DISTRICT STANDARD DRAWINGS AND SPECIFICATION.
- ITEMS UNIQUE TO CULINARY WATER CAN BE ELIMINATED FROM THESE NOTES AS LONG AS THE NOTE ABOUT CONFORMANCE TO TWW STANDARDS IS INCLUDED.
- ALL UNDERGROUND UTILITIES SHALL BE IN PLACE PRIOR TO INSTALLATION OF CURB, GUTTER, SIDEWALK AND STREET PAVING.
- CONTRACTOR SHALL INSTALL MAGNETIC LOCATING TAPE CONTINUOUSLY OVER ALL NONMETALLIC PIPE.
- THRUST BLOCKS & RESTRAINED JOINTS WITH MEGA-LUG ADAPTERS REQUIRED ON ALL BENDS AND FITTINGS USING BLUE BOLTS. PROTECT ALL BOLTS FROM BEING ENCASED IN CONCRETE. INSTALL PER MANUFACTURER RECOMMENDATIONS.

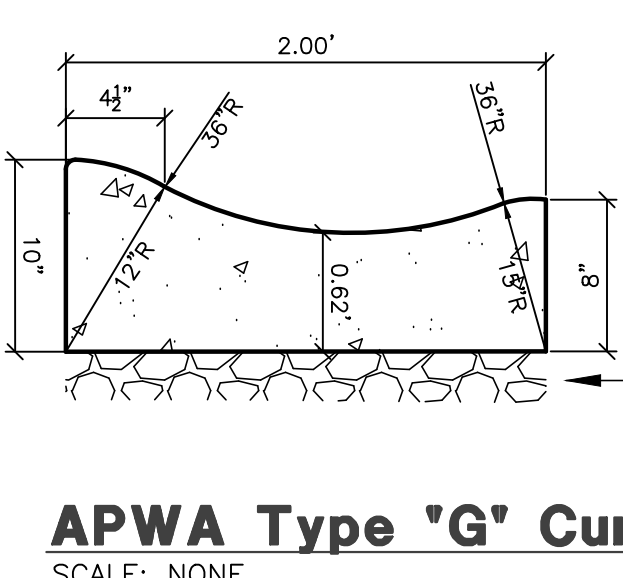

**Notice to Contractor:**

THE CONTRACTOR IS SPECIFICALLY CAUTIONED THAT THE LOCATION AND/OR ELEVATION OF EXISTING UNDERGROUND UTILITIES AS SHOWN ON THESE PLANS ARE BASED UPON RECORDS OF THE VARIOUS UTILITY COMPANIES AND/OR MUNICIPALITIES AND, WHERE POSSIBLE, MEASUREMENTS TAKEN IN THE FIELD. THE INFORMATION IS NOT TO BE RELIED UPON AS BEING EXACT OR COMPLETE. THE CONTRACTOR MUST CALL THE APPROPRIATE UTILITY COMPANIES AT LEAST 48 HOURS BEFORE ANY EXCAVATION TO REQUEST EXACT FIELD LOCATION OF UTILITIES. IT SHALL BE THE RESPONSIBILITY OF THE CONTRACTOR TO RELOCATE ALL EXISTING UTILITIES WHICH CONFLICT WITH THE PROPOSED IMPROVEMENTS SHOWN ON THESE PLANS.

THE CONTRACTOR AGREES THAT THEY SHALL ASSUME SOLE AND COMPLETE RESPONSIBILITY FOR JOB SITE CONDITIONS DURING THE COURSE OF CONSTRUCTION OF THIS PROJECT, INCLUDING SAFETY OF ALL PERSONS AND PROPERTY. THIS REQUIREMENT SHALL APPLY CONTINUOUSLY AND NOT BE LIMITED TO NORMAL WORKING HOURS; AND THAT THE CONTRACTOR SHALL DEFEND, INDEMNIFY, AND HOLD THE OWNER AND THE ENGINEERS HARMLESS FROM ANY AND ALL LIABILITY, REAL OR ALLEGED, IN CONNECTION WITH THE PERFORMANCE OF WORK ON THIS PROJECT.

- NOTE:**
- SAWCUT EXISTING ASPHALT INSIDE FROM OUTER EDGE FOR TACK SEAL OF NEW ASPHALT
  - CONTRACTOR TO VERIFY 2% MIN. AND 5% MAX SLOPE FROM EDGE OF ASPHALT TO LIP OF GUTTER

**Survey Control Note:**

THE CONTRACTOR OR SURVEYOR SHALL BE RESPONSIBLE FOR FOLLOWING THE NATIONAL SOCIETY OF PROFESSIONAL SURVEYORS (NSPS) MODEL STANDARDS FOR ANY SURVEYING OR CONSTRUCTION LAYOUT TO BE COMPLETED USING REEVE & ASSOCIATES, INC. SURVEY DATA OR CONSTRUCTION IMPROVEMENT PLANS. PRIOR TO PROCEEDING WITH CONSTRUCTION STAKING, THE SURVEYOR SHALL BE RESPONSIBLE FOR VERIFYING HORIZONTAL CONTROL FROM THE SURVEY MONUMENTS AND FOR VERIFYING ANY ADDITIONAL CONTROL POINTS SHOWN ON AN ALTA SURVEY, IMPROVEMENT PLAN, OR ANY ELECTRONIC DATA PROVIDED. THE SURVEYOR SHALL ALSO VERIFY THE BENCHMARKS AS SHOWN ON THE PLAN, AND VERIFY THEM AGAINST NO LESS THAN FIVE (5) EXISTING HARD IMPROVEMENT ELEVATIONS INCLUDED ON THESE PLANS OR ON ELECTRONIC DATA PROVIDED, IF ANY DISCREPANCIES ARE ENCOUNTERED, THE SURVEYOR SHALL IMMEDIATELY NOTIFY REEVE & ASSOCIATES, INC. AND RESOLVE THE DISCREPANCIES BEFORE PROCEEDING WITH ANY CONSTRUCTION STAKING.

**Erosion Control General Notes:**

THE CONTRACTOR TO USE BEST MANAGEMENT PRACTICES FOR PROVIDING EROSION CONTROL FOR CONSTRUCTION OF THIS PROJECT. ALL MATERIAL AND WORKMANSHIP SHALL CONFORM TO GOVERNING AGENCIES ORDINANCES AND ALL WORK SHALL BE SUBJECT TO INSPECTION BY THE COUNTIES. ALSO, INSPECTORS WILL HAVE THE RIGHT TO CHANGE THE FACILITIES AS NEEDED.

CONTRACTOR SHALL KEEP THE SITE WATERED TO CONTROL DUST. CONTRACTOR TO LOCATE A NEARBY HYDRANT FOR USE AND TO INSTALL TEMPORARY METER. CONSTRUCTION WATER COST TO BE INCLUDED IN BID.

WHEN GRADING OPERATIONS ARE COMPLETED AND THE DISTURBED GROUND IS LEFT OPEN FOR 14 DAYS OR MORE, THE AREA SHALL BE FURROWED PARALLEL TO THE CONTOURS.

THE CONTRACTOR SHALL MODIFY EROSION CONTROL MEASURES TO ACCOMMODATE PROJECT PLANNING.

ALL ACCESS TO PROPERTY WILL BE FROM PUBLIC RIGHT-OF-WAYS. THE CONTRACTOR IS REQUIRED BY STATE AND FEDERAL REGULATIONS TO PREPARE A STORM WATER POLLUTION PREVENTION PLAN AND FILE A "NOTICE OF INTENT" WITH THE GOVERNING AGENCIES.

- CONTRACTOR SHALL KEEP THE SITE WATERED TO CONTROL DUST. CONTRACTOR TO LOCATE A NEARBY HYDRANT FOR USE AND TO INSTALL TEMPORARY METER. CONSTRUCTION WATER COST TO BE INCLUDED IN BID.
- WHEN GRADING OPERATIONS ARE COMPLETED AND THE DISTURBED GROUND IS LEFT OPEN FOR 14 DAYS OR MORE, THE AREA SHALL BE FURROWED PARALLEL TO THE CONTOURS.
- THE CONTRACTOR SHALL MODIFY EROSION CONTROL MEASURES TO ACCOMMODATE PROJECT PLANNING.
- ALL ACCESS TO PROPERTY WILL BE FROM PUBLIC RIGHT-OF-WAYS. THE CONTRACTOR IS REQUIRED BY STATE AND FEDERAL REGULATIONS TO PREPARE A STORM WATER POLLUTION PREVENTION PLAN AND FILE A "NOTICE OF INTENT" WITH THE GOVERNING AGENCIES.

SEDIMENT DEPOSITS SHOULD BE REMOVED AFTER EACH RAINFALL. THEY MUST BE REMOVED WHEN THE LEVEL OF DEPOSITION REACHES APPROXIMATELY ONE-HALF THE HEIGHT OF BARRIER.

SEDIMENT TRACKED ONTO PAVED ROADS MUST BE CLEANED UP AS SOON AS PRACTICAL, BUT IN NO CASE LATER THAN THE END OF THE NORMAL WORK DAY. THE CLEAN UP WILL INCLUDE SWEEPING OF THE TRACKED MATERIAL, PICKING IT UP, AND DEPOSITING IT TO A CONTAINED AREA.

**EXPOSED SLOPES:**

ANY EXPOSED SLOPE THAT WILL REMAIN UNTOUCHED FOR LONGER THAN 14 DAYS MUST BE STABILIZED BY ONE OR MORE OF THE FOLLOWING METHODS:

- SPRINKLING DISTURBED AREAS WITH A TACKIFIER VIA HYDROSEED
- TRACKING STRAW PERPENDICULAR TO SLOPES
- INSTALLING A LIGHT-WEIGHT, TEMPORARY EROSION CONTROL BLANKET

**Maintenance:**

ALL BEST MANAGEMENT PRACTICES (BMP'S) SHOWN ON THIS PLAN MUST BE MAINTAINED AT ALL TIMES UNTIL PROJECT CLOSE-OUT.

THE CONTRACTOR'S RESPONSIBILITY SHALL INCLUDE MAKING BI-WEEKLY CHECKS ON ALL EROSION CONTROL MEASURES TO DETERMINE IF REPAIR OR SEDIMENT REMOVAL IS NECESSARY. CHECKS SHALL BE DOCUMENTED AND COPIES OF THE INSPECTIONS KEPT ON SITE.

SEDIMENT DEPOSITS SHOULD BE REMOVED AFTER EACH RAINFALL. THEY MUST BE REMOVED WHEN THE LEVEL OF DEPOSITION REACHES APPROXIMATELY ONE-HALF THE HEIGHT OF BARRIER.

SEDIMENT TRACKED ONTO PAVED ROADS MUST BE CLEANED UP AS SOON AS PRACTICAL, BUT IN NO CASE LATER THAN THE END OF THE NORMAL WORK DAY. THE CLEAN UP WILL INCLUDE SWEEPING OF THE TRACKED MATERIAL, PICKING IT UP, AND DEPOSITING IT TO A CONTAINED AREA.

**EXPOSED SLOPES:**

ANY EXPOSED SLOPE THAT WILL REMAIN UNTOUCHED FOR LONGER THAN 14 DAYS MUST BE STABILIZED BY ONE OR MORE OF THE FOLLOWING METHODS:

- SPRINKLING DISTURBED AREAS WITH A TACKIFIER VIA HYDROSEED
- TRACKING STRAW PERPENDICULAR TO SLOPES
- INSTALLING A LIGHT-WEIGHT, TEMPORARY EROSION CONTROL BLANKET

SEDIMENT DEPOSITS SHOULD BE REMOVED AFTER EACH RAINFALL. THEY MUST BE REMOVED WHEN THE LEVEL OF DEPOSITION REACHES APPROXIMATELY ONE-HALF THE HEIGHT OF BARRIER.

SEDIMENT TRACKED ONTO PAVED ROADS MUST BE CLEANED UP AS SOON AS PRACTICAL, BUT IN NO CASE LATER THAN THE END OF THE NORMAL WORK DAY. THE CLEAN UP WILL INCLUDE SWEEPING OF THE TRACKED MATERIAL, PICKING IT UP, AND DEPOSITING IT TO A CONTAINED AREA.

**EXPOSED SLOPES:**

ANY EXPOSED SLOPE THAT WILL REMAIN UNTOUCHED FOR LONGER THAN 14 DAYS MUST BE STABILIZED BY ONE OR MORE OF THE FOLLOWING METHODS:

- SPRINKLING DISTURBED AREAS WITH A TACKIFIER VIA HYDROSEED
- TRACKING STRAW PERPENDICULAR TO SLOPES
- INSTALLING A LIGHT-WEIGHT, TEMPORARY EROSION CONTROL BLANKET

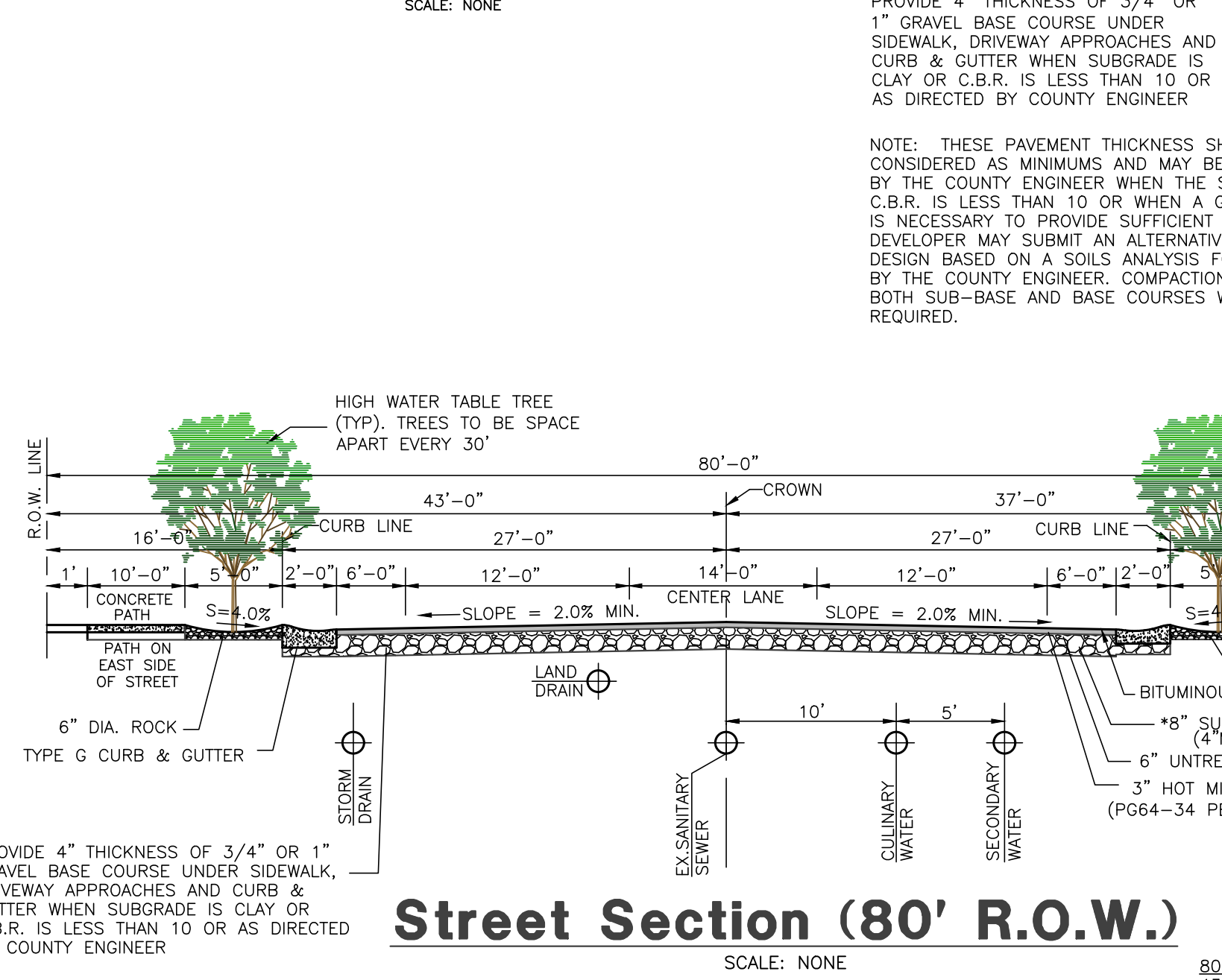
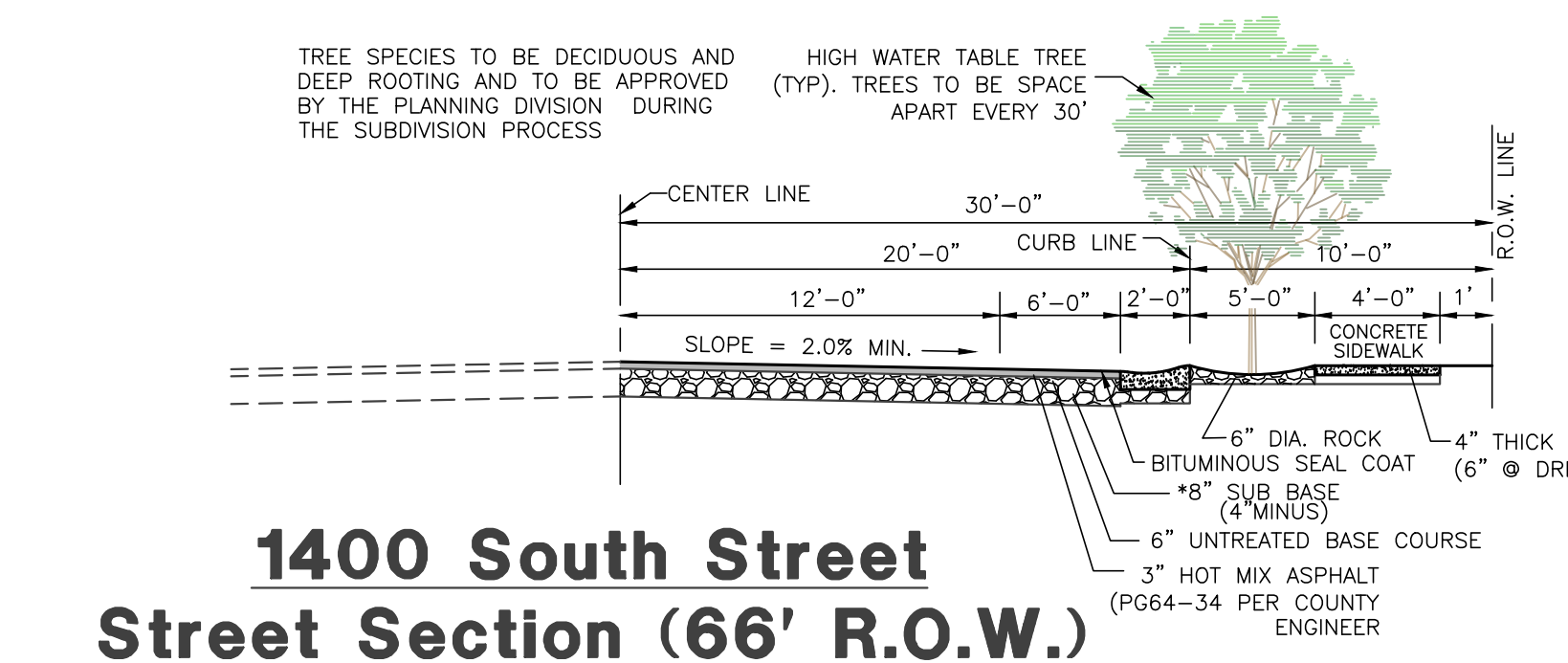

- SW LAT = PROPOSED SECONDARY WATER LATERAL
- LD LAT = PROPOSED LAND DRAIN LATERAL
- W LAT = PROPOSED WATER LATERAL
- SS LAT = PROPOSED SEWER LATERAL
- W/B = PROPOSED CULINARY WATER LINE
- EX.W = EXISTING CULINARY WATER LINE
- SW/B = PROPOSED SECONDARY WATER LINE
- EX.SW = EXISTING SECONDARY WATER LINE
- SS/B = PROPOSED SANITARY SEWER LINE
- EX.SS = EXISTING SANITARY SEWER LINE
- SD/15 = PROPOSED STORM DRAIN LINE
- EX.SD = EXISTING STORM DRAIN LINE
- LD/B = PROPOSED LAND DRAIN LINE
- EX.LD = EXISTING LAND DRAIN LINE
- IRR/18 = PROPOSED IRRIGATION LINE
- EX.IRR = EXISTING IRRIGATION LINE
- X X X = EXISTING FENCE LINE
- O O O = PROPOSED FENCE LINE
- DRAINAGE SWALE
- OHP = OVERHEAD POWER LINE
- FIRE HYDRANT
- EXISTING FIRE HYDRANT
- PROPOSED MANHOLE
- EXISTING MANHOLE
- PROPOSED SEWER CLEAN-OUT
- PROPOSED GATE VALVE
- EXISTING GATE VALVE
- PLUG & BLOCK
- AIR VAC ASSEMBLY
- DUAL SECONDARY METER
- SINGLE SECONDARY METER

**Legend**

- PROPOSED WATER METER
- EXISTING WATER METER
- PROPOSED REDUCER
- EXISTING REDUCER
- PROPOSED CATCH BASIN
- EXISTING CATCH BASIN
- PLUG W/ 2" BLOW-OFF
- STREET LIGHT
- POWER POLE
- BASEMENT FLOOR ELEVATION
- BUILDING
- BOTTOM OF STAIRS
- BOTTOM OF WALL
- BEGINNING POINT
- CURB & GUTTER
- CATCH BASIN
- CUBIC FEET
- CUBIC FEET PER SECOND
- ENDING POINT
- FINISH FLOOR
- FINISH FLOOR ELEVATION
- FINISHED GRADE
- FIRE HYDRANT
- FLOW LINE
- GRADE BREAK
- INVERT
- LINEAR FEET
- NATURAL GRADE
- OVERHEAD POWER
- POINT OF CURVATURE
- POWER/UTILITY POLE
- POINT OF RETURN CURVATURE
- POINT OF TANGENCY
- PUBLIC UTILITY BASEMENT
- REINFORCED CONCRETE PIPE
- RIM OF MANHOLE
- RIGHT-OF-WAY
- STORM DRAIN
- STREET LIGHT
- SANITARY SEWER
- TOP BACK OF CURB
- TOP OF ASPHALT
- TOP OF CONCRETE
- TOP OF FINISHED FLOOR
- TOP OF STAIRS
- TOP OF WALL
- TOP OF SIDEWALK
- UNDERGROUND POWER
- CULINARY WATER
- WATER METER
- EXISTING ASPHALT PAVEMENT
- PROPOSED ASPHALT PAVEMENT
- PROPOSED CONCRETE
- PROPOSED GRAVEL
- EXISTING CONTOUR GRADE
- PROPOSED CONTOUR GRADE
- PROPOSED SERVICE SLEEVE

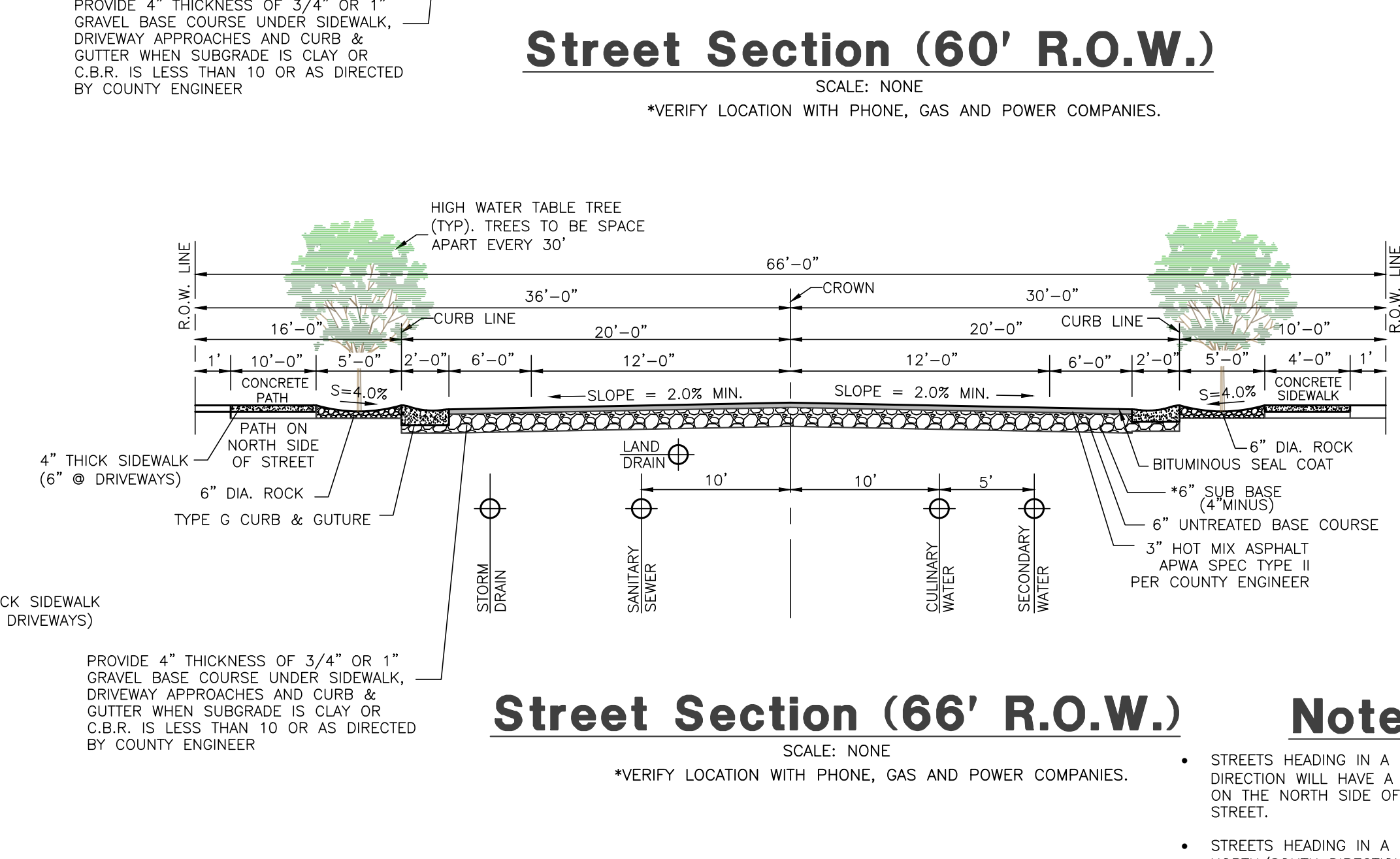
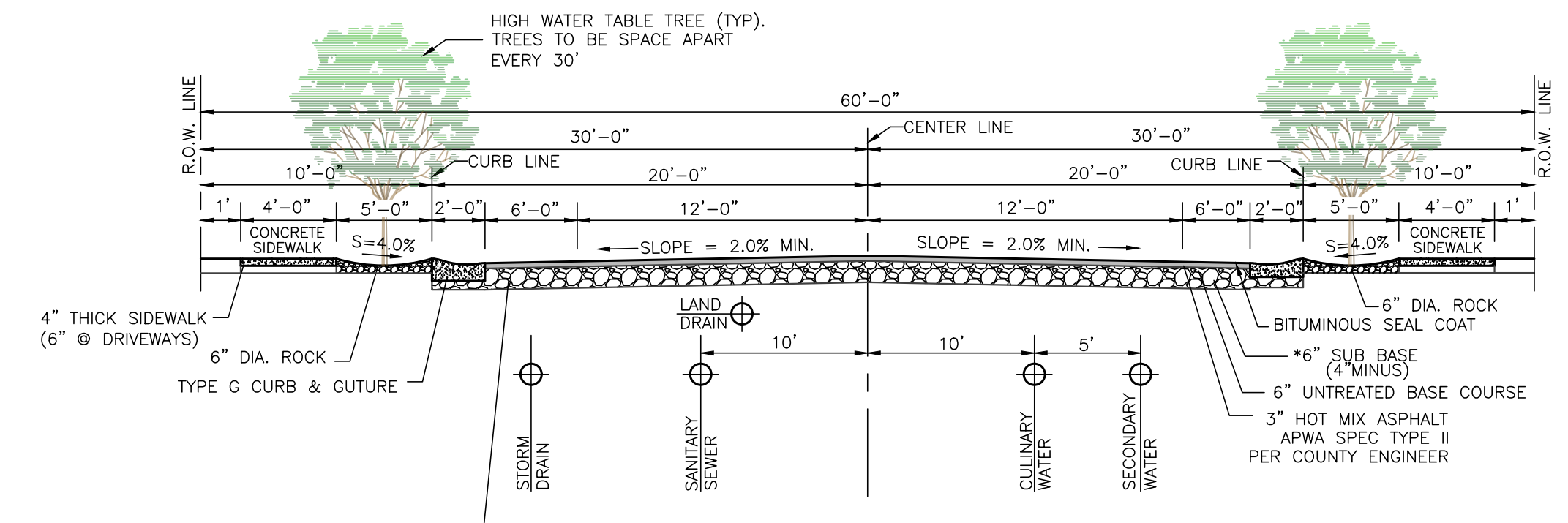

**Notes**

- STREETS HEADING IN A EAST/WEST DIRECTION WILL HAVE A 10' PATH ON THE NORTH SIDE OF THE STREET.
- STREETS HEADING IN A NORTH/SOUTH DIRECTION WILL HAVE A 10' PATH ON THE EAST SIDE OF THE STREET.

**Reeve & Associates, Inc.**  
5160 SOUTH 1500 WEST, RIVERDALE, UTAH 84405  
TEL: (801) 671-1100  
WWW.REEVE-AND-ASSOCIATES.COM

**PROFESSIONAL ENGINEER**  
J. NATE REEVE  
375328  
2/21/2024  
STATE OF UTAH

**REVISIONS**

DATE	DESCRIPTION
08.01.2023	NE County Comments
08.07.2023	NE Irr. & Wtr. Comm.
12.13.2023	NE Utility Outfall

**Anselmi Acres Subdivision**  
WEBER COUNTY, UTAH

**Notes/Legend/Street Cross-Section**

**Project Info.**

Engineer: J. NATE REEVE, P.E.  
 Drafter: N. FICKLIN  
 Begin Date: MAY, 2023  
 Name: ANSELMI ACRES SUBDIVISION  
 Number: 7152-19

**18** Total Sheets

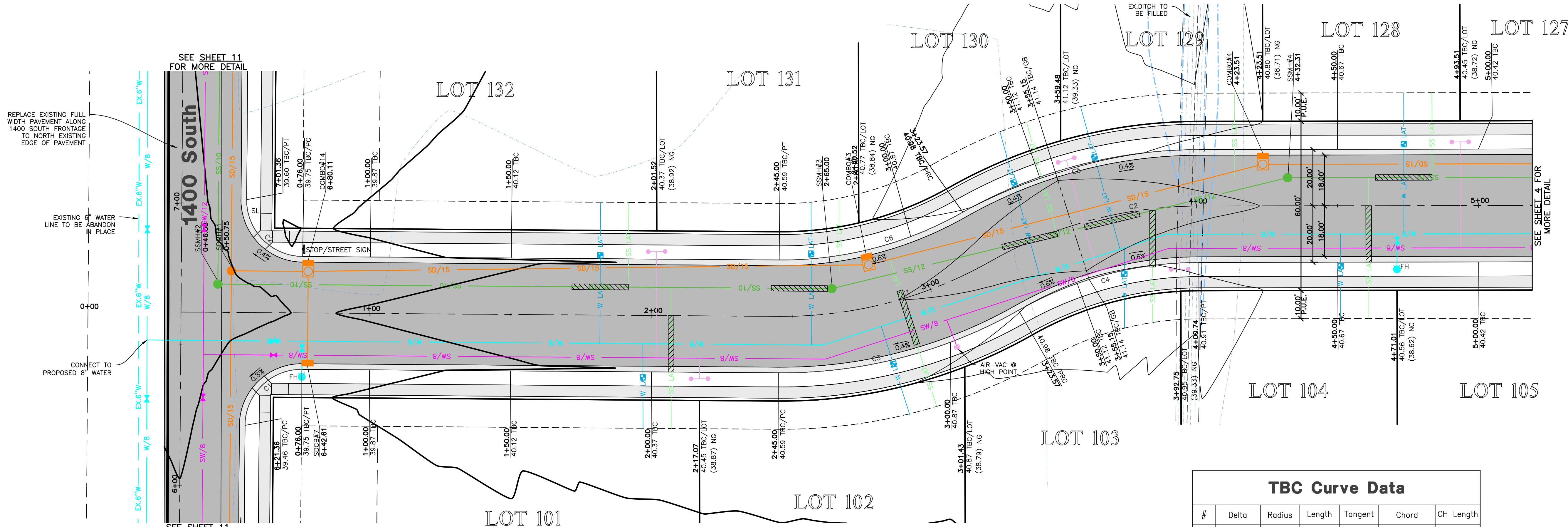

4125 West 0+00.00 - 5+00.00

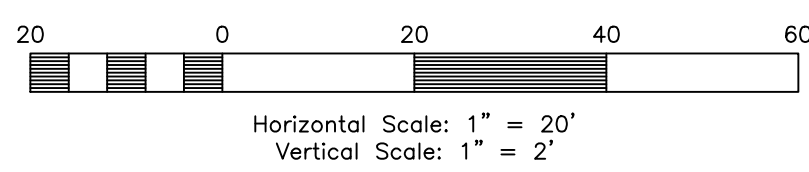

**Centerline Curve Data**

#	Delta	Radius	Length	Tangent	Chord	CH Length
C1	30°00'28"	150.00'	78.56'	40.20'	S13°57'40"E	77.67'
C2	29°28'41"	150.00'	77.17'	39.46'	S14°13'34"E	76.33'

**TBC Curve Data**

#	Delta	Radius	Length	Tangent	Chord	CH Length
C1	90°00'00"	20.00'	31.42'	20.00'	N43°57'26"W	28.28'
C2	90°00'00"	20.00'	31.42'	20.00'	S46°02'34"W	28.28'
C3	30°00'28"	170.00'	89.04'	45.56'	S13°57'40"E	88.02'
C4	29°28'41"	130.00'	66.88'	34.20'	N14°13'34"W	66.15'
C5	29°28'41"	170.00'	87.46'	44.72'	N14°13'34"W	86.50'
C6	30°00'28"	130.00'	68.09'	34.84'	S13°57'40"E	67.31'

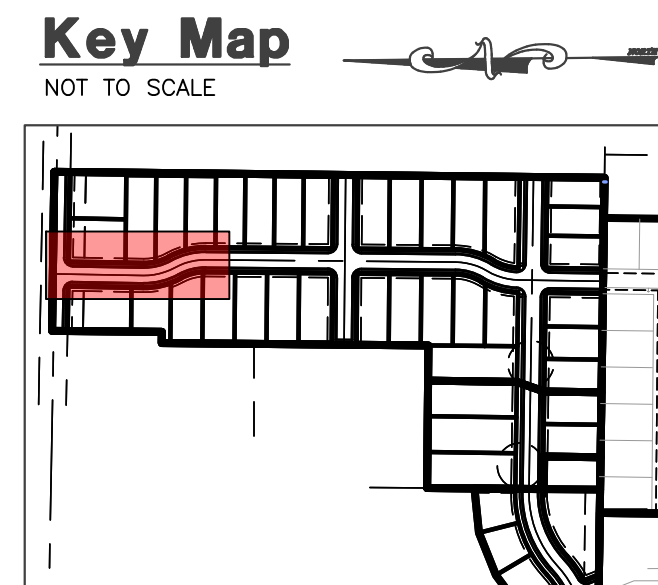
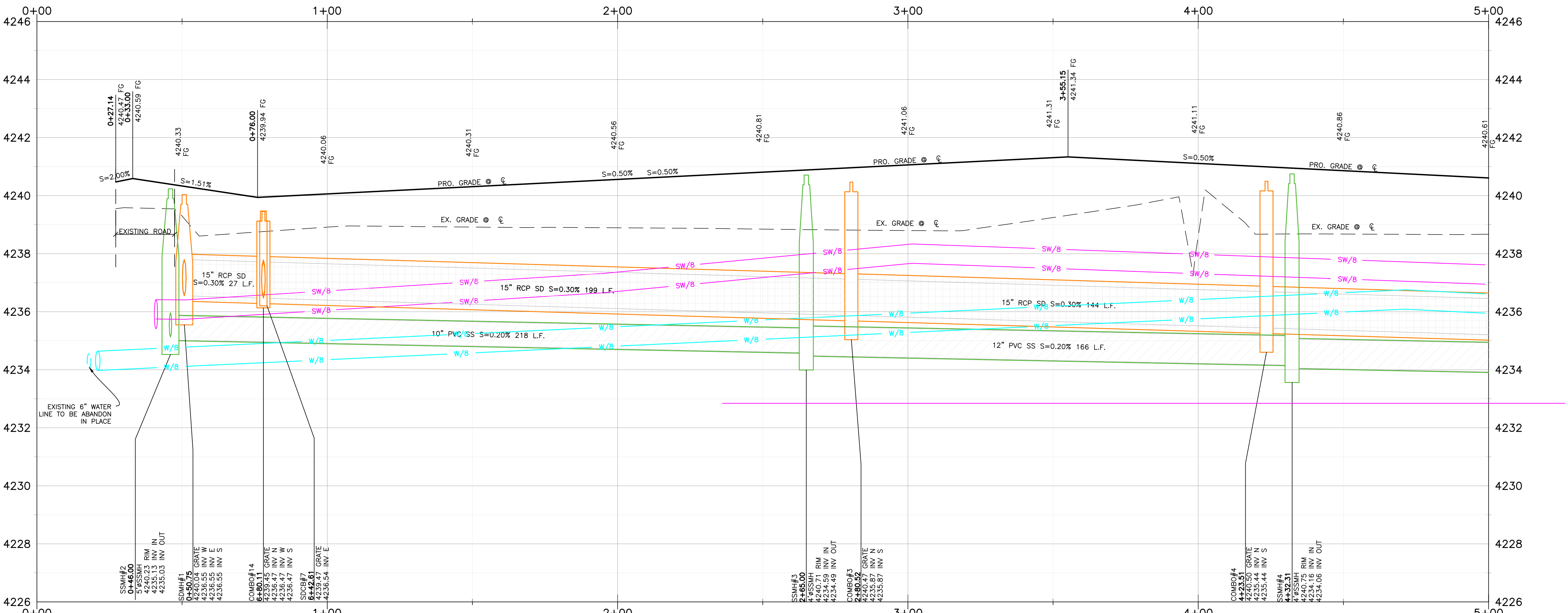

**Construction Notes:**

- CULINARY WATER**  
NOTE: 4" MIN. COVER REQUIRED OVER CW LINES  
W/8 - 8" PVC C900 DR-18 WATER LINE  
W - 1" SDR-9 POLY SERVICE LATERAL
- SANITARY SEWER**  
SS/4 - 4" PVC SDR-35 SERVICE LATERAL  
SS/8 - 8" PVC SDR-35 SEWER LINE
- STORM DRAIN**  
SD/12 - 12" RCP CLASS III STORM DRAIN  
SD/15 - 15" RCP CLASS III STORM DRAIN  
SD/18 - 18" RCP CLASS III STORM DRAIN
- ALL STORM DRAIN STRUCTURES TO HAVE MINIMUM 6" SUMP UNLESS OTHERWISE LISTED.
- SECONDARY WATER**  
SW/8 - 8" PVC C-900 DR-14 SECONDARY WATER LINE  
SW/12 - 12" PVC C-900 DR-14 SECONDARY WATER LINE  
SW - SECONDARY SERVICE LATERAL PER COUNTY STANDARDS
- IRRIGATION WATER**  
IRR/18 - 18" RCP CLASS III IRRIGATION PIPE

- NOTE:**
- ALL CONSTRUCTION IS TO CONFORM TO THE COUNTY STANDARD DRAWINGS AND SPECIFICATIONS.
  - CONSTRUCT HANDICAP RAMP PER ADA AND COUNTY REQUIREMENTS.
  - PROVIDE 18" VERTICAL CLEARANCE FOR WATER OVER/UNDER SEWER.
  - WHEN STANDARD 18" VERTICAL CLEARANCE CAN NOT BE MAINTAINED FOR WATER LATERALS CROSSING SEWER MAINS, SEWER MAIN MUST BE SLEEVED 20" CENTERED AT CROSSING.
  - WHEN STANDARD 18" VERTICAL CLEARANCE CAN NOT BE MAINTAINED FOR SEWER LATERALS CROSSING WATER MAINS, SEWER LATERAL MUST BE SLEEVED 20" ON CENTER AT CROSSING.
  - DEPTH OF WATER TO BE 4" MIN. BELOW FINISHED GRADE.
  - ALL EXISTING DITCHES THAT ARE BEING FILLED IN, MUST HAVE STRUCTURAL FILL IN ALL RIGHT-OF-WAY AND BUILDING FOOTPRINTS.
  - PVC SLEEVES TO BE INSTALLED UNDER PATHWAY FOR SPRINKLER USE.
  - CONTRACTOR TO INSTALL ALL SLEEVES AS REQUIRED FOR THE RESIDENTIAL DEVELOPMENT.
- MINIMUM SLEEVE SIZE REQUIREMENT:**  
CASING 4" SEWER LATERAL = 8"x20" CENTERED AT CROSSING  
CASING 8" SEWER MAIN = 12"x20" CENTERED AT CROSSING  
CASING 12" SEWER MAIN = 16"x20" CENTERED AT CROSSING  
CASING 8" WATER MAIN = 12"x20" CENTERED AT CROSSING

**Reeve & Associates, Inc.**  
LAND PLANNERS • CIVIL ENGINEERS • LAND SURVEYORS  
TRAFFIC ENGINEERS • STRUCTURAL ENGINEERS • LANDSCAPE ARCHITECTS

**REVISIONS**

DATE	DESCRIPTION
08.01.2023	NE County Comments
08.07.2023	NE Irr. & Wtr. Comm.
12.13.2023	NE Utility Outfall

**Anselmi Acres Subdivision**  
WEBER COUNTY, UTAH

**4125 West 0+00.00 - 5+00.00**



**Project Info.**  
Engineer: J. NATE REEVE, P.E.  
Drafter: N. FICKLIN  
Begin Date: MAY, 2023  
Name: ANSELMI ACRES SUBDIVISION  
Number: 7152-19

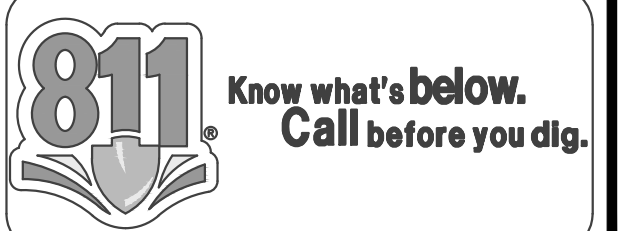

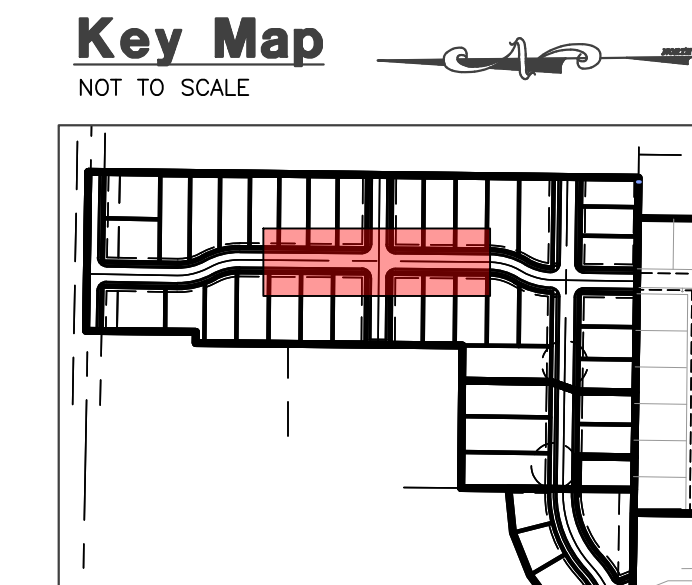

**Reeve & Associates, Inc.**  
 5160 SOUTH 1500 WEST, RIVERDALE, UTAH 84405  
 TEL: (801) 621-3100 www.reeve.co

**RA**  
 LAND PLANNERS • CIVIL ENGINEERS • LAND SURVEYORS  
 TRAFFIC ENGINEERS • STRUCTURAL ENGINEERS • LANDSCAPE ARCHITECTS

REVISIONS

DATE	DESCRIPTION
08.01.2023	NE County Comments
08.07.2023	NE Irr. & Wtr. Comm.
12.13.2023	NE Utility Outfall

**Construction Notes:**

- CULINARY WATER**  
 NOTE: 4" MIN. COVER REQUIRED OVER CW LINES  
 W/8 - 8" PVC C900 DR-18 WATER LINE  
 W - 1" SDR-9 POLY SERVICE LATERAL
- SANITARY SEWER**  
 SS/4 - 4" PVC SDR-35 SERVICE LATERAL  
 SS/8 - 8" PVC SDR-35 SEWER LINE
- STORM DRAIN**  
 SD/12 - 12" RCP CLASS III STORM DRAIN  
 SD/15 - 15" RCP CLASS III STORM DRAIN  
 SD/18 - 18" RCP CLASS III STORM DRAIN
- ALL STORM DRAIN STRUCTURES TO HAVE MINIMUM 6" SUMP UNLESS OTHERWISE LISTED.
- SECONDARY WATER**  
 SW/8 - 8" PVC C-900 DR-14 SECONDARY WATER LINE  
 SW/12 - 12" PVC C-900 DR-14 SECONDARY WATER LINE  
 SW - SECONDARY SERVICE LATERAL PER COUNTY STANDARDS
- IRRIGATION WATER**  
 IRR/18 - 18" RCP CLASS III IRRIGATION PIPE

- NOTE:
- ALL CONSTRUCTION IS TO CONFORM TO THE COUNTY STANDARD DRAWINGS AND SPECIFICATIONS.
  - CONSTRUCT HANDICAP RAMP PER ADA AND COUNTY REQUIREMENTS.
  - PROVIDE 18" VERTICAL CLEARANCE FOR WATER OVER/UNDER SEWER.
  - WHEN STANDARD 18" VERTICAL CLEARANCE CAN NOT BE MAINTAINED FOR WATER LATERALS CROSSING SEWER MAINS, SEWER MAIN MUST BE SLEEVED 20" CENTERED AT CROSSING.
  - WHEN STANDARD 18" VERTICAL CLEARANCE CAN NOT BE MAINTAINED FOR SEWER LATERALS CROSSING WATER MAINS, SEWER LATERAL MUST BE SLEEVED 20" ON CENTER AT CROSSING.
  - DEPTH OF WATER TO BE 4" MIN. BELOW FINISHED GRADE.
  - ALL EXISTING DITCHES THAT ARE BEING FILLED IN, MUST HAVE STRUCTURAL FILL IN ALL RIGHT-OF-WAY AND BUILDING FOOTPRINTS.
  - PVC SLEEVES TO BE INSTALLED UNDER PATHWAY FOR SPRINKLER USE.
  - CONTRACTOR TO INSTALL ALL SLEEVES AS REQUIRED FOR THE RESIDENTIAL DEVELOPMENT.
- MINIMUM SLEEVE SIZE REQUIREMENT:**  
 CASING 4" SEWER LATERAL = 8"x20" CENTERED AT CROSSING  
 CASING 8" SEWER MAIN = 12"x20" CENTERED AT CROSSING  
 CASING 12" SEWER MAIN = 16"x20" CENTERED AT CROSSING  
 CASING 8" WATER MAIN = 12"x20" CENTERED AT CROSSING

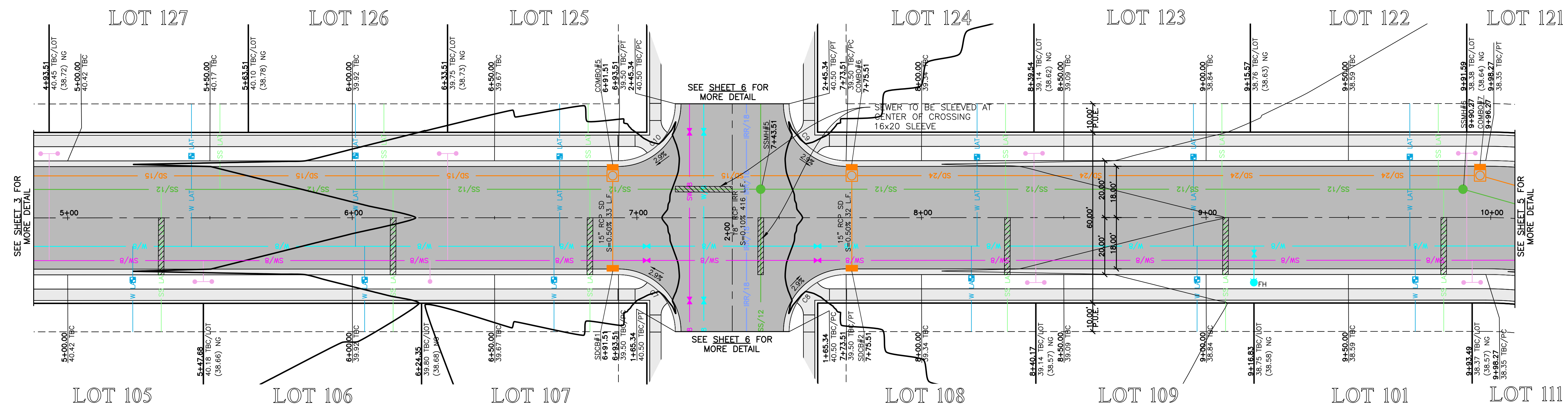

**4125 West 5+00.00 - 10+00.00**

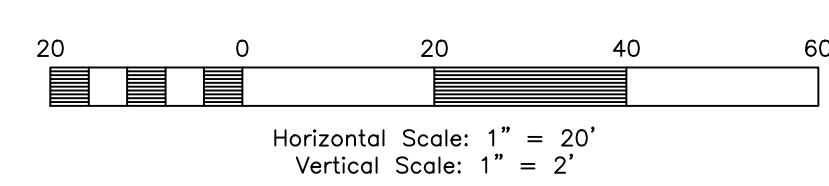

**TBC Curve Data**

#	Delta	Radius	Length	Tangent	Chord	CH Length
C7	90°00'00"	20.00'	31.42'	20.00'	N45°30'47"E	28.28'
C8	90°00'00"	20.00'	31.42'	20.00'	N44°29'13"W	28.28'
C9	90°00'00"	20.00'	31.42'	20.00'	S45°30'47"W	28.28'
C10	90°00'00"	20.00'	31.42'	20.00'	S44°29'13"E	28.28'

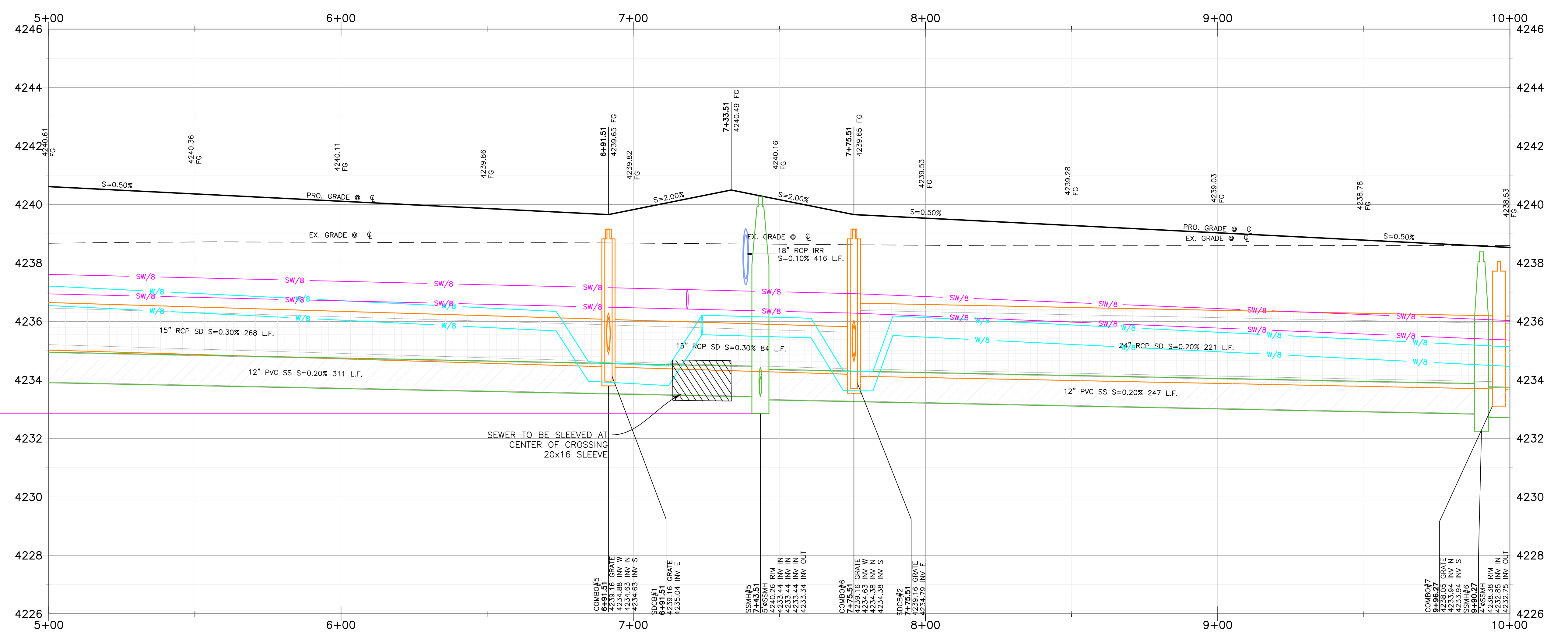

**Anselmi Acres Subdivision**  
 WEBER COUNTY, UTAH  
**4125 West 5+00.00 - 10+00.00**

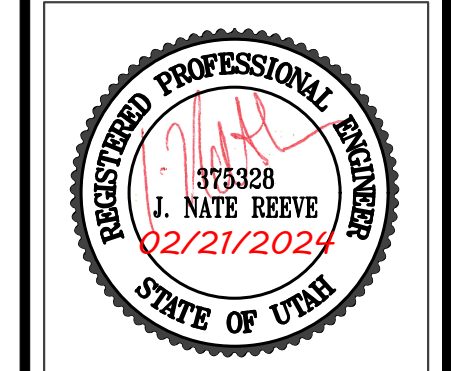

**Project Info.**  
 Engineer: J. NATE REEVE, P.E.  
 Drafter: N. FICKLIN  
 Begin Date: MAY, 2023  
 Name: ANSELMI ACRES SUBDIVISION  
 Number: 7152-19



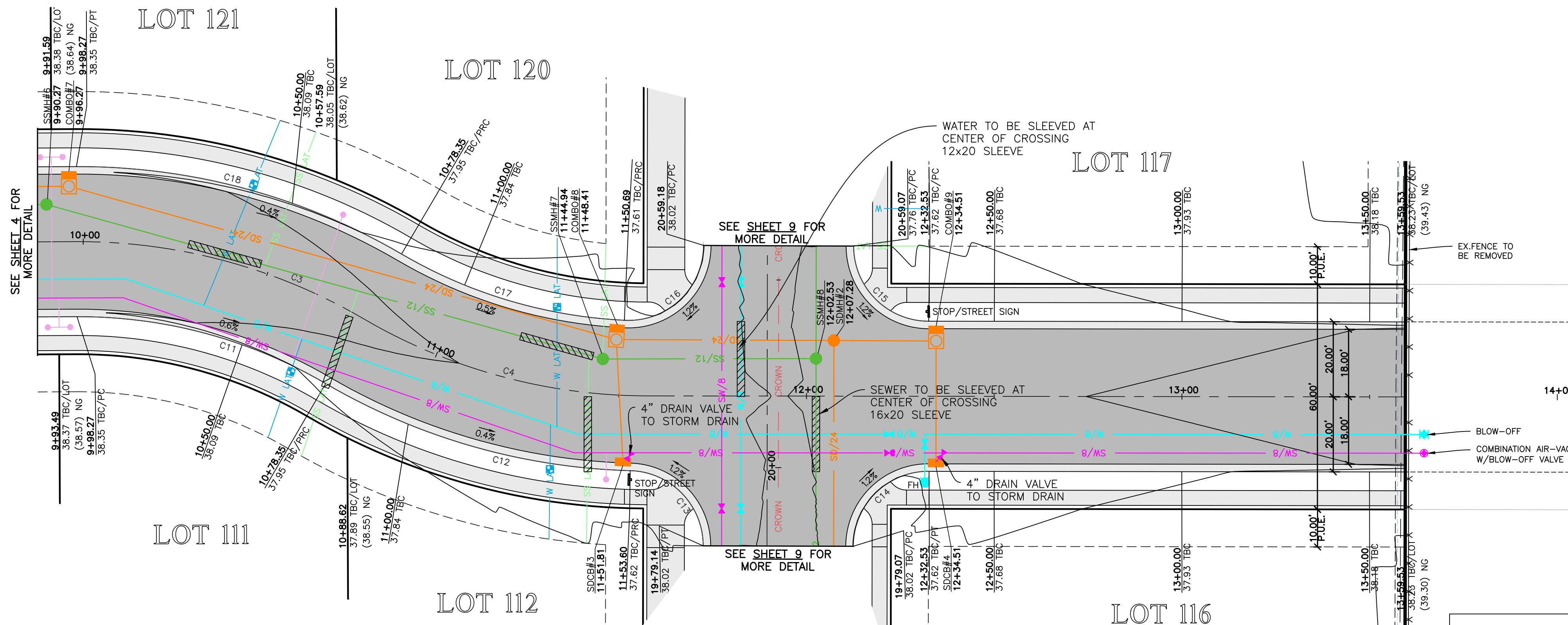

**4125 West 10+00.00 -14+00.00**

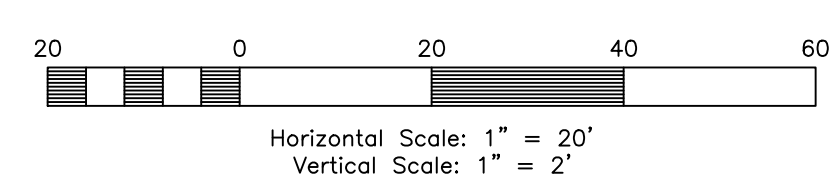

**Centerline Curve Data**

#	Delta	Radius	Length	Tangent	Chord	CH Length
C3	30°35'20"	150.00'	80.08'	41.02'	S15°48'27"W	79.13'
C4	30°16'08"	150.00'	79.24'	40.57'	S15°58'03"W	78.33'

**TBC Curve Data**

#	Delta	Radius	Length	Tangent	Chord	CH Length
C11	30°35'20"	130.00'	69.40'	35.55'	N15°48'27"E	68.58'
C12	28°44'31"	170.00'	85.28'	43.56'	S16°43'52"W	84.39'
C13	88°28'20"	20.00'	30.88'	19.47'	N46°35'46"E	27.90'
C14	90°00'03"	20.00'	31.42'	20.00'	N44°10'03"W	28.28'
C15	89°59'57"	20.00'	31.42'	20.00'	S45°49'57"W	28.28'
C16	92°38'23"	20.00'	32.34'	20.94'	S42°50'53"E	28.93'
C17	27°37'49"	130.00'	62.69'	31.97'	S17°17'13"W	62.09'
C18	30°35'20"	170.00'	90.76'	46.49'	N15°48'27"E	89.69'

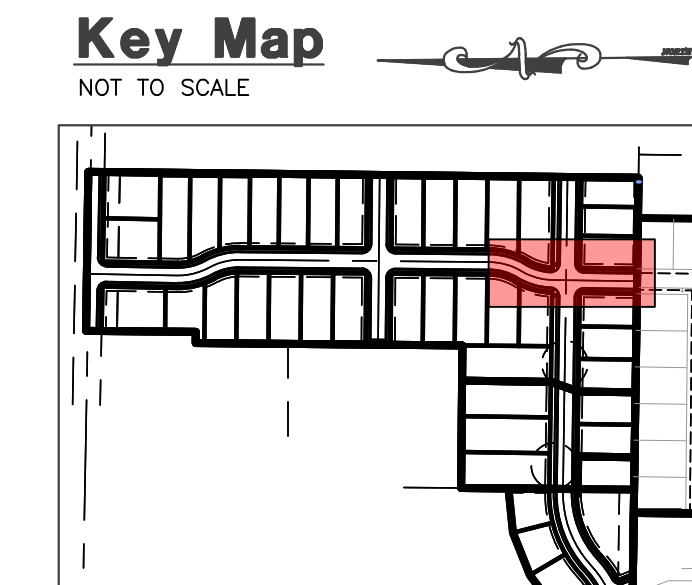
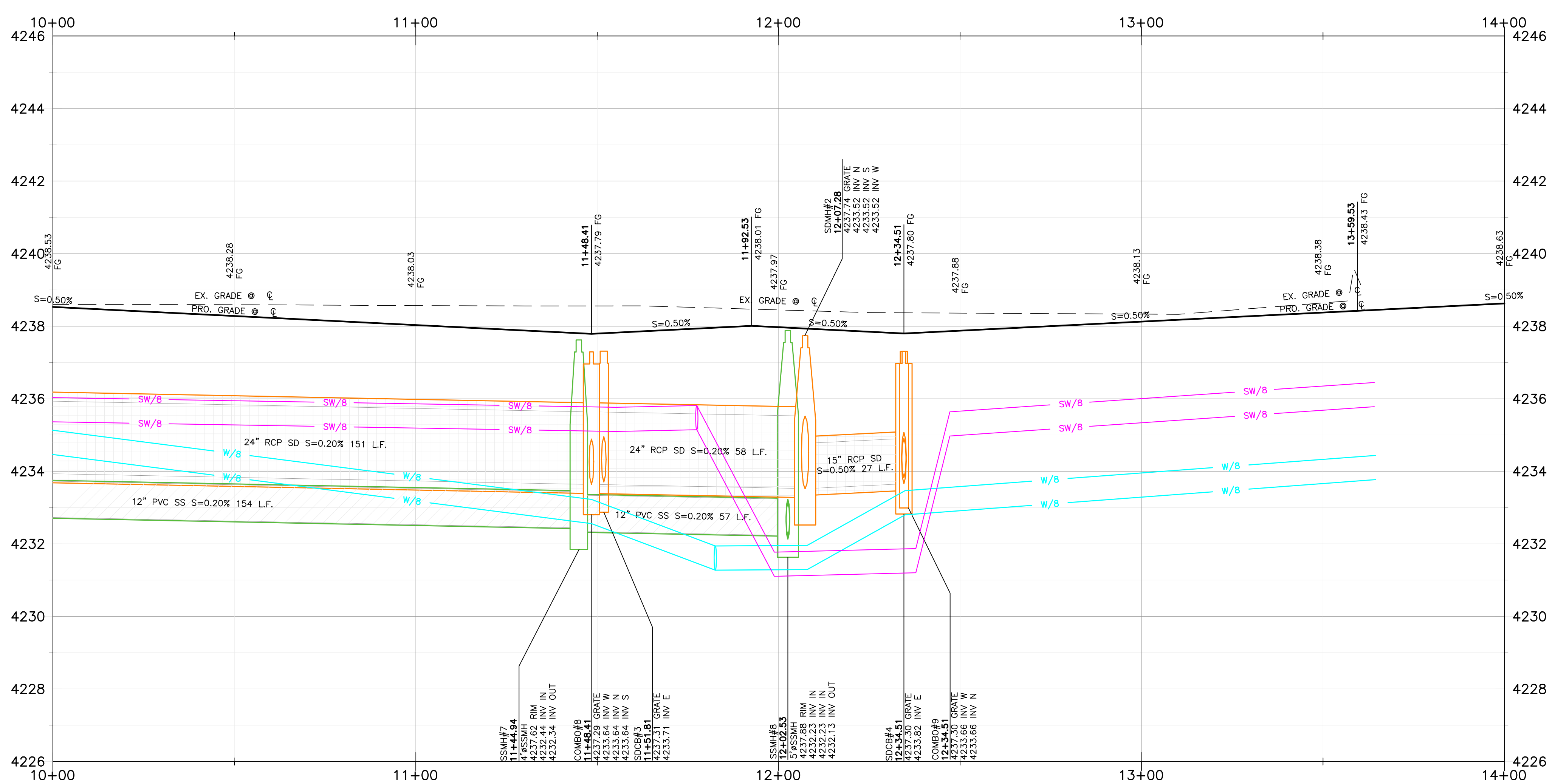

**Construction Notes:**

- CULINARY WATER**  
 NOTE: 4' MIN. COVER REQUIRED OVER CW LINES  
 W/8 - 8" PVC C900 DR-18 WATER LINE  
 W - 1" SDR-9 POLY SERVICE LATERAL
- SANITARY SEWER**  
 SS/4 - 4" PVC SDR-35 SERVICE LATERAL  
 SS/8 - 8" PVC SDR-35 SEWER LINE
- STORM DRAIN**  
 SD/12 - 12" RCP CLASS III STORM DRAIN  
 SD/15 - 15" RCP CLASS III STORM DRAIN  
 SD/18 - 18" RCP CLASS III STORM DRAIN
- ALL STORM DRAIN STRUCTURES TO HAVE MINIMUM 6" SUMP UNLESS OTHERWISE LISTED.
- SECONDARY WATER**  
 SW/8 - 8" PVC C-900 DR-14 SECONDARY WATER LINE  
 SW/12 - 12" PVC C-900 DR-14 SECONDARY WATER LINE  
 SW - SECONDARY SERVICE LATERAL PER COUNTY STANDARDS
- IRRIGATION WATER**  
 IRR/18 - 18" RCP CLASS III IRRIGATION PIPE

- NOTE:**
- ALL CONSTRUCTION IS TO CONFORM TO THE COUNTY STANDARD DRAWINGS AND SPECIFICATIONS.
  - CONSTRUCT HANDICAP RAMP PER ADA AND COUNTY REQUIREMENTS.
  - PROVIDE 18" VERTICAL CLEARANCE FOR WATER OVER/UNDER SEWER.
  - WHEN STANDARD 18" VERTICAL CLEARANCE CAN NOT BE MAINTAINED FOR WATER LATERALS CROSSING SEWER MAINS, SEWER MAIN MUST BE SLEEVED 20" CENTERED AT CROSSING.
  - WHEN STANDARD 18" VERTICAL CLEARANCE CAN NOT BE MAINTAINED FOR SEWER LATERALS CROSSING WATER MAINS, SEWER LATERAL MUST BE SLEEVED 20" ON CENTER AT CROSSING.
  - DEPTH OF WATER TO BE 4' MIN. BELOW FINISHED GRADE.
  - ALL EXISTING DITCHES THAT ARE BEING FILLED IN, MUST HAVE STRUCTURAL FILL IN ALL RIGHT-OF-WAY AND BUILDING FOOTPRINTS.
  - PVC SLEEVES TO BE INSTALLED UNDER PATHWAY FOR SPRINKLER USE.
  - CONTRACTOR TO INSTALL ALL SLEEVES AS REQUIRED FOR THE RESIDENTIAL DEVELOPMENT.
- MINIMUM SLEEVE SIZE REQUIREMENT:**  
 CASING 4" SEWER LATERAL = 8"x20" CENTERED AT CROSSING  
 CASING 8" SEWER MAIN = 12"x20" CENTERED AT CROSSING  
 CASING 12" SEWER MAIN = 16"x20" CENTERED AT CROSSING  
 CASING 8" WATER MAIN = 12"x20" CENTERED AT CROSSING

**Reeve & Associates, Inc.**  
 5160 SOUTH 1500 WEST, RIVERDALE, UTAH 84405  
 LAND PLANNERS • CIVIL ENGINEERS • LAND SURVEYORS  
 TRAFFIC ENGINEERS • STRUCTURAL ENGINEERS • LANDSCAPE ARCHITECTS

**REVISIONS**

DATE	DESCRIPTION
08.01.2023	NE County Comments
08.07.2023	NE Irr. & Wtr. Comm.
12.13.2023	NE Utility Outfall

**Anselmi Acres Subdivision**  
 WEBER COUNTY, UTAH

**4125 West 10+00.00 -14+00.00**

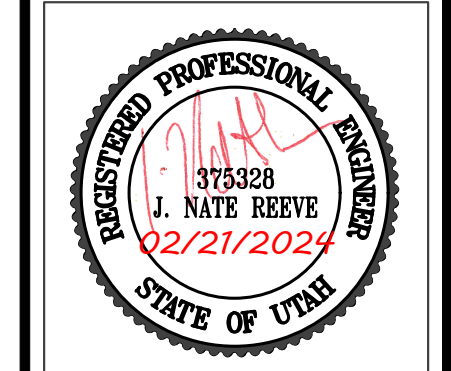

**Project Info.**  
 Engineer: J. NATE REEVE, P.E.  
 Drafter: N. FICKLIN  
 Begin Date: MAY, 2023  
 Name: ANSELMI ACRES SUBDIVISION  
 Number: 7152-19



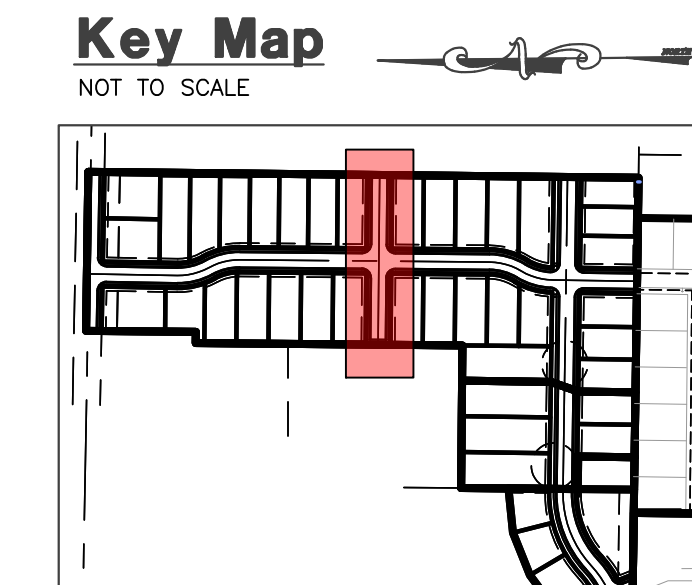
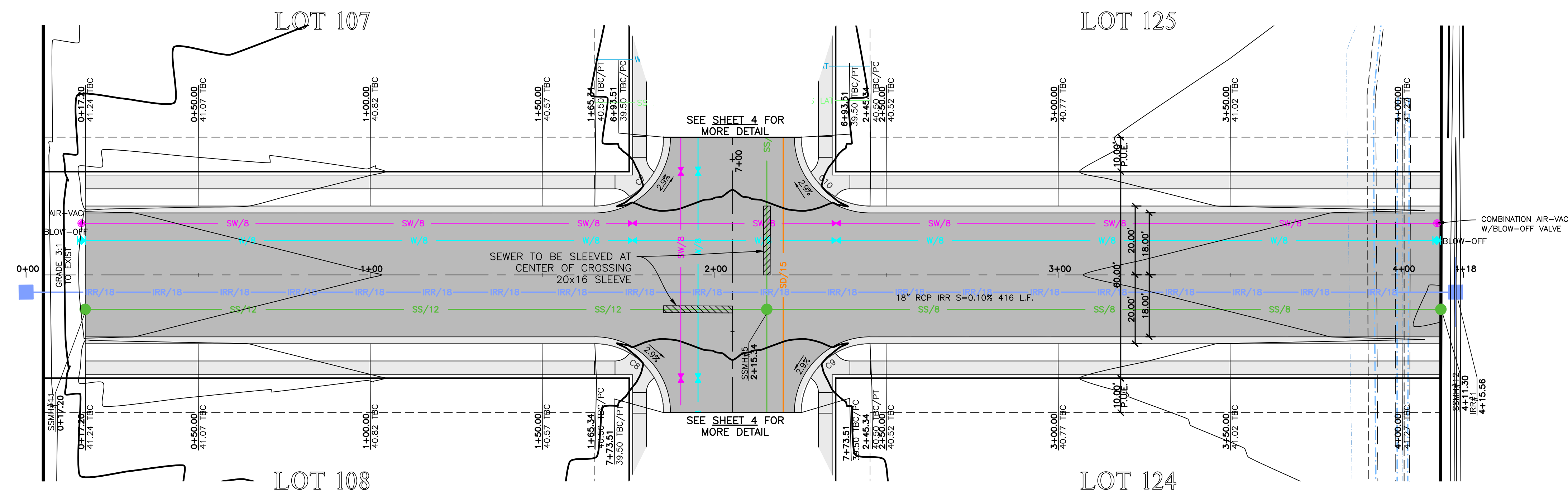

**Construction Notes:**

**CULINARY WATER**  
 NOTE: 4" MIN. COVER REQUIRED OVER CW LINES  
 W/8 - 8" PVC C900 DR-18 WATER LINE  
 W - 1" SDR-9 POLY SERVICE LATERAL

**SANITARY SEWER**  
 SS/4 - 4" PVC SDR-35 SERVICE LATERAL  
 SS/8 - 8" PVC SDR-35 SEWER LINE

**STORM DRAIN**  
 SD/12 - 12" RCP CLASS III STORM DRAIN  
 SD/15 - 15" RCP CLASS III STORM DRAIN  
 SD/18 - 18" RCP CLASS III STORM DRAIN

ALL STORM DRAIN STRUCTURES TO HAVE MINIMUM 6" SUMP UNLESS OTHERWISE LISTED.

**SECONDARY WATER**  
 SW/8 - 8" PVC C-900 DR-14 SECONDARY WATER LINE  
 SW/12 - 12" PVC C-900 DR-14 SECONDARY WATER LINE  
 SW - SECONDARY SERVICE LATERAL PER COUNTY STANDARDS

**IRRIGATION WATER**  
 IRR/18 - 18" RCP CLASS III IRRIGATION PIPE

**Reeve & Associates, Inc.**  
 5160 SOUTH 1500 WEST, RIVERDALE, UTAH 84405  
 TEL: (801) 621-3100 www.reeve.co

**LAND PLANNERS • CIVIL ENGINEERS • LAND SURVEYORS**  
**TRAFFIC ENGINEERS • STRUCTURAL ENGINEERS • LANDSCAPE ARCHITECTS**

REVISIONS	DATE	DESCRIPTION
	08.01.2023	NE County Comments
	08.07.2023	NE Irr. & Wtr. Comm.
	12.13.2023	NE Utility Outfall

**1500 South 0+00.00 - 4+16.00**

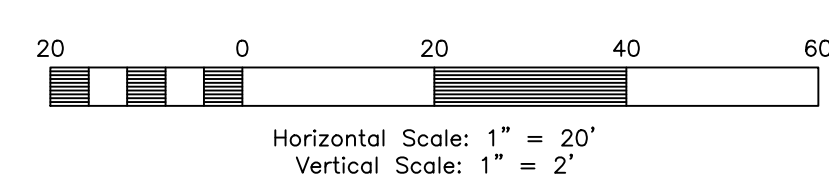

**TBC Curve Data**

#	Delta	Radius	Length	Tangent	Chord	CH Length
C7	90°00'00"	20.00'	31.42'	20.00'	N45°30'47"E	28.28'
C8	90°00'00"	20.00'	31.42'	20.00'	N44°29'13"W	28.28'
C9	90°00'00"	20.00'	31.42'	20.00'	S45°30'47"W	28.28'
C10	90°00'00"	20.00'	31.42'	20.00'	S44°29'13"E	28.28'

- NOTE:**
- ALL CONSTRUCTION IS TO CONFORM TO THE COUNTY STANDARD DRAWINGS AND SPECIFICATIONS.
  - CONSTRUCT HANDICAP RAMP PER ADA AND COUNTY REQUIREMENTS.
  - PROVIDE 18" VERTICAL CLEARANCE FOR WATER OVER/UNDER SEWER.
  - WHEN STANDARD 18" VERTICAL CLEARANCE CAN NOT BE MAINTAINED FOR WATER LATERALS CROSSING SEWER MAINS, SEWER MAIN MUST BE SLEEVED 20' CENTERED AT CROSSING.
  - WHEN STANDARD 18" VERTICAL CLEARANCE CAN NOT BE MAINTAINED FOR SEWER LATERALS CROSSING WATER MAINS, SEWER LATERAL MUST BE SLEEVED 20' ON CENTER AT CROSSING.
  - DEPTH OF WATER TO BE 4" MIN. BELOW FINISHED GRADE.
  - ALL EXISTING DITCHES THAT ARE BEING FILLED IN, MUST HAVE STRUCTURAL FILL IN ALL RIGHT-OF-WAY AND BUILDING FOOTPRINTS.
  - PVC SLEEVES TO BE INSTALLED UNDER PATHWAY FOR SPRINKLER USE.
  - CONTRACTOR TO INSTALL ALL SLEEVES AS REQUIRED FOR THE RESIDENTIAL DEVELOPMENT.
- MINIMUM SLEEVE SIZE REQUIREMENT:**
- |                         |                                |
|-------------------------|--------------------------------|
| CASING 4" SEWER LATERAL | = 8"x20" CENTERED AT CROSSING  |
| CASING 8" SEWER MAIN    | = 12"x20" CENTERED AT CROSSING |
| CASING 12" SEWER MAIN   | = 16"x20" CENTERED AT CROSSING |
| CASING 8" WATER MAIN    | = 12"x20" CENTERED AT CROSSING |

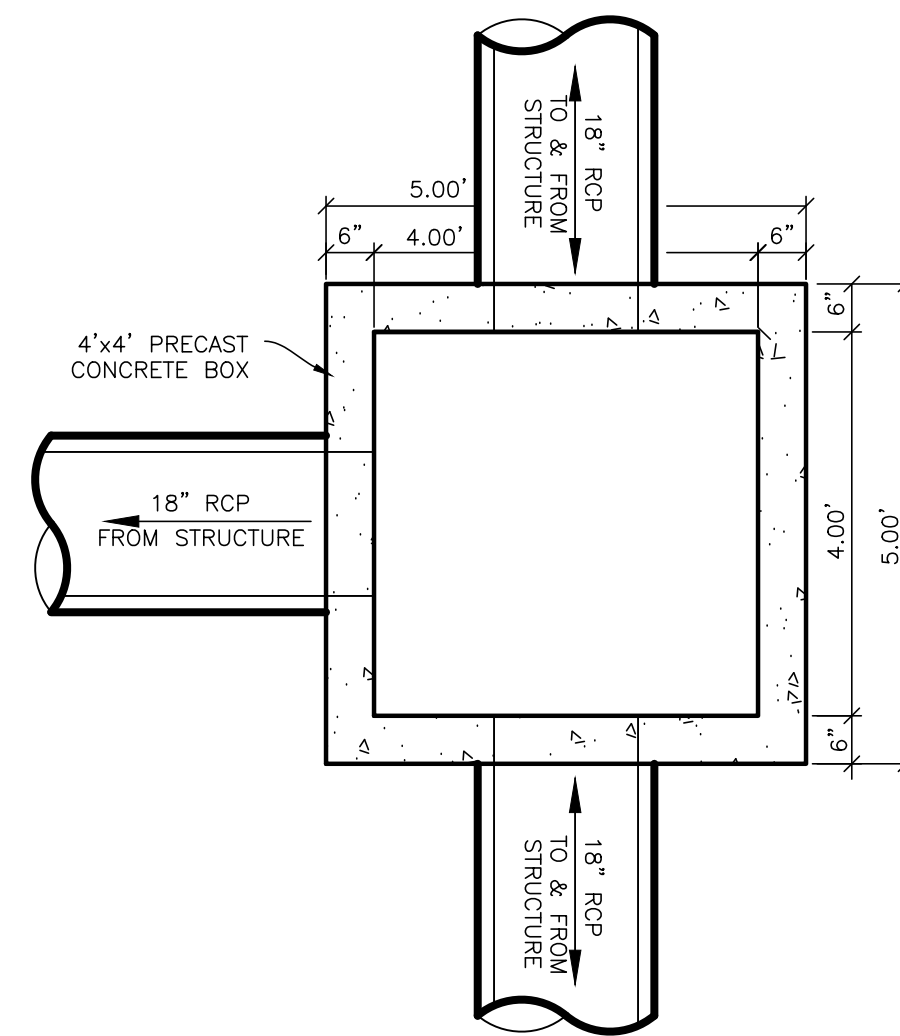
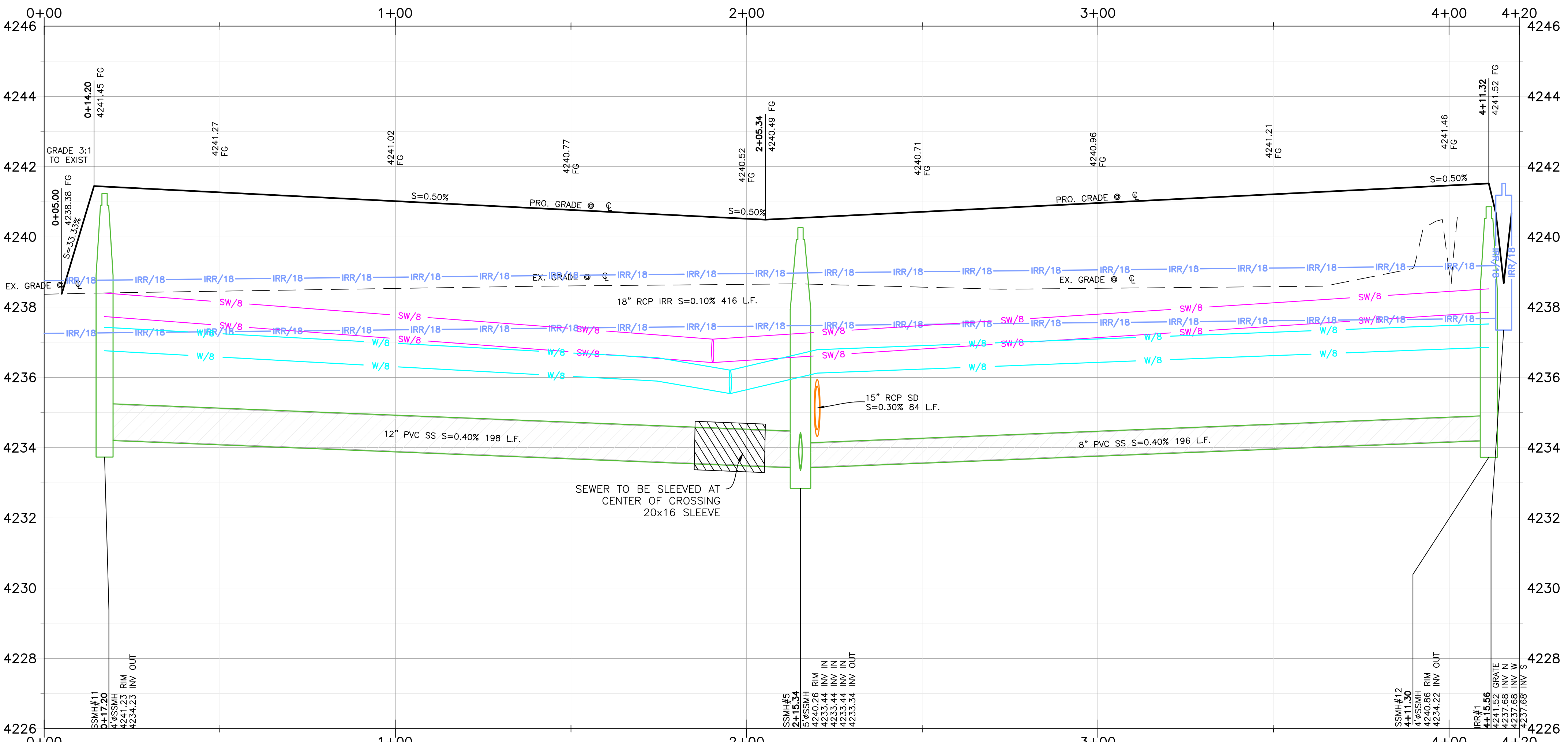

**Irrigation Box Detail**  
 SCALE: NONE

**Anselmi Acres Subdivision**  
 WEBER COUNTY, UTAH

**1500 South 0+00.00 - 4+16.00**



**Project Info.**  
 Engineer: J. NATE REEVE, P.E.  
 Drafter: N. FICKLIN  
 Begin Date: MAY, 2023  
 Name: ANSELMI ACRES SUBDIVISION  
 Number: 7152-19



TBC Curve Data						
#	Delta	Radius	Length	Tangent	Chord	CH Length
C20	43°26'52"	270.00'	204.74'	107.58'	S69°06'30"W	199.87'
C21	43°26'52"	230.00'	174.41'	91.64'	N69°06'30"E	170.26'
C22	14°43'43"	270.00'	69.41'	34.90'	N83°28'04"E	69.22'
C23	82°24'01"	20.00'	28.76'	17.51'	N62°41'46"W	26.35'
C24	81°44'35"	20.00'	28.53'	17.31'	S19°22'32"W	26.17'
C25	12°51'46"	270.00'	60.61'	30.44'	N53°48'56"E	60.49'
C26	43°26'52"	230.00'	174.41'	91.64'	S69°06'30"W	170.26'

Centerline Curve Data						
#	Delta	Radius	Length	Tangent	Chord	CH Length
C5	43°26'52"	250.00'	189.58'	99.61'	N69°06'30"E	185.07'
C6	43°26'52"	250.00'	189.58'	99.61'	N69°06'30"E	185.07'

**NOTE:**

- ALL CONSTRUCTION IS TO CONFORM TO THE COUNTY STANDARD DRAWINGS AND SPECIFICATIONS.
- CONSTRUCT HANDICAP RAMP PER ADA AND COUNTY REQUIREMENTS.
- PROVIDE 18" VERTICAL CLEARANCE FOR WATER OVER/UNDER SEWER.
- WHEN STANDARD 18" VERTICAL CLEARANCE CAN NOT BE MAINTAINED FOR WATER LATERALS CROSSING SEWER MAINS, SEWER MAIN MUST BE SLEEVED 20" CENTERED AT CROSSING.
- WHEN STANDARD 18" VERTICAL CLEARANCE CAN NOT BE MAINTAINED FOR SEWER LATERALS CROSSING WATER MAINS, SEWER LATERAL MUST BE SLEEVED 20" CENTER AT CROSSING.
- DEPTH OF WATER TO BE 4" MIN. BELOW FINISHED GRADE.
- ALL EXISTING DITCHES THAT ARE BEING FILLED IN, MUST HAVE STRUCTURAL FILL IN ALL RIGHT-OF-WAY AND BUILDING FOOTPRINTS.
- PVC SLEEVES TO BE INSTALLED UNDER PATHWAY FOR SPRINKLER USE.
- CONTRACTOR TO INSTALL ALL SLEEVES AS REQUIRED FOR THE RESIDENTIAL DEVELOPMENT.

**MINIMUM SLEEVE SIZE REQUIREMENT:**

- CASING 4" SEWER LATERAL = 8"x20" CENTERED AT CROSSING
- CASING 8" SEWER MAIN = 12"x20" CENTERED AT CROSSING
- CASING 12" SEWER MAIN = 16"x20" CENTERED AT CROSSING
- CASING 8" WATER MAIN = 12"x20" CENTERED AT CROSSING

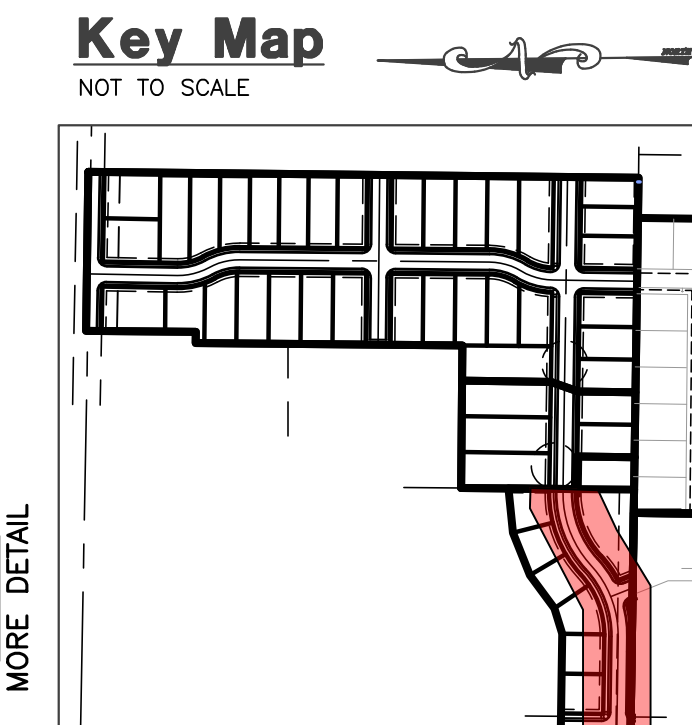

**Construction Notes:**

- CULINARY WATER**  
NOTE: 4" MIN. COVER REQUIRED OVER CW LINES  
W/B - 8" PVC C900 DR-18 WATER LINE  
W - 1" SDR-9 POLY SERVICE LATERAL
- SANITARY SEWER**  
SS/4 - 4" PVC SDR-35 SERVICE LATERAL  
SS/8 - 8" PVC SDR-35 SEWER LINE
- STORM DRAIN**  
SD/12 - 12" RCP CLASS III STORM DRAIN  
SD/15 - 15" RCP CLASS III STORM DRAIN  
SD/18 - 18" RCP CLASS III STORM DRAIN
- SECONDARY WATER**  
SW/8 - 8" PVC C-900 DR-14 SECONDARY WATER LINE  
SW/12 - 12" PVC C-900 DR-14 SECONDARY WATER LINE  
SW - SECONDARY SERVICE LATERAL PER COUNTY STANDARDS
- IRRIGATION WATER**  
IRR/18 - 18" RCP CLASS III IRRIGATION PIPE

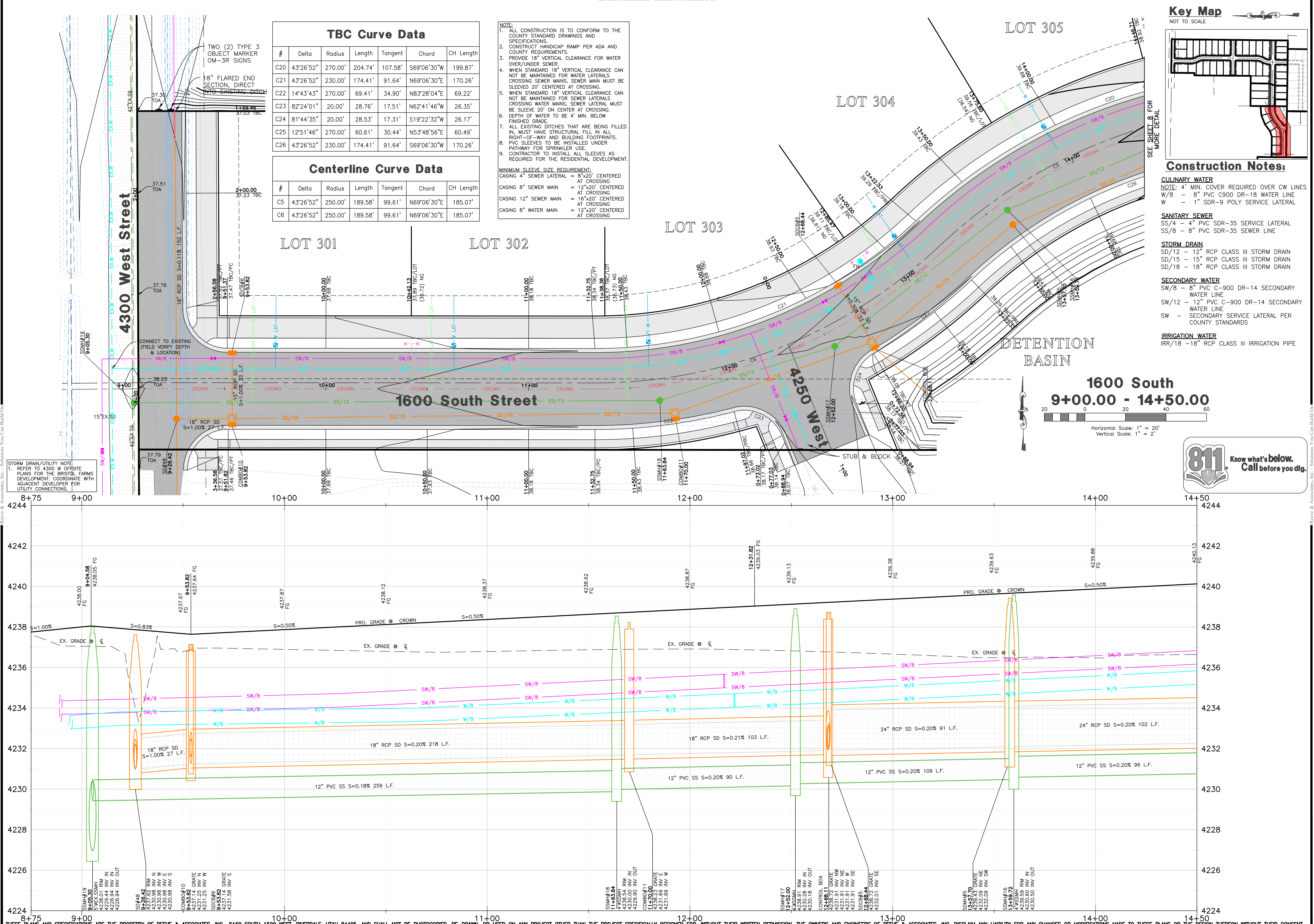

**Reeve & Associates, Inc.**  
1510 SOUTH 1500 WEST, RIVERDALE, UTAH 84405  
TEL: (801) 621-3100 www.reeve.co

**RA**

LAND PLANNERS • CIVIL ENGINEERS • LAND SURVEYORS  
TRAFFIC ENGINEERS • STRUCTURAL ENGINEERS • LANDSCAPE ARCHITECTS

DATE	DESCRIPTION
08.01.2023	NE County Comments
08.07.2023	NE Irr. & Wtr. Comm.
12.13.2023	NE Utility Outfall

**Anselmi Acres Subdivision**  
WEBER COUNTY, UTAH

**1600 South 9+00.00 - 14+50.00**



**Project Info.**

Engineer: J. NATE REEVE, P.E.  
 Drafter: N. FICKLIN  
 Begin Date: MAY, 2023  
 Name: ANSELMI ACRES SUBDIVISION  
 Number: 7152-19

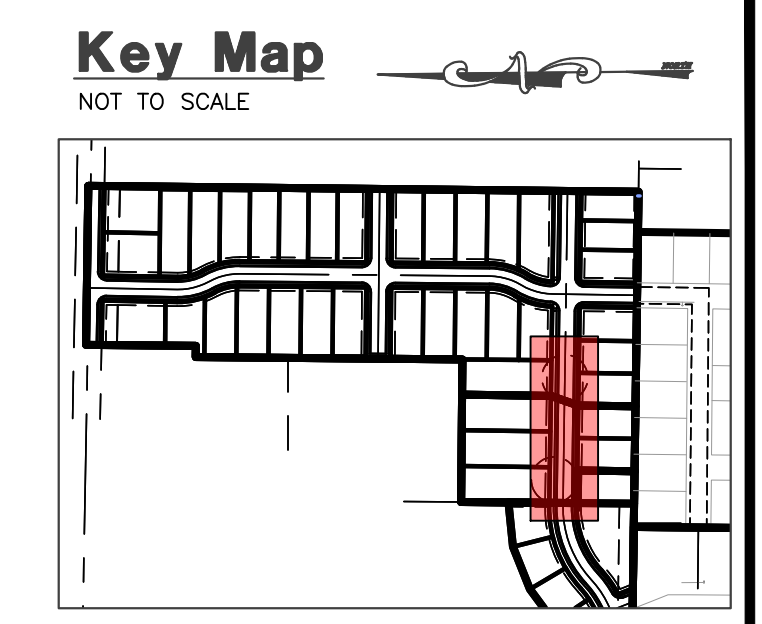
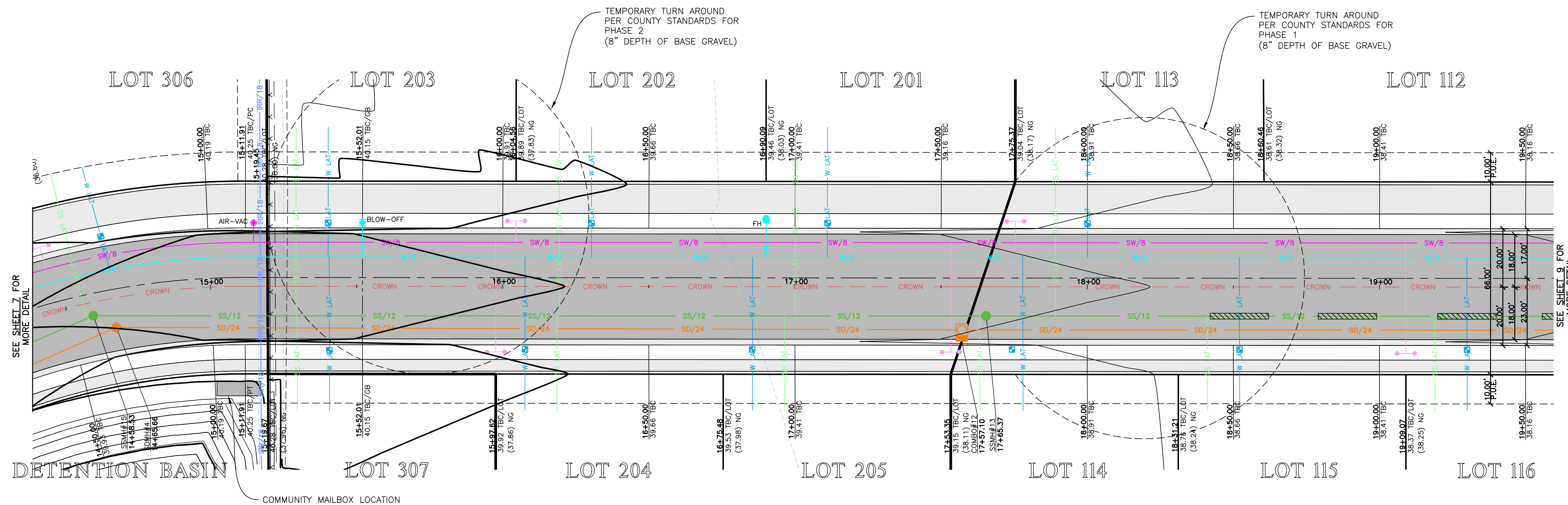

- Construction Notes:**
- CULINARY WATER**  
 NOTE: 4" MIN. COVER REQUIRED OVER CW LINES  
 W/8 - 8" PVC C900 DR-18 WATER LINE  
 W - 1" SDR-9 POLY SERVICE LATERAL
- SANITARY SEWER**  
 SS/4 - 4" PVC SDR-35 SERVICE LATERAL  
 SS/8 - 8" PVC SDR-35 SEWER LINE
- STORM DRAIN**  
 SD/12 - 12" RCP CLASS III STORM DRAIN  
 SD/15 - 15" RCP CLASS III STORM DRAIN  
 SD/18 - 18" RCP CLASS III STORM DRAIN
- ALL STORM DRAIN STRUCTURES TO HAVE MINIMUM 6" SUMP UNLESS OTHERWISE LISTED.
- SECONDARY WATER**  
 SW/8 - 8" PVC C-900 DR-14 SECONDARY WATER LINE  
 SW/12 - 12" PVC C-900 DR-14 SECONDARY WATER LINE  
 SW - SECONDARY SERVICE LATERAL PER COUNTY STANDARDS
- IRRIGATION WATER**  
 IRR/18 - 18" RCP CLASS III IRRIGATION PIPE

- NOTE:**
- ALL CONSTRUCTION IS TO CONFORM TO THE COUNTY STANDARD DRAWINGS AND SPECIFICATIONS.
  - CONSTRUCT HANDICAP RAMP PER ADA AND COUNTY REQUIREMENTS.
  - PROVIDE 18" VERTICAL CLEARANCE FOR WATER OVER/UNDER SEWER.
  - WHEN STANDARD 18" VERTICAL CLEARANCE CAN NOT BE MAINTAINED FOR WATER LATERALS CROSSING SEWER MAINS, SEWER MAIN MUST BE SLEEVED 20' CENTERED AT CROSSING.
  - WHEN STANDARD 18" VERTICAL CLEARANCE CAN NOT BE MAINTAINED FOR SEWER LATERALS CROSSING WATER MAINS, SEWER LATERAL MUST BE SLEEVED 20' ON CENTER AT CROSSING.
  - DEPTH OF WATER TO BE 4" MIN. BELOW FINISHED GRADE.
  - ALL EXISTING DITCHES THAT ARE BEING FILLED IN, MUST HAVE STRUCTURAL FILL IN ALL RIGHT-OF-WAY AND BUILDING FOOTPRINTS. PVC SLEEVES TO BE INSTALLED UNDER PATHWAY FOR SPRINKLER USE.
  - CONTRACTOR TO INSTALL ALL SLEEVES AS REQUIRED FOR THE RESIDENTIAL DEVELOPMENT.
- MINIMUM SLEEVE SIZE REQUIREMENT:**  
 CASING 4" SEWER LATERAL = 8"x20' CENTERED AT CROSSING  
 CASING 8" SEWER MAIN = 12"x20' CENTERED AT CROSSING  
 CASING 12" SEWER MAIN = 16"x20' CENTERED AT CROSSING  
 CASING 8" WATER MAIN = 12"x20' CENTERED AT CROSSING

**1575 South 14+50.00 - 19+50.00**

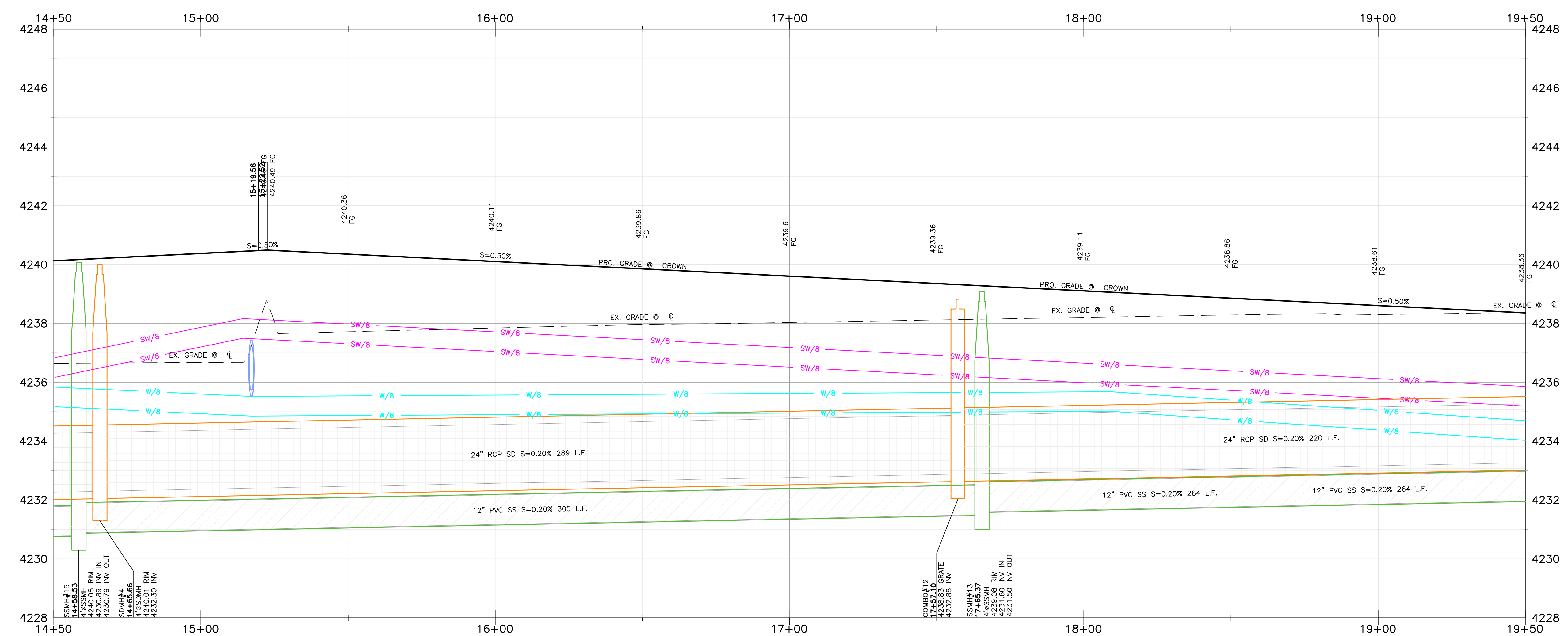
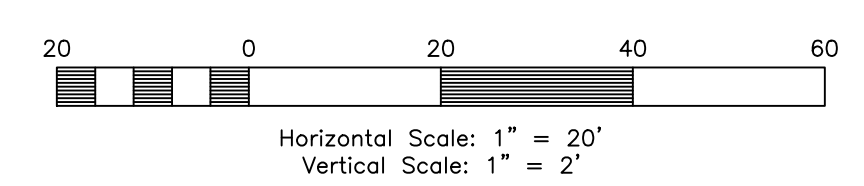

**Reeve & Associates, Inc.**  
 5160 SOUTH 1500 WEST, RIVERDALE, UTAH 84405  
 LAND PLANNERS • CIVIL ENGINEERS • LAND SURVEYORS  
 TRAFFIC ENGINEERS • STRUCTURAL ENGINEERS • LANDSCAPE ARCHITECTS

REVISIONS	DATE	DESCRIPTION
	08.01.2023	NE County Comments
	08.07.2023	NE Irr. & Wtr. Comm.
	12.13.2023	NE Utility Outfall

**Anselmi Acres Subdivision**  
 WEBER COUNTY, UTAH

**1575 South 14+50.00 - 19+50.00**



**Project Info.**

Engineer: J. NATE REEVE, P.E.  
 Drafter: N. FICKLIN  
 Begin Date: MAY, 2023  
 Name: ANSELMI ACRES SUBDIVISION  
 Number: 7152-19

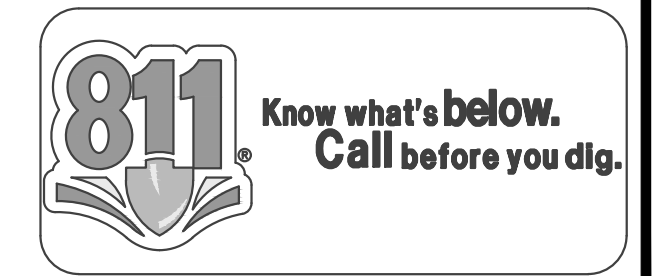



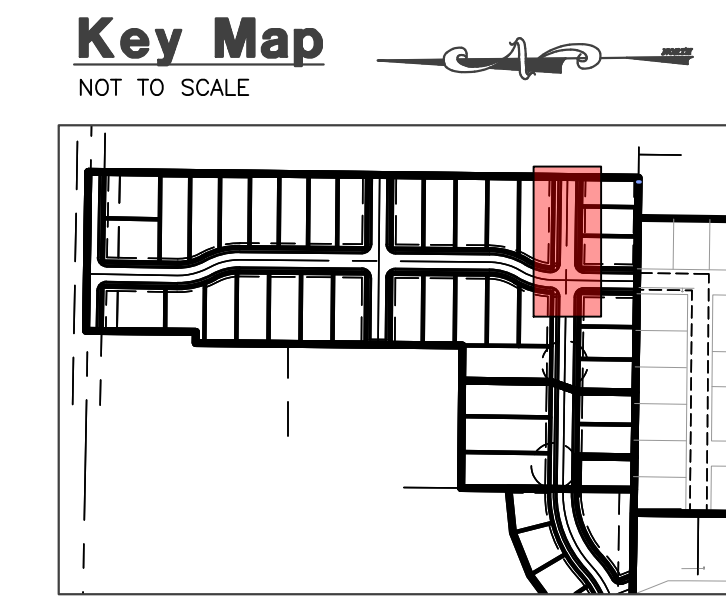
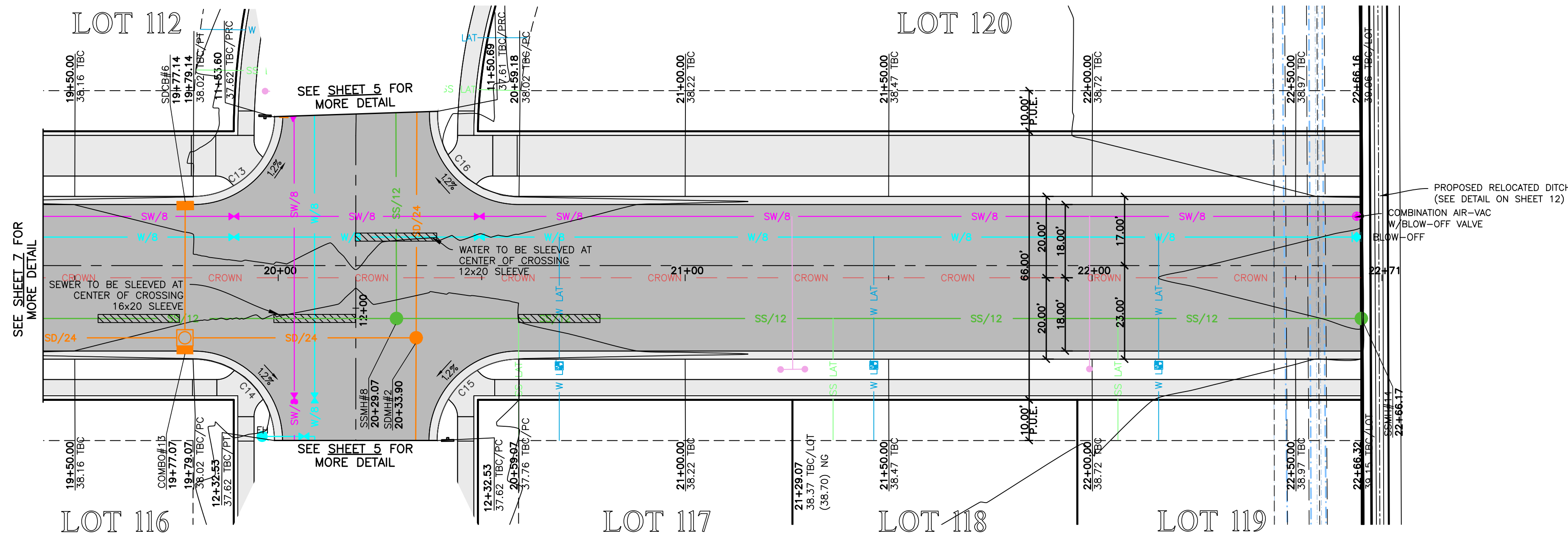

**Construction Notes:**

- CULINARY WATER**  
 NOTE: 4" MIN. COVER REQUIRED OVER CW LINES  
 W/8 - 8" PVC C900 DR-18 WATER LINE  
 W - 1" SDR-9 POLY SERVICE LATERAL
- SANITARY SEWER**  
 SS/4 - 4" PVC SDR-35 SERVICE LATERAL  
 SS/8 - 8" PVC SDR-35 SEWER LINE
- STORM DRAIN**  
 SD/12 - 12" RCP CLASS III STORM DRAIN  
 SD/15 - 15" RCP CLASS III STORM DRAIN  
 SD/18 - 18" RCP CLASS III STORM DRAIN
- ALL STORM DRAIN STRUCTURES TO HAVE MINIMUM 6" SUMP UNLESS OTHERWISE LISTED.
- SECONDARY WATER**  
 SW/8 - 8" PVC C-900 DR-14 SECONDARY WATER LINE  
 SW/12 - 12" PVC C-900 DR-14 SECONDARY WATER LINE  
 SW - SECONDARY SERVICE LATERAL PER COUNTY STANDARDS
- IRRIGATION WATER**  
 IRR/18 - 18" RCP CLASS III IRRIGATION PIPE

- NOTE:**
- ALL CONSTRUCTION IS TO CONFORM TO THE COUNTY STANDARD DRAWINGS AND SPECIFICATIONS.
  - CONSTRUCT HANDICAP RAMP PER ADA AND COUNTY REQUIREMENTS.
  - PROVIDE 18" VERTICAL CLEARANCE FOR WATER OVER/UNDER SEWER.
  - WHEN STANDARD 18" VERTICAL CLEARANCE CAN NOT BE MAINTAINED FOR WATER LATERALS CROSSING SEWER MAINS, SEWER MAIN MUST BE SLEEVED 20' CENTERED AT CROSSING.
  - WHEN STANDARD 18" VERTICAL CLEARANCE CAN NOT BE MAINTAINED FOR SEWER LATERALS CROSSING WATER MAINS, SEWER LATERAL MUST BE SLEEVED 20' ON CENTER AT CROSSING.
  - DEPTH OF WATER TO BE 4" MIN. BELOW FINISHED GRADE.
  - ALL EXISTING DITCHES THAT ARE BEING FILLED IN, MUST HAVE STRUCTURAL FILL IN ALL RIGHT-OF-WAY AND BUILDING FOOTPRINTS.
  - PVC SLEEVES TO BE INSTALLED UNDER PATHWAY FOR SPRINKLER USE.
  - CONTRACTOR TO INSTALL ALL SLEEVES AS REQUIRED FOR THE RESIDENTIAL DEVELOPMENT.
- MINIMUM SLEEVE SIZE REQUIREMENT:**
- |                         |                                |
|-------------------------|--------------------------------|
| CASING 4" SEWER LATERAL | = 8"x20' CENTERED AT CROSSING  |
| CASING 8" SEWER MAIN    | = 12"x20' CENTERED AT CROSSING |
| CASING 12" SEWER MAIN   | = 16"x20' CENTERED AT CROSSING |
| CASING 8" WATER MAIN    | = 12"x20' CENTERED AT CROSSING |

**1575 South 19+50.00 - 22+71.00**

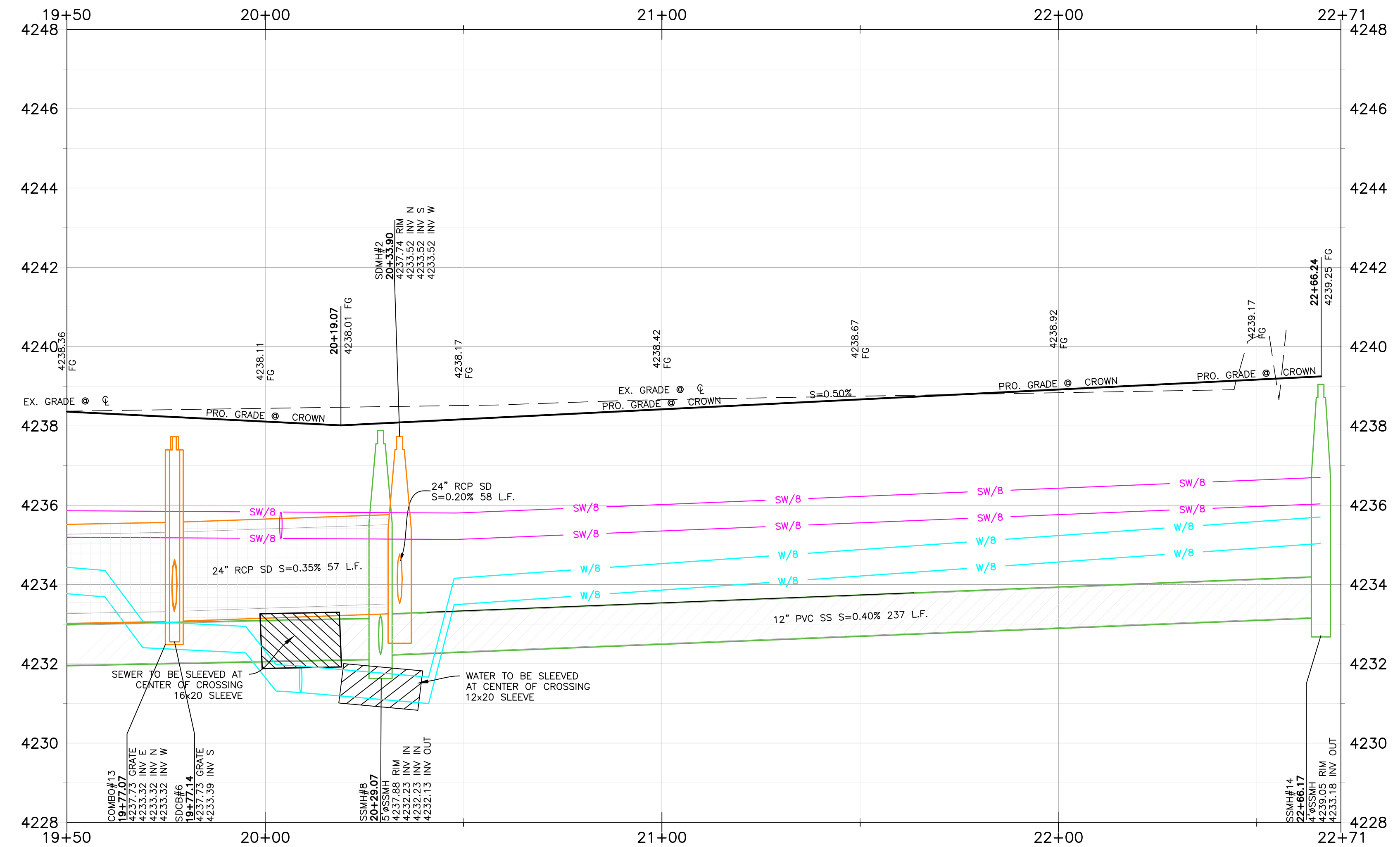
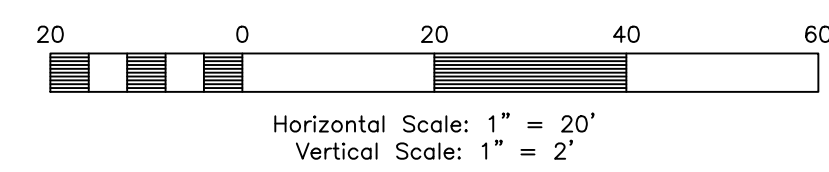

**Reeve & Associates, Inc.**  
 5160 SOUTH 1500 WEST, RIVERDALE, UTAH 84405  
 TEL: (801) 621-3100 www.reeve.co

**LAND PLANNERS • CIVIL ENGINEERS • LAND SURVEYORS**  
**TRAFFIC ENGINEERS • STRUCTURAL ENGINEERS • LANDSCAPE ARCHITECTS**

REVISIONS	DESCRIPTION
DATE	COUNTY COMMENTS
08.01.2023	NE Irr. & Wtr. Comm.
08.07.2023	NE Irr. & Wtr. Comm.
12.13.2023	NE Irr. & Wtr. Comm.

**Anselmi Acres Subdivision**  
 WEBER COUNTY, UTAH

**1575 South 19+50.00 - 22+71.00**



**Project Info.**

Engineer: J. NATE REEVE, P.E.  
 Drafter: N. FICKLIN  
 Begin Date: MAY, 2023  
 Name: ANSELMI ACRES SUBDIVISION  
 Number: 7152-19



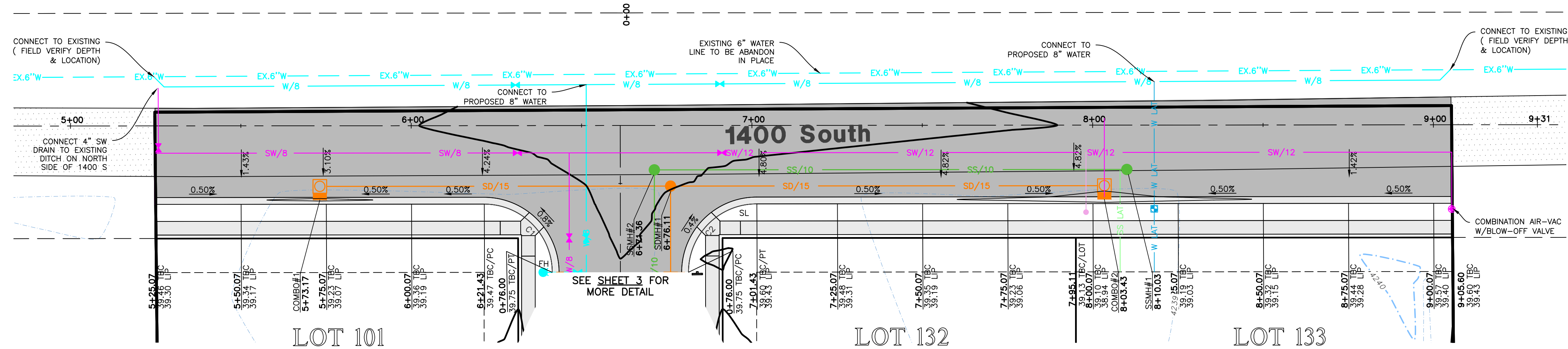

**1400 SOUTH NOTES:**  
 1. SAWCUT EXISTING ASPHALT FOR TACK SEAL OF NEW ASPHALT ON FULL ROAD WIDTH.  
 2. CONTRACTOR TO VERIFY 2% MINIMUM-5% MAX SLOPE.  
 3. SLOPE SHALL FLOW TOWARDS CURB & GUTTER UNLESS SPECIFIED DIFFERENT ON PLAN.  
 4. ASPHALT SEAL COAT FOR ASPHALT PRESERVATION TO BE COORDINATED WITH COUNTY.

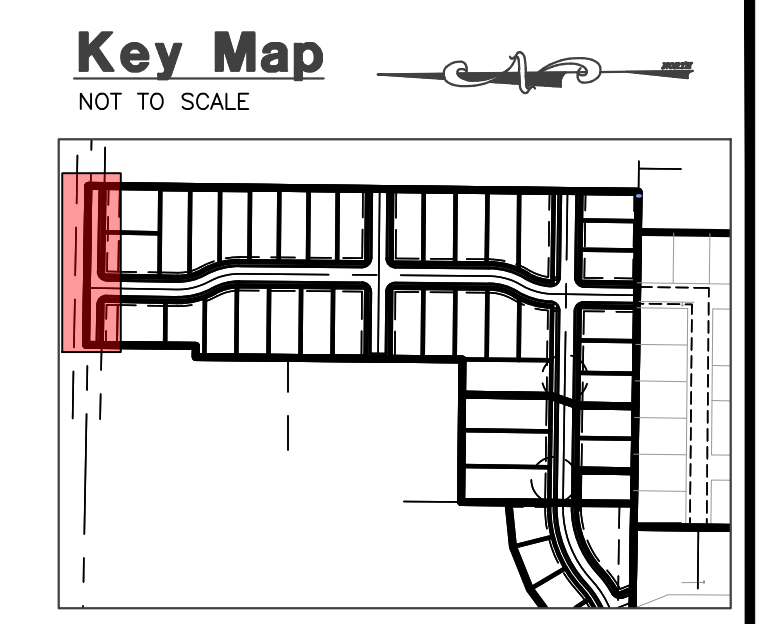
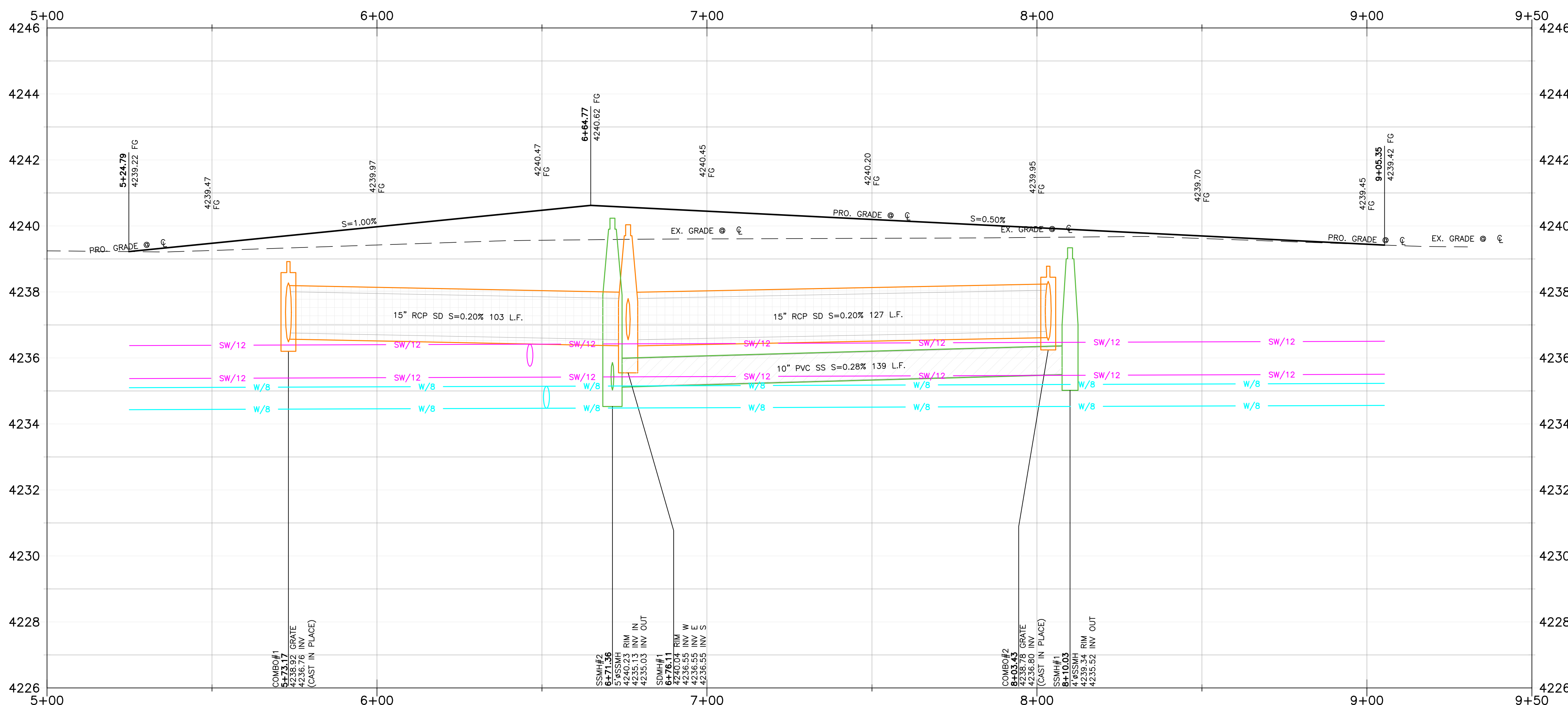
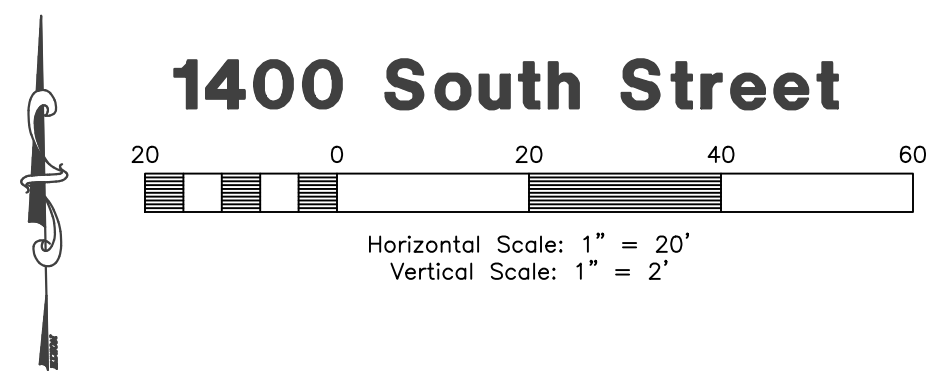

**Construction Notes:**

**CULINARY WATER**  
 NOTE: 4" MIN. COVER REQUIRED OVER CW LINES  
 W/8 - 8" PVC C900 DR-18 WATER LINE  
 W - 1" SDR-9 POLY SERVICE LATERAL

**SANITARY SEWER**  
 SS/4 - 4" PVC SDR-35 SERVICE LATERAL  
 SS/8 - 8" PVC SDR-35 SEWER LINE

**STORM DRAIN**  
 SD/12 - 12" RCP CLASS III STORM DRAIN  
 SD/15 - 15" RCP CLASS III STORM DRAIN  
 SD/18 - 18" RCP CLASS III STORM DRAIN

ALL STORM DRAIN STRUCTURES TO HAVE MINIMUM 6" SUMP UNLESS OTHERWISE LISTED.

**SECONDARY WATER**  
 SW/8 - 8" PVC C-900 DR-14 SECONDARY WATER LINE  
 SW/12 - 12" PVC C-900 DR-14 SECONDARY WATER LINE  
 SW - SECONDARY SERVICE LATERAL PER COUNTY STANDARDS

**IRRIGATION WATER**  
 IRR/18 - 18" RCP CLASS III IRRIGATION PIPE

**NOTE:**

- ALL CONSTRUCTION IS TO CONFORM TO THE COUNTY STANDARD DRAWINGS AND SPECIFICATIONS.
- CONSTRUCT HANDICAP RAMP PER ADA AND COUNTY REQUIREMENTS.
- PROVIDE 18" VERTICAL CLEARANCE FOR WATER OVER/UNDER SEWER.
- WHEN STANDARD 18" VERTICAL CLEARANCE CAN NOT BE MAINTAINED FOR WATER LATERALS CROSSING SEWER MAINS, SEWER MAIN MUST BE SLEEVED 20' CENTERED AT CROSSING.
- WHEN STANDARD 18" VERTICAL CLEARANCE CAN NOT BE MAINTAINED FOR SEWER LATERALS CROSSING WATER MAINS, SEWER LATERAL MUST BE SLEEVED 20' ON CENTER AT CROSSING.
- DEPTH OF WATER TO BE 4" MIN. BELOW FINISHED GRADE.
- ALL EXISTING DITCHES THAT ARE BEING FILLED IN, MUST HAVE STRUCTURAL FILL IN ALL RIGHT-OF-WAY AND BUILDING FOOTPRINTS.
- PVC SLEEVES TO BE INSTALLED UNDER PATHWAY FOR SPRINKLER USE.
- CONTRACTOR TO INSTALL ALL SLEEVES AS REQUIRED FOR THE RESIDENTIAL DEVELOPMENT.

**MINIMUM SLEEVE SIZE REQUIREMENT:**  
 CASING 4" SEWER LATERAL = 8"x20' CENTERED AT CROSSING  
 CASING 8" SEWER MAIN = 12"x20' CENTERED AT CROSSING  
 CASING 12" SEWER MAIN = 16"x20' CENTERED AT CROSSING  
 CASING 8" WATER MAIN = 12"x20' CENTERED AT CROSSING

**Reeve & Associates, Inc.**  
 5160 SOUTH 1500 WEST, RIVERDALE, UTAH 84405  
 TEL: (801) 621-3100 www.reeve.co

**RA**

LAND PLANNERS • CIVIL ENGINEERS • LAND SURVEYORS  
 TRAFFIC ENGINEERS • STRUCTURAL ENGINEERS • LANDSCAPE ARCHITECTS

REVISIONS	DATE	DESCRIPTION
	08.01.2023	NE County Comments
	08.07.2023	NE Irr. & Wtr. Comm.
	12.13.2023	NE Utility Outfall

**Anselmi Acres Subdivision**  
 WEBER COUNTY, UTAH

**1400 South 5+00.00 - 9+50.00**



**Project Info.**  
 Engineer: J. NATE REEVE, P.E.  
 Drafter: N. FICKLIN  
 Begin Date: MAY, 2023  
 Name: ANSELMI ACRES SUBDIVISION  
 Number: 7152-19



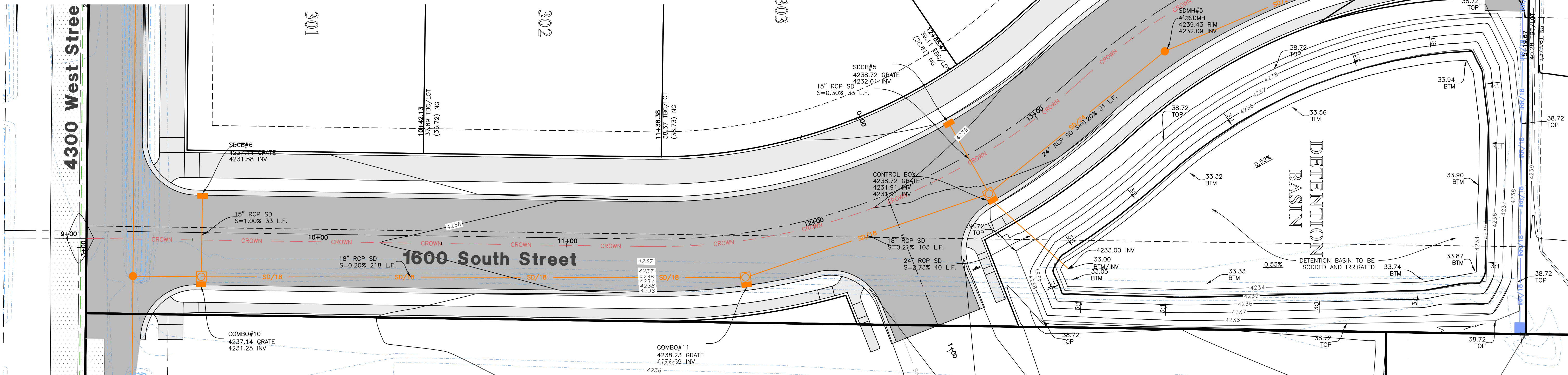
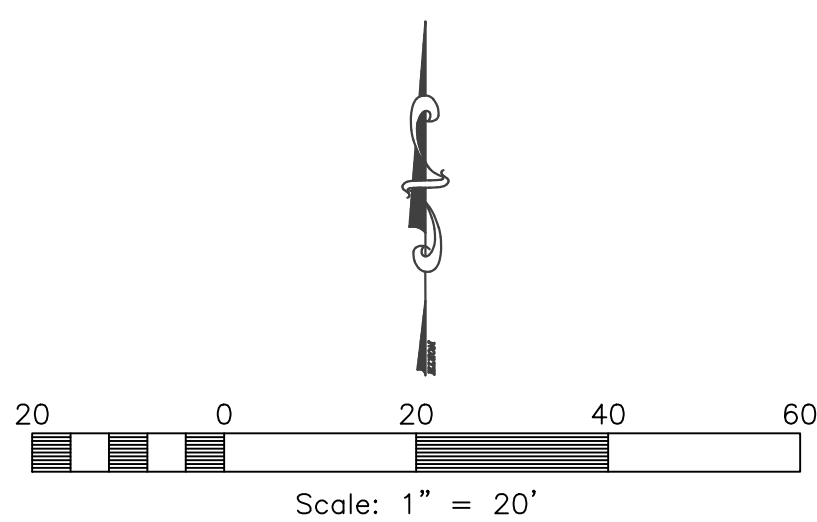

**Storm Runoff Calculations**  
Anselmi  
7152-19

8/1/2023  
2/8/2024

The following runoff calculations are based on the Rainfall - Intensity - Duration Frequency Curve for the West Weber City area taken from the NOAA Atlas 14 database. Calculations have been completed for the 100-yr 24-hr storm event. Storm water runoff has been calculated for a fully developed site and limited to a release rate of 0.1 cfs/acre.

The calculations are as follows:

<b>Drainage Area:</b>	Total Area = 18.23 acre or 794,069 ft <sup>2</sup>
<b>Runoff Coefficients:</b>	20% Paved Area 0.90 11% Roof 0.90 78% Landscaped Area 0.18
<b>LID Retention:</b>	30% Percentils Rainfall Event is the site Feasible for LID? No Site Imperviousness 0.31 NRCS Soil Group CID Rv Equation 0.82*1.122 Rv 0.22 V <sub>rain</sub> 8,930 c.f.
<b>Rainfall Intensities:</b>	10-yr intensity for a 30 minute TOC - Pipe Capacity 1.39 in/hr
<b>Peak Run-off:</b>	Runoff Coefficient C = 0.40 Rainfall Intensity I = 1.39 IN./HR. Acreage A = 19.85 ACRES Q = 11.06 cfs
<b>Volume of Run-off for 100-year Storm Event:</b>	C = 0.40 I = 1.39 IN./HR. A = 19.85 ACRES Q = 11.06 cfs

time (min)	time (sec)	i (in./hr)	Q (cfs)	Vol. in (cf)	Vol. out (cf)	Difference (cf)
0	0	0.00	0	0	0	0
5	300	6.59	48.54	14562	547	14015
10	600	5.00	36.83	22097	1094	21004
15	900	4.14	30.49	27445	1641	25804
30	1800	2.79	20.55	36991	3291	33700
60	3600	1.72	12.67	45609	6583	39027
120	7200	0.94	6.95	50094	13125	36969
180	10800	0.64	4.73	51072	19888	31184
360	21600	0.36	2.64	56958	39375	17583
720	43200	0.22	1.62	70005	78751	-8746
1440	86400	0.12	0.91	78914	157501	-78587

**Orifice Sizing:**

Given: Q = 1.82 cfs  
2g = 64.4 ft/s<sup>2</sup>  
H = 5.81 ft  
Cd = 0.62  
R = SQRT(Q/(0.7\*(64.4\*H)<sup>0.5</sup>))  
R = 0.22 feet  
D = 2.64 inches  
A = 5.28 inches \* 2 = 0.1521 ft \* 2

**SUMMARY:**  
The required 100-yr storage volume is 39,047 cubic feet  
The required LID Retention volume is Not Feasible cubic feet  
Orifice size is 5.3 inches

**DETECTION BASIN - STAGE STORAGE TABLE**

ELEV.	AREA (sq. ft.)	DEPTH (ft)	CONIC INC. VOL. (cu. ft.)	CONIC TOTAL VOL. (cu. ft.)
4,233.00	0	N/A	N/A	0
4,234.00	10,159	1.00	3390	3390
4,235.00	11,655	1.00	10898	14289
4,236.00	13,231	1.00	12435	26724
4,237.00	14,885	1.00	14050	40774
4,237.72	16,124	0.72	11160	51935
4,238.00	16,617	0.28	4583	56519
4,238.72	17,934	0.72	12435	68954

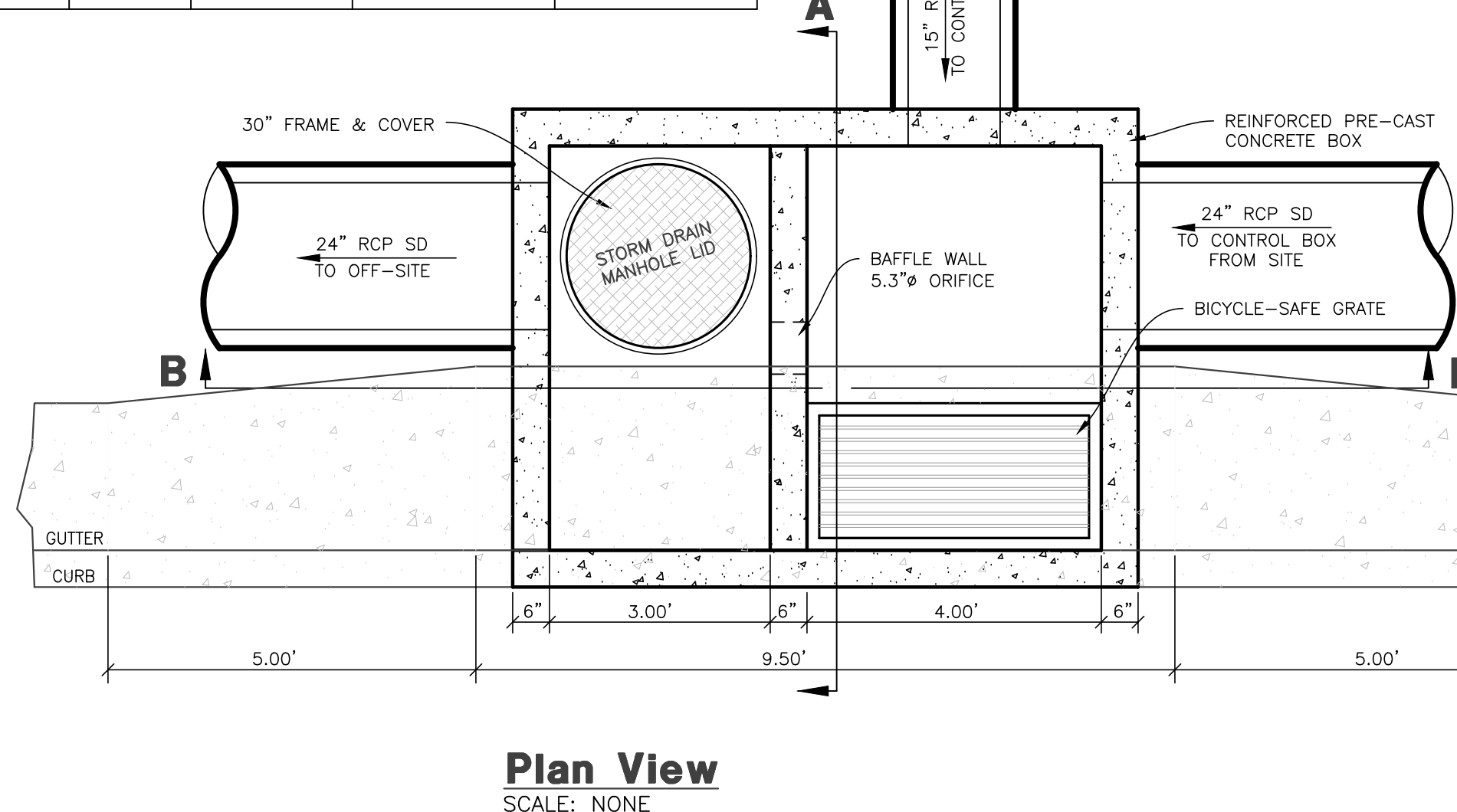

**Plan View**  
SCALE: NONE

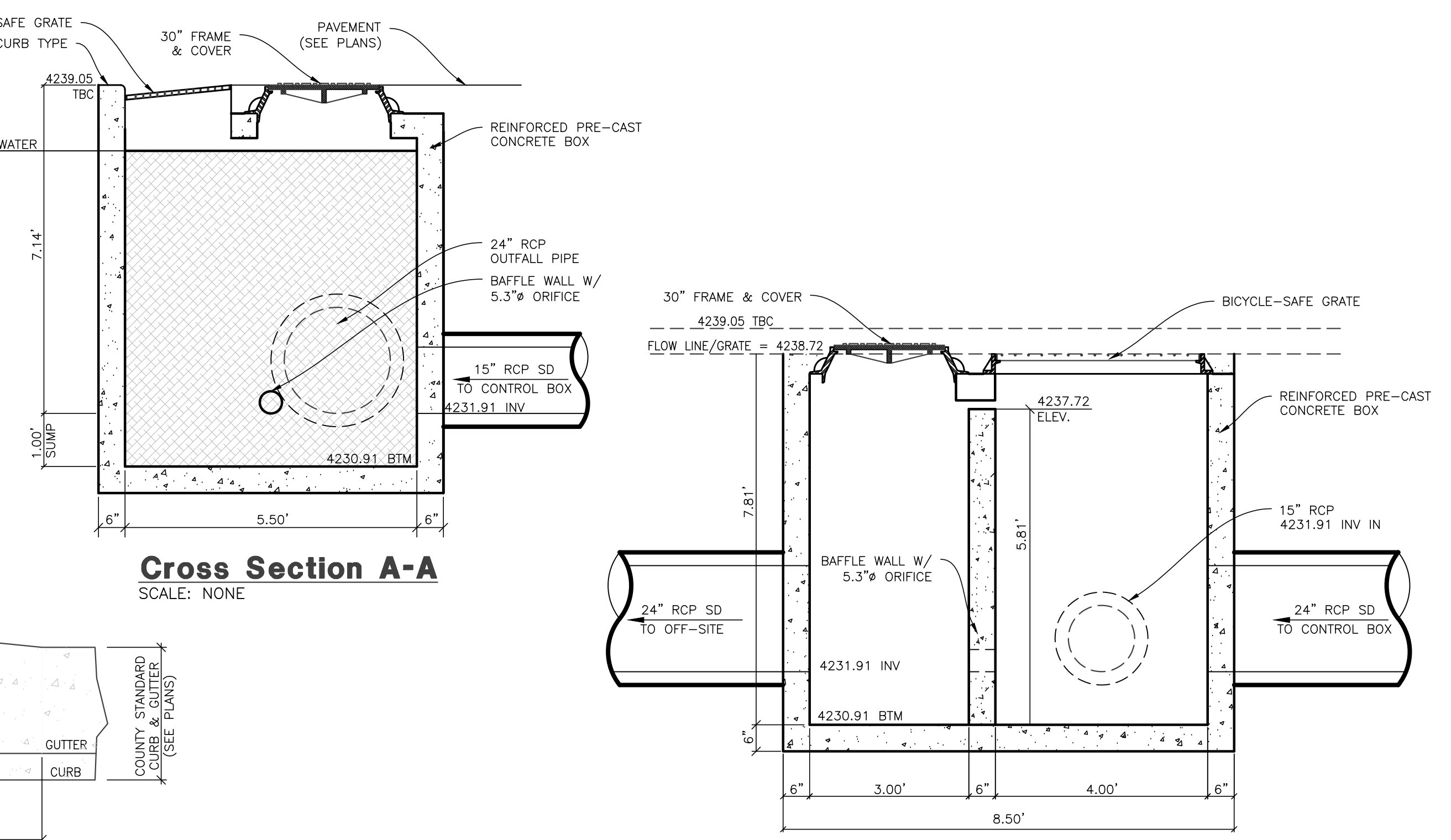

**Cross Section A-A**  
SCALE: NONE

**Cross Section B-B**  
SCALE: NONE

**Control Box/ Combo Box**  
SCALE: NONE

**Notice:**  
THESE PLANS WERE CREATED UTILIZING COLORS FOR UTILITIES & OTHER INFRASTRUCTURE. IF PRINTED IN, OR COPIED TO BLACK & WHITE, SOME LINE WORK MAY NOT SHOW UP PROPERLY.

**Reeve & Associates, Inc.**  
5160 SOUTH 1500 WEST, RIVERDALE, UTAH 84405  
TEL: (801) 621-3100 www.reeve.co

**RA**

LAND PLANNERS • CIVIL ENGINEERS • LAND SURVEYORS  
TRAFFIC ENGINEERS • STRUCTURAL ENGINEERS • LANDSCAPE ARCHITECTS

**REVISIONS**

DATE	DESCRIPTION
08.01.2023	NE County Comments
08.07.2023	NE Irr. & Wtr. Comm.
12.13.2023	NE Utility Outfall

**Anselmi Acres Subdivision**  
WEBER COUNTY, UTAH

**Basin Detail**



**Project Info.**  
Engineer: J. NATE REEVE, P.E.  
 Drafter: N. FICKLIN  
Begin Date: MAY, 2023  
Name: ANSELMI ACRES SUBDIVISION  
Number: 7152-19

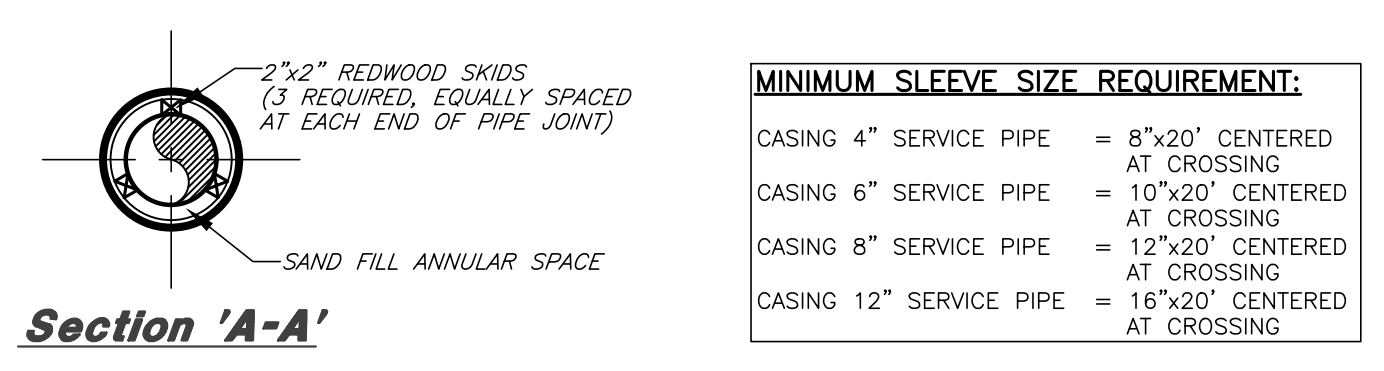
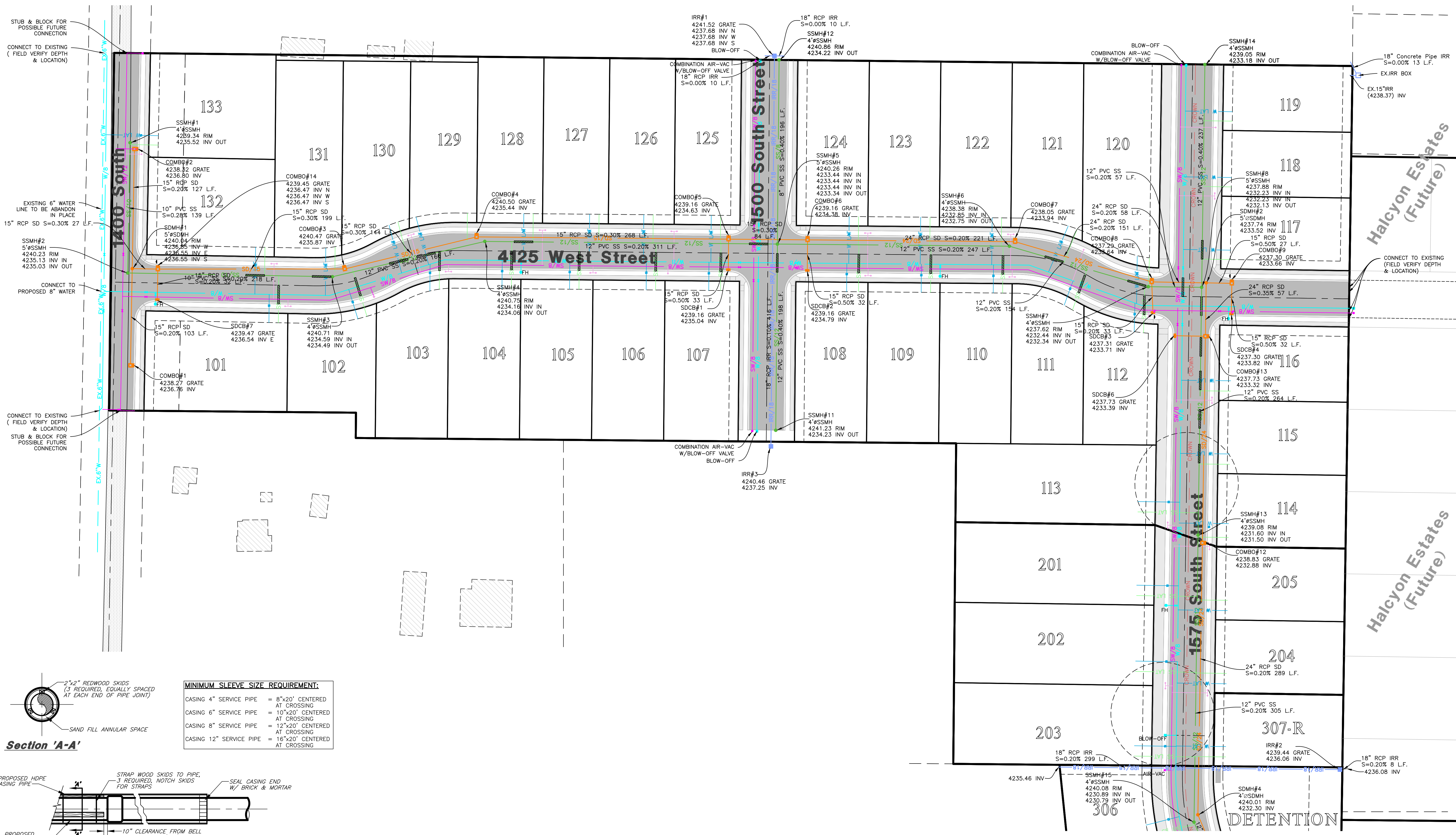

**MINIMUM SLEEVE SIZE REQUIREMENT:**

CASING 4" SERVICE PIPE	= 8"x20" CENTERED AT CROSSING
CASING 6" SERVICE PIPE	= 10"x20" CENTERED AT CROSSING
CASING 8" SERVICE PIPE	= 12"x20" CENTERED AT CROSSING
CASING 12" SERVICE PIPE	= 18"x20" CENTERED AT CROSSING

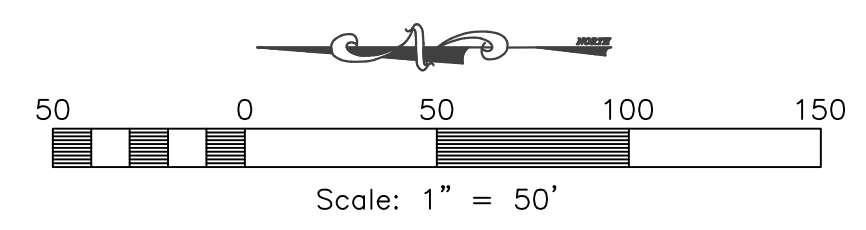
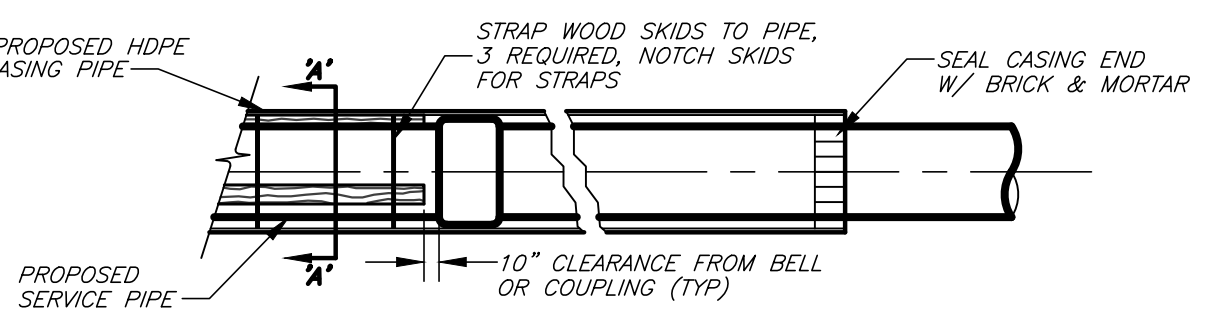

**Notice:**  
THESE PLANS WERE CREATED UTILIZING COLORS FOR UTILITIES & OTHER INFRASTRUCTURE. IF PRINTED IN, OR COPIED TO BLACK & WHITE, SOME LINE WORK MAY NOT SHOW UP PROPERLY.

**Reeve & Associates, Inc.**  
5160 SOUTH 1500 WEST, RIVERDALE, UTAH 84405  
TEL: (801) 621-3100 www.reeve.co

**RA**

LAND PLANNERS • CIVIL ENGINEERS • LAND SURVEYORS  
TRAFFIC ENGINEERS • STRUCTURAL ENGINEERS • LANDSCAPE ARCHITECTS

**REVISIONS**

DATE	DESCRIPTION
08.01.2023	NF County Comments
08.07.2023	NF Irr. & Wtr. Comm.
12.13.2023	NF Utility Outfall

**Anselmi Acres Subdivision**  
WEBER COUNTY, UTAH

**Phase 1 & 2 Utility Plan**



**Project Info.**

Engineer: J. NATE REEVE, P.E.  
 Drafter: N. FICKLIN  
 Begin Date: MAY, 2023  
 Name: ANSELMI ACRES SUBDIVISION  
 Number: 7152-19

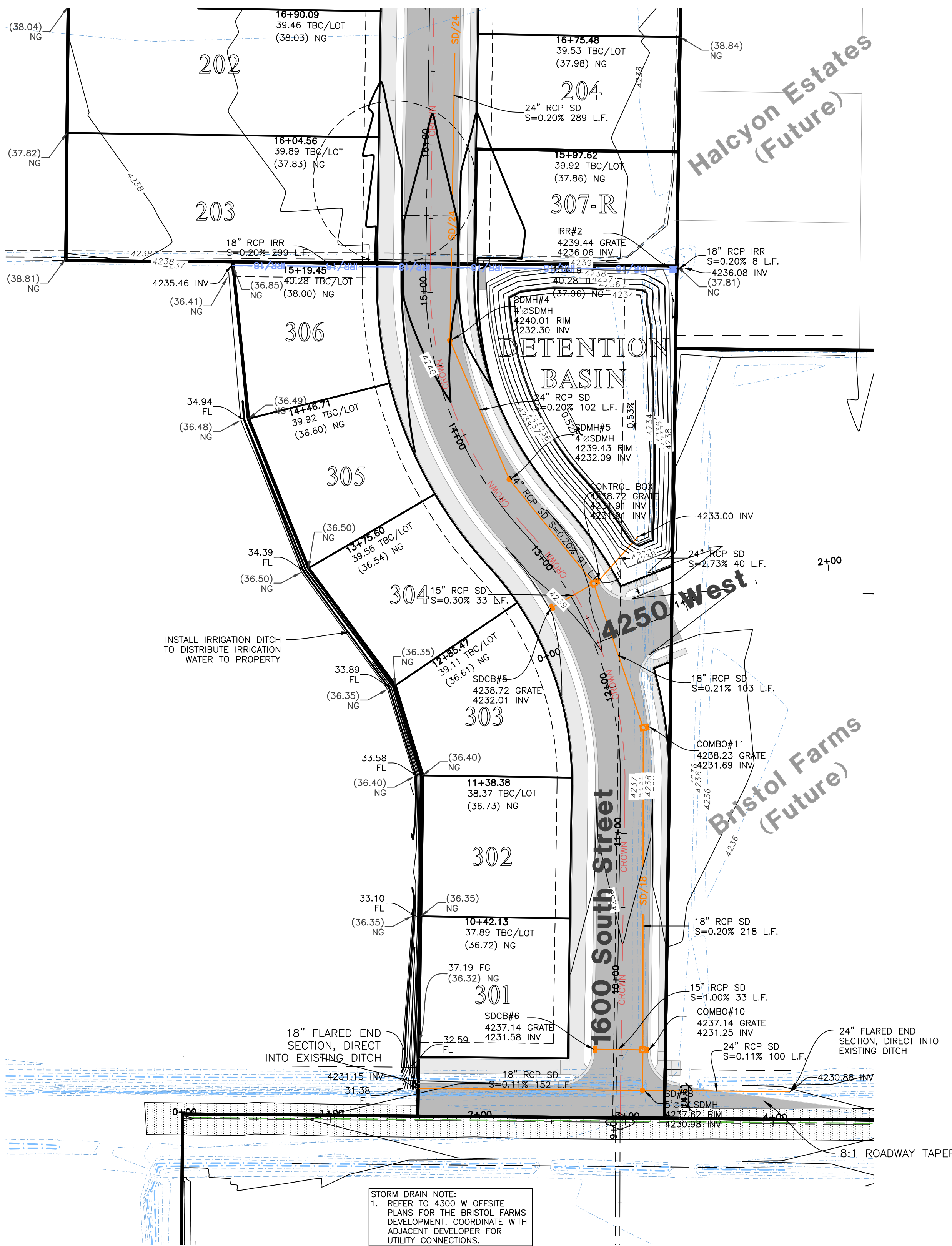

**Phase 3 Grading Plan**

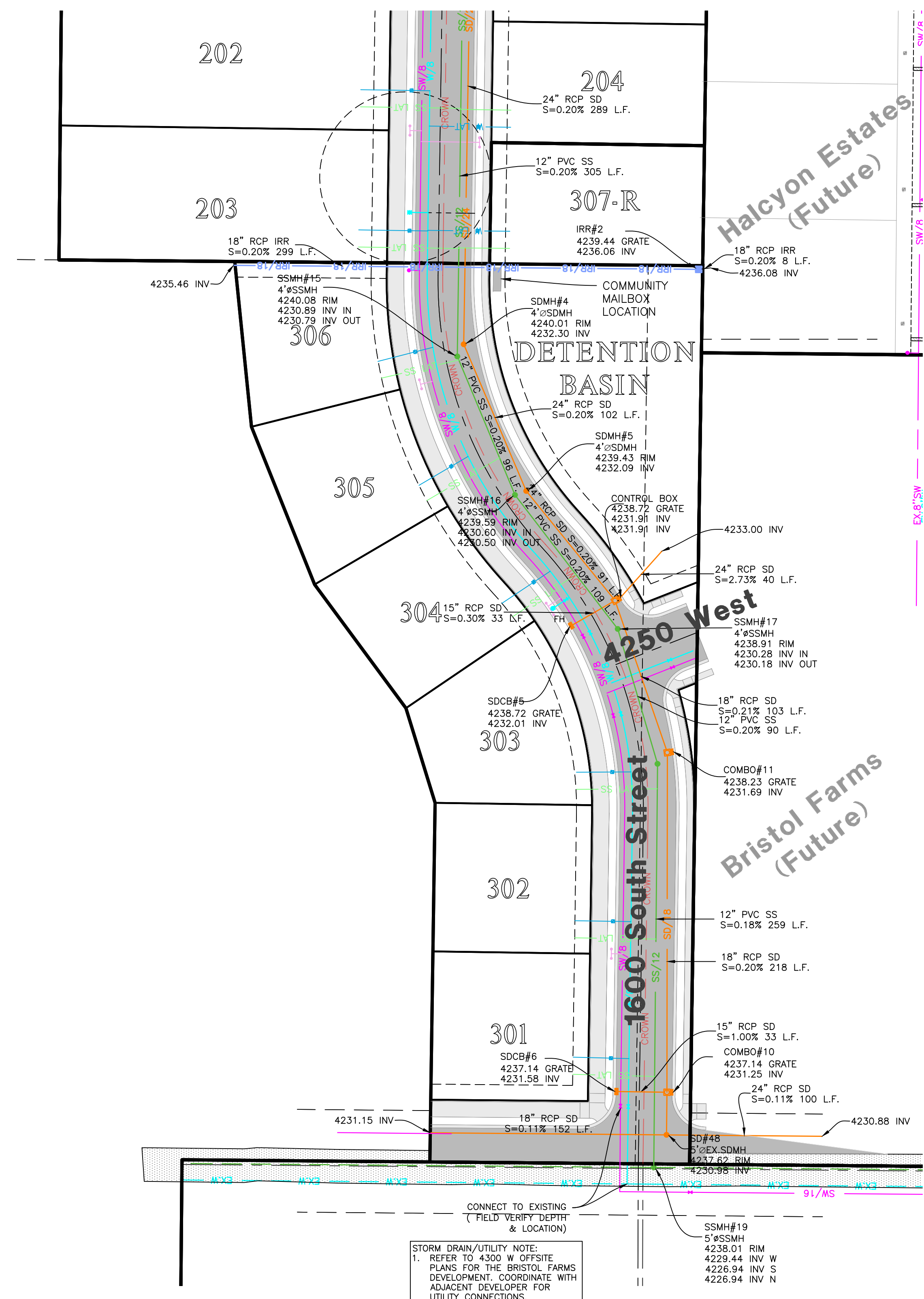
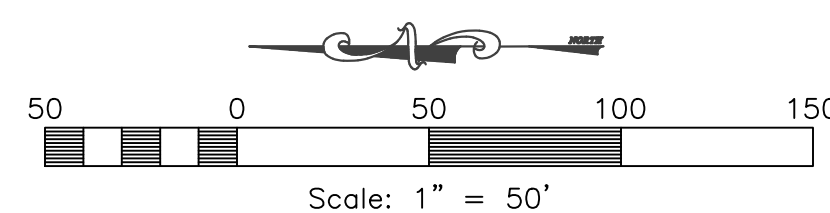

**Phase 3 Utility Plan**

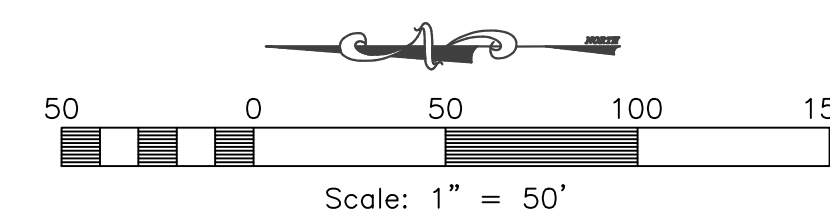

Reeve & Associates, Inc. - Solutions You Can Build On

**Reeve & Associates, Inc.**  
 5160 SOUTH 1500 WEST, RIVERDALE, UTAH 84405  
 TEL: (801) 621-3100 www.reeve.co

**RA**

LAND PLANNERS • CIVIL ENGINEERS • LAND SURVEYORS  
 TRAFFIC ENGINEERS • STRUCTURAL ENGINEERS • LANDSCAPE ARCHITECTS

REVISIONS	DATE	DESCRIPTION
	08.01.2023	NE County Comments
	08.07.2023	NE Irr. & Wtr. Comm.
	12.13.2023	NE Utility Outfall

**Anselmi Acres Subdivision**  
 WEBER COUNTY, UTAH

**Phase 3 Grading & Utility Plan**

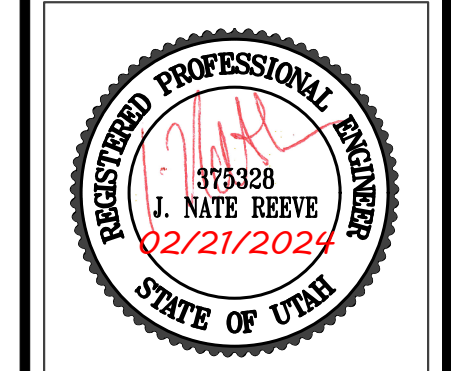

**Project Info.**

Engineer: J. NATE REEVE, P.E.  
 Drafter: N. FICKLIN  
 Begin Date: MAY, 2023  
 Name: ANSELMI ACRES SUBDIVISION  
 Number: 7152-19

**Notice:**  
 THESE PLANS WERE CREATED UTILIZING COLORS FOR UTILITIES & OTHER INFRASTRUCTURE. IF PRINTED IN, OR COPIED TO BLACK & WHITE, SOME LINE WORK MAY NOT SHOW UP PROPERLY.



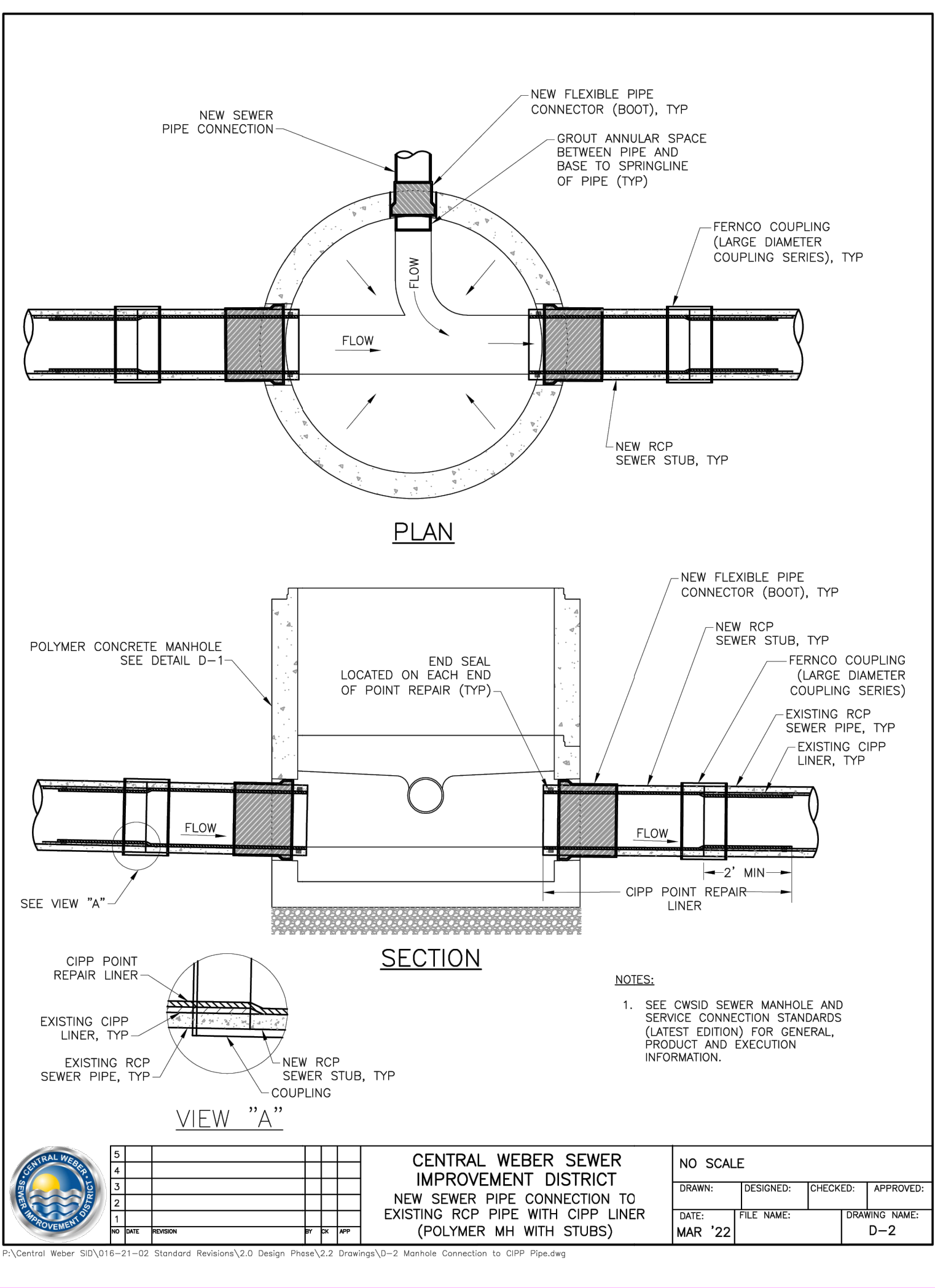
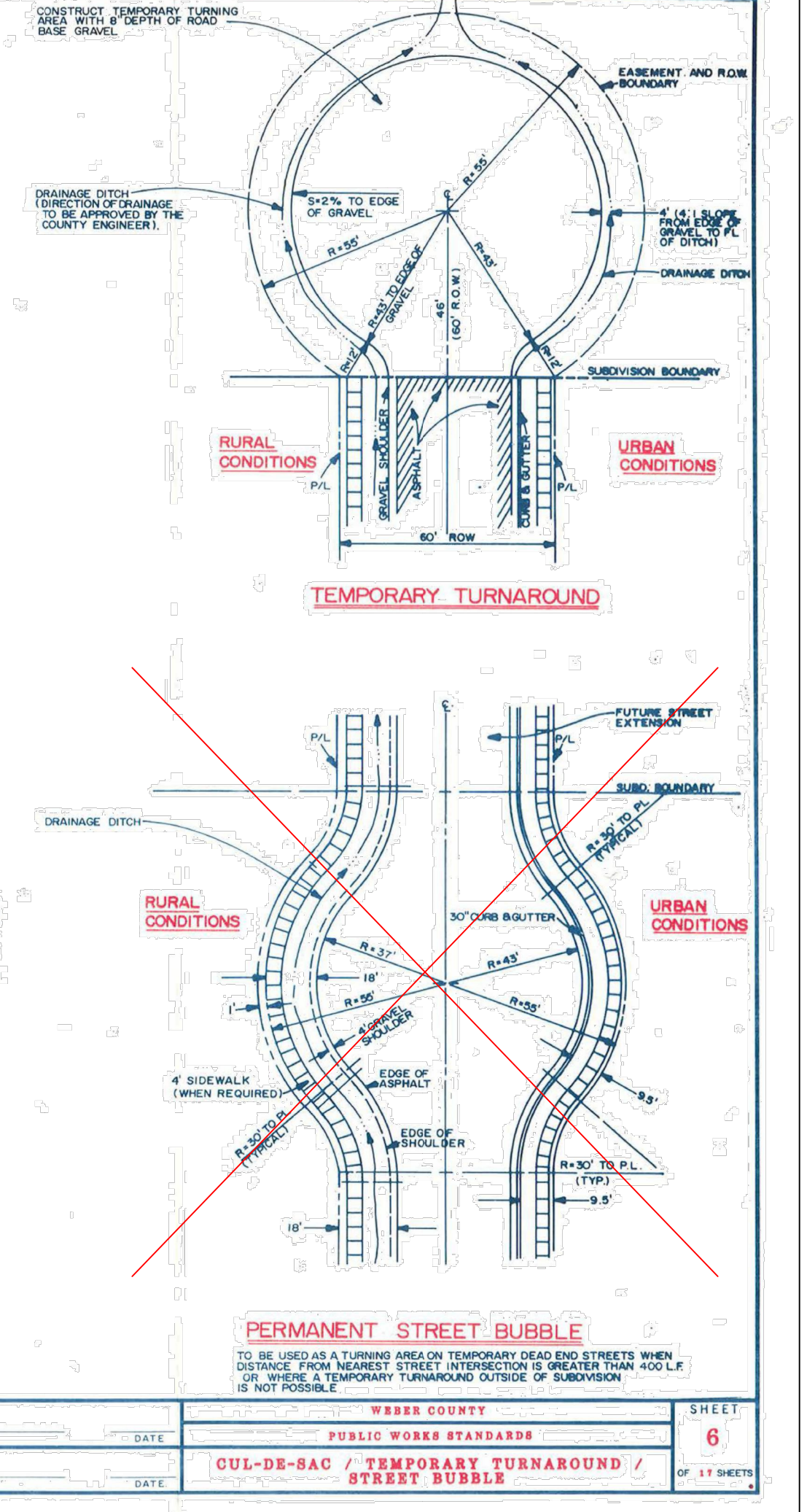
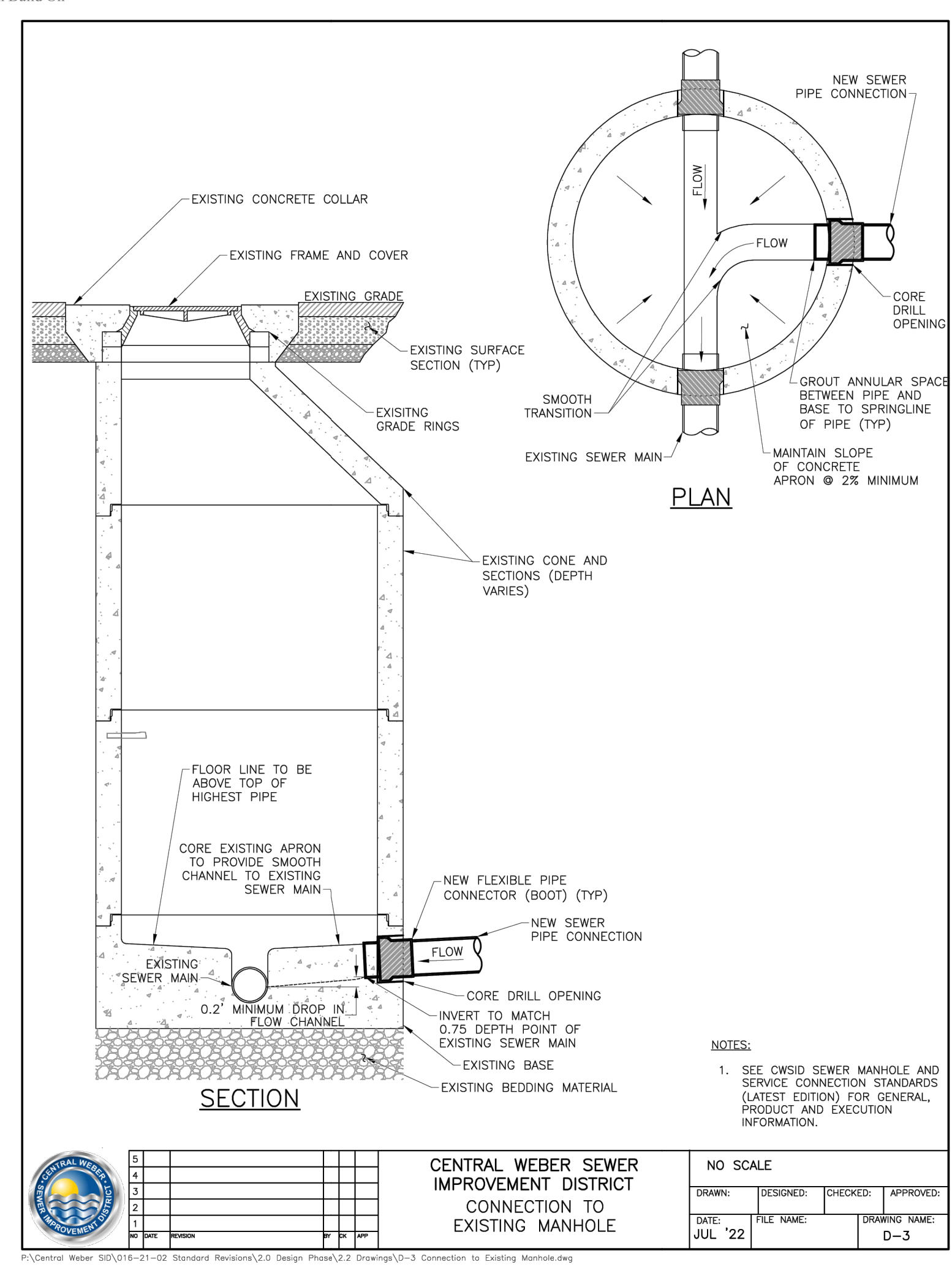
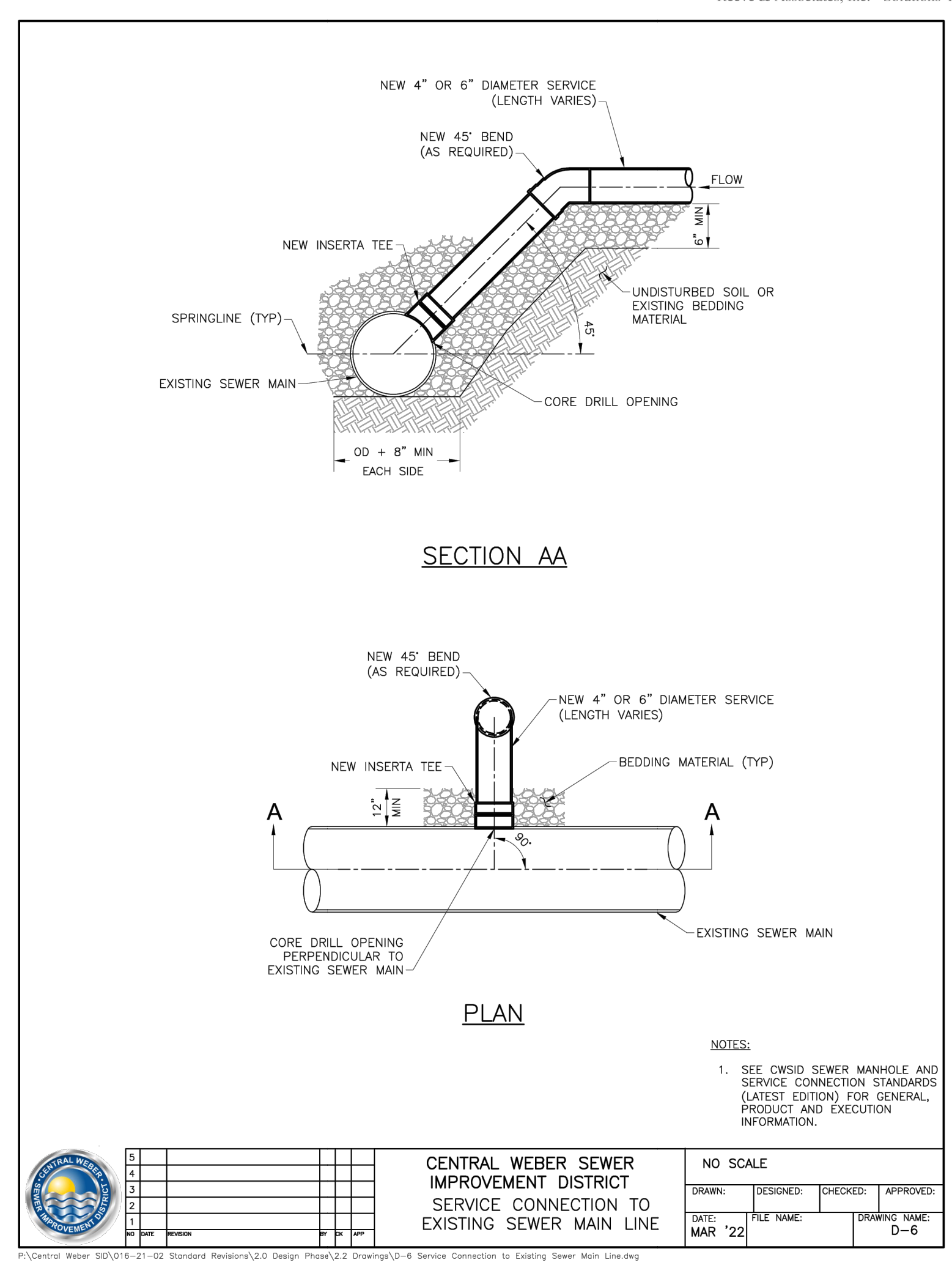
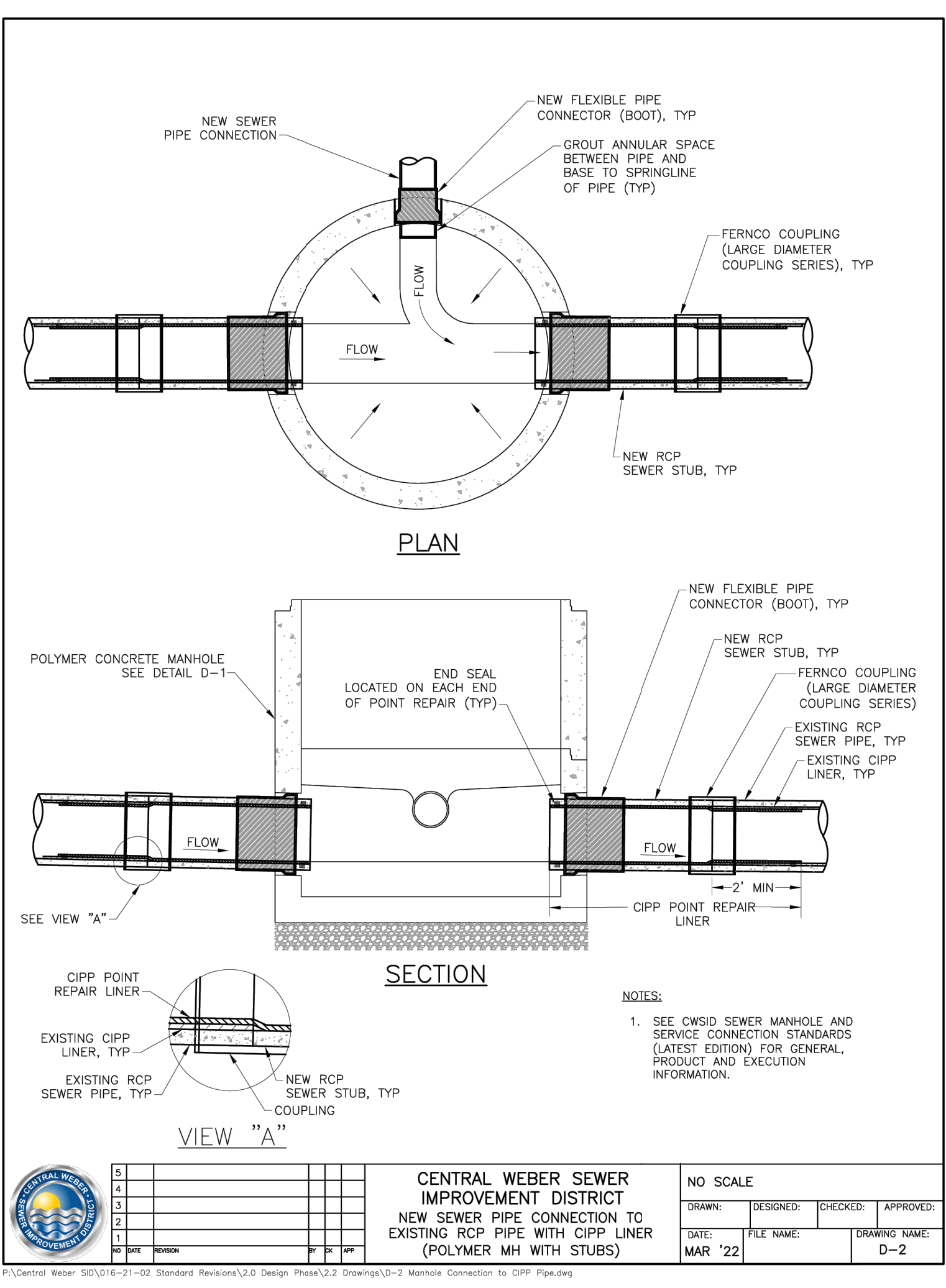

**Reeve & Associates, Inc.**  
5160 SOUTH 1500 WEST, RIVERDALE, UTAH 84405  
TEL: (801) 621-3100 www.ra-inc.com

**RA**

LAND PLANNERS • CIVIL ENGINEERS • LAND SURVEYORS  
TRAFFIC ENGINEERS • STRUCTURAL ENGINEERS • LANDSCAPE ARCHITECTS

**REVISIONS**

DATE	DESCRIPTION
08.01.2023	NE County Comments
08.07.2023	NE Irr. & Wtr. Comm.
12.13.2023	NE Utility Outfall

**Anselmi Acres Subdivision**  
WEBER COUNTY, UTAH

**Standard Details**



**Project Info.**

Engineer: J. NATE REEVE, P.E.  
 Drafter: N. FICKLIN  
 Begin Date: MAY, 2023  
 Name: ANSELMI ACRES SUBDIVISION  
 Number: 7152-19



# ANSELMI ACRES

## Storm Water Pollution Prevention Plan Exhibit

WEBER COUNTY, UTAH  
DECEMBER, 2023

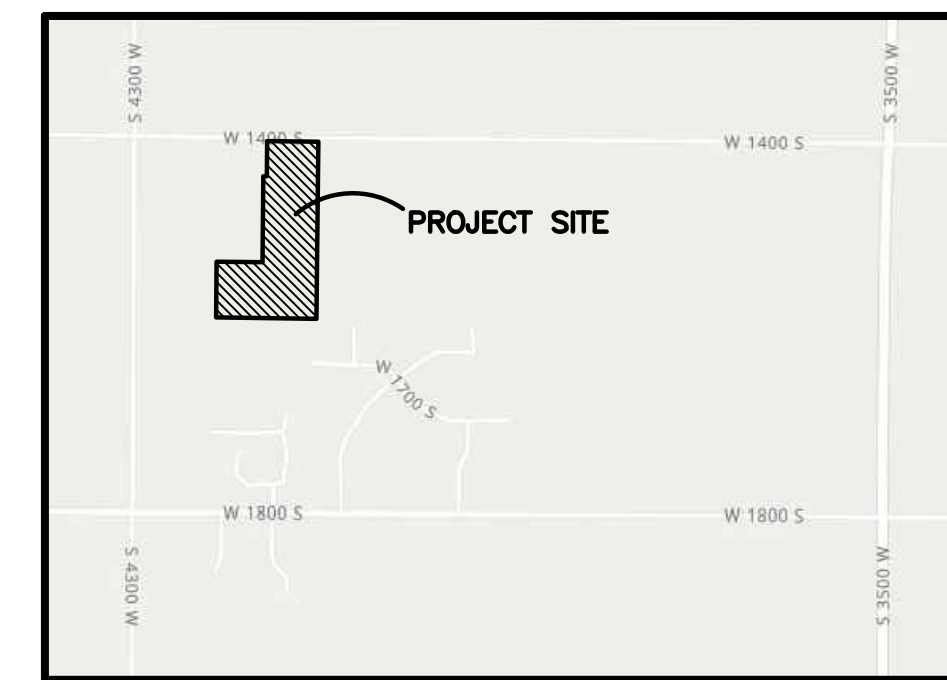

Vicinity Map  
NOT TO SCALE

**Reeve & Associates, Inc.**  
 5160 SOUTH 1500 WEST, RIVERDALE, UTAH 84405  
 TEL: (801) 621-3100 www.reeve.co

LAND PLANNERS • CIVIL ENGINEERS • LAND SURVEYORS  
 TRAFFIC ENGINEERS • STRUCTURAL ENGINEERS • LANDSCAPE ARCHITECTS

DATE	DESCRIPTION
08.01.2023	NE County Comments
08.07.2023	NE Irr. & Wtr. Comm.
12.13.2023	NE Utility Outfall

**Anselmi Acres Subdivision**  
 WEBER COUNTY, UTAH  
**Storm Water Pollution Prevention Plan Exhibit**



**Project Info.**  
 Engineer: J. NATE REEVE, P.E.  
 Drafter: N. FICKLIN  
 Begin Date: MAY, 2023  
 Name: ANSELMI ACRES SUBDIVISION  
 Number: 7152-19

**17**  
 Total Sheets

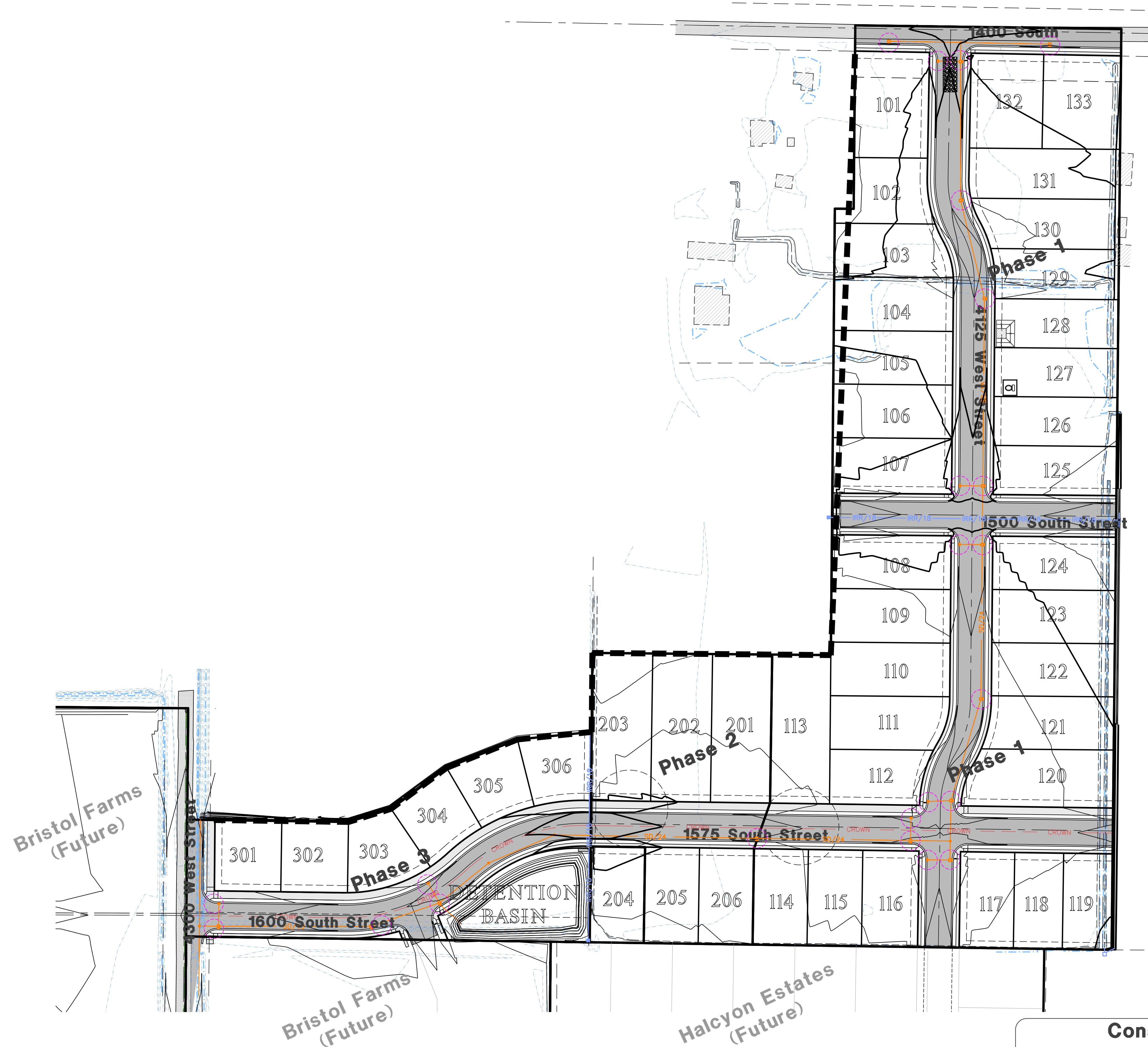

**SWPPP Legend**

- = PORTABLE TOILET
- = INLET PROTECTION TYP. (SEE DETAIL)
- = SILT FENCE (SEE DETAIL)
- = 50'x20' CONSTRUCTION ENTRANCE W/8" CLEAN GRAVEL
- = CONCRETE WASH AREA (SEE DETAIL) OR AS SELECTED BY CONTRACTOR

- SWPPP NOTES:**
- ALL VEHICLES EXITING SITE TO PROCEED THROUGH CONSTRUCTION ENTRANCE TO REDUCE AMOUNTS OF SEDIMENT TRACKED ONTO ROADWAYS.
  - STREETS TO BE SWEEPED WITHIN 1000 FEET OF CONSTRUCTION ENTRANCE DAILY IF NECESSARY

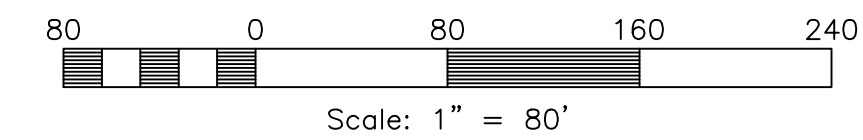

**Construction Activity Schedule**

PROJECT LOCATION.....	WEBER COUNTY, (UT)
PROJECT BEGINNING DATE.....	DECEMBER 2023
BMP'S DEPLOYMENT DATE.....	DECEMBER 2023
STORM WATER MANAGEMENT CONTACT / INSPECTOR.....	SKY HAZLEHURST (801) 837-2020
SPECIFIC CONSTRUCTION SCHEDULE INCLUDING BMP CONSTRUCTION SCHEDULE TO BE INCLUDED WITH SWPPP BY OWNER/DEVELOPER	

**Notes:**

- Describe all BMP's to protect storm water inlets:  
All storm water inlets to be protected by straw wattle barriers, or gravel bags (see detail).
- Describe BMP's to eliminate/reduce contamination of storm water from:
  - Equipment / building / concrete wash areas:  
To be performed in designated areas only and surrounded with silt fence barriers.
  - Soil contaminated by soil amendments:  
If any contaminants are found or generated, contact environmental engineer and contacts listed.
  - Areas of contaminated soil:  
If any contaminants are found or generated, contact environmental engineer and contacts listed.
  - Fueling area:  
To be performed in designated areas only and surrounded with silt fence.
  - Vehicle maintenance areas:  
To be performed in designated areas only and surrounded with silt fence.
  - Vehicle parking areas:  
To be performed in designated areas only and surrounded with silt fence.
  - Equipment storage areas:  
To be performed in designated areas only and surrounded with silt fence.
  - Materials storage areas:  
To be performed in designated areas only and surrounded with silt fence.
  - Waste containment areas:  
To be performed in designated areas only and surrounded with silt fence.
  - Service areas:  
To be performed in designated areas only and surrounded with silt fence.
- BMP's for wind erosion:  
Stockpiles and site as needed to be watered regularly to eliminate / control wind erosion
- Construction Vehicles and Equipment:
  - Maintenance
    - Keep vehicles and equipment clean; prevent excessive build-up of oil and grease.
    - Regularly inspect on-site vehicles and equipment for leaks, and repair immediately.
    - Check incoming vehicles and equipment (including delivery trucks, and employee and subcontractor vehicles) for leaking oil and fluids. Do not allow leaking vehicles or equipment on-site.
    - Segregate and recycle wastes, such as greases, used oil or oil filters, antifreeze, cleaning solutions, automotive batteries, hydraulic, and transmission fluids.
  - Fueling
    - If fueling must occur on-site, use designated areas away from drainage.
    - Locate on-site fuel storage tanks within a bermed area designed to hold the tank volume.
    - Cover retention area with an impervious material and install in a manner to ensure that any spills will be contained in the retention area. To catch spills or leaks when removing or changing fluids.
    - Use drip pans for any oil or fluid changes.
  - Washing
    - Use as little water as possible to avoid installing erosion and sediment controls for the wash area.
    - If washing must occur on-site, use designated, bermed wash areas to prevent waste water discharge into storm water, creeks, rivers, and other water bodies.
    - Use phosphate-free, biodegradable soaps.
    - Do not permit steam cleaning on-site.
- Spill Prevention and Control
  - Minor Spills:  
Minor spills are those which are likely to be controlled by on-site personnel. After contacting local emergency response agencies, the following actions should occur upon discovery of a minor spill:
    - Contain the spread of the spill.
    - If the spill occurs on paved or impermeable surfaces, clean up using "dry" methods (i.e. absorbent materials, cat litter, and / or rags).
    - If the spill occurs in dirt areas, immediately contain the spill by constructing an earth dike. Dig up and properly dispose of contaminated soil.
    - If the spill occurs during rain, cover the impacted area to avoid runoff.
    - Record all steps taken to report and contain spill.
  - Major Spills:  
On-site personnel should not attempt to control major spills until the appropriate and qualified emergency response staff have arrived at the site. For spills of federal reportable quantities, also notify the National Response Center at (800) 424-8802. A written report should be sent to all notified authorities. Failure to report major spills can result in significant fines and penalties.
- Post Roadway / Utility Construction
  - Maintain good housekeeping practices.
  - Enclose or cover building material storage areas.
  - Properly store materials such as paints and solvents.
  - Store dry and wet materials under cover, away from drainage areas.
  - Avoid mixing excess amounts of fresh concrete or cement on-site.
  - Perform washout of concrete trucks offsite or in designated areas only.
  - Do not wash out concrete trucks into storm drains, open ditches, streets or streams.
  - Do not place material or debris into streams, gutters or catch basins that stop or reduce the flow of runoff water.
  - All public streets and storm drain facilities shall be maintained free of building materials, mud and debris caused by grading or construction operations. Roads will be swept within 1000' of construction entrance daily, if necessary.
  - Install straw wattle around all inlets contained within the development and all others that receive runoff from the development.
- Erosion Control Plan Notes
  - The contractor will designate an emergency contact that can be reached 24 hours a day 7 days a week. A stand-by crew for emergency work shall be available at all times during potential rain or snow runoff events. Necessary materials shall be available on site and stockpiled at convenient locations to facilitate rapid construction of emergency devices when rain or runoff is eminent.
  - Erosion control devices shown on the plans and approved for the project may not be removed without approval of the engineer of record. If devices are removed, no work may continue that have the potential of erosion without consulting the engineer of record. If deemed necessary erosion control should be reestablished before this work begins.
  - Graded areas adjacent to fill slopes located at the site perimeter must drain away from the top of the slope at the conclusion of each working day. This should be confirmed by survey or other means acceptable to the engineer of record.
  - All silt and debris shall be removed from all devices within 24 hours after each rain or runoff event.
  - Except as otherwise approved by the inspector, all removable protective devices shown shall be in place at the end of each working day and through weekends until removal of the system is approved.
  - All loose soil and debris, which may create a potential hazard to offsite property, shall be removed from the site as directed by the engineer of record of the governing agency.
  - The placement of additional devices to reduce erosion damage within the site is left to the discretion of the engineer of record.
  - Desilting basins may not be removed or made inoperable without the approval of the engineer of record and the governing agency.
  - Erosion control devices will be modified as need as the project progresses and plans of these changes submitted for approval by the engineer of record and the governing agency.
- Conduct a minimum of one inspection of the erosion and sediment controls every two weeks. Maintain documentation on site.
  - Part III.D.4 of general permit UTRC00000 identifies the minimum inspection requirements.
  - Part III.D.4.C identifies the minimum inspection report requirements.
  - Failure to complete and/or document storm water inspections is a violation of part III.D.4 of Utah General Permit UTR 300000.

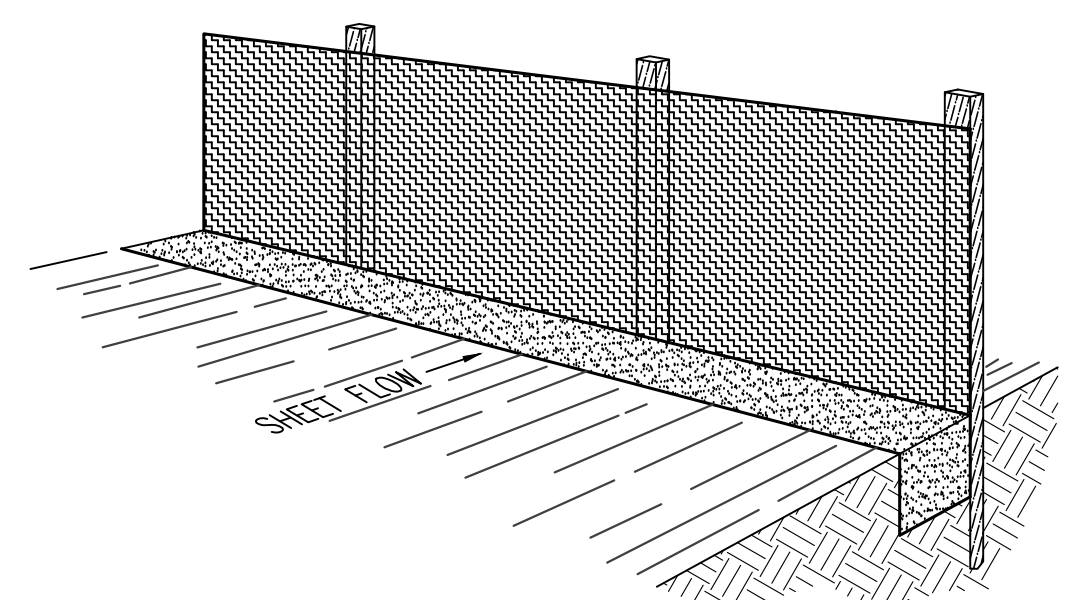

**Perspective View**

Figure 2

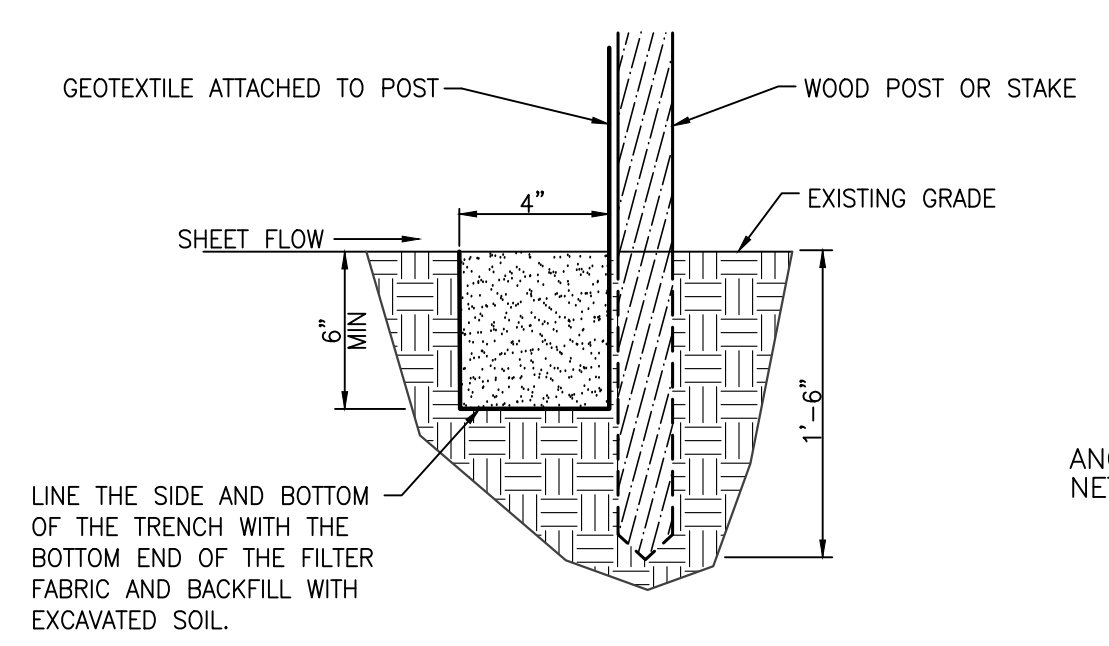

**Section**

**INSTALLATION**  
The silt fence should be installed prior to major soil disturbances in the drainage area. The fence should be placed across the slope along a line of uniform elevation wherever flow of sediment is anticipated. Table 1 shows generally-recommended maximum slope lengths (slope spacing between fences) at various site grades for most silt fence applications.

Slope Steepness (%)	Max. Slope Length m (ft)
<2%	30.5m (100ft)
2-5%	22.9m (75ft)
5-10%	15.2m (50ft)
10-20%	7.6m (25ft)
>20%	4.5m (15ft)

**PREFABRICATED SILT FENCE ROLLS**  
\*Excavate a minimum 15.2cm x 15.2cm (6"x6") trench at the desired location.  
\*Unroll the silt fence, positioning the post against the downstream wall of the trench.  
\*Adjacent rolls of silt fence should be joined by nesting the end post of one fence into the other. Before nesting the end posts, rotate each post until the geotextile is wrapped completely around the post, then abut the end posts to create a tight seal as shown in Figure 1.  
\*Drive posts into the ground until the required fence height and/or anchorage depth is obtained.  
\*Bury the loose geotextile at the bottom of the fence in the upstream trench and backfill with natural soil, tamping the backfill to provide good compaction and anchorage. Figure 2 illustrates a typical silt fence installation and anchor trench placement.

should generally be less than three (3) times the height of the fence.  
\*If a steel or plastic mesh is required to reinforce the geotextile, it shall have a minimum mesh opening of 15.2cm (6").  
\*Fasten the mesh to the upslope side of the posts using heavy duty wire staples, tie wires or hog strings. Extend the mesh into the bottom of the trench.  
\*The geotextile shall then be stapled or wired to the posts. An extra 20-50cm (8-20") of geotextile shall extend into the trench.

**INSPECTION**  
\*Inspect the silt fence daily during periods of rainfall, immediately after significant rainfall event and weekly during periods of no rainfall. Make any repairs immediately.  
\*When sediment deposits behind the silt fence are one-third of the fence height, remove and properly dispose of the silt accumulations. Avoid damage to the fabric during cleanout.

**REMOVAL**  
\*Silt fence should not be removed until construction ceases and the upslope area has been properly stabilized and/or revegetated.

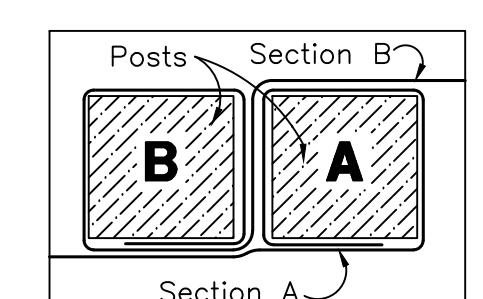
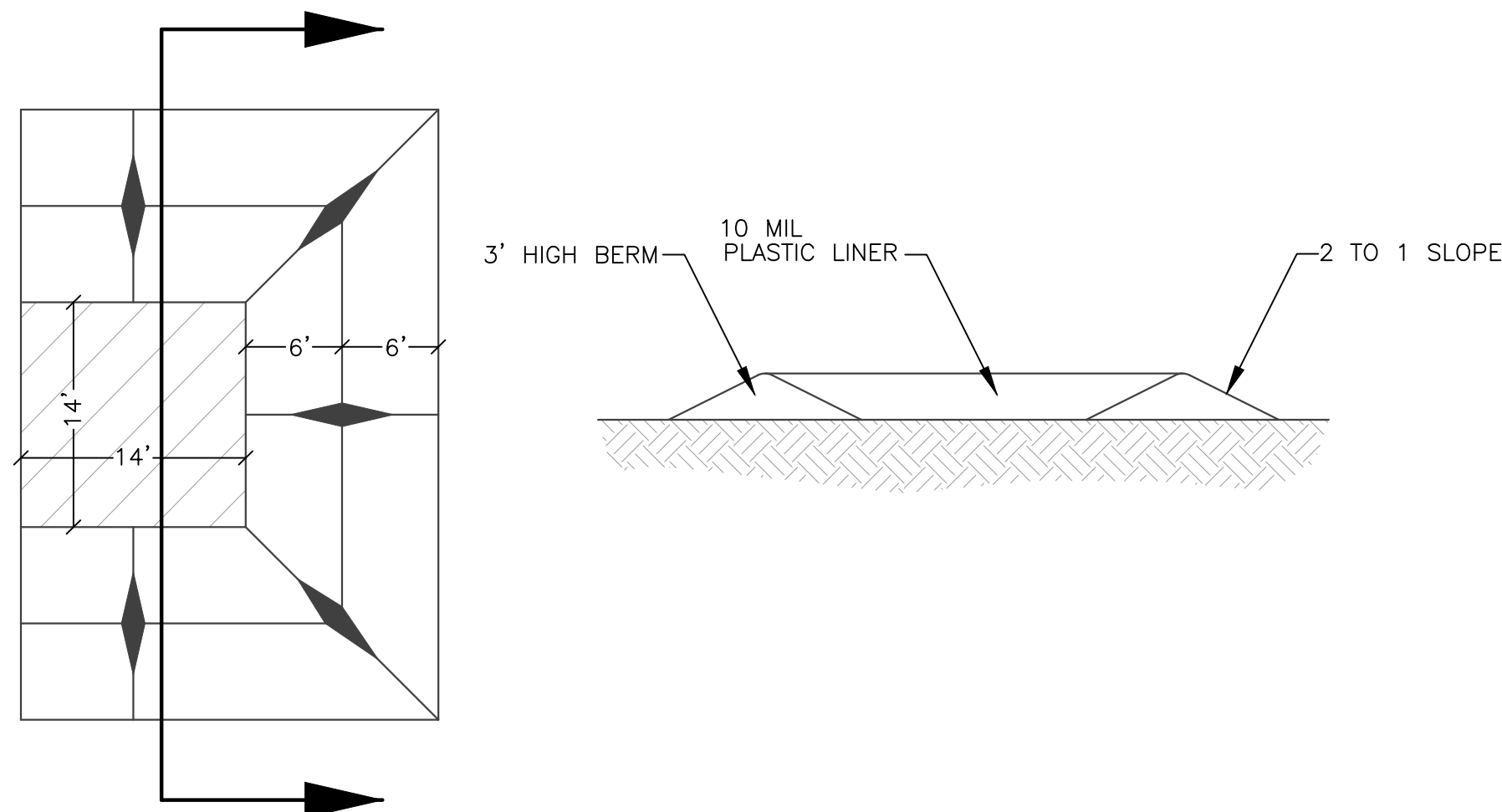

Figure 1: Top View of Roll-to-Roll Connection

**FIELD ASSEMBLY:**  
\*Excavate a minimum 15.2cm x 15.2cm (6"x6") trench at the desired location.  
\*Drive wooden posts, or steel posts with fastening projections, against the downstream wall of the trench. Maximum post spacing should be 2.4-3.0m (8-10ft). Post spacing

**Silt Fence Detail**

SCALE: NONE



**Concrete Washout Area w/ 10 mil Plastic Liner**

SCALE: NONE

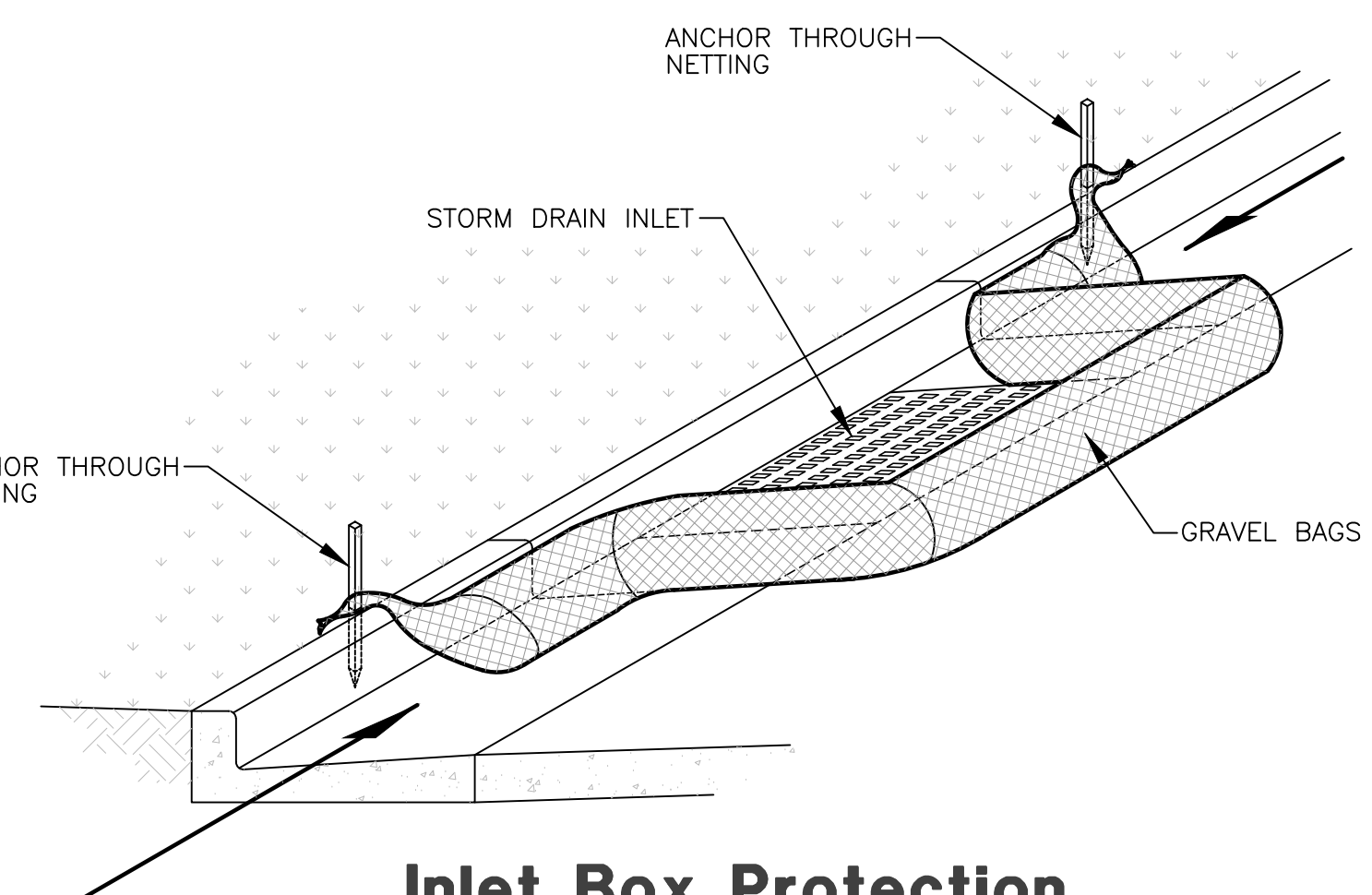

**Inlet Box Protection**

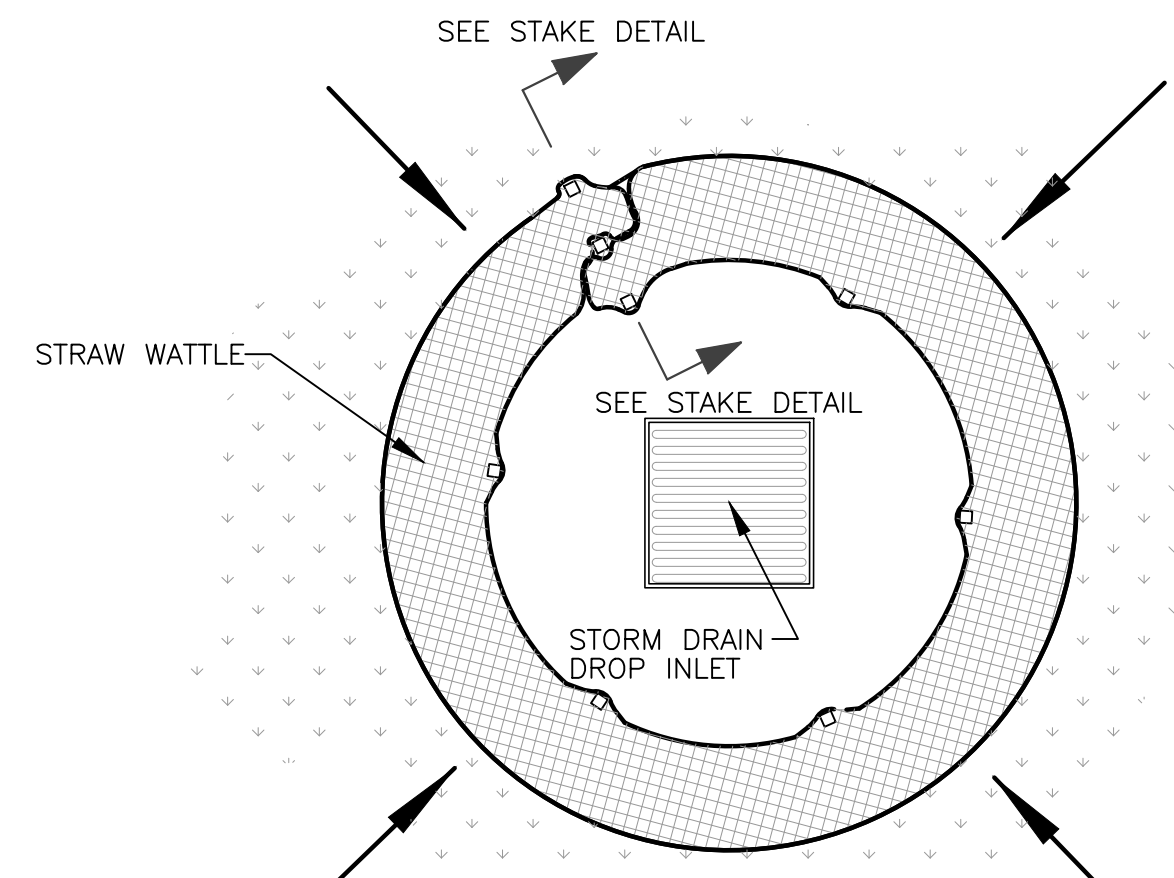

**Plan View**

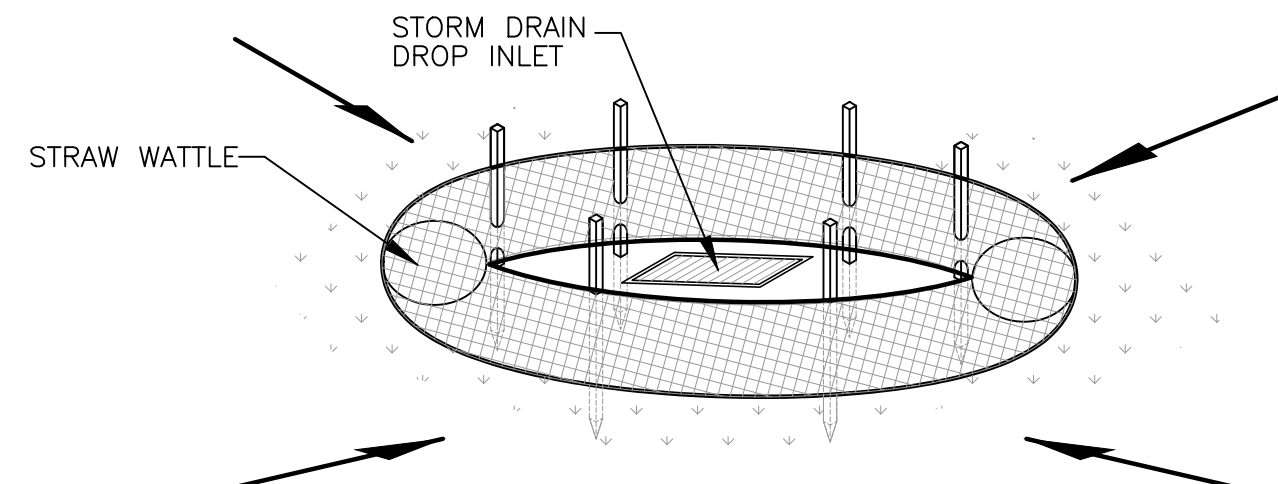

**Drop Inlet Protection**

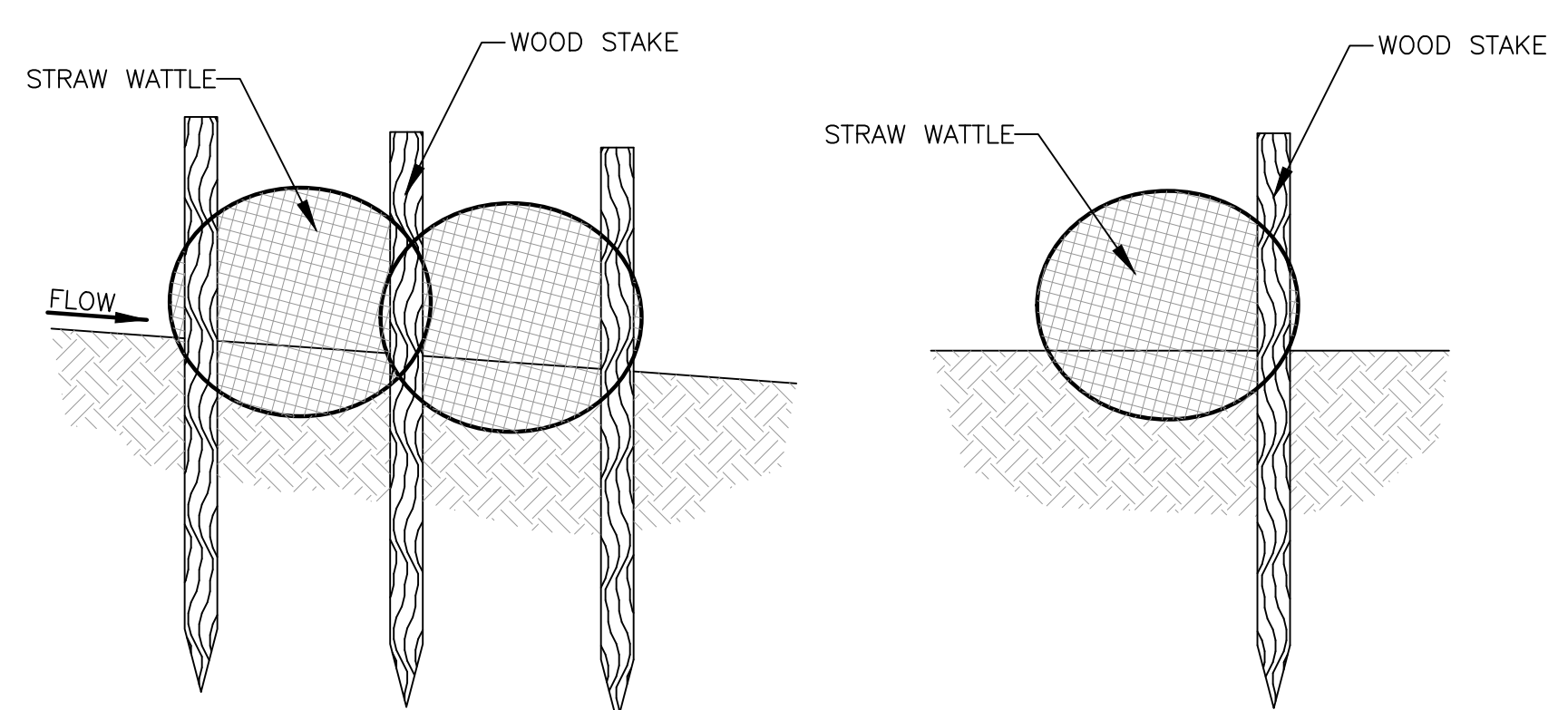

**Stake Detail**

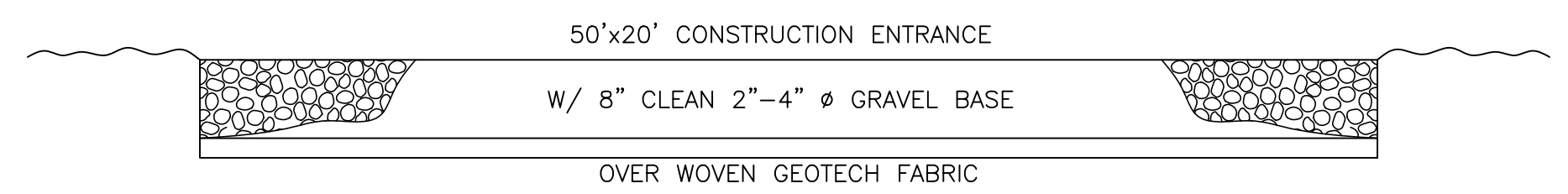

**Cross Section 50' x 20' Construction Entrance**

**Reeve & Associates, Inc.**  
5160 SOUTH 1500 WEST, RIVERDALE, UTAH 84405  
TEL: (801) 621-3100 www.reeve.co

**RA**

LAND PLANNERS • CIVIL ENGINEERS • LAND SURVEYORS  
TRAFFIC ENGINEERS • STRUCTURAL ENGINEERS • GEOTECH ENGINEERS

REVISIONS	DATE	DESCRIPTION
08.01.2023	NE	County Comments
08.07.2023	NE	Irr. & Wtr. Comm.
12.13.2023	NE	Utility Outfall

**Anselmi Acres Subdivision**  
WEBER COUNTY, UTAH

**Storm Water Pollution Prevention Plan Details**

**REGISTERED PROFESSIONAL ENGINEER**  
375328  
J. NATE REEVE  
02/21/2024  
STATE OF UTAH

**Project Info.**  
Engineer: J. NATE REEVE, P.E.  
Drafter: N. FICKLIN  
Begin Date: MAY, 2023  
Name: ANSELMI ACRES SUBDIVISION  
Number: 7152-19