



BENCHMARK
NORTHWEST CORNER OF SECTION 27 TOWNSHIP 7 NORTH, RANGE 2 WEST SALT LAKE BASE AND MERIDIAN ELEV = 4231.00'

JDC PARKWAY

2800 WEST 2600 NORTH STREET
WEBER COUNTY, UTAH

INDEX OF DRAWINGS

1 OF 1	SUBDIVISION PLAT
C-001	GENERAL NOTES
C-002	OVERALL DEVELOPMENT SITE PLAN
C-100	SITE PLAN
C-101	STRIPING PLAN
C-200	OVERALL GRADING AND DRAINAGE PLAN
C-201	GRADING PLAN
C-202	OFFSITE GRADING PLAN
C-300	UTILITY PLAN
C-301	OFFSITE UTILITY PLAN
C-400	EROSION CONTROL PLAN
PP-0	PLAN AND PROFILE KEY MAP
PP-1	OFFSITE UTILITY PLAN AND PROFILE
PP-2	OFFSITE UTILITY PLAN AND PROFILE
PP-3	JDC PARKWAY PLAN AND PROFILE
PP-4	JDC PARKWAY PLAN AND PROFILE
PP-5	2725 NORTH STREET PLAN AND PROFILE
PP-6	OFFSITE UTILITY PLAN AND PROFILE
C-500	DETAILS
C-501	DETAILS

FOR REVIEW
NOT FOR CONSTRUCTION

DATE PRINTED
November 13, 2023

NOTICE TO CONTRACTOR

ALL CONTRACTORS AND SUBCONTRACTORS PERFORMING WORK SHOWN ON OR RELATED TO THESE PLANS SHALL CONDUCT THEIR OPERATIONS SO THAT ALL EMPLOYEES ARE PROVIDED A SAFE PLACE TO WORK AND THE PUBLIC IS PROTECTED. ALL CONTRACTORS AND SUBCONTRACTORS SHALL COMPLY WITH THE OCCUPATIONAL SAFETY AND HEALTH REGULATIONS OF THE U.S. DEPARTMENT OF LABOR AND THE STATE OF UTAH DEPARTMENT OF INDUSTRIAL RELATIONS CONSTRUCTION SAFETY ORDERS. THE CIVIL ENGINEER SHALL NOT BE RESPONSIBLE IN ANY WAY FOR THE CONTRACTORS AND SUBCONTRACTORS COMPLIANCE WITH SAID REGULATIONS AND ORDERS.

CONTRACTOR FURTHER AGREES TO ASSUME SOLE AND COMPLETE RESPONSIBILITY FOR JOB-SITE CONDITIONS DURING THE COURSE OF CONSTRUCTION OF THIS PROJECT, INCLUDING SAFETY OF ALL PERSONS AND PROPERTY. THAT THIS REQUIREMENT SHALL APPLY CONTINUOUSLY AND NOT BE LIMITED TO NORMAL WORKING HOURS, AND THAT THE CONTRACTOR SHALL DEFEND, INDEMNIFY AND HOLD THE OWNER AND THE CIVIL ENGINEER HARMLESS FROM ANY AND ALL LIABILITY, REAL OR ALLEGED IN CONNECTION WITH THE PERFORMANCE OF WORK ON THIS PROJECT, EXCEPTING FOR LIABILITY ARISING FROM THE SOLE NEGLIGENCE OF THE OWNER OR ENGINEER.

NOTICE TO DEVELOPER/ CONTRACTOR

UNAPPROVED DRAWINGS REPRESENT WORK IN PROGRESS, ARE SUBJECT TO CHANGE, AND DO NOT CONSTITUTE A FINISHED ENGINEERING PRODUCT. ANY WORK UNDERTAKEN BY DEVELOPER OR CONTRACTOR BEFORE PLANS ARE APPROVED IS UNDERTAKEN AT THE SOLE RISK OF THE DEVELOPER, INCLUDING BUT NOT LIMITED TO BIDS, ESTIMATION, FINANCING, BONDING, SITE CLEARING, GRADING, INFRASTRUCTURE CONSTRUCTION, ETC.

UTILITY DISCLAIMER

THE CONTRACTOR IS SPECIFICALLY CAUTIONED THAT THE LOCATION AND / OR ELEVATIONS OF EXISTING UTILITIES AS SHOWN ON THESE PLANS IS BASED ON RECORDS OF THE VARIOUS UTILITY COMPANIES AND WHERE POSSIBLE, MEASUREMENTS TAKEN IN THE FIELD. THE INFORMATION IS NOT TO BE RELIED ON AS BEING EXACT OR COMPLETE. THE CONTRACTOR MUST CALL THE LOCAL UTILITY LOCATION CENTER AT LEAST 48 HOURS BEFORE ANY EXCAVATION TO REQUEST EXACT FIELD LOCATIONS OF UTILITIES. IT SHALL BE THE RESPONSIBILITY OF THE CONTRACTOR TO RELOCATE ALL EXISTING UTILITIES WHICH CONFLICT WITH THE PROPOSED IMPROVEMENTS SHOWN ON THE PLANS.

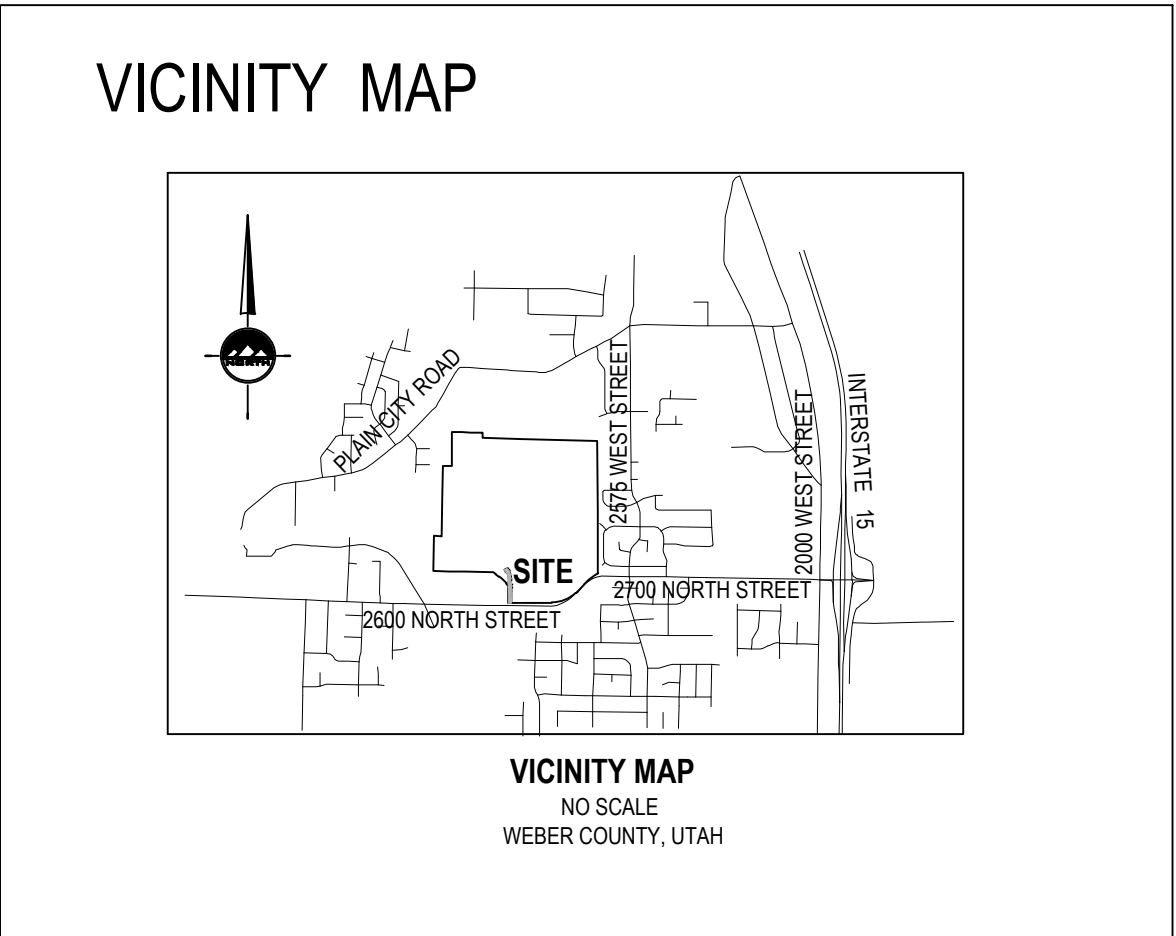
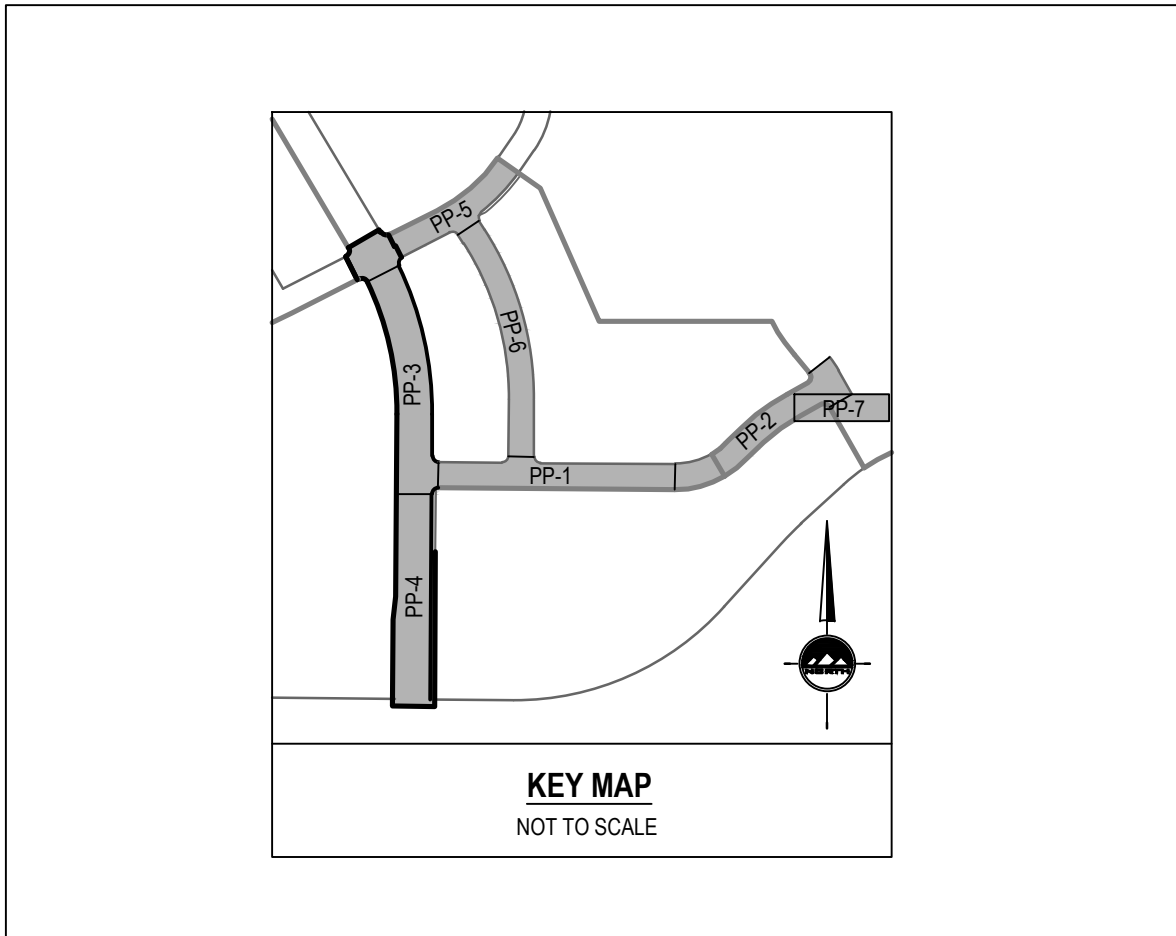

GENERAL NOTES

- ALL WORK SHALL CONFORM TO WEBER COUNTY STANDARDS & SPECIFICATIONS.
- CALL BLUE STAKES AT LEAST 48 HOURS PRIOR TO THE COMMENCEMENT OF ANY CONSTRUCTION ACTIVITIES.

EN SIGN
THE STANDARD IN ENGINEERING

LAYTON
919 North 400 West
Layton, UT 84041
Phone: 801.547.1100

SANDY
Phone: 801.255.0529

TOOELE
Phone: 435.843.3590

CEDAR CITY
Phone: 435.865.1453

RICHFIELD
Phone: 435.896.2983

WWW.ENSIGNENG.COM

FOR:
NILSON HOWES
1740 COMBE RD, SUITE 2
SOUTH OGDEN, UT 84403

CONTACT:
STEVE ANDERSON
PHONE: 801.392.8100

JDC PARKWAY
2800 WEST 2600 NORTH STREET
WEBER COUNTY, UTAH



NO.	DATE	REVISION FOR REVIEW

COVER

PROJECT NUMBER: 9872
PRINT DATE: 2023-11-13
PROJECT MANAGER: CP
DESIGNED BY: TS

JDC PARKWAY ROADWAY DEDICATION

LOCATED IN THE SOUTHEAST QUARTER OF SECTION 27
AND THE NORTHEAST QUARTER OF SECTION 34,
TOWNSHIP 7 NORTH, RANGE 2 WEST
SALT LAKE BASE AND MERIDIAN
WEBER COUNTY, UTAH
NOVEMBER 2023

GENERAL NOTES:

- UTILITIES SHALL HAVE THE RIGHT TO INSTALL, MAINTAIN, AND OPERATE THEIR EQUIPMENT ABOVE AND BELOW GROUND AND ALL OTHER RELATED FACILITIES WITHIN THE PUBLIC UTILITY EASEMENTS IDENTIFIED ON THIS PLAT MAP AS MAY BE NECESSARY OR DESIRABLE IN PROVIDING UTILITY SERVICES WITHIN AND WITHOUT THE LOTS IDENTIFIED HEREIN, INCLUDING THE RIGHT OF ACCESS TO SUCH FACILITIES AND THE RIGHT TO REQUIRE REMOVAL OF ANY OBSTRUCTIONS INCLUDING STRUCTURES, TREES AND VEGETATION THAT MAY BE PLACED WITHIN THE P.U.E. THE UTILITY MAY REQUIRE THE LOT OWNER TO REMOVE ALL STRUCTURES WITHIN THE P.U.E. AT THE LOT OWNER'S EXPENSE, OR THE UTILITY MAY REMOVE SUCH STRUCTURES AT THE LOT OWNER'S EXPENSE. AT NO TIME MAY ANY PERMANENT STRUCTURES BE PLACED WITHIN THE P.U.E. OR ANY OTHER OBSTRUCTION WHICH INTERFERES WITH THE USE OF THE P.U.E. WITHOUT THE PRIOR WRITTEN APPROVAL OF THE UTILITIES WITH FACILITIES IN THE P.U.E.
- PROTECT ALL EXISTING SECTION CORNERS AND STREET MONUMENTS. COORDINATE ALL SURVEY STREET MONUMENT INSTALLATION, GRADE ADJUSTMENT, AND ALL REQUIRED FEES AND PERMITS WITH THE COUNTY SURVEYOR PRIOR TO DISRUPTION OF ANY EXISTING MONUMENTS.

LEGEND

- SECTION CORNER
- PROPOSED STREET MONUMENT
- SET 5/8" X 2/4" REBAR WITH YELLOW PLASTIC CAP, OR NAIL STAMPED "ENSGN ENG. & LAND SURV."
- PROPERTY LINE
- ROAD CENTERLINE
- SECTION LINE

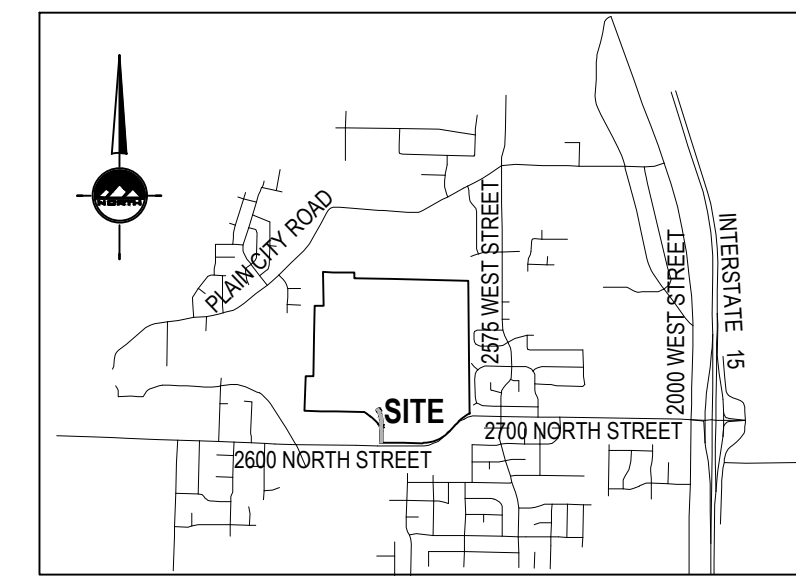

VICINITY MAP
NO SCALE
WEBER COUNTY, UTAH

CURVE TABLE					
CURVE	RADIUS	LENGTH	DELTA	BEARING	CHORD
PC1	15.00'	8.19'	31°17'33"	S15°15'06"E	8.09'
PC2	45.00'	33.95'	43°13'24"	S67°59'37"E	33.15'
PC3	60.00'	40.51'	38°40'56"	S71°03'13"W	39.74'
PC4	91.00'	75.34'	47°26'02"	N23°19'20"W	73.20'
PC5	62.50'	102.96'	94°23'02"	N0°23'10"E	91.70'
PC6	91.00'	74.79'	47°05'30"	N23°56'26"E	72.71'
PC7	708.50'	322.15'	26°03'08"	N12°37'53"W	319.38'
PC8	15.00'	23.91'	91°20'36"	N71°19'45"W	21.46'
PC9	15.00'	24.54'	93°43'06"	N16°08'24"E	21.89'
PC10	15.00'	22.59'	86°16'54"	S73°51'36"E	20.51'
PC11	15.00'	23.26'	88°50'41"	S18°34'36"W	21.00'
PC12	791.50'	362.49'	26°14'26"	S12°43'32"E	359.33'

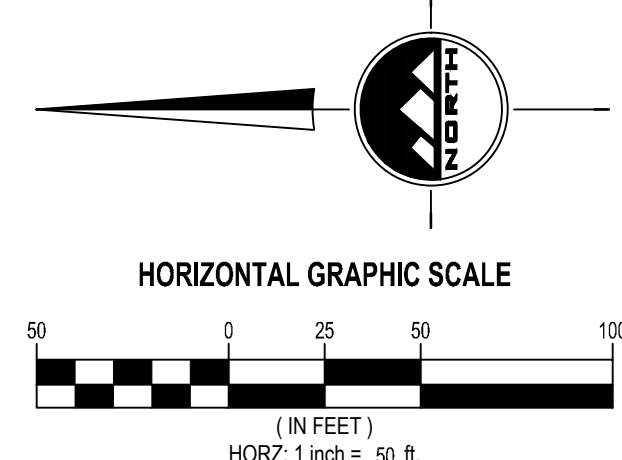
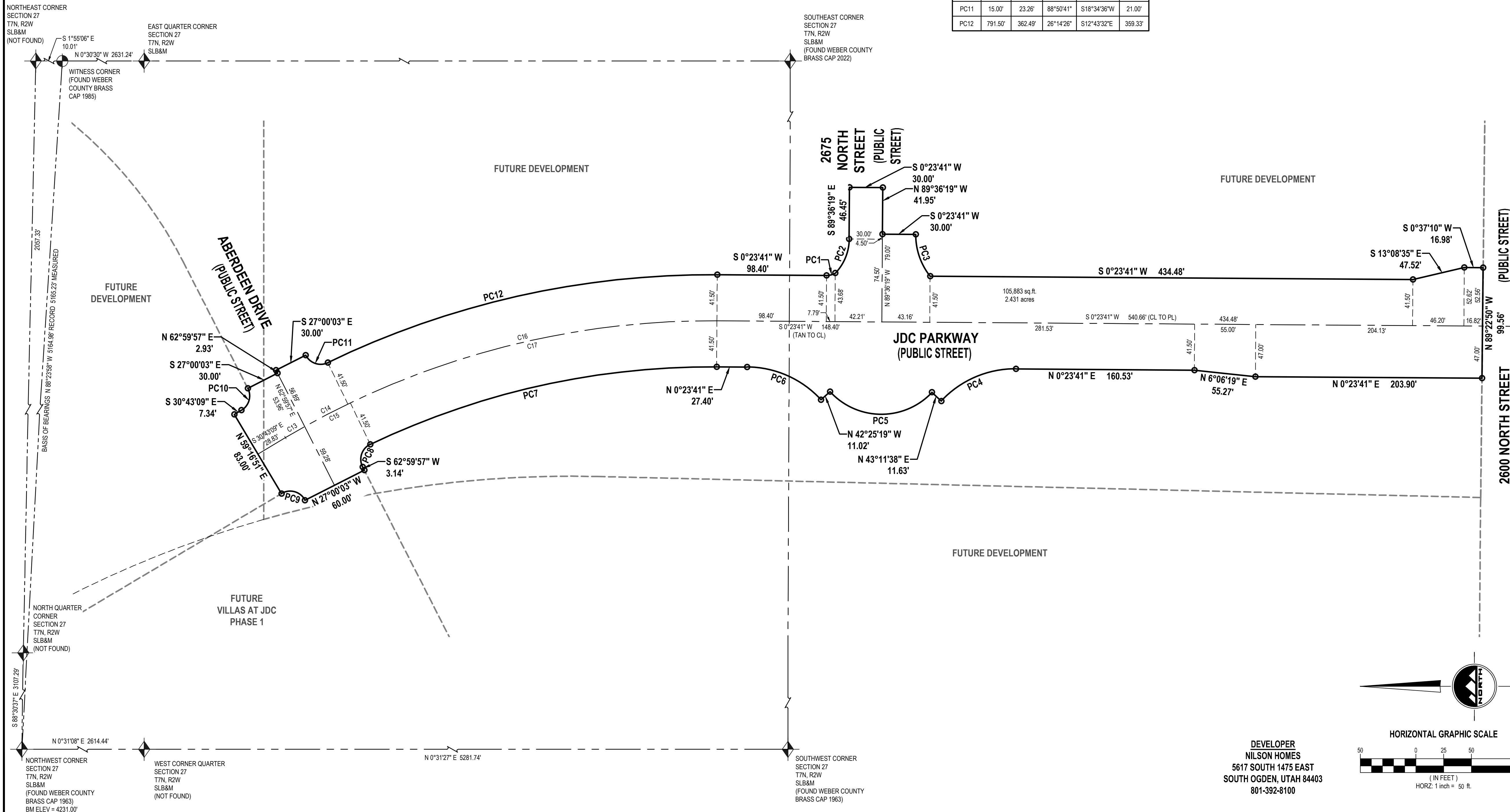

DEVELOPER
NILSON HOMES
5617 SOUTH 1475 EAST
SOUTH OGDEN, UTAH 84403
801-392-8100

SURVEYOR'S CERTIFICATE

I, TRENT R. WILLIAMS do hereby certify that I am a Licensed Land Surveyor, and that I hold certificate No. 8034679 as prescribed under laws of the State of Utah. I further certify that by authority of the Owners, I have made a survey of the tract of land shown on this plat and described below, and have subdivided said tract of land into lots and streets, hereafter to be known as JDC PARKWAY ROADWAY DEDICATION and that the same has been correctly surveyed and staked on the ground as shown on this plat. I further certify that all lots meet frontage width and area requirements of the applicable zoning ordinances.

BOUNDARY DESCRIPTION

Trent R. Williams, PLS
License no. 8034679

Date _____

OWNER'S DEDICATION

We(I) the undersigned owners of the above described tract of land, do hereby set apart and subdivide the same into lots and streets (private streets/private right-of-way's) as shown hereon and name said tract.

JDC PARKWAY ROADWAY DEDICATION

do hereby dedicate for perpetual use of the public all parcels of land shown on this plat as intended for Public use.

In witness whereof We(I) have hereto set our hands(s) this _____ day of _____ A.D., 20____.

By: _____

LIMITED LIABILITY COMPANY ACKNOWLEDGMENT

STATE OF UTAH
County of Weber JS.S.

On the _____ day of _____ A.D., 20____, _____ in the State of Utah, who after being duly sworn, acknowledged to me that He is the Manager, of West Park Community LLC a Limited Liability Company and that He signed the Owner's Dedication freely and voluntarily for and in behalf of said Limited Liability Company for the purposes therein mentioned and acknowledged to me that said Limited Liability Company executed the same.

MY COMMISSION EXPIRES: _____

RESIDING IN _____ COUNTY.

NOTARY PUBLIC

JDC PARKWAY ROADWAY DEDICATION

LOCATED IN THE SOUTHEAST QUARTER OF SECTION 27 AND THE NORTHEAST QUARTER OF SECTION 34, TOWNSHIP 7 NORTH, RANGE 2 WEST, SALT LAKE BASE AND MERIDIAN, WEBER COUNTY, UTAH

<p>LAYTON 919 North 400 West Layton UT 84041 Phone: 801.547.1100 Fax: 801.593.6315 WWW.ENSGNENG.COM</p> <p>SALT LAKE CITY Phone: 801.593.6309 TODDLE Phone: 435.843.3590 CEDAR CITY Phone: 435.865.1453 RICHFIELD Phone: 435.989.2983</p>	<h4>COUNTY ATTORNEY'S APPROVAL</h4> <p>APPROVED THIS _____ DAY OF _____, 20____.</p> <p>BY THE WEBER COUNTY ATTORNEY _____</p> <p>WEBER COUNTY ATTORNEY</p>	<h4>PLANNING COMMISSION APPROVAL</h4> <p>APPROVED THIS _____ DAY OF _____, 20____.</p> <p>BY THE COUNTY PLANNING COMMISSION APPROVAL _____</p> <p>CHAIRMAN, WEBER COUNTY PLANNING COMMISSION</p>	<h4>COUNTY ENGINEER'S APPROVAL</h4> <p>APPROVED THIS _____ DAY OF _____, 20____.</p> <p>BY THE WEBER COUNTY ENGINEER _____</p> <p>WEBER COUNTY ENGINEER</p>	<h4>COUNTY COUNCIL APPROVAL</h4> <p>APPROVED THIS _____ DAY OF _____, 20____.</p> <p>BY THE WEBER COUNTY COUNCIL _____</p> <p>COUNTY RECORDER COUNTY MAYOR</p>	<h4>SHEET 1 OF 1</h4> <p>PROJECT NUMBER : 9872 MANAGER : C.PRESTON DRAWN BY : J.MOSS CHECKED BY : T.WILLIAMS DATE : 11/13/2023</p>	<h4>WEBER COUNTY RECORDER</h4> <p>ENTRY NO. _____ FEE _____ PAID _____ FILED FOR RECORD AND RECORDED THIS _____ DAY OF _____, 20____. AT _____ IN BOOK _____ OF OFFICIAL RECORDS PAGE _____</p> <p>WEBER COUNTY RECORDER BY _____ DEPUTY RECORDER</p>
---	---	--	---	--	--	---

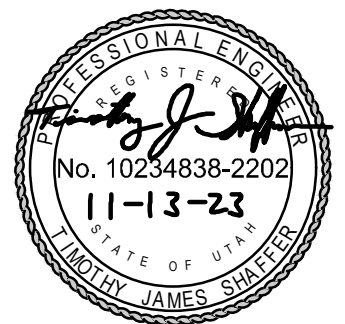

NO.	DATE	REVISION
		FOR REVIEW

GENERAL NOTES

PROJECT NUMBER	PRINT DATE
9872	2023-11-13
PROJECT MANAGER	DESIGNED BY
CP	TS

GENERAL NOTES

- ALL CONSTRUCTION MUST STRICTLY FOLLOW THE STANDARDS AND SPECIFICATIONS SET FORTH BY: THE DESIGN ENGINEER, LOCAL AGENCY JURISDICTION, APWA (CURRENT EDITION), AND THE MANUAL ON UNIFORM TRAFFIC CONTROL DEVICES (M.U.T.C.D.). THE ORDER LISTED ABOVE IS ARRANGED BY SENIORITY. THE LATEST EDITION OF ALL STANDARDS AND SPECIFICATIONS MUST BE ADHERED TO. IF A CONSTRUCTION PRACTICE IS NOT SPECIFIED BY ANY OF THE LISTED SOURCES, CONTRACTOR MUST CONTACT DESIGN ENGINEER FOR DIRECTION.
- CONTRACTOR TO STRICTLY FOLLOW THE MOST CURRENT COPY OF THE SOILS REPORT FOR THIS PROJECT. ALL GRADING INCLUDING BUT NOT LIMITED TO CUT, FILL, COMPACTION, ASPHALT SECTION, SUBBASE, TRENCH EXCAVATION/BACKFILL, SITE GRUBBING, AND FOOTINGS MUST BE COORDINATED DIRECTLY WITH SOILS REPORT.
- CONTRACTOR MUST VERIFY ALL EXISTING CONDITIONS BEFORE BIDDING, AND BRING UP ANY QUESTIONS BEFORE SUBMITTING BID.
- CONTRACTOR SHALL PROVIDE A CONSTRUCTION SCHEDULE IN ACCORDANCE WITH THE CITY, STATE, OR COUNTY REGULATIONS FOR WORKING IN THE PUBLIC WAY.
- CONTRACTOR SHALL BE RESPONSIBLE FOR DUST CONTROL ACCORDING TO GOVERNING AGENCY STANDARDS. WET DOWN DRY MATERIALS AND RUBBISH TO PREVENT BLOWING.
- CONTRACTOR SHALL BE RESPONSIBLE FOR ANY DAMAGE TO ADJACENT SURFACE IMPROVEMENTS.
- CONTRACTOR SHALL BE RESPONSIBLE FOR CORRECTING ANY SETTLEMENT OF OR DAMAGE TO EXISTING UTILITIES.
- THE CONTRACTOR IS RESPONSIBLE TO FURNISH ALL MATERIALS TO COMPLETE THE PROJECT.
- ALL EXPOSED SURFACES WILL HAVE A TEXTURED FINISH, RUBBED, OR BROOMED. ANY "PLASTERING" OF NEW CONCRETE WILL BE DONE WHILE IT IS STILL "GREEN".
- PRIOR TO STARTING CONSTRUCTION, THE CONTRACTOR SHALL BE RESPONSIBLE FOR VERIFYING THAT ALL REQUIRED PERMITS AND APPROVALS HAVE BEEN OBTAINED. NO CONSTRUCTION OR FABRICATION SHALL BEGIN UNTIL THE CONTRACTOR HAS RECEIVED AND THOROUGHLY REVIEWED ALL PLANS AND OTHER DOCUMENTS APPROVED BY ALL OF THE PERMITTING AUTHORITIES.
- THE LOCATIONS OF UNDERGROUND FACILITIES SHOWN ON THESE PLANS ARE BASED ON FIELD SURVEYS AND LOCAL UTILITY COMPANY RECORDS. IT SHALL BE THE CONTRACTOR'S FULL RESPONSIBILITY TO CONTACT THE VARIOUS UTILITY COMPANIES TO LOCATE THEIR FACILITIES PRIOR TO PROCEEDING WITH CONSTRUCTION. NO ADDITIONAL COMPENSATION SHALL BE PAID TO THE CONTRACTOR FOR DAMAGE AND REPAIR TO THESE FACILITIES CAUSED BY HIS WORK FORCE. CONTRACTOR SHALL START INSTALLATION AT LOW POINT OF ALL NEW GRAVITY UTILITY LINES.
- ALL DIMENSIONS, GRADES, AND UTILITY DESIGN SHOWN ON THE PLANS SHALL BE VERIFIED BY THE CONTRACTOR PRIOR TO CONSTRUCTION. CONTRACTOR SHALL NOTIFY THE ENGINEER IF ANY DISCREPANCIES EXIST. PRIOR TO PROCEEDING WITH CONSTRUCTION FOR NECESSARY PLAN OR GRADE CHANGES, NO EXTRA COMPENSATION SHALL BE PAID TO THE CONTRACTOR FOR WORK HAVING TO DO WITH THE DIMENSIONS OR GRADES SHOWN INCORRECTLY ON THESE PLANS, IF SUCH NOTIFICATION HAS NOT BEEN GIVEN.
- NO CHANGE IN DESIGN LOCATION OR GRADE WILL BE MADE BY THE CONTRACTOR WITHOUT THE WRITTEN APPROVAL OF THE PROJECT ENGINEER.
- NATURAL VEGETATION AND SOIL COVER SHALL NOT BE DISTURBED PRIOR TO ACTUAL CONSTRUCTION OF A REQUIRED FACILITY OR IMPROVEMENT. MASS CLEARING OF THE SITE IN ANTICIPATION OF CONSTRUCTION SHALL BE AVOIDED.
- CONTRACTOR SHALL BE RESPONSIBLE FOR FURNISHING, MAINTAINING, OR RESTORING ALL MONUMENTS AND MONUMENT REFERENCE MARKS WITHIN THE PROJECT SITE. CONTACT THE CITY OR COUNTY SURVEYOR FOR MONUMENT LOCATIONS AND CONSTRUCTION DETAILS.
- EXISTING UTILITY INFORMATION SHOWN IS FOR INFORMATIONAL PURPOSES ONLY. IT IS DERIVED FROM ON-SITE SURVEY AND/OR UTILITY MAPS PROVIDED TO THE ENGINEER, AND THEREFORE UTILITIES MAY NOT BE LOCATED CORRECTLY, EITHER HORIZONTALLY OR VERTICALLY, AND MAY NOT BE ALL INCLUSIVE. CONTRACTOR IS REQUIRED TO FOLLOW THE PROCEDURE OUTLINED BELOW:
 - CONTRACTOR IS REQUIRED TO LOCATE AND POTHOLE ALL EXISTING UTILITY LINES (BOTH HORIZONTALLY AND VERTICALLY) THAT AFFECT THE PROJECT CONSTRUCTION, EITHER ON-SITE OR OFF-SITE, AND DETERMINE IF THERE ARE ANY CONFLICTS WITH THE DESIGN OF THE SITE AS SHOWN ON THE APPROVED PLANS PRIOR TO ANY CONSTRUCTION. IF IT IS DETERMINED THAT CONFLICTS EXIST BETWEEN EXISTING UTILITIES AND DESIGN UTILITIES (OR ANOTHER ASPECT OF PROPOSED CONSTRUCTION) THE ENGINEER MUST BE NOTIFIED IMMEDIATELY TO CORRECT THE CONFLICTS BEFORE ANY WORK CAN BEGIN. IF THE CONTRACTOR FAILS TO FOLLOW THIS ABSOLUTE REQUIREMENT AND CONFLICTS ARISE DURING CONSTRUCTION THE CONTRACTOR WILL BEAR THE SOLE RESPONSIBILITY TO FIX THE CONFLICTS.
 - CONTRACTOR IS REQUIRED TO VERIFY THAT PROPER COVER AND PROTECTION OF EXISTING UTILITY LINES IS MAINTAINED OR ATTAINED WITHIN THE DESIGN ONCE VERIFICATION OF THE EXISTING UTILITIES IS COMPLETED AS OUTLINED IN 16.1 ABOVE. IN ADDITION TO 16.1 AND 16.2 ABOVE THE CONTRACTOR WILL VERIFY DEPTHS OF UTILITIES IN THE FIELD BY "POTHOLES" A MINIMUM OF 300 FEET AHEAD OF PROPOSED PIPELINE CONSTRUCTION TO AVOID POTENTIAL CONFLICTS WITH DESIGNER PIPELINE ALIGNMENT AND GRADE AND EXISTING UTILITIES.
 - IF A CONFLICT ARISES BETWEEN EXISTING UTILITIES AND DESIGN UTILITIES (OR ANOTHER ASPECT OF PROPOSED CONSTRUCTION) AS DETERMINED UNDER 16.1, 16.2 OR 16.3 THE CONTRACTOR WILL NOTIFY THE ENGINEER IMMEDIATELY TO RESOLVE THE CONFLICT.
 - IF A CONFLICT ARISES BETWEEN EXISTING UTILITIES AND DESIGN UTILITIES (OR ANOTHER ASPECT OF PROPOSED CONSTRUCTION) RESULTING FROM THE CONTRACTOR'S NEGLIGENCE TO IDENTIFY AND/OR "POTHOLE" EXISTING UTILITIES AS REQUIRED IN 16.1, 16.2 AND 16.3 ABOVE, THE CONTRACTOR WILL BE REQUIRED TO RESOLVE THE CONFLICT WITHOUT ADDITIONAL COST OR CLAIM TO THE OWNER OR ENGINEER.
- ANY AREA OUTSIDE THE LIMIT OF WORK THAT IS DISTURBED SHALL BE RESTORED TO ITS ORIGINAL CONDITION AT NO COST TO OWNER.
- CONSULT ALL OF THE DRAWINGS AND SPECIFICATIONS FOR COORDINATION REQUIREMENTS BEFORE COMMENCING CONSTRUCTION.
- AT ALL LOCATIONS WHERE EXISTING PAVEMENT ADJUTS NEW CONSTRUCTION, THE EDGE OF THE EXISTING PAVEMENT SHALL BE SAWCUT TO A CLEAN, SMOOTH EDGE.
- ALL CONSTRUCTION AND MATERIALS SHALL BE IN ACCORDANCE WITH THE MOST RECENT, ADOPTED EDITION OF ADA ACCESSIBILITY GUIDELINES.
- CONTRACTOR SHALL, AT THE TIME OF BIDDING AND THROUGHOUT THE PERIOD OF THE CONTRACT, BE LICENSED IN THE STATE OF UTAH AND SHALL BE BONDABLE FOR AN AMOUNT REQUIRED BY THE OWNER.
- CONTRACTOR SHALL BE RESPONSIBLE TO PROVIDE ALL WATER, POWER, SANITARY FACILITIES AND TELEPHONE SERVICES AS REQUIRED FOR THE CONTRACTOR'S USE DURING CONSTRUCTION.
- CONTRACTOR SHALL BE RESPONSIBLE FOR ADEQUATELY SCHEDULING INSPECTION AND TESTING OF ALL FACILITIES CONSTRUCTED UNDER THIS CONTRACT. ALL TESTING SHALL CONFORM TO THE REGULATORY AGENCY'S STANDARD SPECIFICATIONS. ALL RE-TESTING AND/OR RE-INSPECTION SHALL BE PAID FOR BY THE CONTRACTOR.
- IF EXISTING IMPROVEMENTS NEED TO BE DISTURBED AND/OR REMOVED FOR THE PROPER PLACEMENT OF IMPROVEMENTS TO BE CONSTRUCTED BY THESE PLANS, THE CONTRACTOR SHALL BE RESPONSIBLE FOR PROTECTING EXISTING IMPROVEMENTS FROM DAMAGE. COST OF REPLACING OR REPAIRING EXISTING IMPROVEMENTS SHALL BE INCLUDED IN THE UNIT PRICE BID FOR ITEMS REQUIRING REMOVAL AND/OR REPLACEMENT. THERE WILL BE NO EXTRA COST DUE TO THE CONTRACTOR FOR REPLACING OR REPAIRING EXISTING IMPROVEMENTS.
- WHENEVER EXISTING FACILITIES ARE REMOVED, DAMAGED, BROKEN, OR CUT IN THE INSTALLATION OF THE WORK COVERED BY THESE PLANS OR SPECIFICATIONS, SAID FACILITIES SHALL BE REPLACED AT THE CONTRACTOR'S EXPENSE WITH MATERIALS EQUAL TO OR BETTER THAN THE MATERIALS USED IN THE ORIGINAL EXISTING FACILITIES. THE FINISHED PRODUCT SHALL BE SUBJECT TO THE APPROVAL OF THE OWNER, THE ENGINEER, AND THE RESPECTIVE REGULATORY AGENCY.
- CONTRACTOR SHALL MAINTAIN A NEATLY MARKED SET OF FULL-SIZE RECORD DRAWINGS SHOWING THE FINAL LOCATION AND LAYOUT OF ALL STRUCTURES AND OTHER FACILITIES. RECORD DRAWINGS SHALL REFLECT CHANGE ORDERS, ACCOMMODATIONS, AND ADJUSTMENTS TO ALL IMPROVEMENTS CONSTRUCTED. WHERE NECESSARY, SUPPLEMENTAL DRAWINGS SHALL BE PREPARED AND SUBMITTED BY THE CONTRACTOR. PRIOR TO ACCEPTANCE OF THE PROJECT, THE CONTRACTOR SHALL DELIVER TO THE ENGINEER ONE SET OF NEATLY MARKED RECORD DRAWINGS SHOWING THE INFORMATION REQUIRED ABOVE. RECORD DRAWINGS SHALL BE REVIEWED AND THE COMPLETE RECORD DRAWINGS SET SHALL BE CURRENT WITH ALL CHANGES AND DEVIATIONS REDLINED AS A PRECONDITION TO THE FINAL PROGRESS PAYMENT APPROVAL AND/OR FINAL ACCEPTANCE.
- WHERE THE PLANS OR SPECIFICATIONS DESCRIBE PORTIONS OF THE WORK IN GENERAL TERMS BUT NOT IN COMPLETE DETAIL, IT IS UNDERSTOOD THAT ONLY THE BEST GENERAL PRACTICE IS TO PREVAIL AND THAT ONLY MATERIALS AND WORKMANSHIP OF THE FIRST QUALITY ARE TO BE USED.
- ALL EXISTING GATES AND FENCES TO REMAIN UNLESS OTHERWISE NOTED ON PLANS. PROTECT ALL GATES AND FENCES FROM DAMAGE.
- ALL EXISTING TREES ARE TO REMAIN UNLESS OTHERWISE NOTED ON PLANS. PROTECT ALL TREES FROM DAMAGE.
- ASPHALT MIX DESIGN MUST BE SUBMITTED AND APPROVED BY THE GOVERNING AGENCY PRIOR TO THE PLACEMENT.
- CONTRACTORS ARE RESPONSIBLE FOR ALL OSHA REQUIREMENTS ON THE PROJECT SITE.
- A UPDES (UTAH POLLUTANT DISCHARGE ELIMINATION SYSTEM) PERMIT IS REQUIRED FOR ALL CONSTRUCTION ACTIVITIES 1 ACRE OR MORE AS WELL AS A STORM WATER POLLUTION PREVENTION PLAN.

UTILITY NOTES

- ALL CONSTRUCTION AND MATERIALS SHALL BE IN ACCORDANCE WITH THESE CONTRACT DOCUMENTS, CITY AND STATE REQUIREMENTS AND THE MOST RECENT EDITIONS OF THE FOLLOWING: THE INTERNATIONAL PLUMBING CODE, UTAH DRINKING WATER REGULATIONS, APWA MANUAL OF STANDARD PLANS AND SPECIFICATIONS. THE CONTRACTOR IS REQUIRED TO ADHERE TO ALL OF THE ABOVE-MENTIONED DOCUMENTS UNLESS OTHERWISE NOTED AND APPROVED BY THE ENGINEER.
- CONTRACTOR SHALL COORDINATE LOCATION OF NEW "DRY UTILITIES" WITH THE APPROPRIATE UTILITY COMPANY, INCLUDING BUT NOT LIMITED TO: TELEPHONE & INTERNET SERVICE, GAS SERVICE, CABLE, AND POWER.
- EXISTING UTILITIES HAVE BEEN SHOWN ON THE PLANS BASED ON ON-SITE SURVEY. PRIOR TO COMMENCING ANY WORK, IT SHALL BE THE CONTRACTOR'S RESPONSIBILITY TO HAVE EACH UTILITY COMPANY LOCATE, IN THE FIELD, THEIR MAIN AND SERVICE LINES. THE CONTRACTOR SHALL NOTIFY BLUE STAKES AT 1-800-462-4111 48 HOURS IN ADVANCE OF PERFORMING ANY EXCAVATION WORK. THE CONTRACTOR SHALL RECORD THE BLUE STAKES ORDER NUMBER AND FURNISH ORDER NUMBER TO OWNER AND ENGINEER PRIOR TO ANY EXCAVATION. IT WILL BE THE CONTRACTOR'S SOLE RESPONSIBILITY TO DIRECTLY CONTACT ANY OTHER UTILITY COMPANIES THAT ARE NOT MEMBERS OF BLUE STAKES. IT SHALL BE THE CONTRACTOR'S SOLE RESPONSIBILITY TO PROTECT ALL EXISTING UTILITIES SO THAT NO DAMAGE RESULTS TO THEM DURING THE PERFORMANCE OF THIS CONTRACT. ANY REPAIRS NECESSARY TO DAMAGED UTILITIES SHALL BE PAID FOR BY THE CONTRACTOR. THE CONTRACTOR SHALL BE REQUIRED TO COOPERATE WITH OTHER CONTRACTORS AND UTILITY COMPANIES INSTALLING NEW STRUCTURES, UTILITIES AND SERVICE TO THE PROJECT.
- CARE SHOULD BE TAKEN IN ALL EXCAVATIONS DUE TO POSSIBLE EXISTENCE OF UNRECORDED UTILITY LINES. EXCAVATION REQUIRED WITHIN PROXIMITY OF EXISTING UTILITY LINES SHALL BE DONE BY HAND. CONTRACTOR SHALL REPAIR ANY DAMAGE TO EXISTING UTILITY LINES OR STRUCTURES INCURRED DURING CONSTRUCTION OPERATIONS AT CONTRACTOR'S EXPENSE.
- TRENCH BACKFILL MATERIAL AND COMPACTION TESTS ARE TO BE TAKEN PER APWA STANDARD SPECIFICATIONS (CURRENT EDITION), SECTION 3035 20 - BACKFILLING TRENCHES, OR AS REQUIRED BY THE GEOTECHNICAL REPORT IF NATIVE MATERIALS ARE USED. NO NATIVE MATERIALS ARE ALLOWED IN THE PIPE ZONE. THE MAXIMUM LIFT FOR BACKFILLING EXCAVATIONS IS DETERMINED BY THE GEOTECHNICAL RECOMMENDATIONS.
- THE CONTRACTOR IS SOLELY RESPONSIBLE FOR CONFORMING TO LOCAL AND FEDERAL CODES GOVERNING SHORING AND BRACING OF EXCAVATIONS AND TRENCHES AND FOR THE PROTECTION OF WORKERS.
- THE CONTRACTOR IS REQUIRED TO KEEP ALL CONSTRUCTION ACTIVITIES WITHIN THE APPROVED PROJECT LIMITS. THIS INCLUDES, BUT IS NOT LIMITED TO VEHICLE AND EQUIPMENT STAGING, MATERIAL STORAGE AND LIMITS OF TRENCH EXCAVATION. IT IS THE CONTRACTOR'S RESPONSIBILITY TO OBTAIN PERMISSION AND/OR EASEMENTS FROM THE APPROPRIATE GOVERNING ENTITY AND/OR INDIVIDUAL PROPERTY OWNER(S) FOR WORK OR STAGING OUTSIDE OF THE PROJECT LIMITS.
- THE CONTRACTOR IS RESPONSIBLE FOR REPAIRING ANY DAMAGE, CAUSED BY ANY CONDITION INCLUDING SETTLEMENT, TO EXISTING UTILITIES FROM WORK PERFORMED AT OR NEAR EXISTING UTILITIES. THE CONTRACTOR SHALL TAKE ALL MEASURES NECESSARY TO PROTECT ALL EXISTING PUBLIC AND PRIVATE ROADWAY AND UTILITY FACILITIES. DAMAGE TO EXISTING FACILITIES CAUSED BY THE CONTRACTOR MUST BE REPAIRED BY THE CONTRACTOR AT HISHER EXPENSE TO THE SATISFACTION OF THE OWNER OF SAID FACILITIES.
- ALL WATER LINE AND SEWER LINE INSTALLATION AND TESTING TO BE IN ACCORDANCE WITH LOCAL GOVERNING AGENCY'S STANDARDS AND SPECIFICATIONS.
- ALL MANHOLES, HYDRANTS, VALVES, CLEANOUT BOXES, CATCH BASINS, METERS, ETC. MUST BE RAISED OR LOWERED TO FINAL GRADE PER APWA (CURRENT EDITION) STANDARDS AND INSPECTOR REQUIREMENTS. CONCRETE COLLARS MUST BE CONSTRUCTED ON ALL MANHOLES, CLEANOUT BOXES, CATCH BASINS, PER APWA STANDARDS. ALL MANHOLE, CATCH BASIN, OR CLEANOUT BOX CONNECTIONS MUST BE MADE WITH THE PIPE CUT FLUSH WITH THE INSIDE OF THE BOX AND GROUTED OR SEALED.
- CONTRACTOR SHALL NOT ALLOW ANY GROUNDWATER OR DEBRIS TO ENTER THE NEW OR EXISTING PIPE DURING CONSTRUCTION.
- SILT AND DEBRIS ARE TO BE CLEANED OUT OF ALL STORM DRAIN BOXES. CATCH BASINS ARE TO BE MAINTAINED IN A CLEANED CONDITION AS NEEDED UNTIL AFTER THE FINAL BOND RELEASE INSPECTION.
- CONTRACTOR SHALL CLEAN ASPHALT, TAR OR OTHER ADHESIVES OFF OF ALL MANHOLE LIDS AND INLET GRATES TO ALLOW ACCESS.
- EACH TRENCH SHALL BE EXCAVATED SO THAT THE PIPE CAN BE LAID TO THE ALIGNMENT AND GRADE AS REQUIRED. THE TRENCH WALL SHALL BE SO BRACED THAT THE WORKMEN MAY WORK SAFELY AND EFFICIENTLY. ALL TRENCHES SHALL BE DRAINED SO THE PIPE LAYING MAY TAKE PLACE IN DEWATERED CONDITIONS.
- CONTRACTOR SHALL PROVIDE AND MAINTAIN AT ALL TIMES AMPLE MEANS AND DEVICES WITH WHICH TO REMOVE PROMPTLY AND TO PROPERLY DISPOSE OF ALL WATER ENTERING THE TRENCH EXCAVATION.
- ALL SEWER LINES AND SEWER SERVICES SHALL HAVE A MINIMUM SEPARATION OF 10 FEET, EDGE TO EDGE, FROM THE WATER LINES. IF A 10 FOOT SEPARATION CAN NOT BE MAINTAINED, CONSTRUCT PER GOVERNING AGENCY'S MINIMUM SEPARATION STANDARDS.
- CONTRACTOR SHALL INSTALL THRUST BLOCKING AT ALL WATERLINE ANGLE POINTS AND TEES.
- ALL UNDERGROUND UTILITIES SHALL BE IN PLACE PRIOR TO INSTALLATION OF CURB, GUTTER, SIDEWALK AND STREET PAVING.
- CONTRACTOR SHALL INSTALL MAGNETIC LOCATING TAPE CONTINUOUSLY OVER ALL NONMETALLIC PIPE.

TRAFFIC CONTROL AND SAFETY NOTES

- TRAFFIC CONTROL AND STRIPINGS TO CONFORM TO THE CURRENT MANUAL OF UNIFORM TRAFFIC CONTROL DEVICES (M.U.T.C.D.).
- BARRICADING AND DETOURING SHALL BE IN CONFORMANCE WITH THE REQUIREMENTS OF THE CURRENT M.U.T.C.D.
- NO STREET SHALL BE CLOSED TO TRAFFIC WITHOUT WRITTEN PERMISSION FROM THE APPROPRIATE AGENCY, EXCEPT WHEN DIRECTED BY LAW ENFORCEMENT OR FIRE OFFICIALS.
- THE CONTRACTOR SHALL MAKE EVERY EFFORT TO PROVIDE FOR SMOOTH TRAFFIC FLOW AND SAFETY. ACCESS SHALL BE MAINTAINED FOR ALL PROPERTIES ADJACENT TO THE WORK.
- DETOURING OPERATIONS FOR A PERIOD OF SIX CONSECUTIVE CALENDAR DAYS, OR MORE, REQUIRE THE INSTALLATION OF TEMPORARY STREET STRIPING AND REMOVAL OF INTERFERING STRIPING BY SANDBLASTING. THE DETOURING STRIPING PLAN OR CONSTRUCTION TRAFFIC CONTROL PLAN MUST BE SUBMITTED TO THE GOVERNING AGENCY FOR REVIEW AND APPROVAL.
- ALL TRAFFIC CONTROL DEVICES SHALL BE RESTORED TO THEIR ORIGINAL CONDITION AT THE END OF THE WORK TO THE SATISFACTION OF THE GOVERNING AGENCY.
- TRAFFIC CONTROL DEVICES (TCDs) SHALL REMAIN VISIBLE AND OPERATIONAL AT ALL TIMES.
- ALL PERMANENT TRAFFIC CONTROL DEVICES CALLED FOR HEREON SHALL BE IN PLACE AND IN FINAL POSITION PRIOR TO ALLOWING ANY PUBLIC TRAFFIC ONTO THE PORTIONS OF THE ROAD(S) BEING IMPROVED HEREUNDER, REGARDLESS OF THE STATUS OF COMPLETION OF PAVING OR OTHER OFF-SITE IMPROVEMENTS CALLED FOR BY THESE PLANS.
- THE CONTRACTOR SHALL PROVIDE BARRICADES, SIGNS, FLASHERS, OTHER EQUIPMENT AND FLAG PERSONS NECESSARY TO INSURE THE SAFETY OF WORKERS AND VISITORS.
- THE CONTRACTOR SHALL BE RESPONSIBLE FOR NOTIFYING UTAH TRANSIT AUTHORITY (UTA) IF THE CONSTRUCTION INTERRUPTS OR RELOCATES A BUS STOP OR HAS AN ADVERSE EFFECT ON BUS SERVICE ON THAT STREET TO ARRANGE FOR TEMPORARY RELOCATION OF A STOP.

DEMOLITION NOTES

- EXISTING UTILITY INFORMATION SHOWN IS FOR INFORMATIONAL PURPOSES ONLY. IT IS DERIVED FROM ON-SITE SURVEY AND MAY NOT BE LOCATED CORRECTLY AND IS NOT ALL INCLUSIVE. CONTRACTOR SHALL FIELD LOCATE ALL UTILITIES WITHIN THE PROJECT LIMITS BEFORE BEGINNING DEMOLITION/CONSTRUCTION.
- THERE MAY BE BURIED UTILITIES WITHIN THE LIMITS OF DISTURBANCE THAT ARE NOT SHOWN ON THE PLANS DUE TO LACK OF MAPPING OR RECORD INFORMATION. CONTRACTOR SHALL NOTIFY THE ENGINEER WHEN UNEXPECTED UTILITIES ARE DISCOVERED.
- THE CONTRACTOR SHALL BE FULLY RESPONSIBLE FOR LOCATING AND PROTECTING FROM DAMAGE ALL EXISTING UTILITIES AND IMPROVEMENTS WHETHER OR NOT SHOWN ON THESE PLANS. THE FACILITIES AND IMPROVEMENTS ARE BELIEVED TO BE CORRECTLY SHOWN BUT THE CONTRACTOR IS REQUIRED TO SATISFY HIMSELF AS TO THE COMPLETENESS AND ACCURACY OF THE LOCATIONS. ANY CONTRACTOR PERFORMING WORK ON THIS PROJECT SHALL FAMILIARIZE HIMSELF WITH THE SITE AND SHALL BE HELD SOLELY RESPONSIBLE FOR ANY DAMAGE TO EXISTING FACILITIES RESULTING DIRECTLY, OR INDIRECTLY, FROM HIS OPERATIONS, WHETHER OR NOT SAID FACILITIES ARE SHOWN ON THESE PLANS.

GRADING AND DRAINAGE NOTES

- SITE GRADING SHALL BE PERFORMED IN ACCORDANCE WITH THESE PLANS AND SPECIFICATIONS AND THE RECOMMENDATIONS SET FORTH IN THE GEOTECHNICAL REPORT AND ALL RELATED ADDENDUMS.
- THE CONTRACTOR SHALL STRIP AND CLEAR THE TOPSOIL, MAJOR ROOTS AND ORGANIC MATERIAL FROM ALL PROPOSED BUILDING AND PAVEMENT AREAS PRIOR TO SITE GRADING. (THE TOPSOIL MAY BE STOCKPILED FOR LATER USE IN LANDSCAPED AREAS.)
- THE CONTRACTOR SHALL REMOVE ALL ORGANIC MATERIAL AND OTHER DELETERIOUS MATERIALS PRIOR TO PLACING GRADING FILL OR BASE COURSE. THE AREA SHOULD BE PROOF-ROLLED TO IDENTIFY ANY SOFT AREAS. WHERE SOFT AREAS ARE ENCOUNTERED, THE CONTRACTOR SHALL REMOVE THE SOIL AND REPLACE WITH COMPACTED FILL.
- ALL DEBRIS PILES AND BERMS SHOULD BE REMOVED AND HAULED AWAY FROM SITE OR USED AS GENERAL FILL IN LANDSCAPED AREAS.
- THE CONTRACTOR SHALL CONSTRUCT THE BUILDING PAD TO THESE DESIGN PLANS AS PART OF THE SITE GRADING CONTRACT, AND STRICTLY ADHERE TO THE SITE PREPARATION AND GRADING REQUIREMENTS OUTLINED IN THE GEOTECHNICAL REPORT.
- THE CONTRACTOR SHALL GRADE THE PROJECT SITE TO PROVIDE A SMOOTH TRANSITION BETWEEN NEW AND EXISTING ASPHALT, CURB AND GUTTER, AND ADJOINING SITE IMPROVEMENTS.
- THE CONTRACTOR SHALL BE RESPONSIBLE FOR DAMAGE AND DEBRIS ON ADJACENT STREETS WHEN EQUIPMENT IS TRAVELING THOSE STREETS.
- THE CONTRACTOR SHALL BE FAMILIAR WITH ALL CONDITIONS AND RECOMMENDATIONS OUTLINED IN THE GEOTECHNICAL REPORT AND TAKE ALL NECESSARY PRECAUTIONS AND RECOMMENDED PROCEDURES TO ASSURE SOUND GRADING PRACTICES.
- THE CONTRACTOR SHALL TAKE APPROPRIATE GRADING MEASURES TO DIRECT STORM SURFACE RUNOFF TOWARDS CATCH BASINS.
- THE LOCATIONS OF UNDERGROUND FACILITIES SHOWN ON THESE PLANS ARE BASED ON ON-SITE SURVEY. IT SHALL BE THE CONTRACTOR'S FULL RESPONSIBILITY TO CONTACT THE VARIOUS UTILITY COMPANIES TO LOCATE THEIR FACILITIES PRIOR TO PROCEEDING WITH CONSTRUCTION. NO ADDITIONAL COMPENSATION SHALL BE PAID TO THE CONTRACTOR FOR DAMAGE AND REPAIR TO THESE FACILITIES CAUSED BY HIS WORK FORCE.
- IT SHALL BE THE RESPONSIBILITY OF THE CONTRACTOR TO PERFORM ALL NECESSARY CUTS AND FILLS WITHIN THE LIMITS OF THIS PROJECT AND THE RELATED OFF-SITE WORK, SO AS TO GENERATE THE DESIRED SUBGRADE, FINISH GRADES, AND SLOPES SHOWN.
- THE CONTRACTOR IS WARNED THAT AN EARTHWORK BALANCE WAS NOT NECESSARILY THE INTENT OF THIS PROJECT. ANY ADDITIONAL MATERIAL REQUIRED OR LEFTOVER MATERIAL FOLLOWING EARTHWORK OPERATIONS BECOMES THE RESPONSIBILITY OF THE CONTRACTOR.
- THE GRADING CONTRACTOR IS RESPONSIBLE TO COORDINATE WITH THE OWNER TO PROVIDE FOR THE REQUIREMENTS OF THE PROJECT STORM WATER POLLUTION PREVENTION PLAN (SWPPP) AND ASSOCIATED PERMIT. ALL CONTRACTOR ACTIVITIES 1 ACRE OR MORE IN SIZE ARE REQUIRED TO PROVIDE A STORM WATER POLLUTION PREVENTION PLAN.
- ALL CUT AND FILL SLOPES SHALL BE PROTECTED UNTIL EFFECTIVE EROSION CONTROL HAS BEEN ESTABLISHED.
- THE USE OF POTABLE WATER WITHOUT A SPECIAL PERMIT FOR BUILDING OR CONSTRUCTION PURPOSES INCLUDING CONSOLIDATION OF BACKFILL OR DUST CONTROL IS PROHIBITED. THE CONTRACTOR SHALL OBTAIN ALL NECESSARY PERMITS FOR CONSTRUCTION WATER FROM GOVERNING AGENCY.
- THE CONTRACTOR SHALL MAINTAIN THE STREETS, SIDEWALKS, AND ALL OTHER PUBLIC RIGHT-OF-WAYS IN A CLEAN, SAFE AND USABLE CONDITION. ALL SPILLS OF SOIL, ROCK OR CONSTRUCTION DEBRIS SHALL BE PROMPTLY REMOVED FROM THE PUBLICLY-OWNED PROPERTY DURING CONSTRUCTION AND UPON COMPLETION OF THE PROJECT. ALL ADJACENT PROPERTY, PRIVATE OR PUBLIC, SHALL BE MAINTAINED IN A CLEAN, SAFE, AND USABLE CONDITION.

ABBREVIATIONS

APWA	AMERICAN PUBLIC WORKS ASSOCIATION
AR	ACCESSIBLE ROUTE
ASTM	AMERICAN SOCIETY FOR TESTING AND MATERIALS
AWWA	AMERICAN WATER WORKS ASSOCIATION
BOS	BOTTOM OF STEP
BVC	BEGIN VERTICAL CURVE
C	CURVE
CB	CATCH BASIN
CF	CURB FACE OR CURB FEET
CL	CENTER LINE
CO	CLEAN OUT
COMM	COMMUNICATION
CONC	CONCRETE
CONT	CONTINUOUS
DIA	DIAMETER
DIP	DUCTILE IRON PIPE
ELEC	ELECTRICAL
ELEV	ELEVATION
EOA	EDGE OF ASPHALT
EVC	END OF VERTICAL CURVE
EW	EACH WAY
EXIST	EXISTING
FF	FINISH FLOOR
FG	FINISH GRADE
FH	FIRE HYDRANT
FL	FLOW LINE OR FLANGE
GB	GRADE BREAK
GF	GARAGE FLOOR
GV	GATE VALVE
HC	HANDICAP
HP	HIGH POINT
IRR	IRRIGATION
K	RATE OF VERTICAL CURVATURE
LD	LAND DRAIN
LF	LINEAR FEET
LP	LOW POINT
MEX	MATCH EXISTING
MH	MANHOLE
MJ	MECHANICAL JOINT
NG	NATURAL GROUND
NIC	NOT IN CONTRACT
NO	NUMBER
ON	ON CENTER
OCEW	ON CENTER EACH WAY
OP	OVERHEAD POWER
PC	POINT OF CURVATURE OR PRESSURE CLASS
PCC	POINT OF COMPOUND CURVATURE
PI	POINT OF INTERSECTION
PV	POST INDICATOR VALVE
PVL	PROPERTY LINE
PRC	POINT OF REVERSE CURVATURE
PRO	PROPOSED
PT	POINT OF TANGENCY
PVC	POINT OF VERTICAL CURVATURE
PVI	POINT OF VERTICAL INTERSECTION
PVT	POINT OF VERTICAL TANGENCY
R	RADIUS
RD	ROCK DRAIN
ROW	RIGHT OF WAY
S	SLOPE
SAN SWR	SANITARY SEWER
SD	STORM DRAIN
SEC	SECONDARY
SS	SANITARY SEWER
STA	STATION
SW	SECONDARY WATER LINE
TBC	TOP BACK OF CURB
TOG	TOP OF GRATE
TOA	TOP OF ASPHALT
TCC	TOP OF CONCRETE
TOF	TOP OF FOUNDATION
TOW	TOP OF WALL
TOS	TOP OF STEP
TYP	TYPICAL
VC	VERTICAL CURVE
WV	WALL INDICATOR VALVE
W	WATER LINE

NOTE: MAY CONTAIN ABBREVIATIONS THAT ARE NOT USED IN THIS PLAN SET.

LEGEND

	SECTION CORNER		EXISTING EDGE OF ASPHALT
	EXISTING MONUMENT		PROPOSED EDGE OF ASPHALT
	PROPOSED MONUMENT		EXISTING STRIPING
	EXISTING REBAR AND CAP		PROPOSED STRIPING
	SET ENSIGN REBAR AND CAP		EXISTING FENCE
	EXISTING WATER METER		PROPOSED FENCE
	EXISTING WATER METER		EXISTING FLOW LINE
	EXISTING WATER MANHOLE		EXISTING WATER MANHOLE
	PROPOSED WATER MANHOLE		GRADE BREAK
	EXISTING WATER BOX		EXISTING STORM DRAIN LINE
	EXISTING WATER VALVE		PROPOSED STORM DRAIN LINE
	EXISTING WATER VALVE		ROOF DRAIN LINE
	EXISTING FIRE HYDRANT		CATCHMENTS
	PROPOSED FIRE HYDRANT		HIGHWATER LINE
	PROPOSED FIRE DEPARTMENT CONNECTION		EXISTING SANITARY SEWER
	EXISTING SECONDARY WATER VALVE		PROPOSED SANITARY SEWER LINE
	PROPOSED SECONDARY WATER VALVE		PROPOSED SAN. SWR. SERVICE LINE
	EXISTING IRRIGATION BOX		EXISTING LAND DRAIN LINE
	EXISTING IRRIGATION VALVE		PROPOSED LAND DRAIN LINE
	PROPOSED IRRIGATION VALVE		PROPOSED LAND DRAIN SERVICE LINE
	EXISTING SANITARY SEWER MANHOLE		EXISTING CULINARY WATER LINE
	PROPOSED SANITARY SEWER MANHOLE		PROPOSED CULINARY WATER SERVICE LINE
	EXISTING SANITARY CLEAN OUT		EXISTING SECONDARY WATER LINE
	EXISTING STORM DRAIN CLEAN OUT BOX		PROPOSED STORM DRAIN CLEAN OUT BOX
	EXISTING STORM DRAIN INLET BOX		PROPOSED STORM DRAIN CLEAN OUT BOX
	EXISTING STORM DRAIN CATCH BASIN		PROPOSED STORM DRAIN CLEAN OUT BOX
	PROPOSED STORM DRAIN CATCH BASIN		EXISTING STORM DRAIN INLET BOX
	EXISTING STORM DRAIN COMBO BOX		EXISTING STORM DRAIN CATCH BASIN
	PROPOSED STORM DRAIN COMBO BOX		PROPOSED STORM DRAIN CATCH BASIN
	EXISTING STORM DRAIN CLEAN OUT		EXISTING STORM DRAIN COMBO BOX
	EXISTING STORM DRAIN CULVERT		EXISTING STORM DRAIN CLEAN OUT
	PROPOSED STORM DRAIN CULVERT		EXISTING STORM DRAIN CULVERT
	TEMPORARY SAG INLET PROTECTION		EXISTING STORM DRAIN CULVERT
	TEMPORARY IN-LINE INLET PROTECTION		SAW CUT LINE
	ROOF DRAIN		STRAW WATTLE
	EXISTING ELECTRICAL MANHOLE		TEMPORARY BERM
	EXISTING ELECTRICAL BOX		TEMPORARY SILT FENCE
	EXISTING TRANSFORMER		LIMITS OF DISTURBANCE
	EXISTING UTILITY POLE		EXISTING WALL
	EXISTING LIGHT		PROPOSED WALL
	PROPOSED LIGHT		EXISTING CONTOURS
	EXISTING GAS METER		PROPOSED CONTOURS
	EXISTING GAS MANHOLE		BUILDABLE AREA WITHIN SETBACKS
	EXISTING TELEPHONE MANHOLE		PUBLIC DRAINAGE EASEMENT
	EXISTING TELEPHONE BOX		EXISTING ASPHALT TO BE REMOVED
	EXISTING TRAFFIC SIGNAL BOX		PROPOSED ASPHALT
	EXISTING BOLLARD		EXISTING CURB AND GUTTER
	PROPOSED BOLLARD		

811
 Know what's below.
 Call before you dig.

BENCHMARK
 NORTHWEST CORNER OF SECTION 27
 TOWNSHIP 7 NORTH, RANGE 2 WEST
 SALT LAKE BASE AND MERIDIAN
 ELEV = 4231.00'

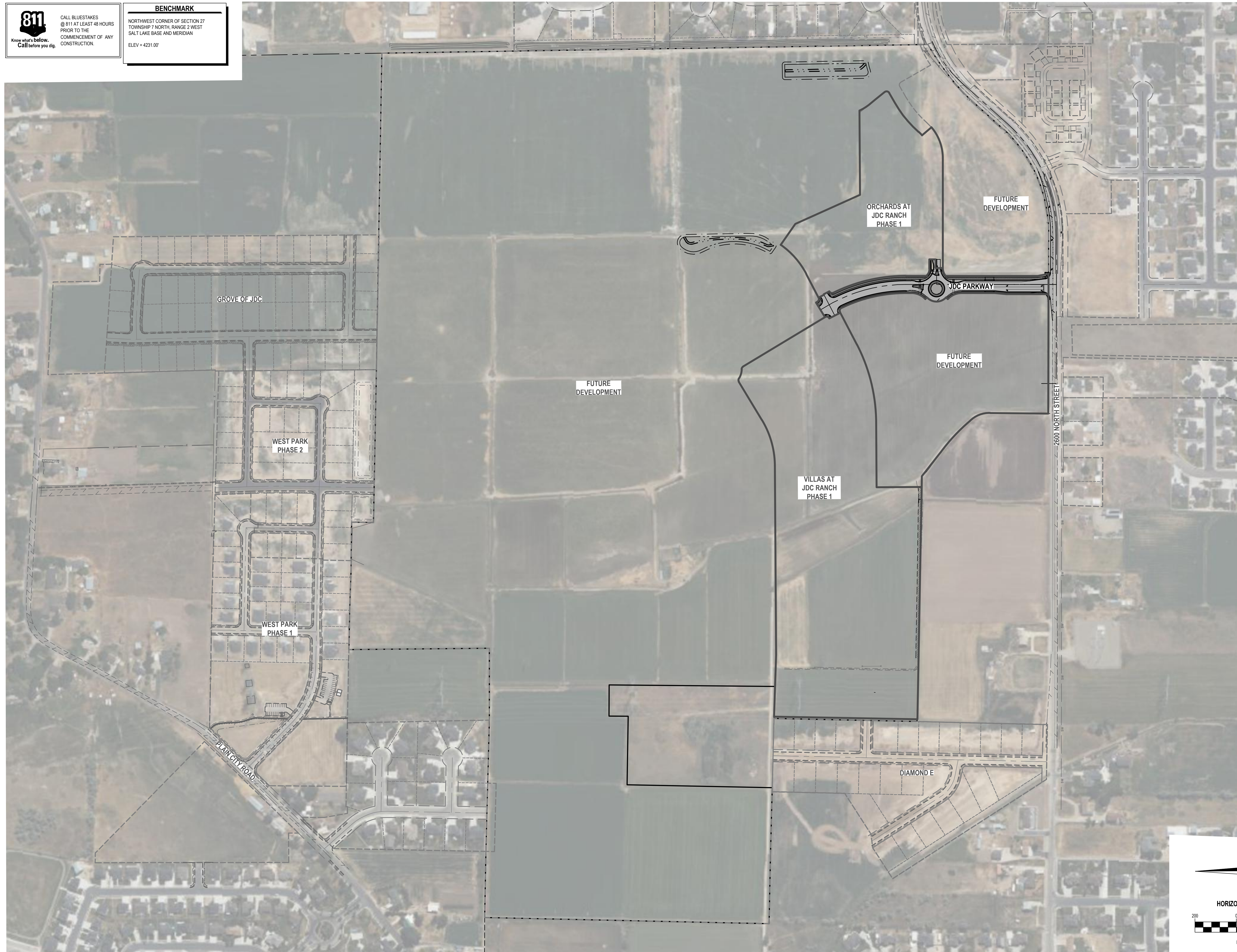

ENSIGN
 THE STANDARD IN ENGINEERING

LAYTON
 919 North 400 West
 Layton, UT 84041
 Phone: 801.547.1100

SANDY
 Phone: 801.255.0529

TOOELE
 Phone: 435.843.3590

CEDAR CITY
 Phone: 435.865.1453

RICHFIELD
 Phone: 435.896.2983

WWW.ENSIGNENG.COM

FOR:
 NILSON HOMES
 1740 COMBE RD, SUITE 2
 SOUTH OGDEN, UT 84403

CONTACT:
 STEVE ANDERSON
 PHONE: 801.392.8100

JDC PARKWAY
2800 WEST 2600 NORTH STREET
WEBER COUNTY, UTAH



NO.	DATE	REVISION
		FOR REVIEW

**OVERALL DEVELOPMENT
 SITE PLAN**

PROJECT NUMBER: 9872
 PRINT DATE: 2023-11-13
 PROJECT MANAGER: CP
 DESIGNED BY: TS

C-002

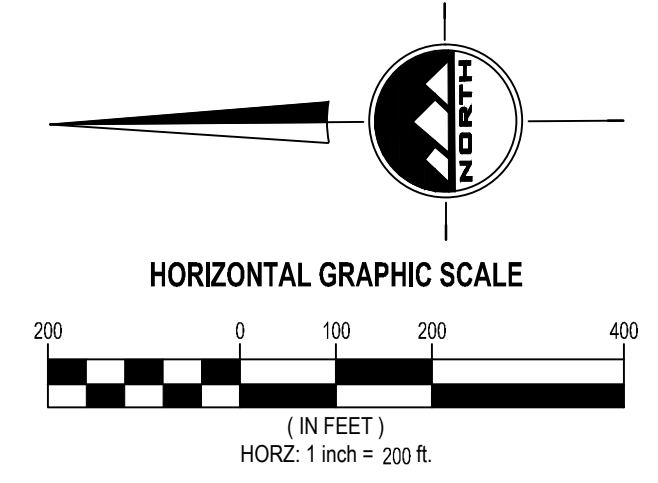



BENCHMARK	
NORTHWEST CORNER OF SECTION 27 TOWNSHIP 7 NORTH, RANGE 2 WEST SALT LAKE BASE AND MERIDIAN	ELEV = 4231.00'

- GENERAL NOTES**
1. ALL WORK TO COMPLY WITH THE GOVERNING AGENCY'S STANDARDS AND SPECIFICATIONS.
 2. ALL IMPROVEMENTS MUST COMPLY WITH ADA STANDARDS AND RECOMMENDATIONS.
 3. SEE LANDSCAPE/ARCHITECTURAL PLANS FOR CONCRETE MATERIAL, COLOR, FINISH, AND SCORE PATTERNS THROUGHOUT SITE.
 4. ALL PAVEMENT MARKINGS SHALL CONFORM TO THE LATEST EDITION OF THE M.U.T.C.D. (MANUAL ON UNIFORM TRAFFIC CONTROL DEVICES).
 5. ALL SURFACE IMPROVEMENTS DISTURBED BY CONSTRUCTION SHALL BE RESTORED OR REPLACED, INCLUDING TREES AND DECORATIVE SHRUBS, SOO, FENCES, WALLS AND STRUCTURES, WHETHER OR NOT THEY ARE SPECIFICALLY SHOWN ON THE CONTRACT DOCUMENTS.
 6. NOTIFY ENGINEER OF ANY DISCREPANCIES IN DESIGN OR STAKING BEFORE PLACING CONCRETE OR ASPHALT.
 7. THE CONTRACTOR IS TO PROTECT AND PRESERVE ALL EXISTING IMPROVEMENTS, UTILITIES, AND SIGNS, ETC. UNLESS OTHERWISE NOTED ON THESE PLANS.

- SCOPE OF WORK:**
PROVIDE, INSTALL AND/OR CONSTRUCT THE FOLLOWING PER THE SPECIFICATIONS GIVEN OR REFERENCED, THE DETAILS NOTED, AND/OR AS SHOWN ON THE CONSTRUCTION DRAWINGS:
1. INSTALL HANDICAP ACCESSIBLE RAMP
 2. INSTALL 30" TYPE A CURB AND GUTTER PER APWA STANDARDS AND SPECIFICATIONS
 3. INSTALL CONCRETE SIDEWALK, WIDTH PER PLAN
 4. MATCH EXISTING IMPROVEMENTS
 5. EXIST UTILITY POLE TO REMAIN
 6. INSTALL STREET LIGHT
 7. INSTALL DUAL PARALLEL RAMP PER UDOT STANDARDS DRAWING PA 5
 8. "STOP" SIGN R1-1 PER M.U.T.C.D. STANDARD PLANS
 9. "YIELD" SIGN R1-2 PER M.U.T.C.D. STANDARD PLANS
 10. "ONE-WAY" SIGN R1-6 PER M.U.T.C.D. STANDARD PLANS
 11. "KEEP RIGHT" SIGN R4-7 PER M.U.T.C.D. STANDARD PLANS
 12. STREET SIGN PER WEBER COUNTY STANDARDS AND SPECIFICATIONS
 13. MODIFIED 30" REVERSE PAN TYPE 'F' CURB AND GUTTER PER DETAIL 12/C-500
 14. TYPE "P" CURB AND GUTTER PER APWA STANDARDS AND SPECIFICATIONS
 15. TYPE "Q" CURB AND GUTTER PER APWA STANDARDS AND SPECIFICATIONS
 16. CONCRETE PAVEMENT SECTION PER DETAIL 11/C-500

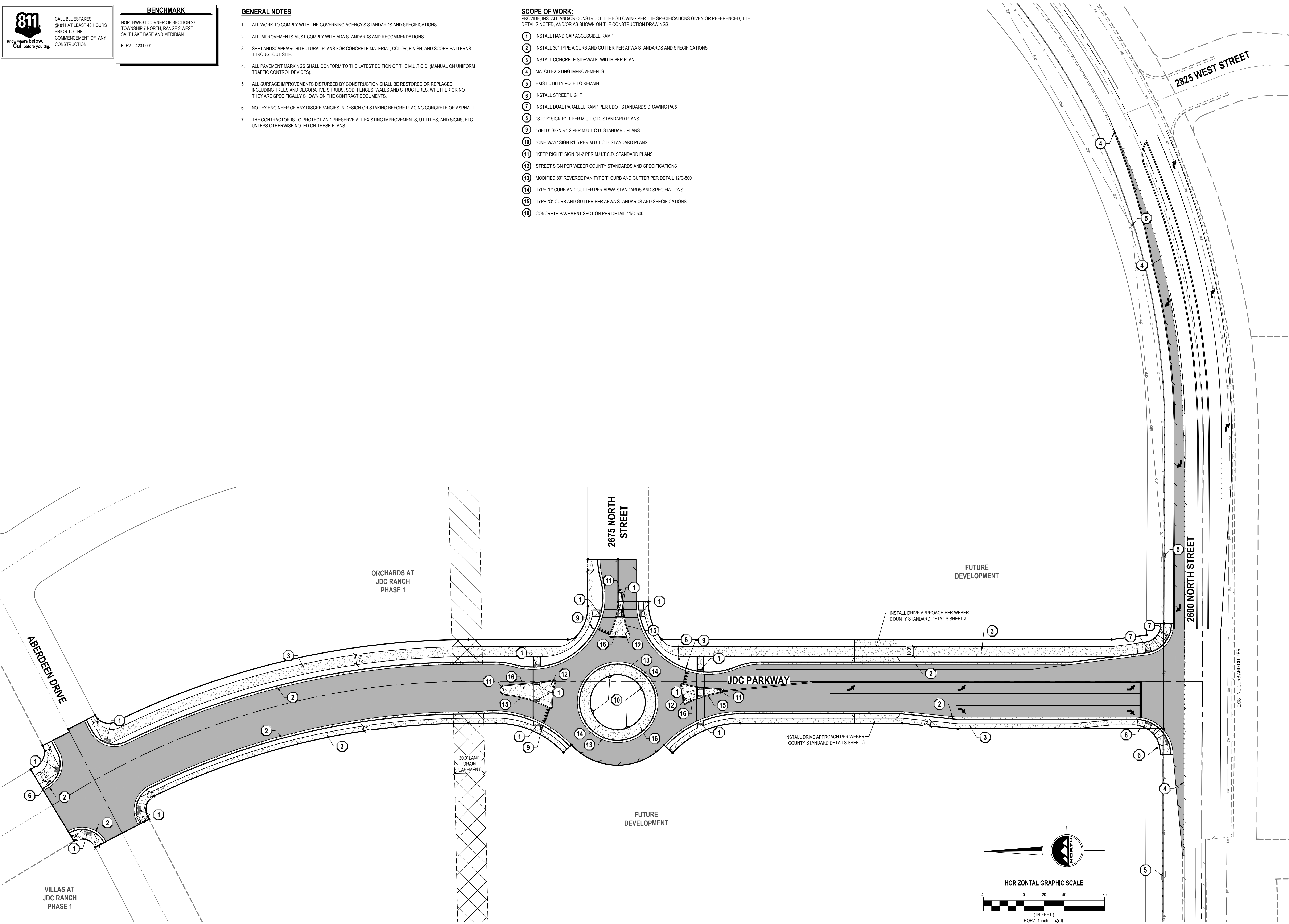

ENSIGN
THE STANDARD IN ENGINEERING

LAYTON
919 North 400 West
Layton, UT 84041
Phone: 801.547.1100

SANDY
Phone: 801.255.0529

TOOELE
Phone: 435.843.3590

CEDAR CITY
Phone: 435.865.1453

RICHFIELD
Phone: 435.896.2983

WWW.ENSIGNENG.COM

FOR:
NILSON HOVES
1740 COMBE RD, SUITE 2
SOUTH OGDEN, UT 84403

CONTACT:
STEVE ANDERSON
PHONE: 801.392.8100

JDC PARKWAY
2800 WEST 2600 NORTH STREET
WEBER COUNTY, UTAH

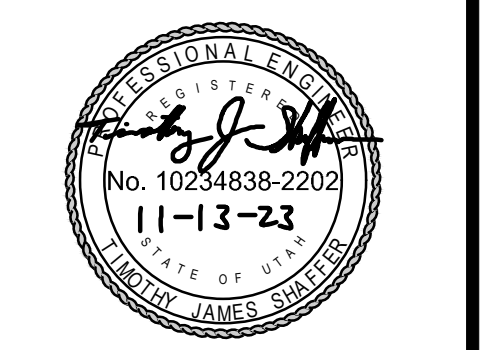

NO. DATE REVISION FOR REVIEW

SITE PLAN

PROJECT NUMBER 9872 PRINT DATE 2023-11-13
PROJECT MANAGER CP DESIGNED BY TS

C-100



BENCHMARK
 NORTHWEST CORNER OF SECTION 27
 TOWNSHIP 7 NORTH, RANGE 2 WEST
 SALT LAKE BASE AND MERIDIAN
 ELEV = 4231.00'

- GENERAL NOTES**
1. ALL WORK TO COMPLY WITH THE GOVERNING AGENCY'S STANDARDS AND SPECIFICATIONS.
 2. ALL IMPROVEMENTS MUST COMPLY WITH ADA STANDARDS AND RECOMMENDATIONS.
 3. SEE LANDSCAPE/ARCHITECTURAL PLANS FOR CONCRETE MATERIAL, COLOR, FINISH, AND SCORE PATTERNS THROUGHOUT SITE.
 4. ALL PAVEMENT MARKINGS SHALL CONFORM TO THE LATEST EDITION OF THE M.U.T.C.D. (MANUAL ON UNIFORM TRAFFIC CONTROL DEVICES).
 5. ALL SURFACE IMPROVEMENTS DISTURBED BY CONSTRUCTION SHALL BE RESTORED OR REPLACED, INCLUDING TREES AND DECORATIVE SHRUBS, SOD, FENCES, WALLS AND STRUCTURES, WHETHER OR NOT THEY ARE SPECIFICALLY SHOWN ON THE CONTRACT DOCUMENTS.
 6. NOTIFY ENGINEER OF ANY DISCREPANCIES IN DESIGN OR STAKING BEFORE PLACING CONCRETE OR ASPHALT.
 7. THE CONTRACTOR IS TO PROTECT AND PRESERVE ALL EXISTING IMPROVEMENTS, UTILITIES, AND SIGNS, ETC. UNLESS OTHERWISE NOTED ON THESE PLANS.

- SCOPE OF WORK:**
 PROVIDE, INSTALL AND/OR CONSTRUCT THE FOLLOWING PER THE SPECIFICATIONS GIVEN OR REFERENCED, THE DETAILS NOTED, AND/OR AS SHOWN ON THE CONSTRUCTION DRAWINGS:
- 1 4" SOLID WHITE LANE STRIPING PER UDOT STANDARDS
 - 2 12" SOLID WHITE STOP BAR PER MUTCD STANDARDS
 - 3 4" DOUBLE YELLOW SOLID LANE STRIPING PER UDOT STANDARDS
 - 4 REMOVE EXISTING STRIPING
 - 5 INSTALL PAVEMENT MARKER PER UDOT STANDARDS
 - 6 4" SOLID WHITE LANE STRIPING BY OTHERS
 - 7 PAVEMENT MARKER BY OTHERS
 - 8 4" SOLID WHITE LANE STRIPING
 - 9 4" DOUBLE YELLOW SOLID LANE STRIPING
 - 10 INSTALL PAVEMENT MARKER
 - 11 CROSSWALK STRIPING PER M.U.T.C.D. STANDARDS
 - 12 YIELD TRIANGLE STRIPING PER M.U.T.C.D. STANDARDS

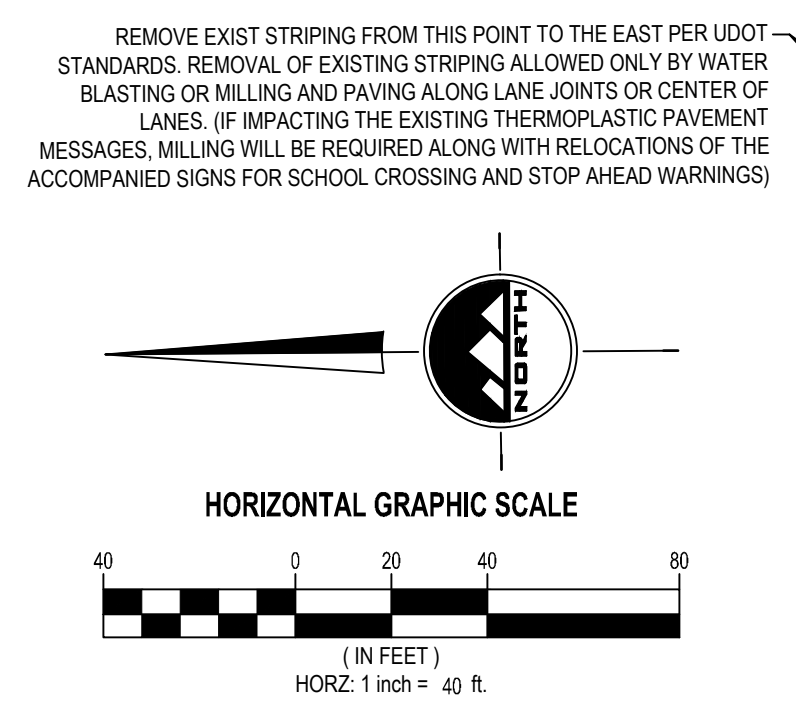
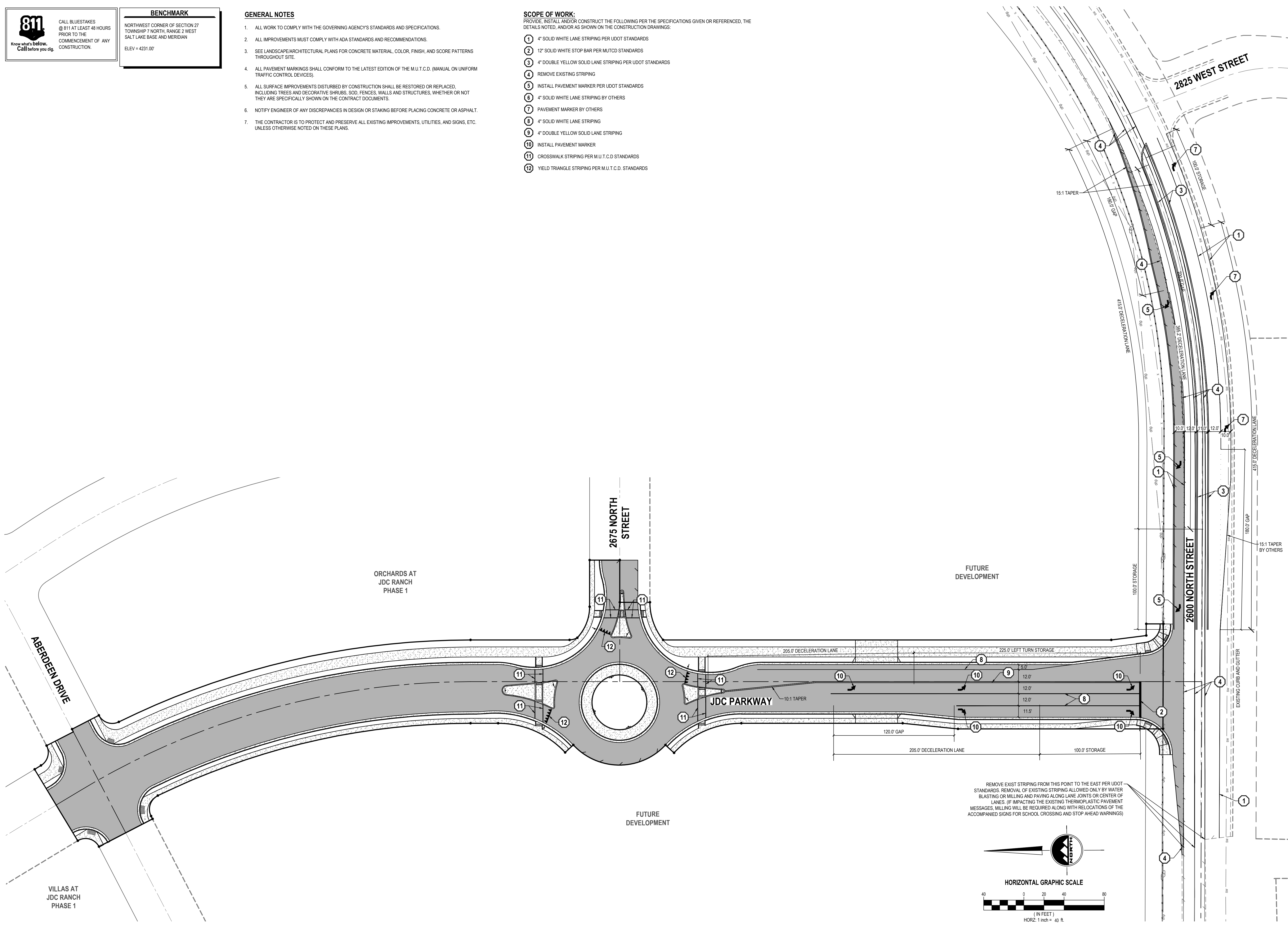

ENSIGN
 THE STANDARD IN ENGINEERING

LAYTON
 919 North 400 West
 Layton, UT 84041
 Phone: 801.547.1100

SANDY
 Phone: 801.255.0529

TOOELE
 Phone: 435.843.3590

CEDAR CITY
 Phone: 435.865.1453

RICHFIELD
 Phone: 435.896.2983

WWW.ENSIGNENG.COM

FOR:
 NILSON HOMES
 1740 COMBE RD. SUITE 2
 SOUTH OGDEN, UT 84403

CONTACT:
 STEVE ANDERSON
 PHONE: 801.392.8100

JDC PARKWAY
 2800 WEST 2600 NORTH STREET
 WEBER COUNTY, UTAH

NO. DATE REVISION FOR REVIEW

STRIPING PLAN

PROJECT NUMBER 9872 PRINT DATE 2023-11-13
 PROJECT MANAGER CP DESIGNED BY TS

C-101

811
Know what's below.
Call before you dig.

CALL BLUESTAKES
@ 811 AT LEAST 48 HOURS
PRIOR TO THE
COMMENCEMENT OF ANY
CONSTRUCTION.

BENCHMARK

NORTHWEST CORNER OF SECTION 27
TOWNSHIP 7 NORTH, RANGE 2 WEST
SALT LAKE BASE AND MERIDIAN
ELEV = 4231.00'

- GENERAL NOTES**
1. ALL WORK TO COMPLY WITH THE GOVERNING AGENCY'S STANDARDS AND SPECIFICATIONS.
 2. ALL IMPROVEMENTS MUST COMPLY WITH ADA STANDARDS AND RECOMMENDATIONS.
 3. ALL WORK SHALL COMPLY WITH THE RECOMMENDATIONS OF THE GEOTECHNICAL ENGINEER POSSIBLY INCLUDING, BUT NOT LIMITED TO, REMOVAL OF UNCONSOLIDATED FILL, ORGANICS, AND DEBRIS, PLACEMENT OF SUBSURFACE DRAIN LINES AND GEOTEXTILE, AND OVEREXCAVATION OF UNSUITABLE BEARING MATERIALS AND PLACEMENT OF ACCEPTABLE FILL MATERIAL.
 4. THE CONTRACTOR SHALL BECOME FAMILIAR WITH THE EXISTING SOIL CONDITIONS.
 5. ELEVATIONS HAVE BEEN TRUNCATED FOR CLARITY. XX.XX REPRESENTS AN ELEVATION OF 48XX.XX ON THESE PLANS.
 6. LANDSCAPED AREAS REQUIRE SUBGRADE TO BE MAINTAINED AT A SPECIFIC ELEVATION BELOW FINISHED GRADE AND REQUIRE SUBGRADE TO BE PROPERLY PREPARED AND SCARIFIED. SEE LANDSCAPE PLANS FOR ADDITIONAL INFORMATION.
 7. SLOPE ALL LANDSCAPED AREAS AWAY FROM BUILDING FOUNDATIONS TOWARD CURB AND GUTTER OR STORM DRAIN INLETS.
 8. EXISTING UNDERGROUND UTILITIES AND IMPROVEMENTS ARE SHOWN IN THEIR APPROXIMATE LOCATIONS BASED UPON RECORD INFORMATION AVAILABLE AT THE TIME OF PREPARATION OF THESE PLANS. LOCATIONS MAY NOT HAVE BEEN VERIFIED IN THE FIELD AND NO GUARANTEE IS MADE AS TO THE ACCURACY OR COMPLETENESS OF THE INFORMATION SHOWN. IT SHALL BE THE RESPONSIBILITY OF THE CONTRACTOR TO DETERMINE THE EXISTENCE AND LOCATION OF THE UTILITIES SHOWN ON THESE PLANS OR INDICATED IN THE FIELD BY LOCATING SERVICES. ANY ADDITIONAL COSTS INCURRED AS A RESULT OF THE CONTRACTOR'S FAILURE TO VERIFY THE LOCATIONS OF EXISTING UTILITIES PRIOR TO THE BEGINNING OF CONSTRUCTION IN THEIR VICINITY SHALL BE BORNE BY THE CONTRACTOR AND ASSUMED INCLUDED IN THE CONTRACT. THE CONTRACTOR IS TO VERIFY ALL CONNECTION POINTS WITH THE EXISTING UTILITIES. THE CONTRACTOR IS RESPONSIBLE FOR ANY DAMAGE CAUSED TO THE EXISTING UTILITIES AND UTILITY STRUCTURES THAT ARE TO REMAIN. IF CONFLICTS WITH EXISTING UTILITIES OCCUR, THE CONTRACTOR SHALL NOTIFY THE ENGINEER PRIOR TO CONSTRUCTION TO DETERMINE IF ANY FIELD ADJUSTMENTS SHOULD BE MADE.
 9. ALL STORM DRAIN INFRASTRUCTURE TO BE INSTALLED PER GOVERNING AGENCY OR APWA STANDARD PLANS AND SPECIFICATIONS.
 10. ENSURE MINIMUM COVER OVER ALL STORM DRAIN PIPES PER MANUFACTURER'S RECOMMENDATIONS. NOTIFY ENGINEER IF MINIMUM COVER CANNOT BE ATTAINED.
 11. ALL FACILITIES WITH DOWNSPOUTS/ROOF DRAINS SHALL BE CONNECTED TO THE STORM DRAIN SYSTEM. SEE PLUMBING PLANS FOR DOWNSPOUT/ROOF DRAIN LOCATIONS AND SIZES. ALL ROOF DRAINS TO HAVE MINIMUM 1% SLOPE.
 12. THE CONTRACTOR SHALL ADJUST TO GRADE ALL EXISTING UTILITIES AS NEEDED PER LOCAL GOVERNING AGENCY'S STANDARDS AND SPECIFICATIONS.
 13. NOTIFY ENGINEER OF ANY DISCREPANCIES IN DESIGN OR STAKING BEFORE PLACING CONCRETE, ASPHALT, OR STORM DRAIN STRUCTURES OR PIPES.
 14. THE CONTRACTOR IS TO PROTECT AND PRESERVE ALL EXISTING IMPROVEMENTS, UTILITIES, AND SIGNS, ETC. UNLESS OTHERWISE NOTED ON THESE PLANS.

ENSIGN
THE STANDARD IN ENGINEERING

LAYTON
919 North 400 West
Layton, UT 84041
Phone: 801.547.1100

SANDY
Phone: 801.255.0529

TOOLEE
Phone: 435.843.3590

CEDAR CITY
Phone: 435.865.1453

RICHFIELD
Phone: 435.896.2983

WWW.ENSIGNENG.COM

FOR:
NILSON HOVES
1740 COMBE RD, SUITE 2
SOUTH OGDEN, UT 84403

CONTACT:
STEVE ANDERSON
PHONE: 801.392.8100

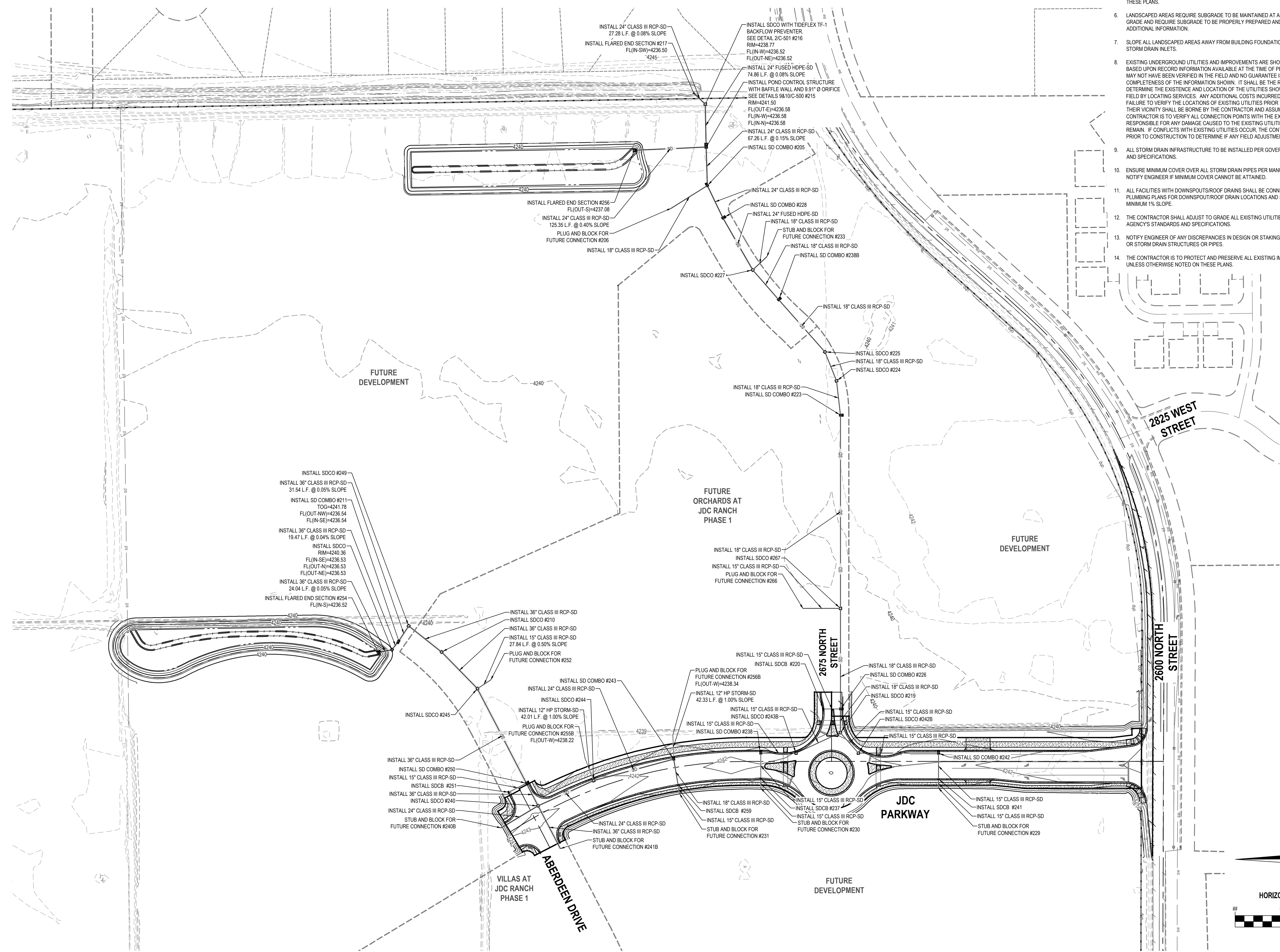

JDC PARKWAY

2800 WEST 2600 NORTH STREET

WEBER COUNTY, UTAH

PROFESSIONAL ENGINEER
No. 10234838-2202
11-13-23
STATE OF UTAH
JAMES B. JENSEN

NO.	DATE	REVISION FOR REVIEW

OVERALL GRADING AND DRAINAGE PLAN

PROJECT NUMBER 9872	PRINT DATE 2023-11-13
PROJECT MANAGER CP	DESIGNED BY TS

C-200

811
Know what's below.
Call before you dig.

BENCHMARK
NORTHWEST CORNER OF SECTION 27
TOWNSHIP 7 NORTH, RANGE 2 WEST
SALT LAKE BASE AND MERIDIAN
ELEV = 4231.00'

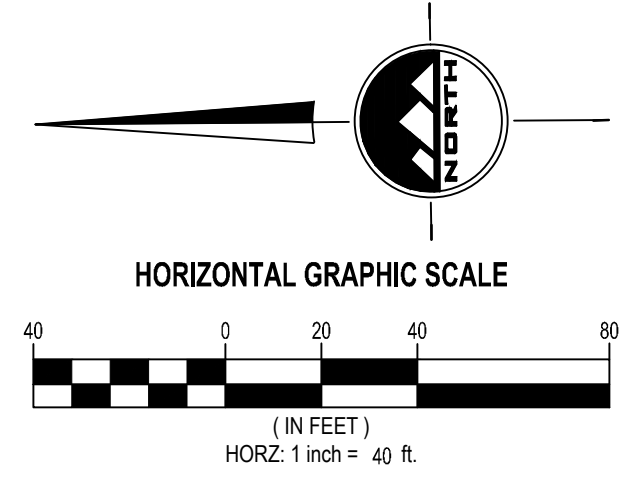
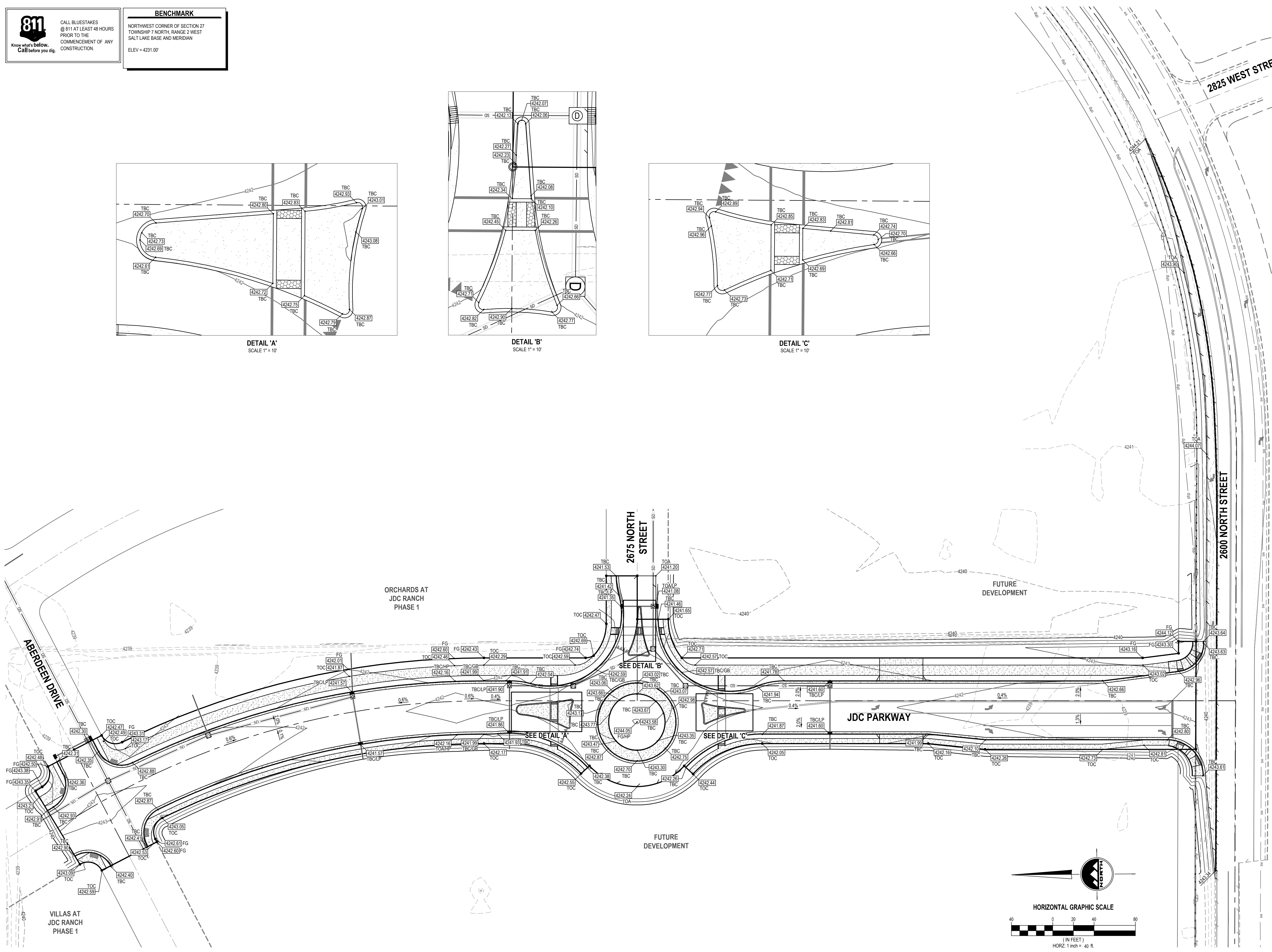
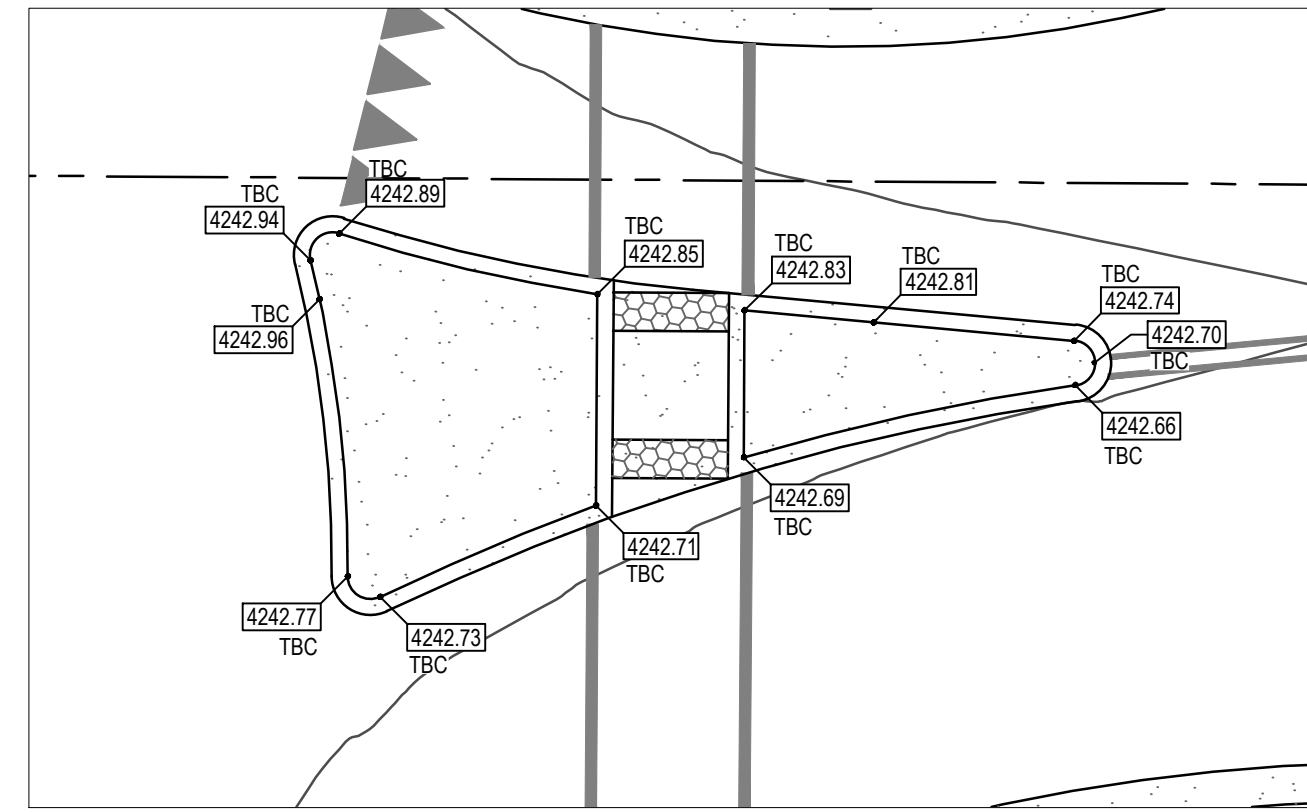
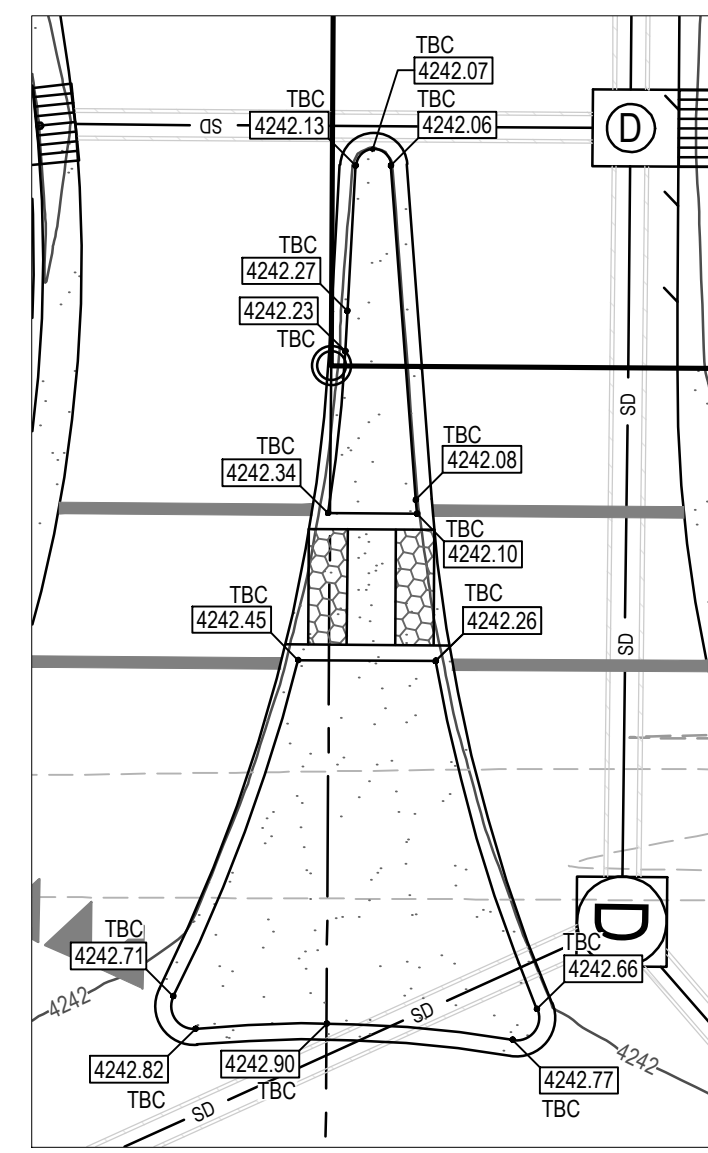
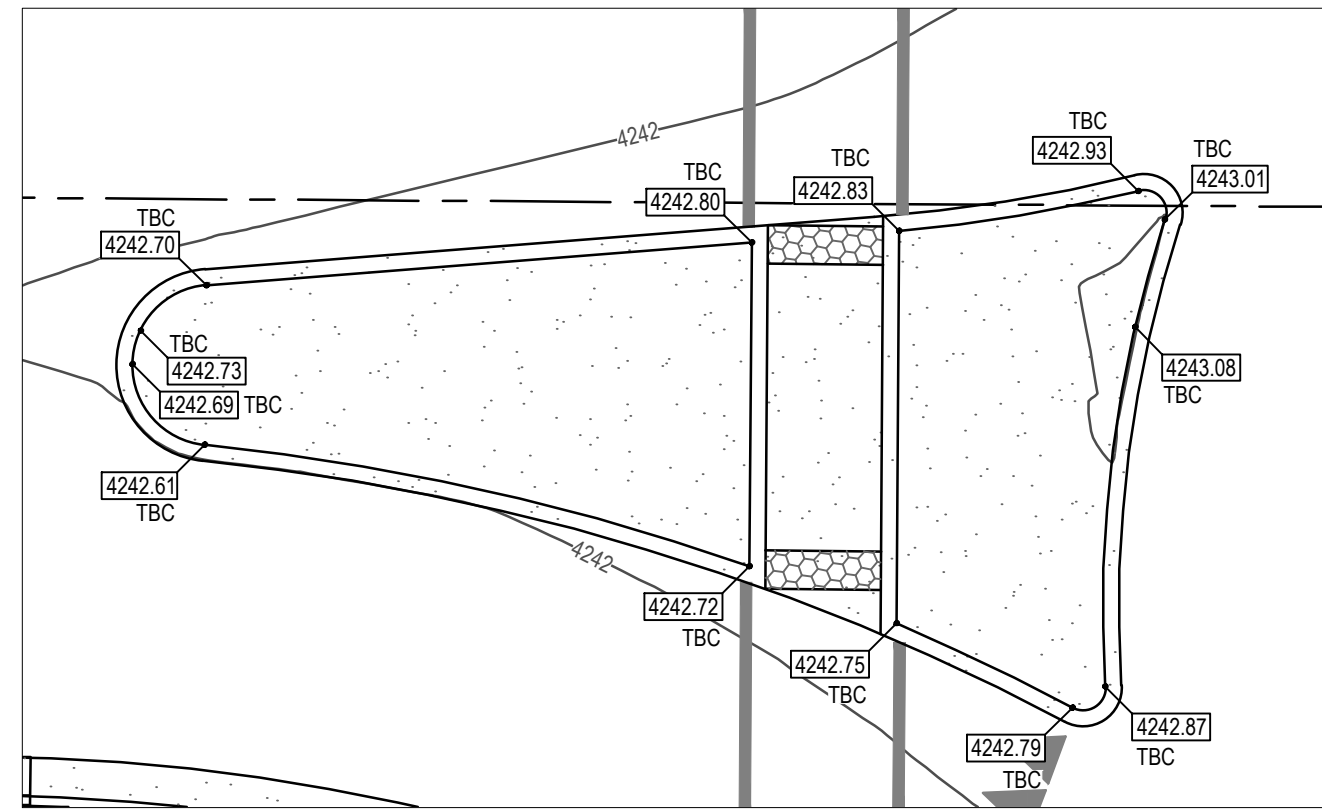

ENSIGN
THE STANDARD IN ENGINEERING

LAYTON
919 North 400 West
Layton, UT 84041
Phone: 801.547.1100

SANDY
Phone: 801.255.0529

TOOELE
Phone: 435.843.3590

CEDAR CITY
Phone: 435.865.1453

RICHFIELD
Phone: 435.896.2983

WWW.ENSIGNENG.COM

FOR:
NILSON HOMES
1740 COMBE RD. SUITE 2
SOUTH OGDEN UT 84403

CONTACT:
STEVE ANDERSON
PHONE: 801.392.8100

JDC PARKWAY
2800 WEST 2600 NORTH STREET
WEBER COUNTY, UTAH



NO. DATE REVISION FOR REVIEW

GRADING AND DRAINAGE PLAN

PROJECT NUMBER 9872
PROJECT MANAGER CP

PRINT DATE 2023-11-13
DESIGNED BY TS

C-201

811
Know what's below.
Call before you dig.

BENCHMARK
NORTHWEST CORNER OF SECTION 27
TOWNSHIP 7 NORTH, RANGE 2 WEST
SALT LAKE BASE AND MERIDIAN
ELEV = 4231.00'

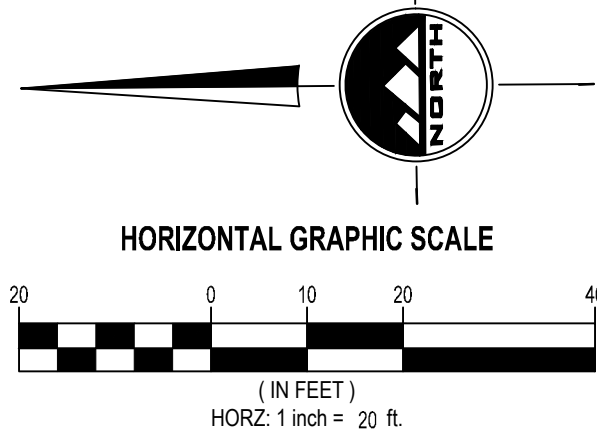
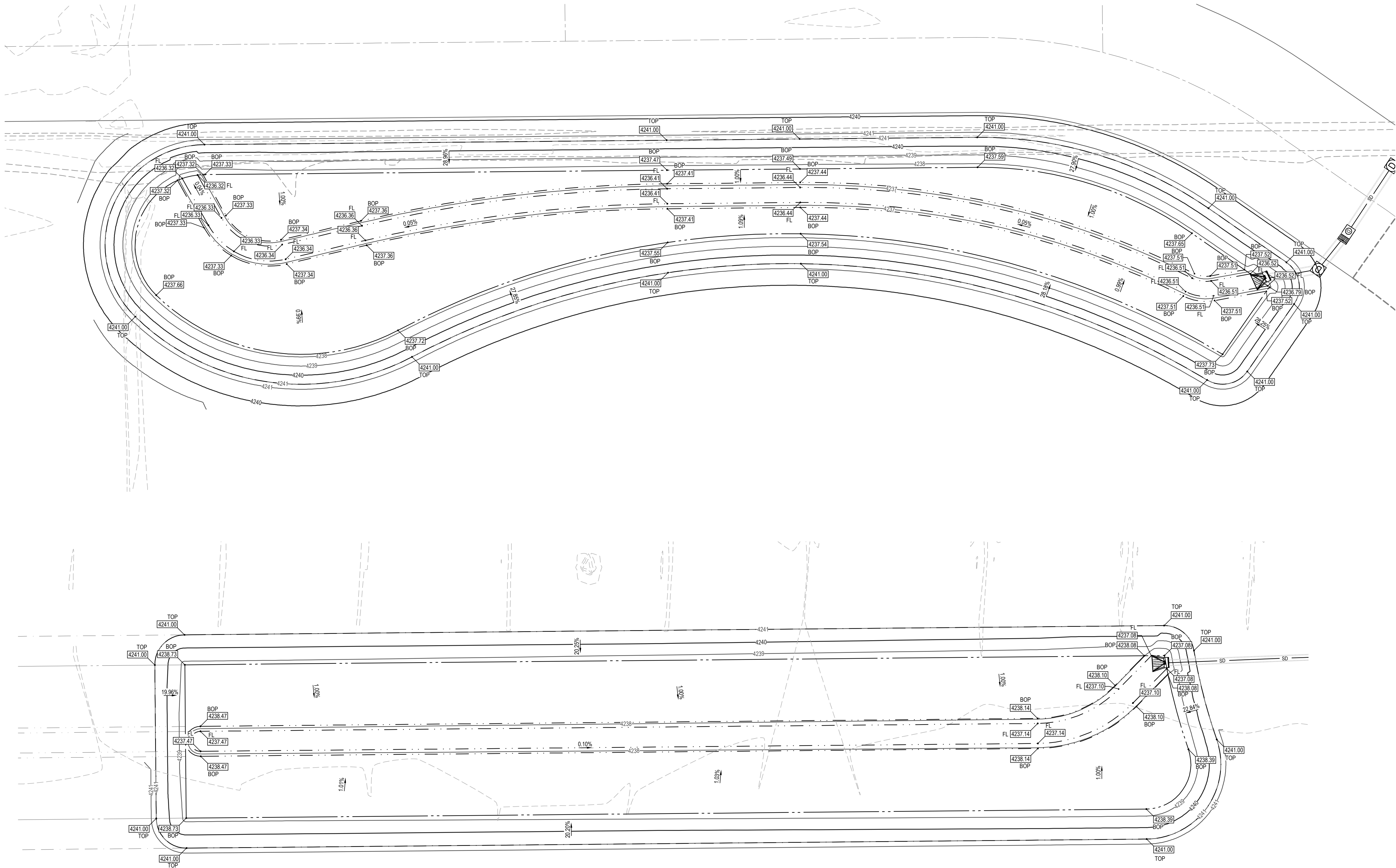

ENSIGN
THE STANDARD IN ENGINEERING

LAYTON
919 North 400 West
Layton, UT 84041
Phone: 801.547.1100

SANDY
Phone: 801.255.0529

TOOELE
Phone: 435.843.3590

CEDAR CITY
Phone: 435.865.1453

RICHFIELD
Phone: 435.896.2983

WWW.ENSIGNENG.COM

FOR:
NILSON HOVES
1740 COMBE RD, SUITE 2
SOUTH OGDEN, UT 84403

CONTACT:
STEVE ANDERSON
PHONE: 801.392.8100

JDC PARKWAY
2800 WEST 2600 NORTH STREET
WEBER COUNTY, UTAH

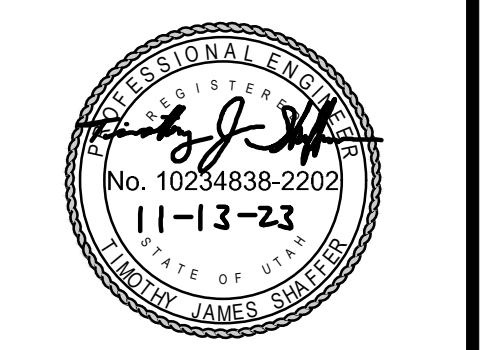

NO. DATE REVISION FOR REVIEW

GRADING AND DRAINAGE PLAN

PROJECT NUMBER 9872 PRINT DATE 2023-11-13
PROJECT MANAGER CP DESIGNED BY TS

C-202

811
Know what's below.
Call before you dig.

CALL BLUESTAKES
@ 811 AT LEAST 48 HOURS
PRIOR TO THE
COMMENCEMENT OF ANY
CONSTRUCTION.

BENCHMARK

NORTHWEST CORNER OF SECTION 27
TOWNSHIP 7 NORTH, RANGE 2 WEST
SALT LAKE BASE AND MERIDIAN
ELEV = 4231.00'

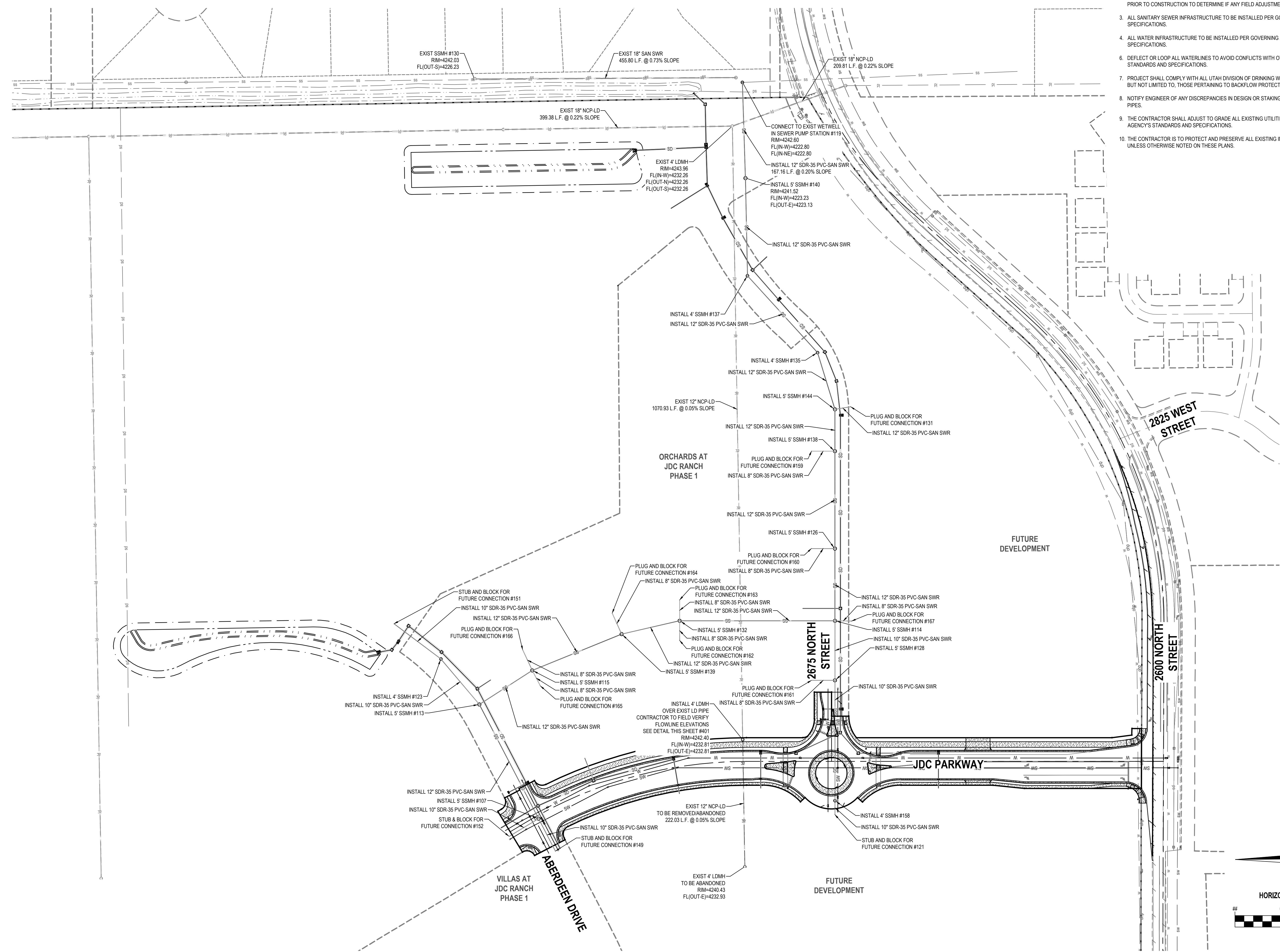

- GENERAL NOTES**
1. ALL WORK TO COMPLY WITH THE GOVERNING AGENCY'S STANDARDS AND SPECIFICATIONS.
 2. EXISTING UNDERGROUND UTILITIES AND IMPROVEMENTS ARE SHOWN IN THEIR APPROXIMATE LOCATIONS BASED UPON RECORD INFORMATION AVAILABLE AT THE TIME OF PREPARATION OF THESE PLANS. LOCATIONS MAY NOT HAVE BEEN VERIFIED IN THE FIELD AND NO GUARANTEE IS MADE AS TO THE ACCURACY OR COMPLETENESS OF THE INFORMATION SHOWN. IT SHALL BE THE RESPONSIBILITY OF THE CONTRACTOR TO DETERMINE THE EXISTENCE AND LOCATION OF THE UTILITIES SHOWN ON THESE PLANS OR INDICATED IN THE FIELD BY LOCATING SERVICES. ANY ADDITIONAL COSTS INCURRED AS A RESULT OF THE CONTRACTOR'S FAILURE TO VERIFY THE LOCATIONS OF EXISTING UTILITIES PRIOR TO THE BEGINNING OF CONSTRUCTION IN THEIR VICINITY SHALL BE BORNE BY THE CONTRACTOR AND ASSUMED INCLUDED IN THE CONTRACT. THE CONTRACTOR IS TO VERIFY ALL CONNECTION POINTS WITH THE EXISTING UTILITIES. THE CONTRACTOR IS RESPONSIBLE FOR ANY DAMAGE CAUSED TO THE EXISTING UTILITIES AND UTILITY STRUCTURES THAT ARE TO REMAIN. IF CONFLICTS WITH EXISTING UTILITIES OCCUR, THE CONTRACTOR SHALL NOTIFY THE ENGINEER PRIOR TO CONSTRUCTION TO DETERMINE IF ANY FIELD ADJUSTMENTS SHOULD BE MADE.
 3. ALL SANITARY SEWER INFRASTRUCTURE TO BE INSTALLED PER GOVERNING AGENCY STANDARD PLANS AND SPECIFICATIONS.
 4. ALL WATER INFRASTRUCTURE TO BE INSTALLED PER GOVERNING AGENCY OR APWA STANDARD PLANS AND SPECIFICATIONS.
 5. DEFLECT OR LOOP ALL WATERLINES TO AVOID CONFLICTS WITH OTHER UTILITIES PER GOVERNING AGENCY'S STANDARDS AND SPECIFICATIONS.
 6. PROJECT SHALL COMPLY WITH ALL UTAH DIVISION OF DRINKING WATER RULES AND REGULATIONS INCLUDING, BUT NOT LIMITED TO, THOSE PERTAINING TO BACKFLOW PROTECTION AND CROSS CONNECTION PREVENTION.
 7. NOTIFY ENGINEER OF ANY DISCREPANCIES IN DESIGN OR STAKING BEFORE PLACING UTILITY STRUCTURES OR PIPES.
 8. THE CONTRACTOR SHALL ADJUST TO GRADE ALL EXISTING UTILITIES AS NEEDED PER LOCAL GOVERNING AGENCY'S STANDARDS AND SPECIFICATIONS.
 9. THE CONTRACTOR IS TO PROTECT AND PRESERVE ALL EXISTING IMPROVEMENTS, UTILITIES, AND SIGNS, ETC. UNLESS OTHERWISE NOTED ON THESE PLANS.

ENSIGN
THE STANDARD IN ENGINEERING

LAYTON
919 North 400 West
Layton, UT 84041
Phone: 801.547.1100

SANDY
Phone: 801.255.0529

TOOELE
Phone: 435.843.3590

CEDAR CITY
Phone: 435.865.1453

RICHFIELD
Phone: 435.896.2983

WWW.ENSIGNENG.COM

FOR:
NILSON HOMES
1740 COMBE RD. SUITE 2
SOUTH OGDEN, UT 84403

CONTACT:
STEVE ANDERSON
PHONE: 801.392.8100

JDC PARKWAY

2800 WEST 2600 NORTH STREET

WEBER COUNTY, UTAH



NO.	DATE	REVISION
		FOR REVIEW

OVERALL UTILITY PLAN

PROJECT NUMBER 9872	PRINT DATE 2023-11-13
PROJECT MANAGER CP	DESIGNED BY TS

C-300

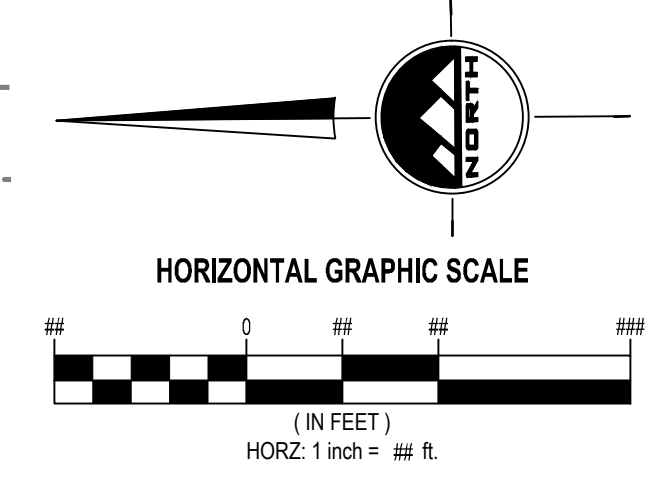



BENCHMARK

NORTHWEST CORNER OF SECTION 27
TOWNSHIP 7 NORTH, RANGE 2 WEST
SALT LAKE BASE AND MERIDIAN
ELEV = 4231.00'

SCOPE OF WORK:

- PROVIDE, INSTALL AND/OR CONSTRUCT THE FOLLOWING PER THE SPECIFICATIONS GIVEN OR REFERENCED, THE DETAILS NOTED, AND/OR AS SHOWN ON THE CONSTRUCTION DRAWINGS:
- 1 INSTALL 8" C900 DR18 PVC CULINARY WATERLINE PER BONA VISTA WATER IMPROVEMENT DISTRICT STANDARDS AND SPECIFICATIONS
- 2 INSTALL 8" C900 DR18 PVC "PURPLE" SECONDARY WATERLINE PER PINEVIEW WATER SYSTEMS STANDARDS AND SPECIFICATIONS
- 3 FIELD LOCATE AND HOT TAP TO EXISTING CULINARY WATERLINE PER BONA VISTA WATER IMPROVEMENT DISTRICT STANDARDS AND SPECIFICATIONS
- 4 NOT USED
- 5 INSTALL STREET LIGHT PER WEBER COUNTY STANDARDS AND SPECIFICATIONS. COORDINATE ALL PROPOSED STREET LIGHT LOCATIONS WITH WEBER COUNTY AND THE STREET LIGHT INSTALLATION WITH ROCKY MOUNTAIN POWER.
- 6 PLUG AND BLOCK FOR FUTURE CONNECTION
- 7 EXISTING POWER POLE
- 8 INSTALL FIRE HYDRANT AND VALVE PER BONA VISTA WATER IMPROVEMENT DISTRICT STANDARDS AND SPECIFICATIONS.
- 9 INSTALL 10" MJ CAP PER PINEVIEW WATER SYSTEMS STANDARDS AND SPECIFICATIONS
- 10 INSTALL 8" MJ CAP PER PINEVIEW WATER SYSTEMS STANDARDS AND SPECIFICATIONS
- 11 INSTALL 10" C900 DR18 PVC "PURPLE" SECONDARY WATERLINE PER PINEVIEW WATER SYSTEMS STANDARDS AND SPECIFICATIONS
- 12 INSTALL 22.5" MJ BEND PER PINEVIEW WATER SYSTEMS STANDARDS AND SPECIFICATIONS
- 13 INSTALL 6" MJ CAP PER PINEVIEW WATER SYSTEMS STANDARDS AND SPECIFICATIONS
- 14 INSTALL 6" MJ GATE VALVE PER PINEVIEW WATER SYSTEMS STANDARDS AND SPECIFICATIONS
- 15 INSTALL 10"x6" MJ CROSS PER PINEVIEW WATER SYSTEMS STANDARDS AND SPECIFICATIONS
- 16 INSTALL 6" C900 CR18 PVC "PURPLE" SECONDARY WATERLINE PER PINEVIEW WATER SYSTEMS STANDARDS AND SPECIFICATIONS
- 17 INSTALL 2" DRAIN VALVE (TYPE B) PER PINEVIEW WATER SYSTEMS STANDARDS AND SPECIFICATIONS
- 18 INSTALL 10" FLG X MJ GATE VALVE PER PINEVIEW WATER SYSTEMS STANDARDS AND SPECIFICATIONS
- 19 INSTALL 16" MACRO SLEEVE PER PINEVIEW WATER SYSTEMS STANDARDS AND SPECIFICATIONS
- 20 INSTALL 16" MJ X 10" FLG TEE PER PINEVIEW WATER SYSTEMS STANDARDS AND SPECIFICATIONS
- 21 INSTALL 8" FLG X MJ GATE VALVE PER PINEVIEW WATER SYSTEMS STANDARDS AND SPECIFICATIONS
- 22 INSTALL 10" MJ X 8" FLG CROSS PER PINEVIEW SYSTEMS STANDARDS AND SPECIFICATIONS

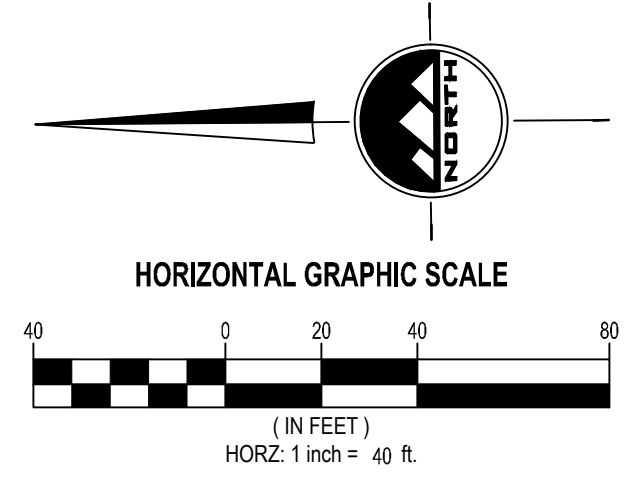
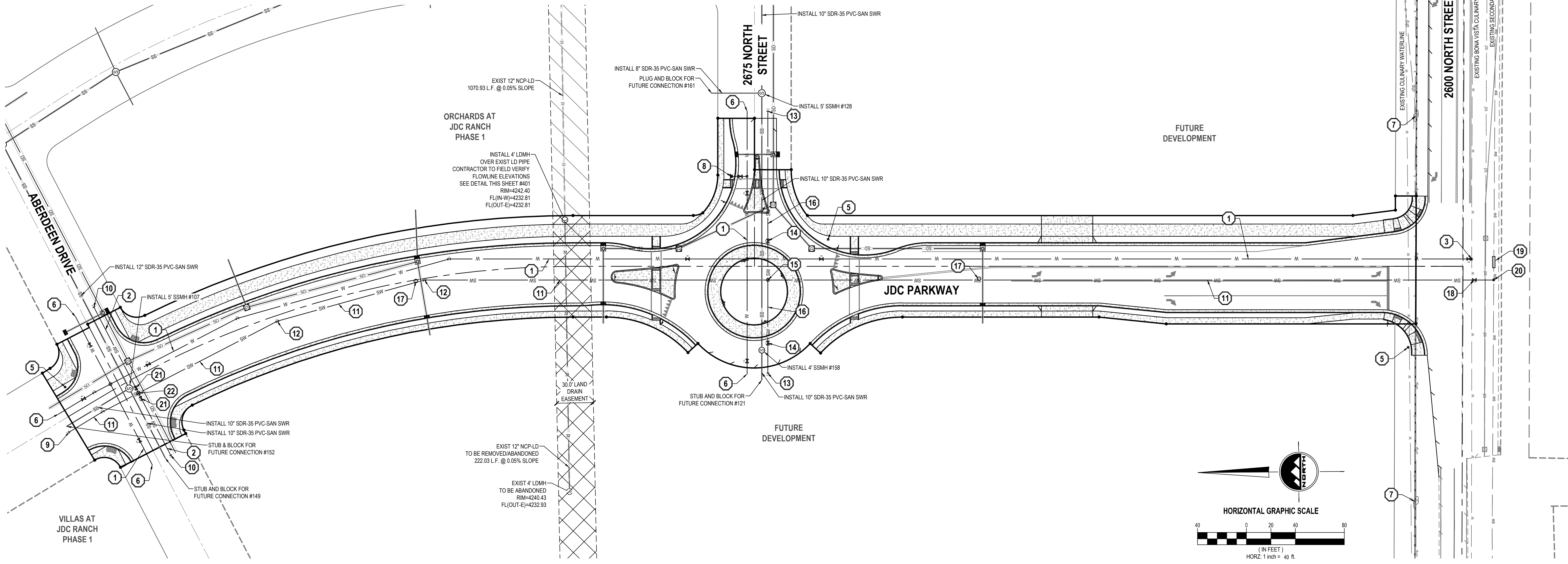

LAYTON
919 North 400 West
Layton, UT 84041
Phone: 801.547.1100

SANDY
Phone: 801.255.0529

TOOELE
Phone: 435.843.3590

CEDAR CITY
Phone: 435.865.1453

RICHFIELD
Phone: 435.896.2983

WWW.ENSIGNENG.COM

FOR:
NILSON HOVES
1740 COMBE RD, SUITE 2
SOUTH OGDEN, UT 84403

CONTACT:
STEVE ANDERSON
PHONE: 801.392.8100

JDC PARKWAY
2800 WEST 2600 NORTH STREET
WEBER COUNTY, UTAH

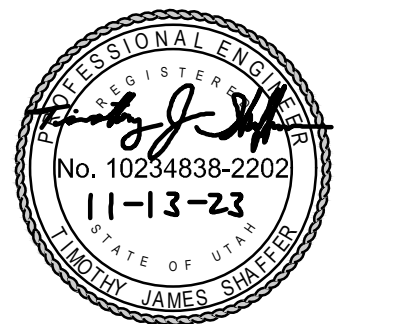

NO. DATE REVISION FOR REVIEW

UTILITY PLAN

PROJECT NUMBER 9872
PROJECT MANAGER CP
PRINT DATE 2023-11-13
DESIGNED BY TS

C-301

811
Know what's below.
Call before you dig.

CALL BLUESTAKES
@ 811 AT LEAST 48 HOURS
PRIOR TO THE
COMMENCEMENT OF ANY
CONSTRUCTION.

BENCHMARK
NORTHWEST CORNER OF SECTION 27
TOWNSHIP 7 NORTH, RANGE 2 WEST
SALT LAKE BASE AND MERIDIAN
ELEV = 4231.00'

- SCOPE OF WORK:**
PROVIDE, INSTALL AND/OR CONSTRUCT THE FOLLOWING PER THE SPECIFICATIONS GIVEN OR REFERENCED, THE DETAILS NOTED, AND/OR AS SHOWN ON THE CONSTRUCTION DRAWINGS:
- 1 INLET PROTECTION PER DETAIL 1/C-500.
 - 2 VEHICLE WASHDOWN AND STABILIZED CONSTRUCTION ENTRANCE PER DETAIL 2/C-500.
 - 3 SUGGESTED TEMPORARY CONSTRUCTION SITE PARKING, STAGING, DUMPSTER, AND MATERIAL STORAGE AREA.
 - 4 CONCRETE CLEANOUT LINED BASIN OR DUMPSTER
 - 5 LIMITS OF DISTURBANCE
 - 6 INSTALL TEMPORARY SILT FENCE PER DETAIL 5/C-500
 - 7 INSTALL OUTLET PROTECTION PER DETAIL 6/C-500

- GENERAL NOTES**
1. THIS PLAN IS DESIGNED AS A FIRST APPRAISAL OF NECESSARY MEANS TO PROTECT THE WATERS OF THE STATE FROM POTENTIAL POLLUTION. IT IS THE RESPONSIBILITY OF THE OWNER/OPERATOR TO ADD WARRANTED BEST MANAGEMENT PRACTICES (BMP'S) AS NECESSARY, MODIFY THOSE SHOWN AS APPROPRIATE, AND DELETE FROM THE PROJECT THOSE FOUND TO BE UNNECESSARY. FEDERAL AND STATE LAW ALLOWS THESE UPDATES TO BE MADE BY THE OWNER/OPERATOR ONSITE AND RECORDED BY THE OWNER/OPERATOR ON THE COPY OF THE SWPPP KEPT ONSITE.
 2. DISTURBED LAND SHALL BE KEPT TO A MINIMUM. STABILIZATION MEASURES SHALL BE INITIATED AS SOON AS PRACTICABLE IN PORTIONS OF THE SITE WHERE CONSTRUCTION ACTIVITIES HAVE TEMPORARILY OR PERMANENTLY CEASED, BUT IN NO CASE MORE THAN 14 DAYS AFTER THE CONSTRUCTION ACTIVITY IN THAT PORTION OF THE SITE HAS TEMPORARILY OR PERMANENTLY CEASED. HOWEVER, WHERE CONSTRUCTION ACTIVITY ON A PORTION OF THE SITE IS TEMPORARILY CEASED, AND EARTH DISTURBING ACTIVITIES WILL BE RESUMED WITHIN 21 DAYS, TEMPORARY STABILIZATION MEASURES DO NOT HAVE TO BE INITIATED ON THAT PORTION OF THE SITE.
 3. RESEED DISTURBED LAND WITH NATIVE GRASS MIXTURE WITHIN 14 CALENDAR DAYS OF ACHIEVEMENT OF FINISH GRADE TO STABILIZE SOILS IF LAND IS NOT TO BE RE-WORKED WITHIN 14 CALENDAR DAYS OF THE CESSATION OF CONSTRUCTION ACTIVITIES AT THAT LOCATION.
 4. DETAILS SHOWN ARE TO BE EMPLOYED TO PROTECT RUNOFF AS APPROPRIATE DURING CONSTRUCTION. NOT ALL DETAILS ARE NECESSARY AT ALL PHASES OF THE PROJECT. IT SHALL BE THE RESPONSIBILITY OF THE OWNER/OPERATOR TO USE APPROPRIATE BEST MANAGEMENT PRACTICES AT THE APPROPRIATE PHASE OF CONSTRUCTION. SEE SWPPP FOR BMP IMPLEMENTATION SCHEDULE.
 5. VARIOUS BEST MANAGEMENT PRACTICES HAVE BEEN SHOWN ON THE PLANS AT SUGGESTED LOCATIONS. THE CONTRACTOR MAY MOVE AND RECONFIGURE THESE BMP'S TO OTHER LOCATIONS IF PREFERRED, PROVIDED THE INTENT OF THE DESIGN IS PRESERVED.
 6. NOT ALL POSSIBLE BMP'S HAVE BEEN SHOWN. THE CONTRACTOR IS RESPONSIBLE TO APPLY CORRECT MEASURES TO PREVENT THE POLLUTION OF STORM WATER PER PROJECT SWPPP.
 7. A UPDES (UTAH POLLUTANT DISCHARGE ELIMINATION SYSTEM) PERMIT IS REQUIRED FOR ALL CONSTRUCTION ACTIVITIES 1 ACRE OR MORE.

REVISION SCHEDULE			
NUMBER	DATE	AUTHOR	COMPANY REPRESENTATIVE SIGNATURE
1			
2			
3			
4			
5			
6			
7			
8			
9			
10			
11			
12			

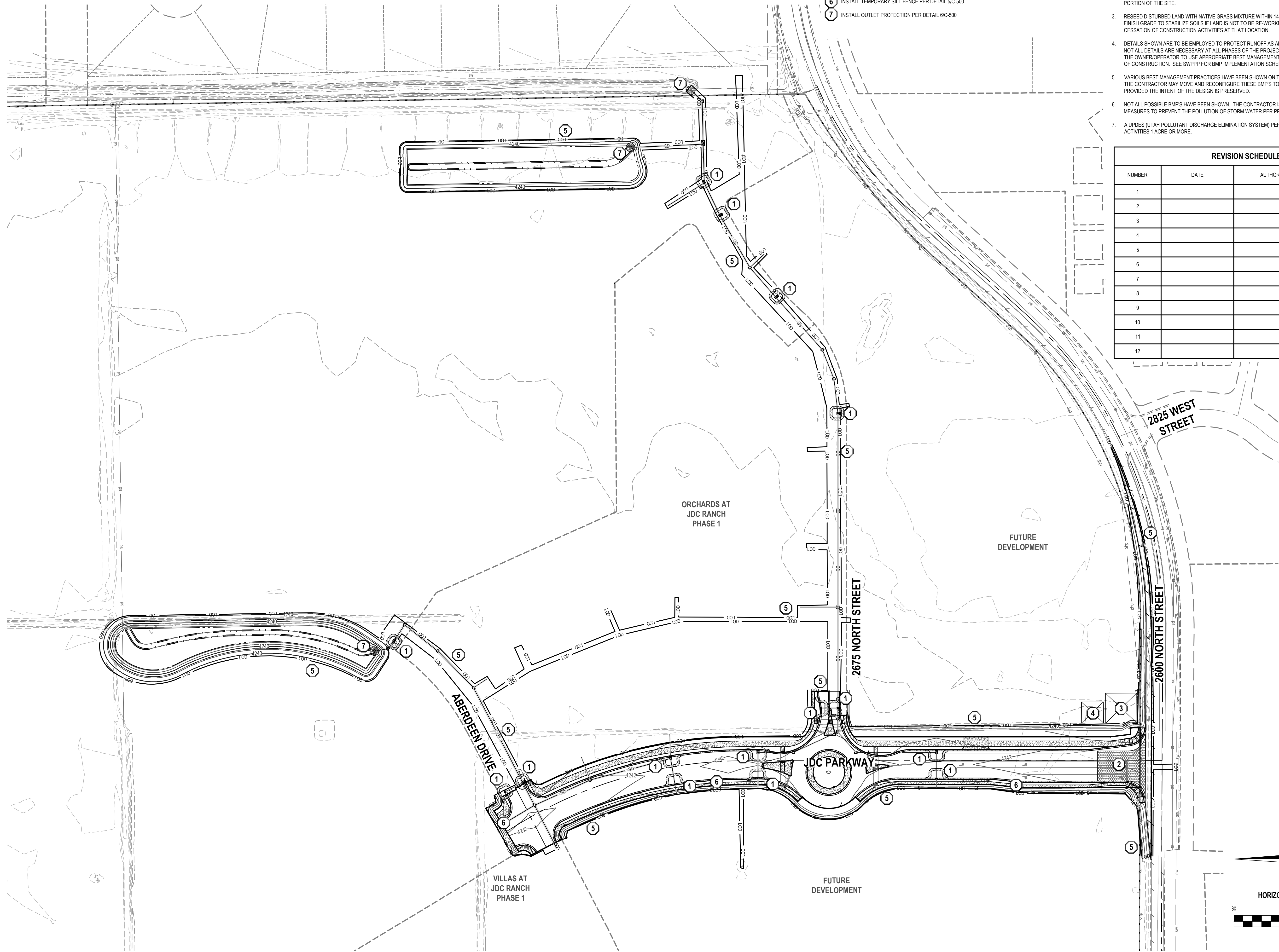

ENSIGN
THE STANDARD IN ENGINEERING

LAYTON
919 North 400 West
Layton, UT 84041
Phone: 801.547.1100

SANDY
Phone: 801.255.0529

TOOELE
Phone: 435.843.3590

CEDAR CITY
Phone: 435.865.1453

RICHFIELD
Phone: 435.896.2983

WWW.ENSIGNENG.COM

FOR:
NILSON HOVES
1740 COMBE RD, SUITE 2
SOUTH OGDEN, UT 84403

CONTACT:
STEVE ANDERSON
PHONE: 801.392.8100

JDC PARKWAY
2800 WEST 2600 NORTH STREET
WEBER COUNTY, UTAH



NO. DATE REVISION FOR REVIEW

EROSION CONTROL PLAN

PROJECT NUMBER 9872
PROJECT MANAGER CP

PRINT DATE 2023-11-13
DESIGNED BY TS

C-400

811
Know what's below.
Call before you dig.

BENCHMARK
NORTHWEST CORNER OF SECTION 27
TOWNSHIP 7 NORTH, RANGE 2 WEST
SALT LAKE BASE AND MERIDIAN
ELEV = 4231.00'

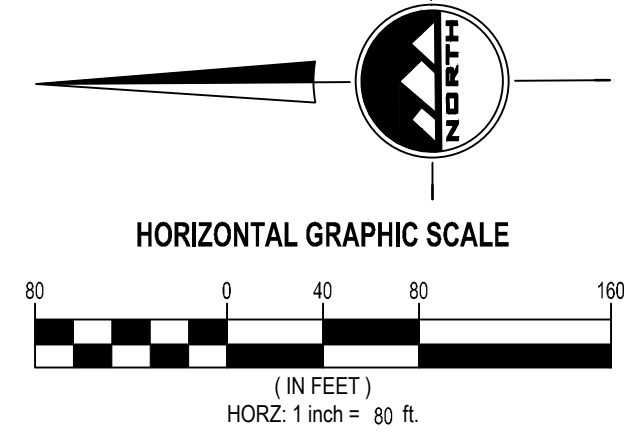
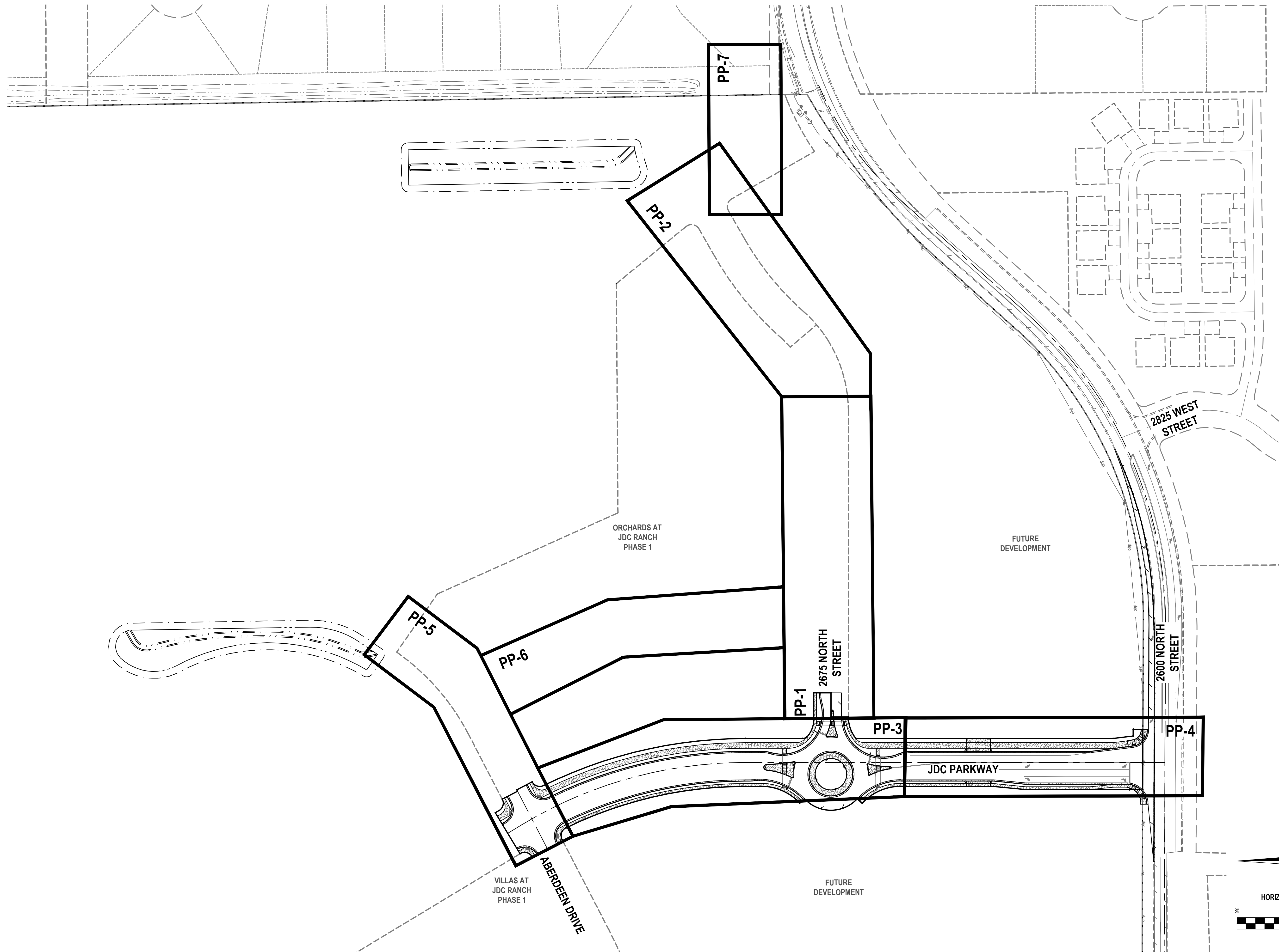

ENSIGN
THE STANDARD IN ENGINEERING

LAYTON
919 North 400 West
Layton, UT 84041
Phone: 801.547.1100

SANDY
Phone: 801.255.0529

TOOELE
Phone: 435.843.3590

CEDAR CITY
Phone: 435.865.1453

RICHFIELD
Phone: 435.896.2983

WWW.ENSIGNENG.COM

FOR:
NILSON HOVES
1740 COMBE RD, SUITE 2
SOUTH OGDEN, UT 84403

CONTACT:
STEVE ANDERSON
PHONE: 801.392.8100

JDC PARKWAY
2800 WEST 2600 NORTH STREET
WEBER COUNTY, UTAH

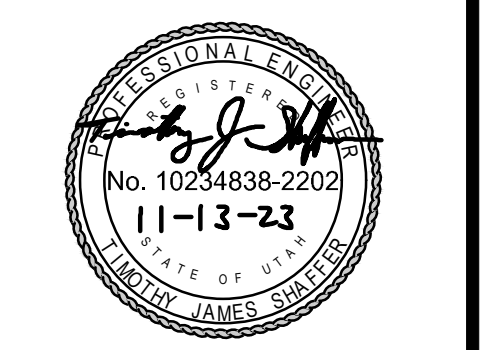

NO.	DATE	REVISION FOR REVIEW

PLAN AND PROFILE KEY MAP

PROJECT NUMBER: 9872
PROJECT MANAGER: CP

PRINT DATE: 2023-11-13
DESIGNED BY: TS

PP-0



CALL BLUESTAKES
@ 811 AT LEAST 48 HOURS
PRIOR TO THE
COMMENCEMENT OF ANY
CONSTRUCTION.

BENCHMARK

NORTHWEST CORNER OF SECTION 27
TOWNSHIP 7 NORTH, RANGE 2 WEST
SALT LAKE BASE AND MERIDIAN
ELEV = 4231.00'

SCOPE OF WORK:

PROVIDE, INSTALL AND/OR CONSTRUCT THE FOLLOWING PER THE SPECIFICATIONS GIVEN OR REFERENCED, THE DETAILS NOTED, AND/OR AS SHOWN ON THE CONSTRUCTION DRAWINGS:

- 1 INSTALL 8" C900 DR18 PVC CULINARY WATERLINE PER BONA VISTA WATER IMPROVEMENT STANDARDS AND SPECIFICATIONS
- 2 INSTALL 8" C900 DR18 PVC "PURPLE" SECONDARY WATERLINE PER PINEVIEW WATER SYSTEMS STANDARDS AND SPECIFICATIONS
- 3 FIELD LOCATE AND HOT TAP TO EXISTING CULINARY WATERLINE PER BONA VISTA WATER IMPROVEMENT STANDARDS AND SPECIFICATIONS
- 4 16" MJ X 10" FLG TEE PER PINEVIEW WATER SYSTEMS STANDARDS AND SPECIFICATIONS
- 5 INSTALL STREET LIGHT PER WEBER COUNTY STANDARDS AND SPECIFICATIONS. COORDINATE ALL PROPOSED STREET LIGHT LOCATIONS WITH WEBER COUNTY AND THE STREET LIGHT INSTALLATION WITH ROCKY MOUNTAIN POWER.
- 6 PLUG AND BLOCK FOR FUTURE CONNECTION
- 7 EXISTING POWER POLE
- 8 INSTALL 6" C900 CR18 PVC "PURPLE" SECONDARY WATERLINE PER PINEVIEW WATER SYSTEMS STANDARDS AND SPECIFICATIONS
- 9 INSTALL 10" C900 CR18 PVC "PURPLE" SECONDARY WATERLINE PER PINEVIEW WATER SYSTEMS STANDARDS AND SPECIFICATIONS

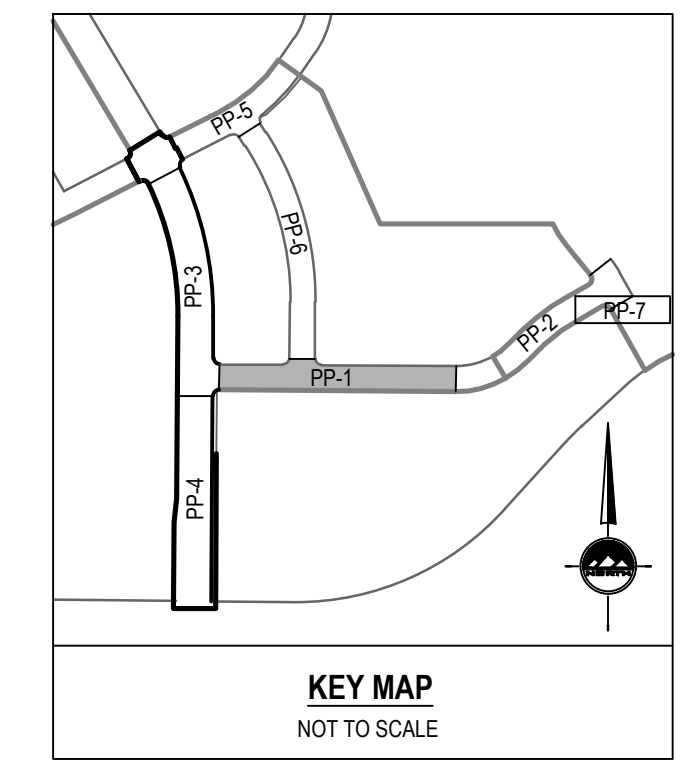

ENSIGN
THE STANDARD IN ENGINEERING

LAYTON
919 North 400 West
Layton, UT 84041
Phone: 801.547.1100

SANDY
Phone: 801.255.0529

TOOELE
Phone: 435.843.3590

CEDAR CITY
Phone: 435.865.1453

RICHFIELD
Phone: 435.896.2983

WWW.ENSIGNENG.COM

FOR:
NILSON HOMES
1740 COMBE RD, SUITE 2
SOUTH OGDEN, UT 84403

CONTACT:
STEVE ANDERSON
PHONE: 801.392.8100

JDC PARKWAY
2800 WEST 2600 NORTH STREET
WEBER COUNTY, UTAH



NO.	DATE	REVISION
		FOR REVIEW

OFFSITE UTILITY PLAN AND PROFILE

PROJECT NUMBER: 9872
PRINT DATE: 2023-11-13
PROJECT MANAGER: CP
DESIGNED BY: TS

PP-1

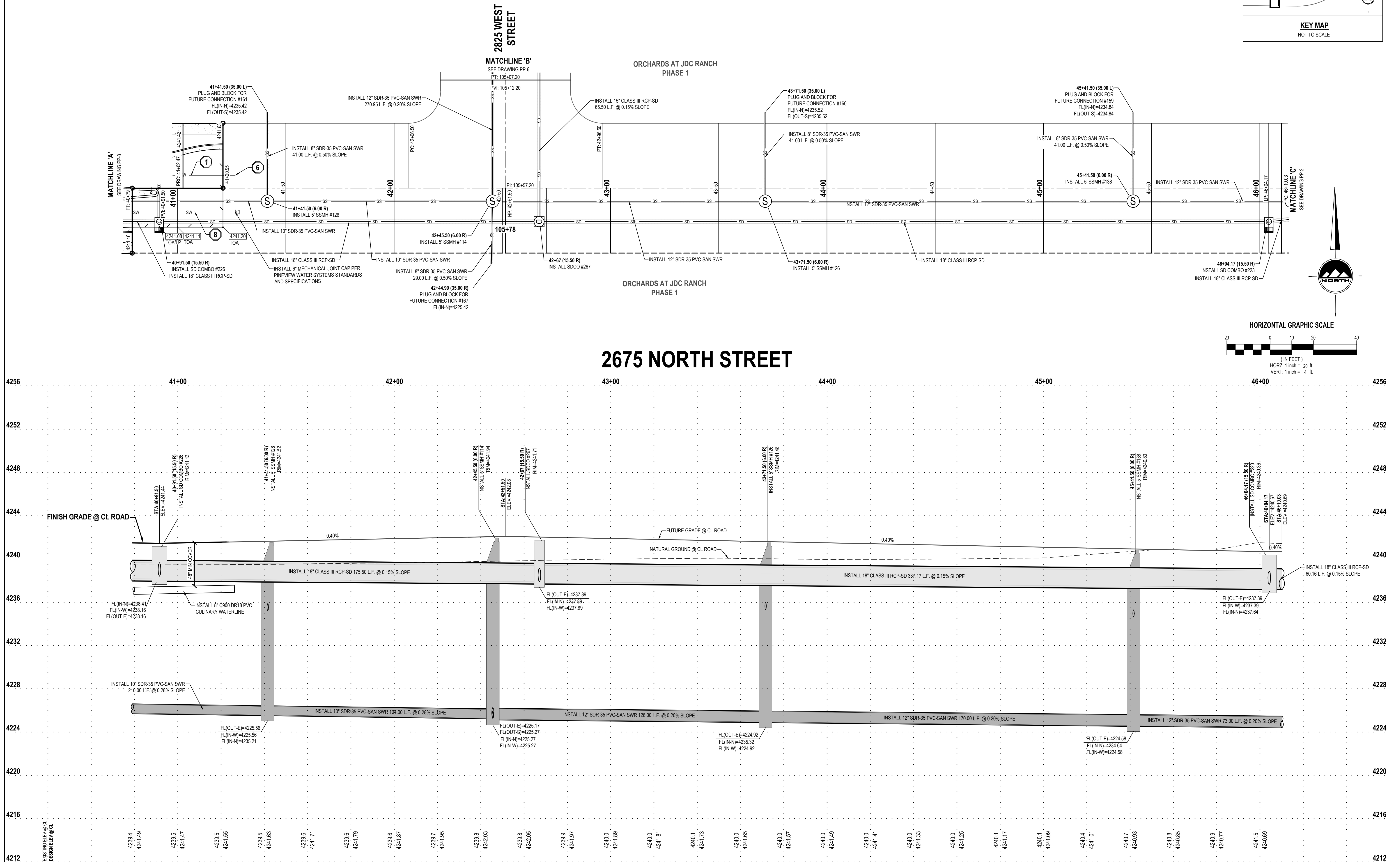

811
Know what's below.
Call before you dig.

CALL BLUESTAKES
@ 811 AT LEAST 48 HOURS
PRIOR TO THE
COMMENCEMENT OF ANY
CONSTRUCTION.

BENCHMARK

NORTHWEST CORNER OF SECTION 27
TOWNSHIP 7 NORTH, RANGE 2 WEST
SALT LAKE BASE AND MERIDIAN
ELEV = 4231.00'

- SCOPE OF WORK:**
PROVIDE, INSTALL AND/OR CONSTRUCT THE FOLLOWING PER THE SPECIFICATIONS GIVEN OR REFERENCED, THE DETAILS NOTED, AND/OR AS SHOWN ON THE CONSTRUCTION DRAWINGS.
1. INSTALL 8" C900 DR18 PVC CULINARY WATERLINE PER BONA VISTA WATER IMPROVEMENT STANDARDS AND SPECIFICATIONS
 2. INSTALL 8" C900 DR18 PVC "PURPLE" SECONDARY WATERLINE PER PINEVIEW WATER SYSTEMS STANDARDS AND SPECIFICATIONS
 3. FIELD LOCATE AND HOT TAP TO EXISTING CULINARY WATERLINE PER BONA VISTA WATER IMPROVEMENT STANDARDS AND SPECIFICATIONS
 4. 16" MJ X 10" FLG TEE PER PINEVIEW WATER SYSTEMS STANDARDS AND SPECIFICATIONS
 5. INSTALL STREET LIGHT PER WEBER COUNTY STANDARDS AND SPECIFICATIONS. COORDINATE ALL PROPOSED STREET LIGHT LOCATIONS WITH WEBER COUNTY AND THE STREET LIGHT INSTALLATION WITH ROCKY MOUNTAIN POWER.
 6. PLUG AND BLOCK FOR FUTURE CONNECTION
 7. EXISTING POWER POLE
 8. INSTALL 6" C900 CR18 PVC "PURPLE" SECONDARY WATERLINE PER PINEVIEW WATER SYSTEMS STANDARDS AND SPECIFICATIONS
 9. INSTALL 10" C900 CR18 PVC "PURPLE" SECONDARY WATERLINE PER PINEVIEW WATER SYSTEMS STANDARDS AND SPECIFICATIONS

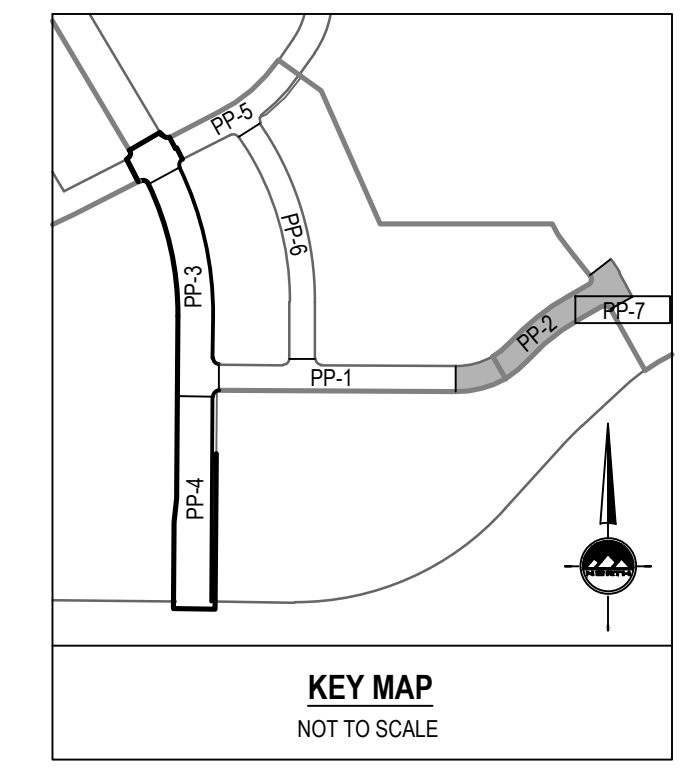

ENSIGN
THE STANDARD IN ENGINEERING

LAYTON
919 North 400 West
Layton, UT 84041
Phone: 801.547.1100

SANDY
Phone: 801.255.0529

TOOELE
Phone: 435.843.3590

CEDAR CITY
Phone: 435.865.1453

RICHFIELD
Phone: 435.896.2983

WWW.ENSIGNENG.COM

FOR:
NILSON HOMES
1740 COMBE RD, SUITE 2
SOUTH OGDEN, UT 84403

CONTACT:
STEVE ANDERSON
PHONE: 801.392.8100

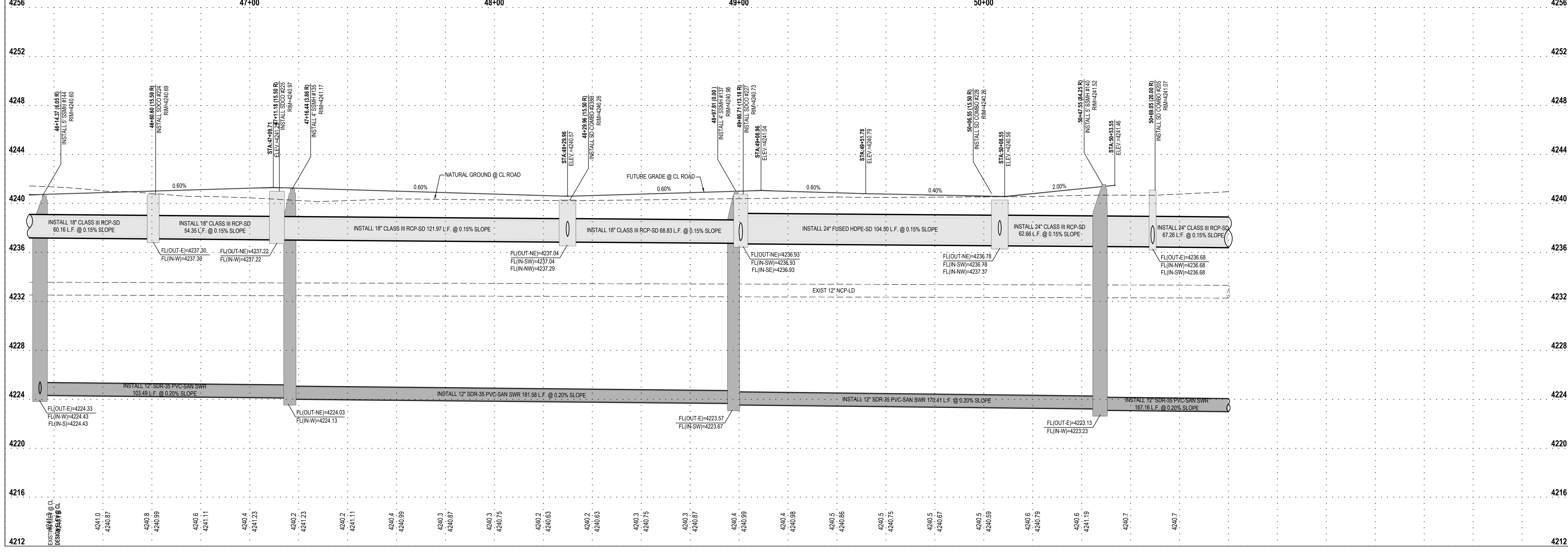
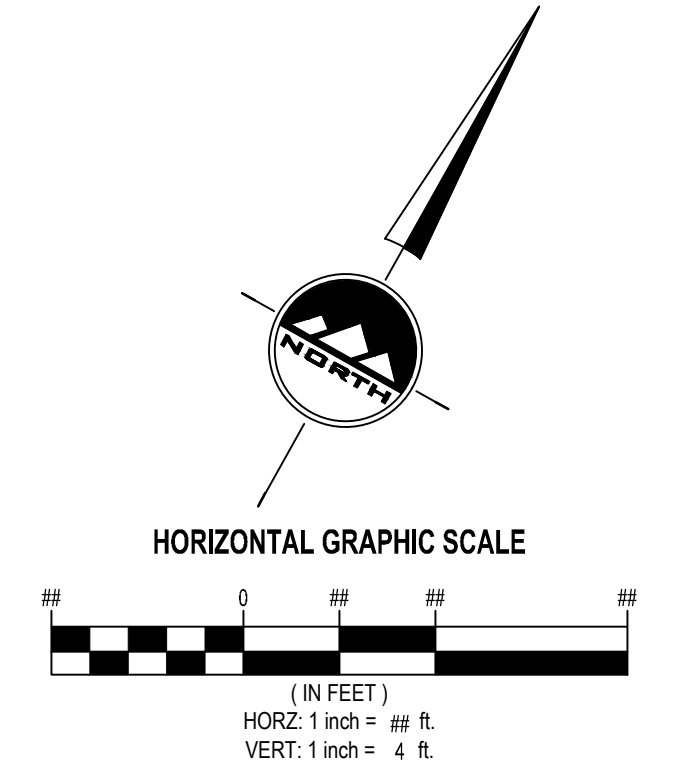
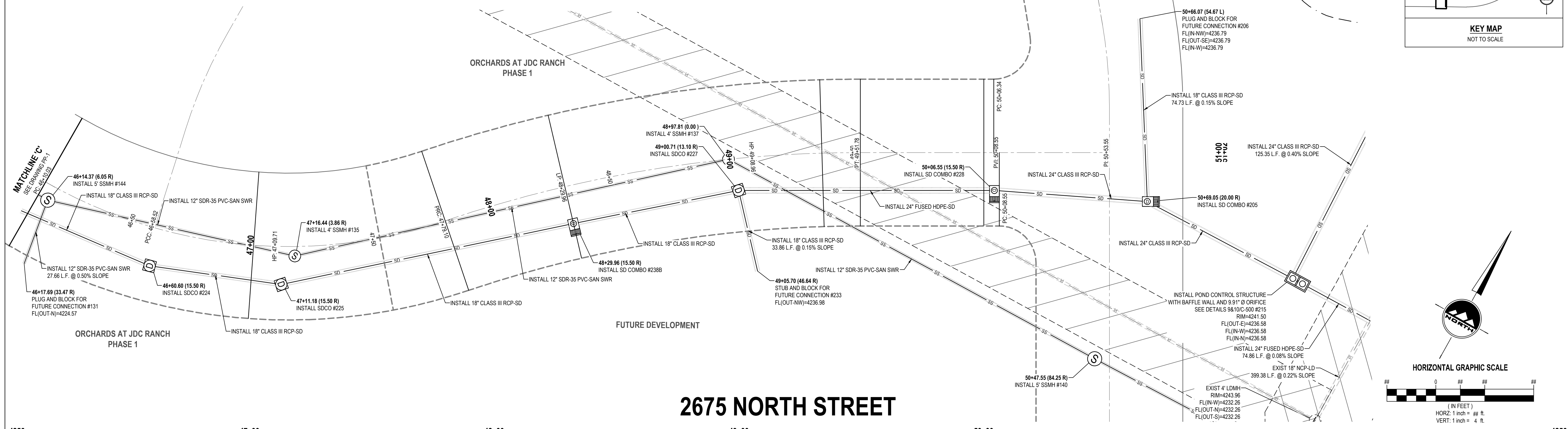

JDC PARKWAY

2800 WEST 2600 NORTH STREET

WEBER COUNTY, UTAH



NO.	DATE	REVISION
		FOR REVIEW

OFFSITE UTILITY PLAN AND PROFILE

PROJECT NUMBER	PRINT DATE
9872	2023-11-13
PROJECT MANAGER	DESIGNED BY
CP	TS

PP-2



BENCHMARK
 NORTHWEST CORNER OF SECTION 27
 TOWNSHIP 7 NORTH, RANGE 2 WEST
 SALT LAKE BASE AND MERIDIAN
 ELEV = 4231.00'

- SCOPE OF WORK:**
 PROVIDE, INSTALL AND/OR CONSTRUCT THE FOLLOWING PER THE SPECIFICATIONS GIVEN OR REFERENCED, THE DETAILS NOTED, AND/OR AS SHOWN ON THE CONSTRUCTION DRAWINGS:
1. INSTALL 8" C900 DR18 PVC CULINARY WATERLINE PER BONA VISTA WATER IMPROVEMENT STANDARDS AND SPECIFICATIONS
 2. INSTALL 8" C900 DR18 PVC "PURPLE" SECONDARY WATERLINE PER PINEVIEW WATER SYSTEMS STANDARDS AND SPECIFICATIONS
 3. FIELD LOCATE AND HOT TAP TO EXISTING CULINARY WATERLINE PER BONA VISTA WATER IMPROVEMENT STANDARDS AND SPECIFICATIONS
 4. 16" MJ X 10" FLG TEE PER PINEVIEW WATER SYSTEMS STANDARDS AND SPECIFICATIONS
 5. INSTALL STREET LIGHT PER WEBER COUNTY STANDARDS AND SPECIFICATIONS. COORDINATE ALL PROPOSED STREET LIGHT LOCATIONS WITH WEBER COUNTY AND THE STREET LIGHT INSTALLATION WITH ROCKY MOUNTAIN POWER.
 6. PLUG AND BLOCK FOR FUTURE CONNECTION
 7. EXISTING POWER POLE
 8. INSTALL 6" C900 CR18 PVC "PURPLE" SECONDARY WATERLINE PER PINEVIEW WATER SYSTEMS STANDARDS AND SPECIFICATIONS
 9. INSTALL 10" C900 CR18 PVC "PURPLE" SECONDARY WATERLINE PER PINEVIEW WATER SYSTEMS STANDARDS AND SPECIFICATIONS

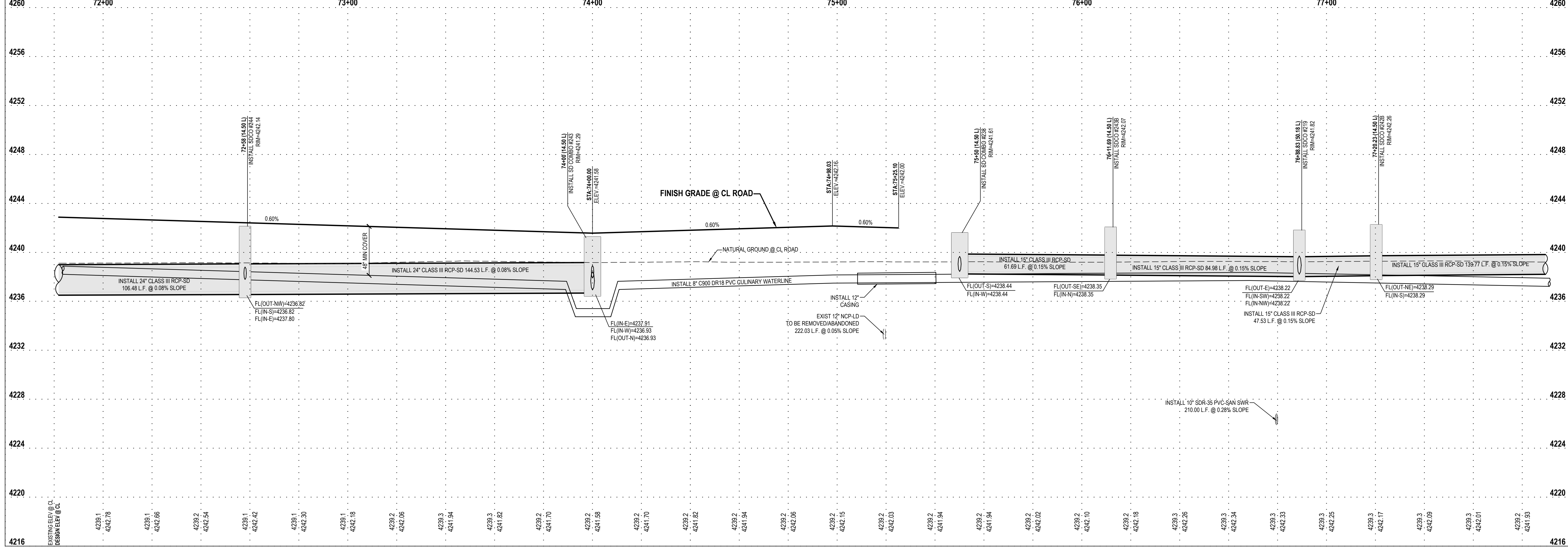
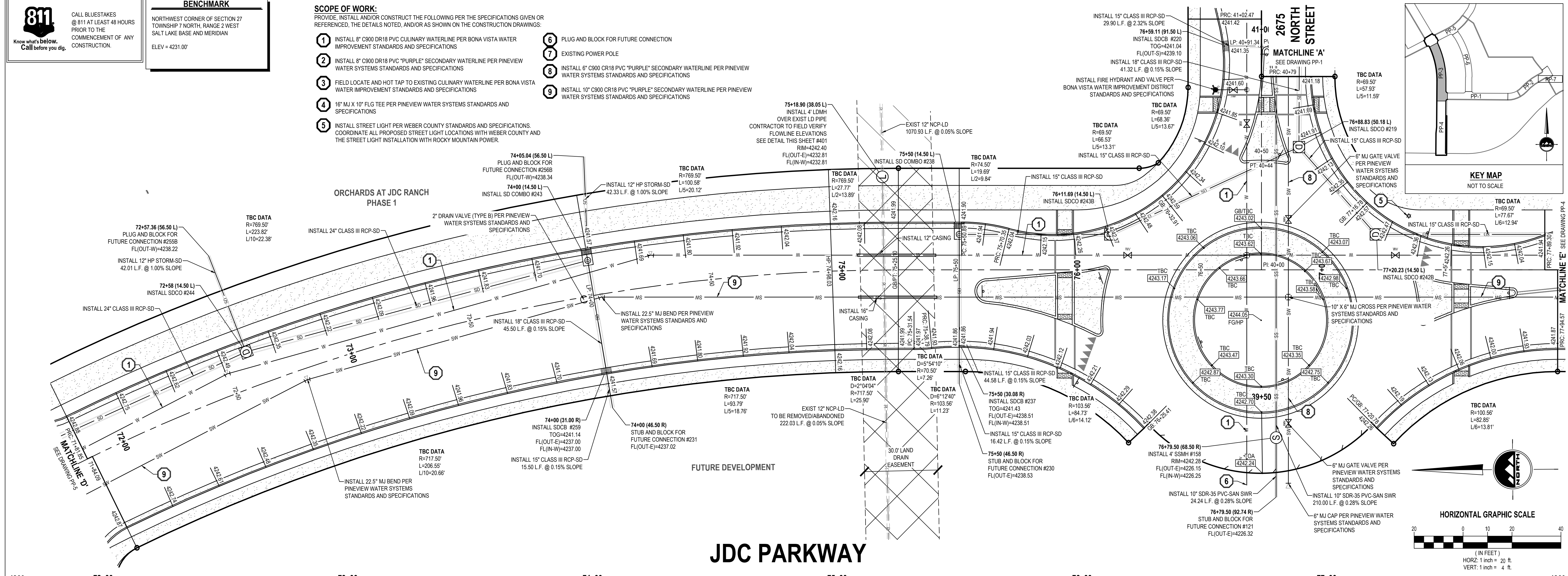

ENSIGN
 THE STANDARD IN ENGINEERING

LAYTON
 919 North 400 West
 Layton, UT 84041
 Phone: 801.547.1100

SANDY
 Phone: 801.255.0529

TOOELE
 Phone: 435.843.3590

CEDAR CITY
 Phone: 435.865.1453

RICHFIELD
 Phone: 435.896.2983

WWW.ENSIGNENG.COM

FOR:
 NILSON HOVES
 1740 COMBE RD, SUITE 2
 SOUTH OGDEN, UT 84403

CONTACT:
 STEVE ANDERSON
 PHONE: 801.382.8100

JDC PARKWAY
 2800 WEST 2600 NORTH STREET
 WEBER COUNTY, UTAH



NO. DATE REVISION FOR REVIEW

JDC PARKWAY
 PLAN AND PROFILE

PROJECT NUMBER 9872
 PROJECT MANAGER CP

PRINT DATE 2023-11-13
 DESIGNED BY TS

PP-3



CALL BLUESTAKES
@ 811 AT LEAST 48 HOURS
PRIOR TO THE
COMMENCEMENT OF ANY
CONSTRUCTION.

BENCHMARK

NORTHWEST CORNER OF SECTION 27
TOWNSHIP 7 NORTH, RANGE 2 WEST
SALT LAKE BASE AND MERIDIAN
ELEV = 4231.00'

SCOPE OF WORK:

PROVIDE, INSTALL AND/OR CONSTRUCT THE FOLLOWING PER THE SPECIFICATIONS GIVEN OR REFERENCED, THE DETAILS NOTED, AND/OR AS SHOWN ON THE CONSTRUCTION DRAWINGS:

- 1 INSTALL 8" C900 DR18 PVC CULINARY WATERLINE PER BONA VISTA WATER IMPROVEMENT STANDARDS AND SPECIFICATIONS
- 2 INSTALL 8" C900 DR18 PVC "PURPLE" SECONDARY WATERLINE PER PINEVIEW WATER SYSTEMS STANDARDS AND SPECIFICATIONS
- 3 FIELD LOCATE AND HOT TAP TO EXISTING CULINARY WATERLINE PER BONA VISTA WATER IMPROVEMENT STANDARDS AND SPECIFICATIONS
- 4 16" MJ X 10" FLG TEE PER PINEVIEW WATER SYSTEMS STANDARDS AND SPECIFICATIONS
- 5 INSTALL STREET LIGHT PER WEBER COUNTY STANDARDS AND SPECIFICATIONS. COORDINATE ALL PROPOSED STREET LIGHT LOCATIONS WITH WEBER COUNTY AND THE STREET LIGHT INSTALLATION WITH ROCKY MOUNTAIN POWER.
- 6 PLUG AND BLOCK FOR FUTURE CONNECTION
- 7 EXISTING POWER POLE
- 8 INSTALL 6" C900 CR18 PVC "PURPLE" SECONDARY WATERLINE PER PINEVIEW WATER SYSTEMS STANDARDS AND SPECIFICATIONS
- 9 INSTALL 10" C900 CR18 PVC "PURPLE" SECONDARY WATERLINE PER PINEVIEW WATER SYSTEMS STANDARDS AND SPECIFICATIONS

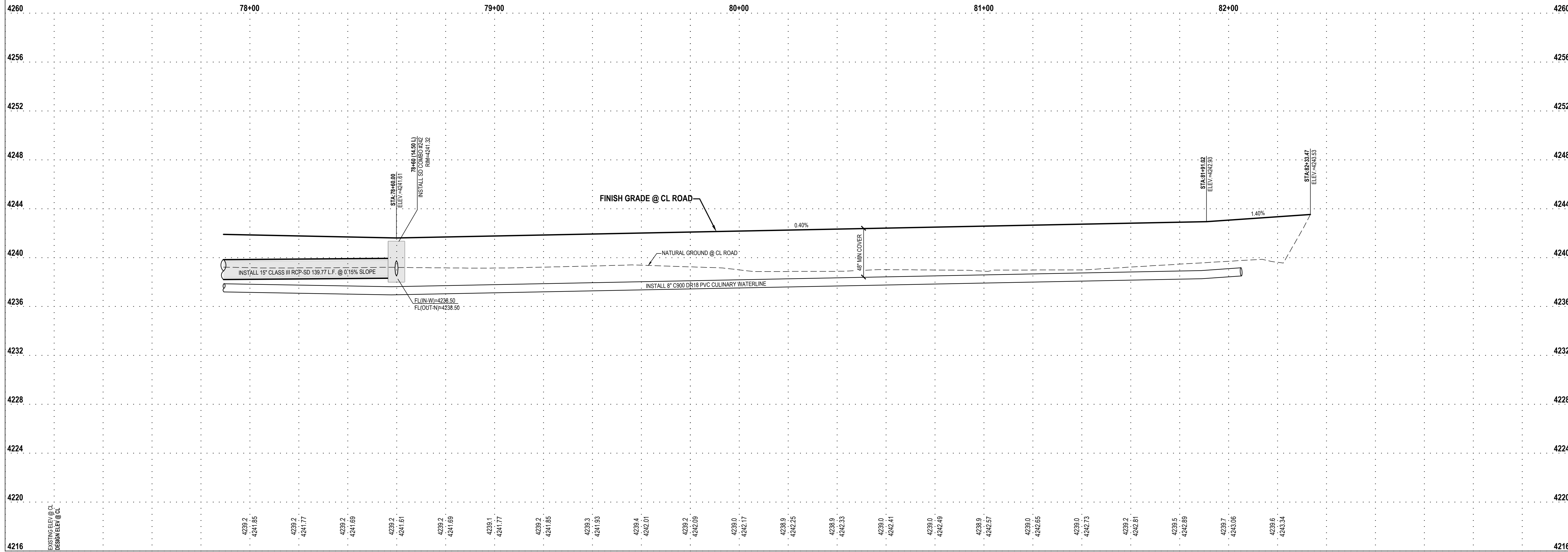
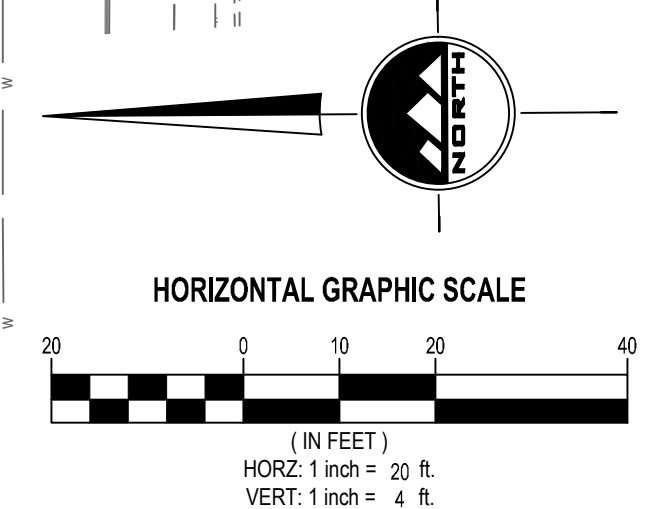
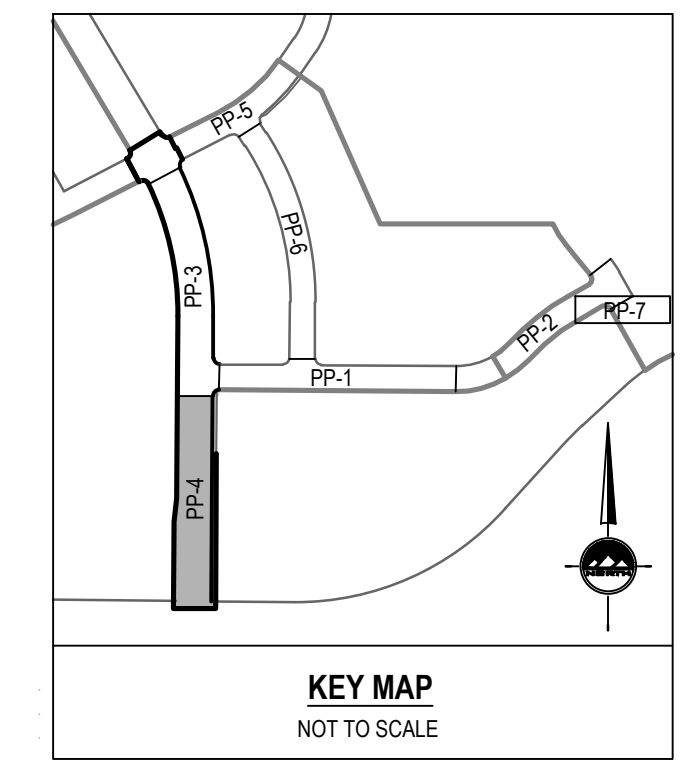
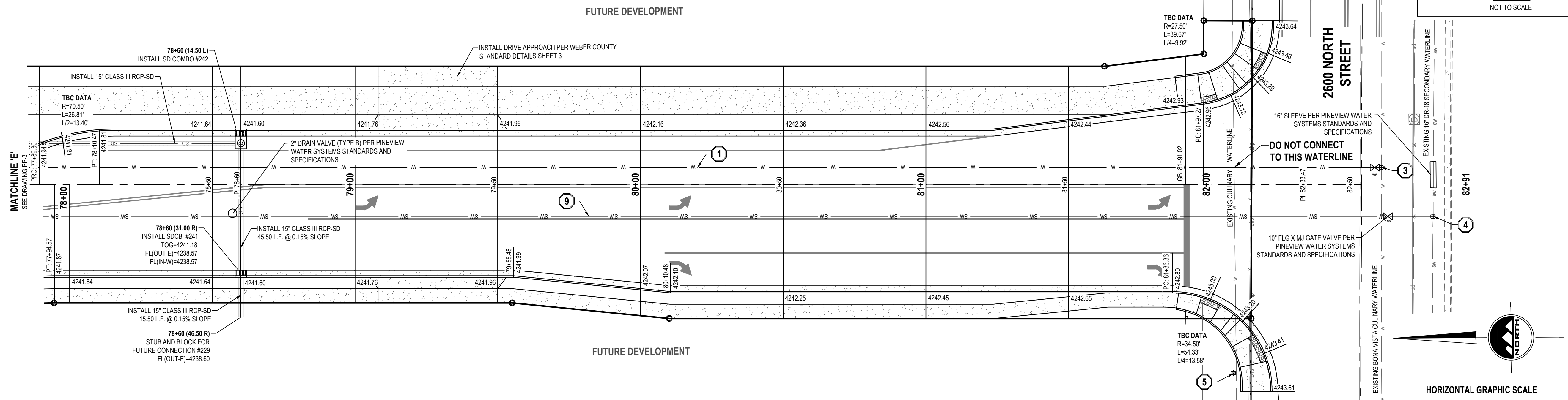

ENSIGN
THE STANDARD IN ENGINEERING

LAYTON
919 North 400 West
Layton, UT 84041
Phone: 801.547.1100

SANDY
Phone: 801.255.0529

TOOELE
Phone: 435.843.3590

CEDAR CITY
Phone: 435.865.1453

RICHFIELD
Phone: 435.896.2983

WWW.ENSIGNENG.COM

FOR:
NILSON HOVES
1740 COMBE RD, SUITE 2
SOUTH OGDEN, UT 84403

CONTACT:
STEVE ANDERSON
PHONE: 801.392.8100

JDC PARKWAY
2800 WEST 2600 NORTH STREET
WEBER COUNTY, UTAH



NO.	DATE	REVISION FOR REVIEW

JDC PARKWAY
PLAN AND PROFILE

PROJECT NUMBER: 9872
PRINT DATE: 2023-11-13
PROJECT MANAGER: CP
DESIGNED BY: TS

PP-4

BENCHMARK

NORTHWEST CORNER OF SECTION 27 TOWNSHIP 7 NORTH, RANGE 2 WEST SALT LAKE BASE AND MERIDIAN ELEV = 4231.00'

SCOPE OF WORK:

PROVIDE, INSTALL AND/OR CONSTRUCT THE FOLLOWING PER THE SPECIFICATIONS GIVEN OR REFERENCED, THE DETAILS NOTED, AND/OR AS SHOWN ON THE CONSTRUCTION DRAWINGS:

- 1 INSTALL 8" C900 DR18 PVC CULINARY WATERLINE PER BONA VISTA WATER IMPROVEMENT STANDARDS AND SPECIFICATIONS
2 INSTALL 8" C900 DR18 PVC 'PURPLE' SECONDARY WATERLINE PER PINEVIEW WATER SYSTEMS STANDARDS AND SPECIFICATIONS
3 FIELD LOCATE AND HOT TAP TO EXISTING CULINARY WATERLINE PER BONA VISTA WATER IMPROVEMENT STANDARDS AND SPECIFICATIONS
4 16" MU X 10" FLG TEE PER PINEVIEW WATER SYSTEMS STANDARDS AND SPECIFICATIONS
5 INSTALL STREET LIGHT PER WEBER COUNTY STANDARDS AND SPECIFICATIONS. COORDINATE ALL PROPOSED STREET LIGHT LOCATIONS WITH WEBER COUNTY AND THE STREET LIGHT INSTALLATION WITH ROCKY MOUNTAIN POWER.
6 PLUG AND BLOCK FOR FUTURE CONNECTION
7 EXISTING POWER POLE
8 INSTALL 6" C900 CR18 PVC 'PURPLE' SECONDARY WATERLINE PER PINEVIEW WATER SYSTEMS STANDARDS AND SPECIFICATIONS
9 INSTALL 10" C900 CR18 PVC 'PURPLE' SECONDARY WATERLINE PER PINEVIEW WATER SYSTEMS STANDARDS AND SPECIFICATIONS

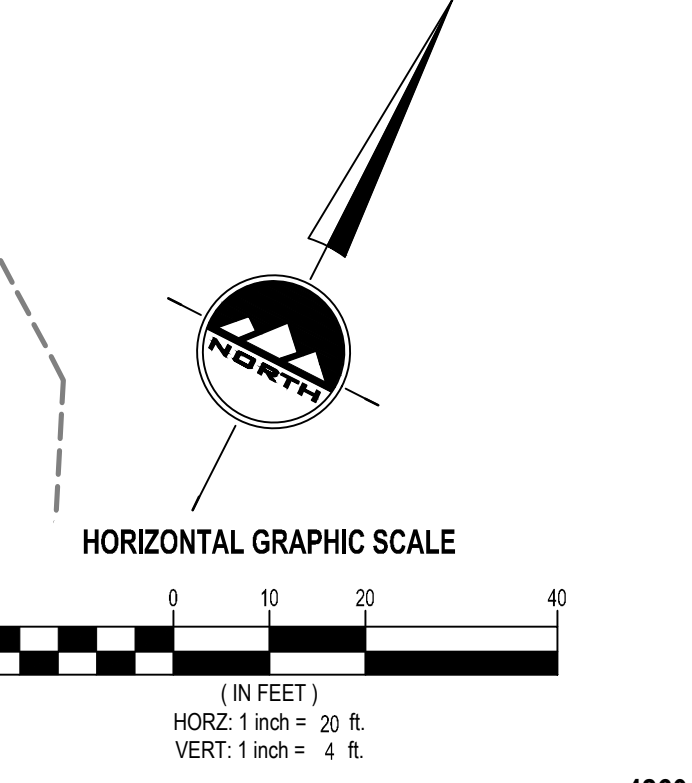
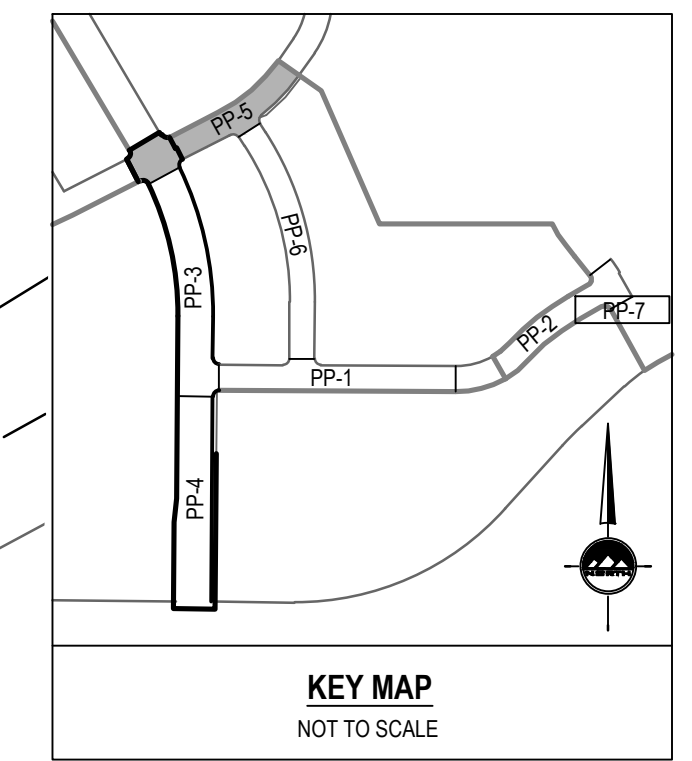
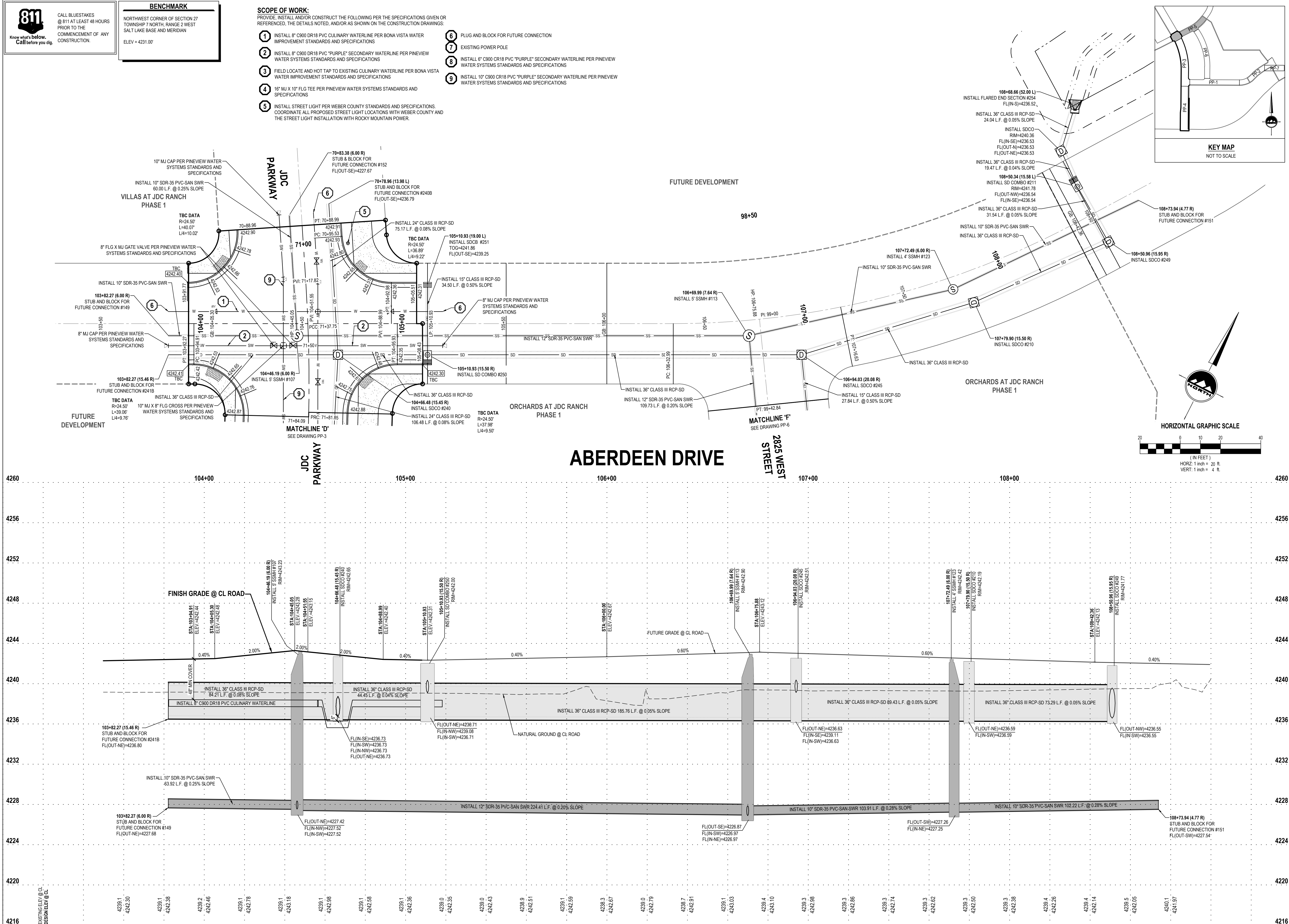

ENSIGN THE STANDARD IN ENGINEERING
LAYTON 919 North 400 West Layton, UT 84041 Phone: 801.547.1100
SANDY Phone: 801.255.0529
TOOELE Phone: 435.843.3590
CEDAR CITY Phone: 435.865.1453
RICHFIELD Phone: 435.896.2983
WWW.ENSIGNENG.COM

FOR: NILSON HOMES 1740 COMBE RD. SUITE 2 SOUTH OGDEN, UT 84403
CONTACT: STEVE ANDERSON PHONE: 801.392.8100

JDC PARKWAY
2800 WEST 2600 NORTH STREET
WEBER COUNTY, UTAH



Table with columns: NO., DATE, REVISION, FOR REVIEW

ABERDEEN DRIVE PLAN AND PROFILE

PROJECT NUMBER 9872 PRINT DATE 2023-11-13
PROJECT MANAGER CP DESIGNED BY TS



CALL BLUESTAKES
@ 811 AT LEAST 48 HOURS
PRIOR TO THE
COMMENCEMENT OF ANY
CONSTRUCTION.

BENCHMARK

NORTHWEST CORNER OF SECTION 27
TOWNSHIP 7 NORTH, RANGE 2 WEST
SALT LAKE BASE AND MERIDIAN
ELEV = 4231.00'

SCOPE OF WORK:

PROVIDE, INSTALL AND/OR CONSTRUCT THE FOLLOWING PER THE SPECIFICATIONS GIVEN OR REFERENCED, THE DETAILS NOTED, AND/OR AS SHOWN ON THE CONSTRUCTION DRAWINGS:

- 1 INSTALL 8" C900 DR18 PVC CULINARY WATERLINE PER BONA VISTA WATER IMPROVEMENT STANDARDS AND SPECIFICATIONS
- 2 INSTALL 8" C900 DR18 PVC "PURPLE" SECONDARY WATERLINE PER PINEVIEW WATER SYSTEMS STANDARDS AND SPECIFICATIONS
- 3 FIELD LOCATE AND HOT TAP TO EXISTING CULINARY WATERLINE PER BONA VISTA WATER IMPROVEMENT STANDARDS AND SPECIFICATIONS
- 4 16" MJ X 10" FLG TEE PER PINEVIEW WATER SYSTEMS STANDARDS AND SPECIFICATIONS
- 5 INSTALL STREET LIGHT PER WEBER COUNTY STANDARDS AND SPECIFICATIONS. COORDINATE ALL PROPOSED STREET LIGHT LOCATIONS WITH WEBER COUNTY AND THE STREET LIGHT INSTALLATION WITH ROCKY MOUNTAIN POWER.
- 6 PLUG AND BLOCK FOR FUTURE CONNECTION
- 7 EXISTING POWER POLE
- 8 INSTALL 6" C900 CR18 PVC "PURPLE" SECONDARY WATERLINE PER PINEVIEW WATER SYSTEMS STANDARDS AND SPECIFICATIONS
- 9 INSTALL 10" C900 CR18 PVC "PURPLE" SECONDARY WATERLINE PER PINEVIEW WATER SYSTEMS STANDARDS AND SPECIFICATIONS

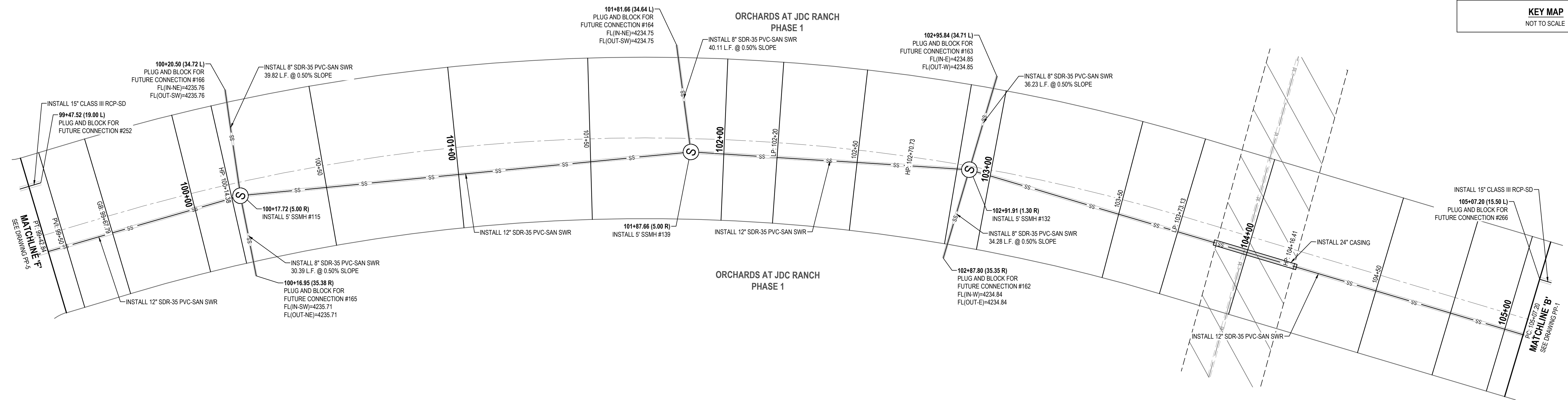
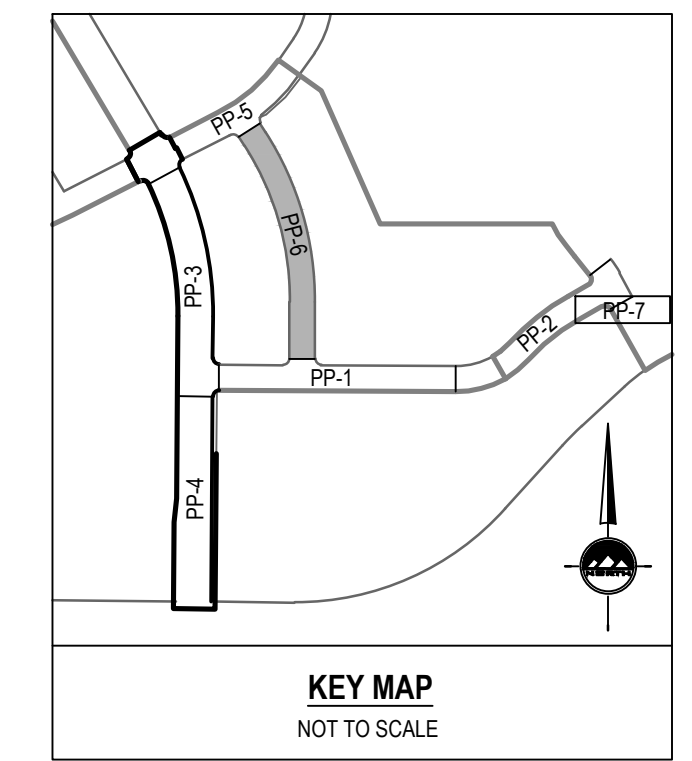
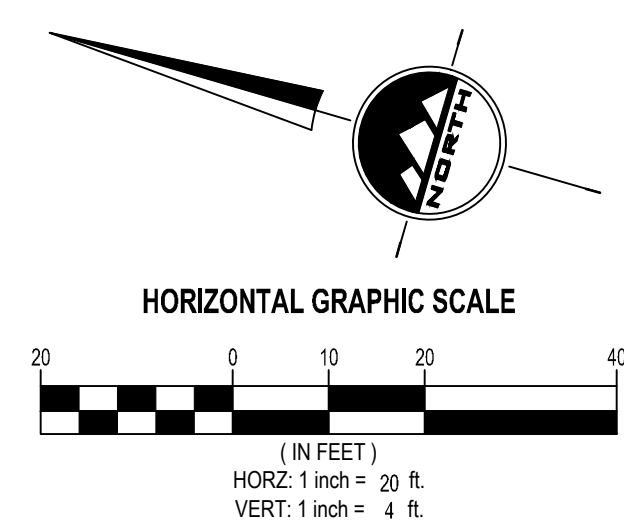

2825 WEST STREET

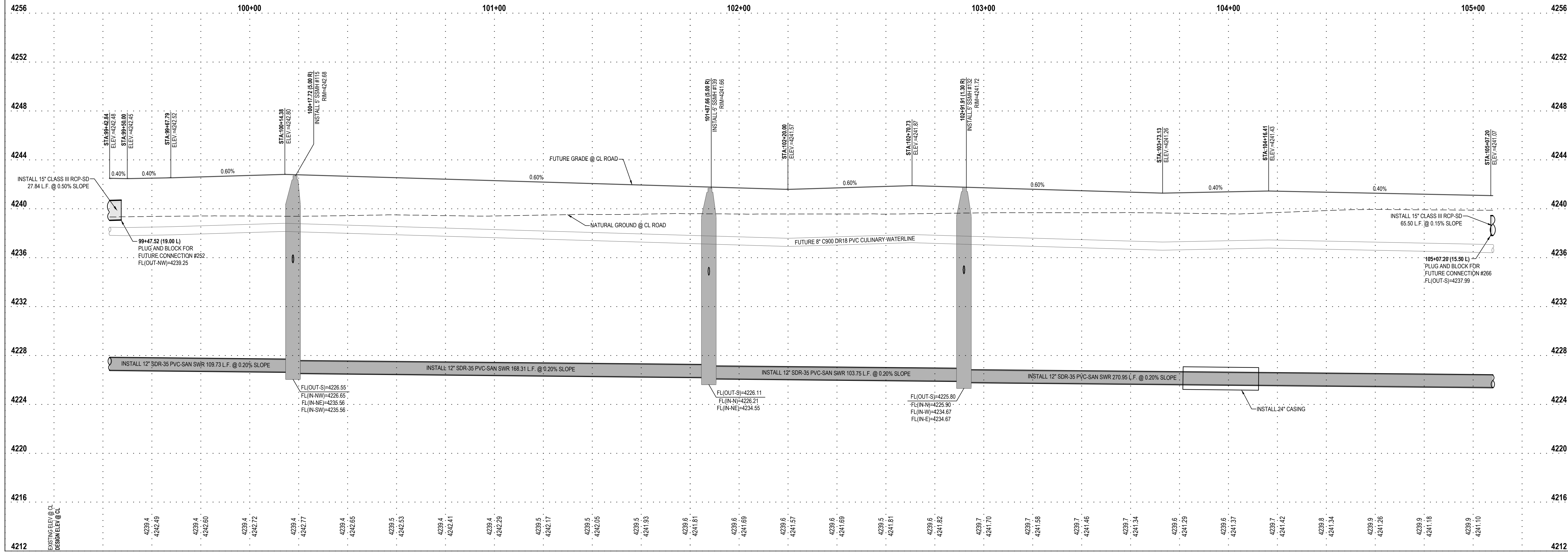

ENSIGN
THE STANDARD IN ENGINEERING

LAYTON
919 North 400 West
Layton, UT 84041
Phone: 801.547.1100

SANDY
Phone: 801.255.0529

TOOELE
Phone: 435.843.3590

CEDAR CITY
Phone: 435.865.1453

RICHFIELD
Phone: 435.896.2983

WWW.ENSIGNENG.COM

FOR:
NILSON HOMES
1740 COMBE RD, SUITE 2
SOUTH OGDEN, UT 84403

CONTACT:
STEVE ANDERSON
PHONE: 801.392.8100

JDC PARKWAY

2800 WEST 2600 NORTH STREET

WEBER COUNTY, UTAH



NO.	DATE	REVISION
		FOR REVIEW

**OFFSITE UTILITY
PLAN AND PROFILE**

PROJECT NUMBER: 9872
PRINT DATE: 2023-11-13
PROJECT MANAGER: CP
DESIGNED BY: TS

PP-6



BENCHMARK
 NORTHWEST CORNER OF SECTION 27
 TOWNSHIP 7 NORTH, RANGE 2 WEST
 SALT LAKE BASE AND MERIDIAN
 ELEV = 4231.00'

- SCOPE OF WORK:**
 PROVIDE, INSTALL AND/OR CONSTRUCT THE FOLLOWING PER THE SPECIFICATIONS GIVEN OR REFERENCED, THE DETAILS NOTED, AND/OR AS SHOWN ON THE CONSTRUCTION DRAWINGS:
1. INSTALL 8" C900 DR18 PVC CULINARY WATERLINE PER BONA VISTA WATER IMPROVEMENT STANDARDS AND SPECIFICATIONS
 2. INSTALL 8" C900 DR18 PVC "PURPLE" SECONDARY WATERLINE PER PINEVIEW WATER SYSTEMS STANDARDS AND SPECIFICATIONS
 3. FIELD LOCATE AND HOT TAP TO EXISTING CULINARY WATERLINE PER BONA VISTA WATER IMPROVEMENT STANDARDS AND SPECIFICATIONS
 4. 16" MJ X 10" FLG TEE PER PINEVIEW WATER SYSTEMS STANDARDS AND SPECIFICATIONS
 5. INSTALL STREET LIGHT PER WEBER COUNTY STANDARDS AND SPECIFICATIONS. COORDINATE ALL PROPOSED STREET LIGHT LOCATIONS WITH WEBER COUNTY AND THE STREET LIGHT INSTALLATION WITH ROCKY MOUNTAIN POWER.
 6. PLUG AND BLOCK FOR FUTURE CONNECTION
 7. EXISTING POWER POLE
 8. INSTALL 6" C900 CR18 PVC "PURPLE" SECONDARY WATERLINE PER PINEVIEW WATER SYSTEMS STANDARDS AND SPECIFICATIONS
 9. INSTALL 10" C900 CR18 PVC "PURPLE" SECONDARY WATERLINE PER PINEVIEW WATER SYSTEMS STANDARDS AND SPECIFICATIONS

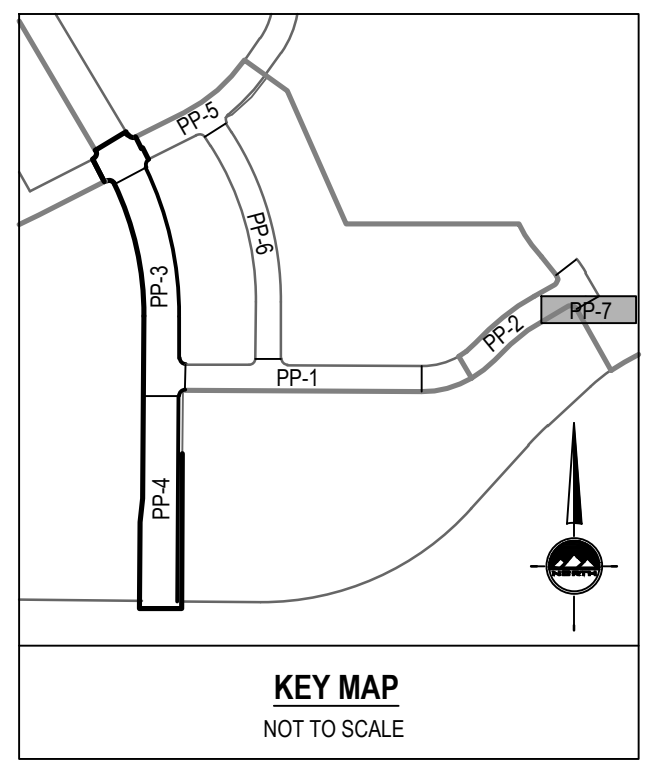
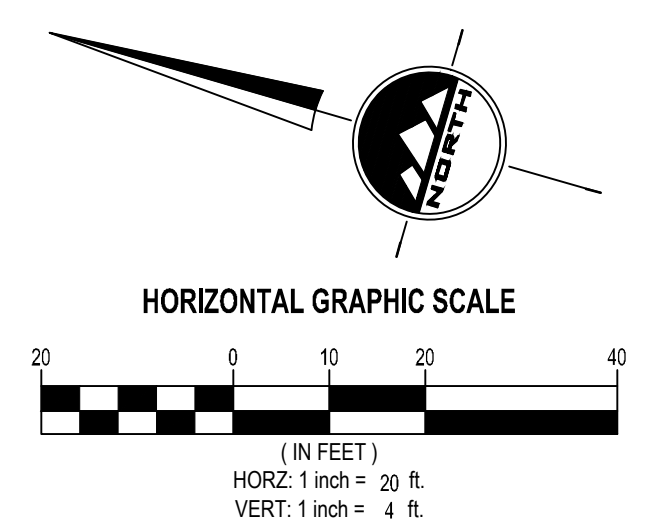

ENSIGN
 THE STANDARD IN ENGINEERING

LAYTON
 919 North 400 West
 Layton, UT 84041
 Phone: 801.547.1100

SANDY
 Phone: 801.255.0529

TOOELE
 Phone: 435.843.3590

CEDAR CITY
 Phone: 435.865.1453

RICHFIELD
 Phone: 435.896.2983

WWW.ENSIGNENG.COM

FOR:
 NILSON HOVES
 1740 COMBE RD, SUITE 2
 SOUTH OGDEN, UT 84403

CONTACT:
 STEVE ANDERSON
 PHONE: 801.392.8100

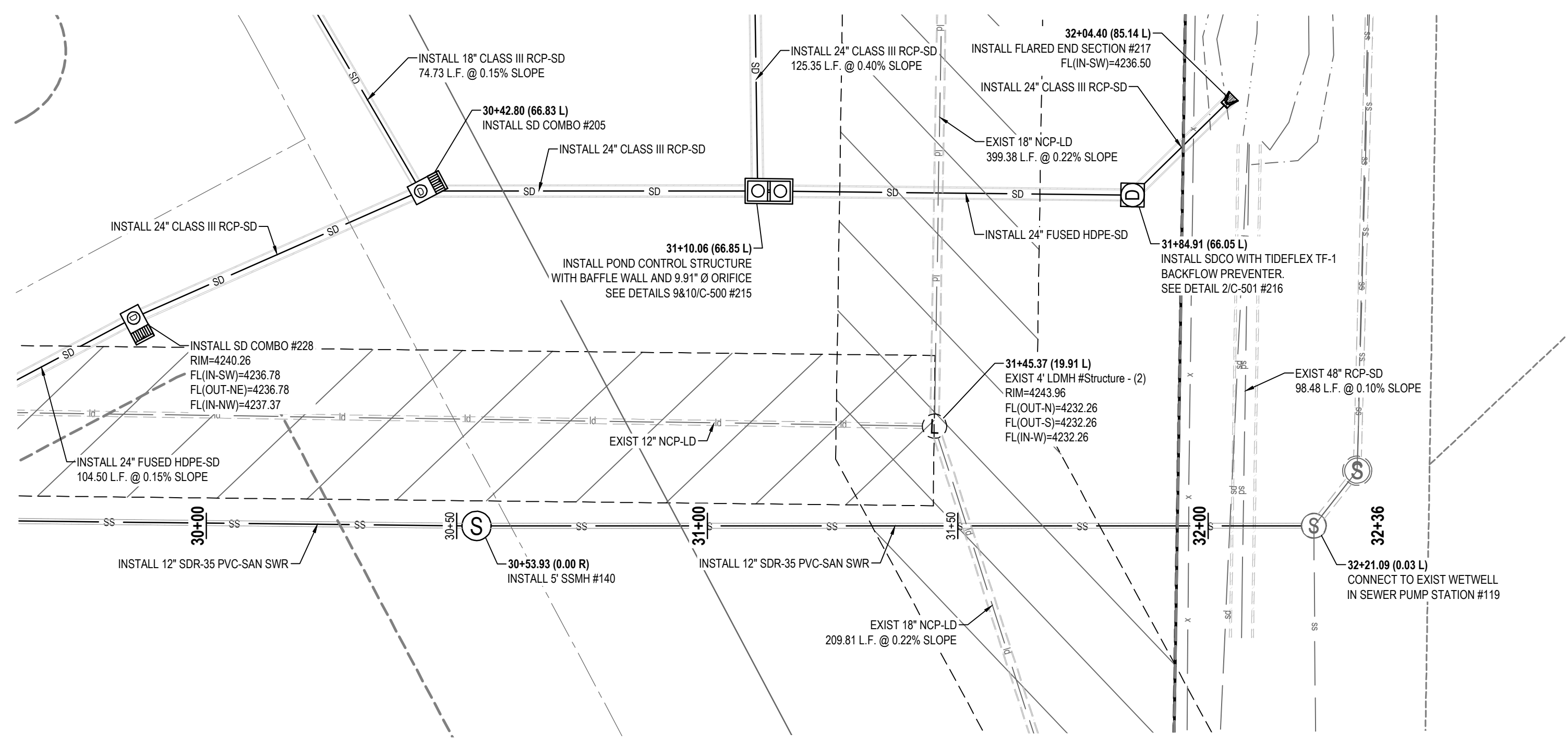

OFFSITE UTILITY

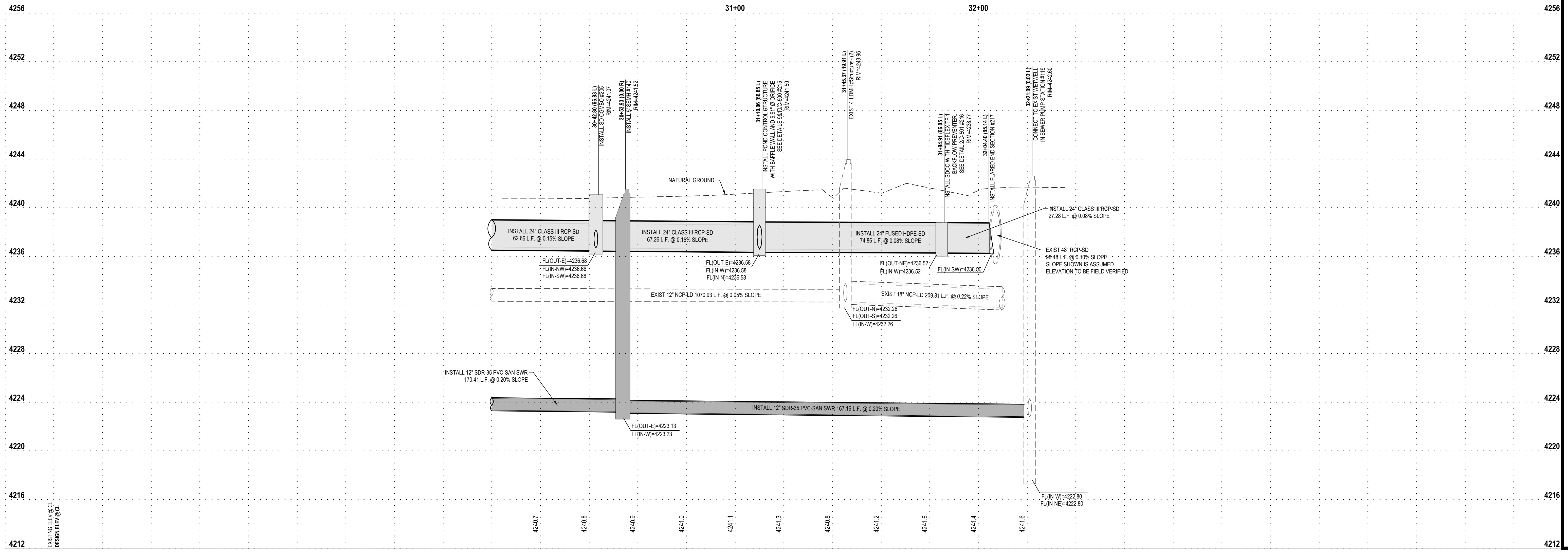

JDC PARKWAY

2800 WEST 2600 NORTH STREET

WEBER COUNTY, UTAH



NO.	DATE	REVISION FOR REVIEW

OFFSITE UTILITY PLAN AND PROFILE

PROJECT NUMBER: 9872
 PRINT DATE: 2023-11-13
 PROJECT MANAGER: CP
 DESIGNED BY: TS

PP-7

ENGINERS REVIEW @ C.C. BISHOP/ENR @ U.C.

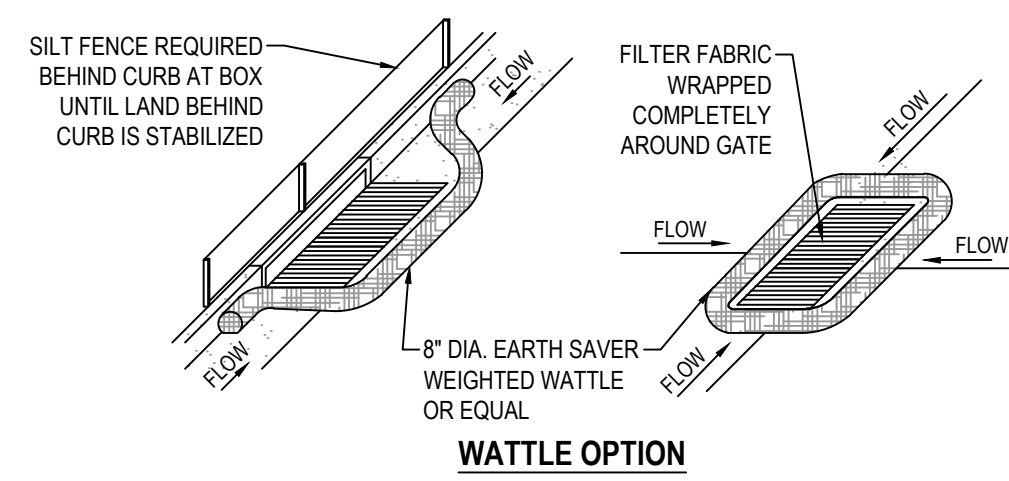

- NOTES:**
1. PLACE WATTLES OR GRAVEL BAGS TIGHT AGAINST CURB TO PREVENT SEDIMENT-LOADED WATER FROM GETTING BETWEEN CURB AND WATTLEBAG.
 2. PLACE WATTLES OR GRAVEL BAGS SUCH THAT FLOW DOES NOT OVERTOP CURB OR ROAD CENTERLINE.
 3. INSPECT INLET PROTECTION AFTER EVERY LARGE STORM EVENT AND AT LEAST BIWEEKLY, OR PER SWPPP REQUIREMENTS, WHICHEVER IS MORE STRINGENT, TO ENSURE THAT SEDIMENT CONTROL IS MEETING ITS DESIGN INTENT. MAINTAIN AND/OR REPLACE AS NEEDED.
 4. REMOVE SEDIMENT ACCUMULATED WHEN IT REACHES 50% OF GRAVEL BAG OR WATTLE HEIGHT.
 5. CONTRACTOR MAY SUBMIT AN ALTERNATIVE METHOD OF INLET PROTECTION. THE ALTERNATIVE METHOD SHALL BE APPROVED BY THE CITY INSPECTOR AND THE ENGINEER OF RECORD.
 6. BEFORE PLACEMENT OF CURB, STABILIZATION OF LAND BEHIND CURB, AND/OR PAVING, MAINTAIN TOP OF INLET AT 6" ABOVE GRADE, AND SURROUND WITH SILT FENCE FOR SEDIMENTATION AROUND BOX. MAINTAIN SILT FENCE BEHIND BOX UNTIL LAND BEHIND CURB IS STABILIZED.

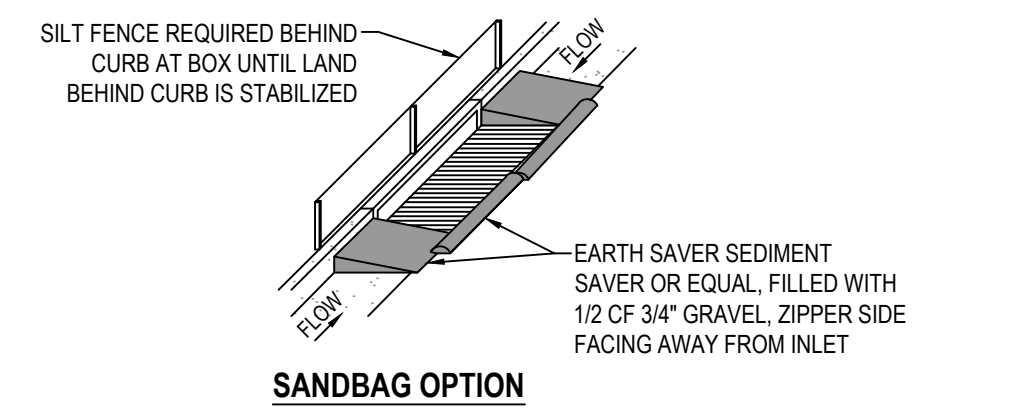

1 SAG INLET PROTECTION

SCALE: NONE

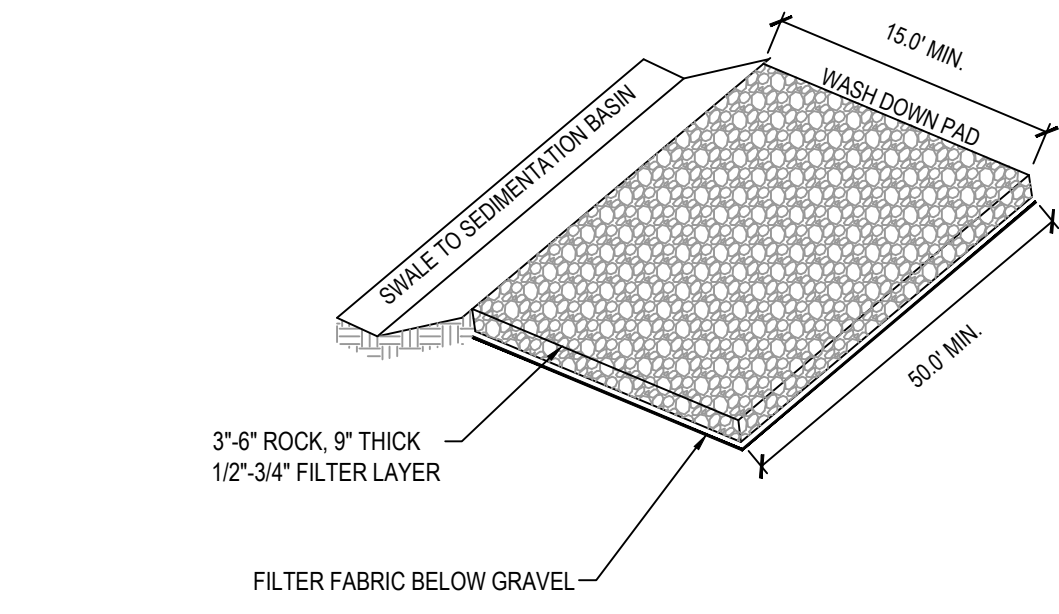

- NOTE:**
1. PLACE SIGN ADJACENT TO ENTRANCE - CONSTRUCTION TRAFFIC ONLY - ALL CONSTRUCTION TRAFFIC SHALL ENTER AND EXIT SITE AT THIS LOCATION

2 STABILIZED CONSTRUCTION ENTRANCE

SCALE: NONE

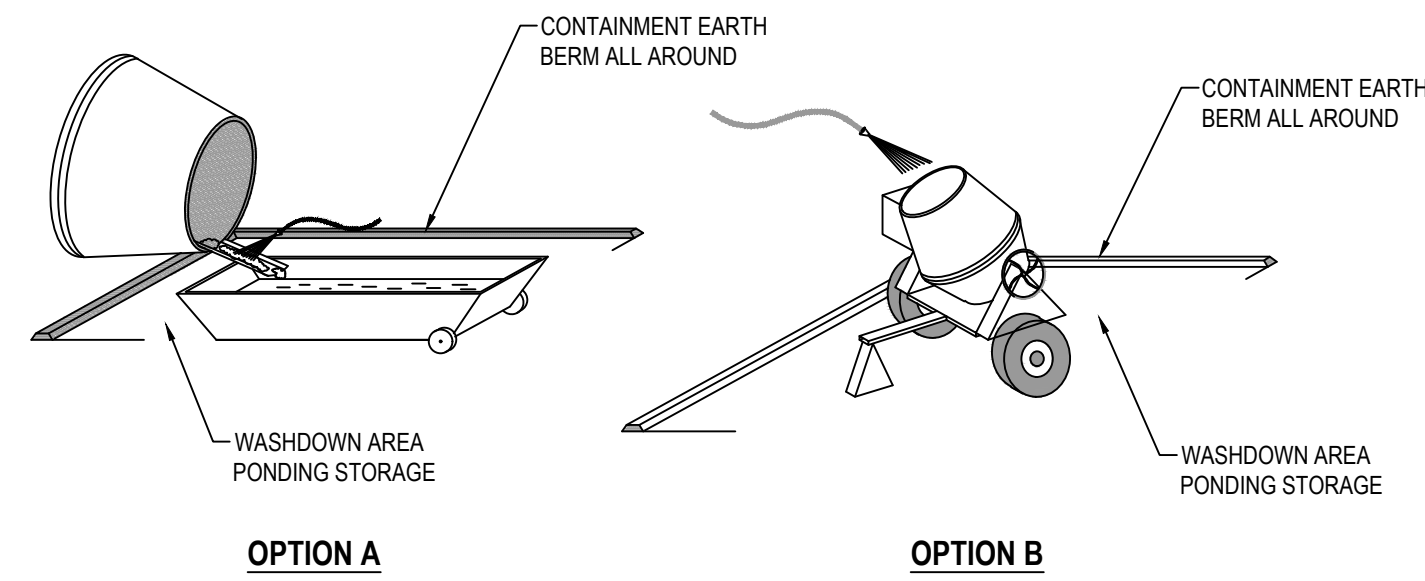

3 CONCRETE WASTE MANAGEMENT

SCALE: NONE

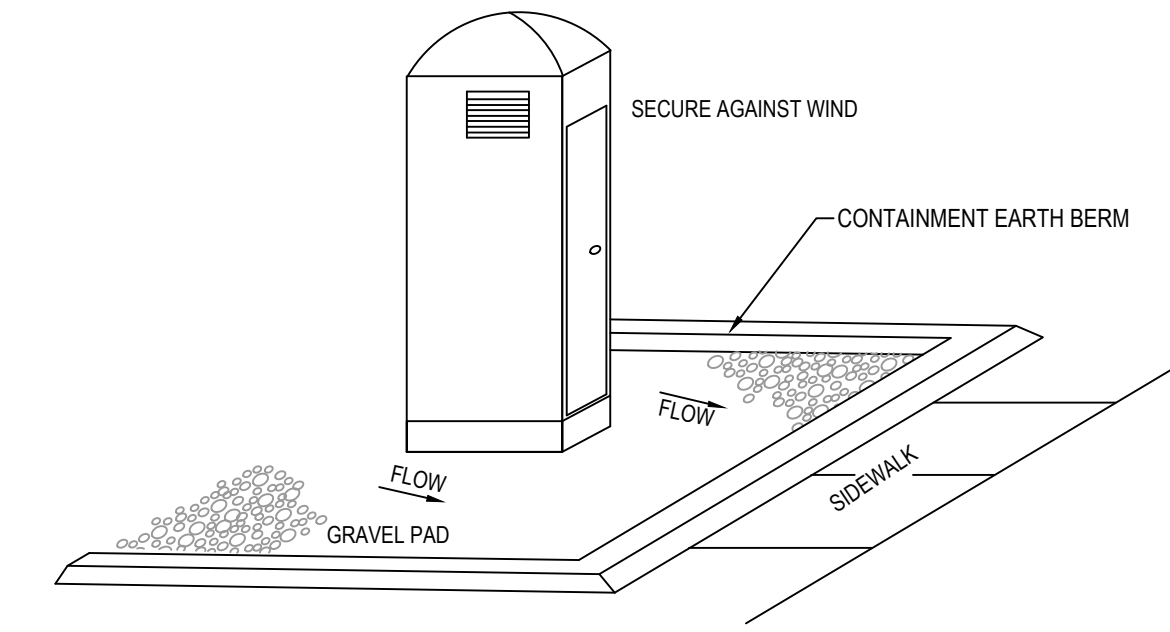

4 PORTABLE TOILET

SCALE: NONE

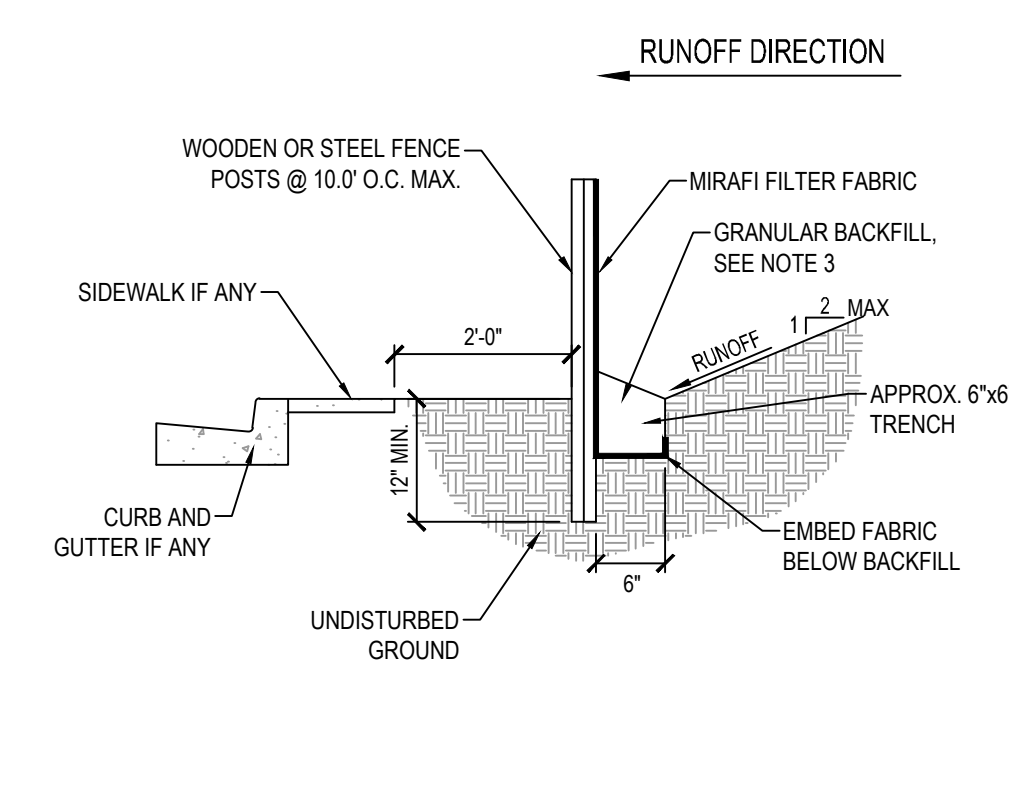

- NOTES:**
1. EXCAVATE 6"x6" TRENCH ALONG LIMITS OF DISTURBANCE AS SHOWN ON CONSTRUCTION DRAWINGS.
 2. POSTS SHALL BE POSITIONED ON DOWNSTREAM SIDE OF FENCE.
 3. LAY TOE-IN FABRIC FLAP IN BOTTOM OF TRENCH. BACKFILL TRENCH WITH FREE DRAINING GRANULAR MATERIAL. COMPACT TRENCH TO SATISFACTION OF THE ENGINEER OF RECORD.
 4. SILT FENCE GEOTEXTILE SHALL MEET AASHTO M288-92 REQUIREMENTS.
 5. REMOVE & DISPOSE OF SEDIMENT WHEN ACCUMULATION IS 50% OF EXPOSED FENCE HEIGHT.
 6. 10' MAX. SPACING BETWEEN STAKES. SILT FENCES SHALL BE INSTALLED ALONG CONTOURS, NOT UP AND DOWN SLOPES, WITH 10' OVERLAP AT BREAKS.

5 TEMPORARY SILT FENCE

SCALE: NONE

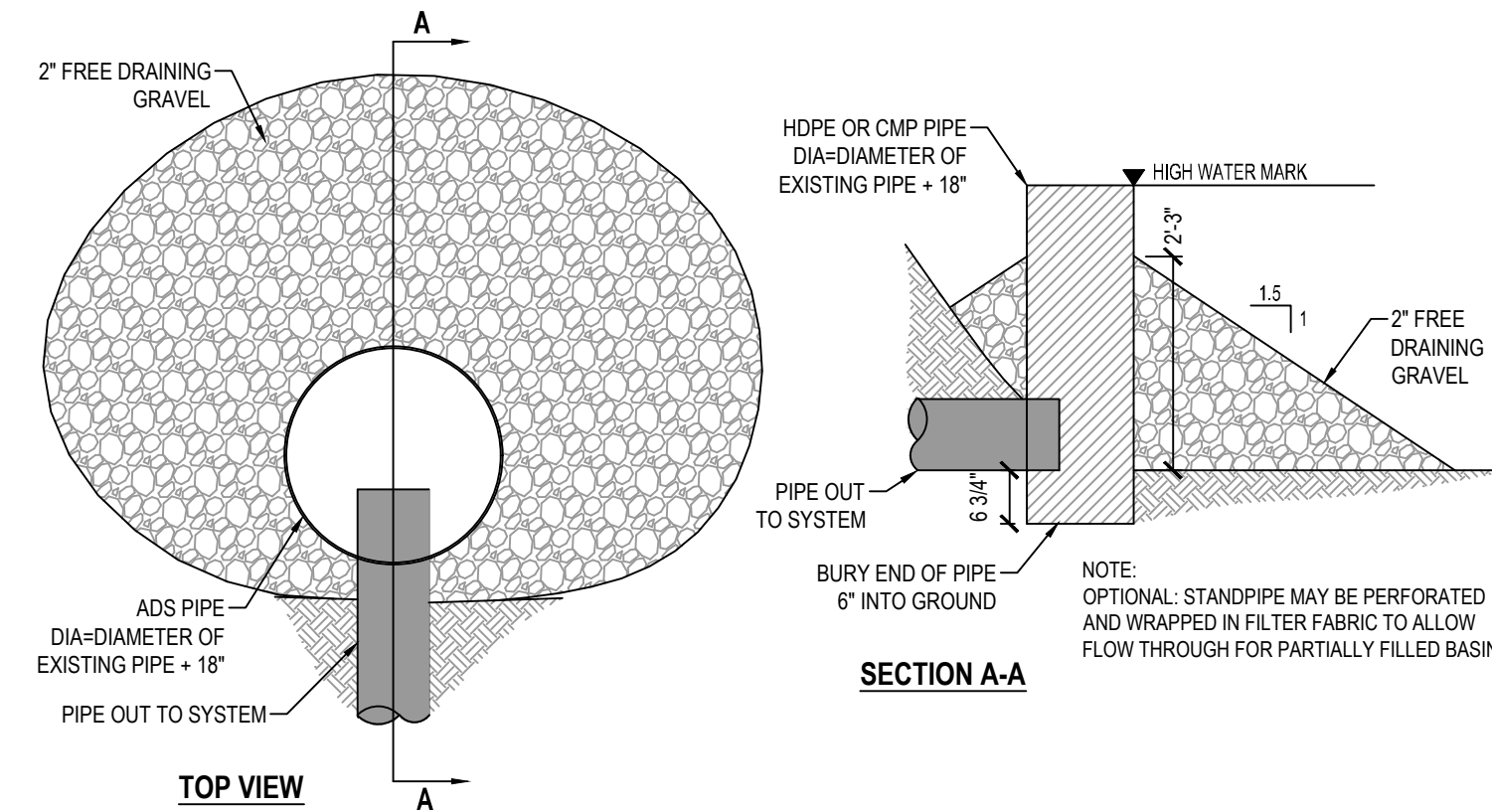

6 TEMPORARY BASIN OUTLET PROTECTION

SCALE: NONE

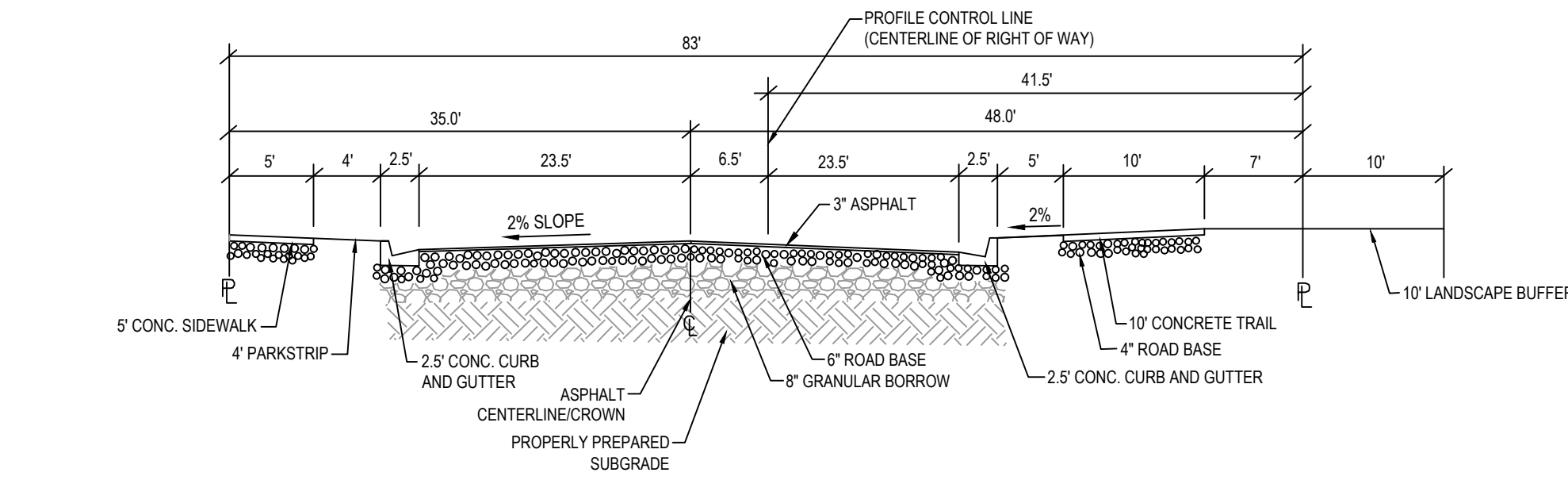

7 TYPICAL 83' STREET CROSS SECTION

SCALE: NONE

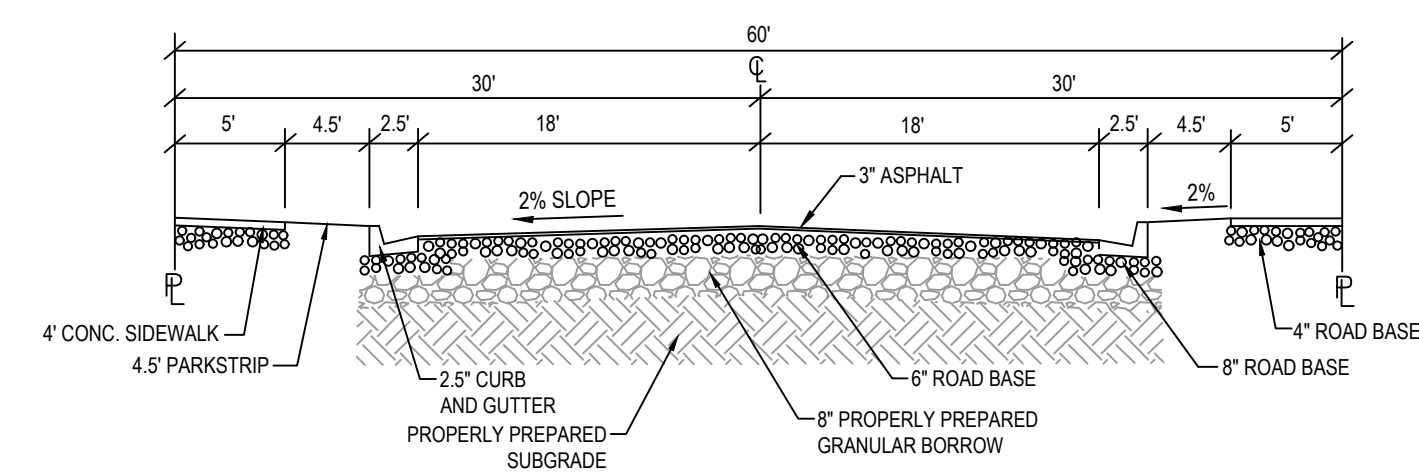

8 TYPICAL 60' STREET CROSS SECTION

SCALE: NONE

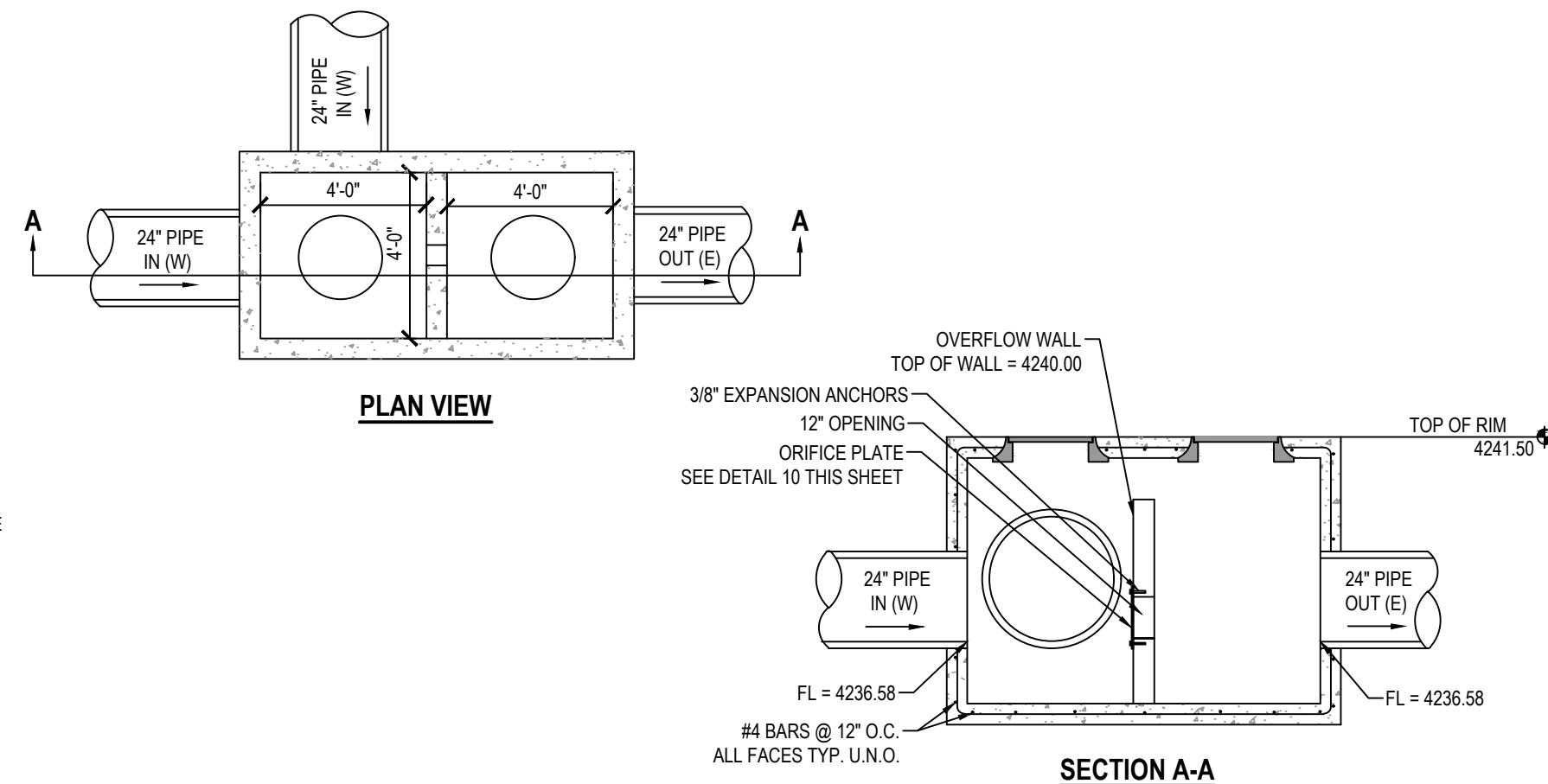

9 POND CONTROL STRUCTURE #215

SCALE: NONE

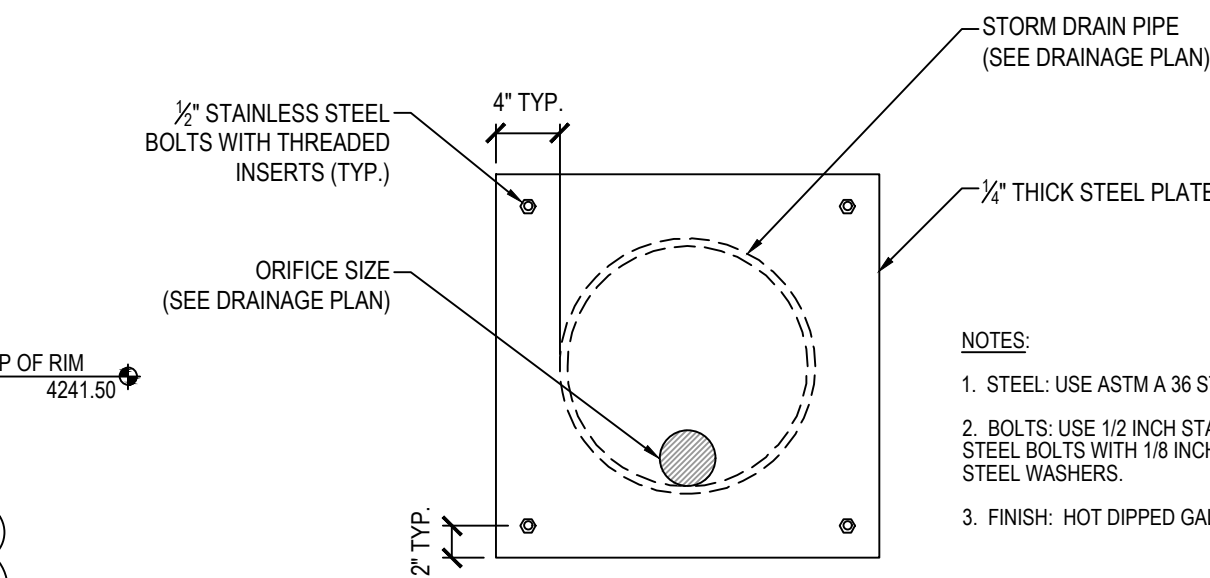

10 ORIFICE PLATE

SCALE: NONE

CONCRETE NOTES

1. ALL PAVING TO BE PLACED OVER PROPERLY PREPARED NATURAL SOILS AND/OR PROPERLY PREPARED EXISTING FILL SOILS AND PROPERLY COMPACTED STRUCTURAL FILL WHERE SPECIFIED.
2. ALL STRUCTURAL FILL TO BE PLACED AND COMPACTED PER THE PROJECT GEOTECHNICAL REPORT OR TO A MINIMUM OF 95% OF THE MAXIMUM DRY DENSITY AS DETERMINED BY THE AASHTO T-180 (D-1557) METHOD OF COMPACTION. LIFTS SHOULD BE PLACED PER GEOTECHNICAL RECOMMENDATIONS BUT SHOULD NOT EXCEED 8" IN LOOSE THICKNESS.
3. REMOVE SURFACE VEGETATION AND OTHER DELETERIOUS MATERIALS OVER THE ENTIRE SITE IN PREPARATION OF PROPOSED IMPROVEMENTS.

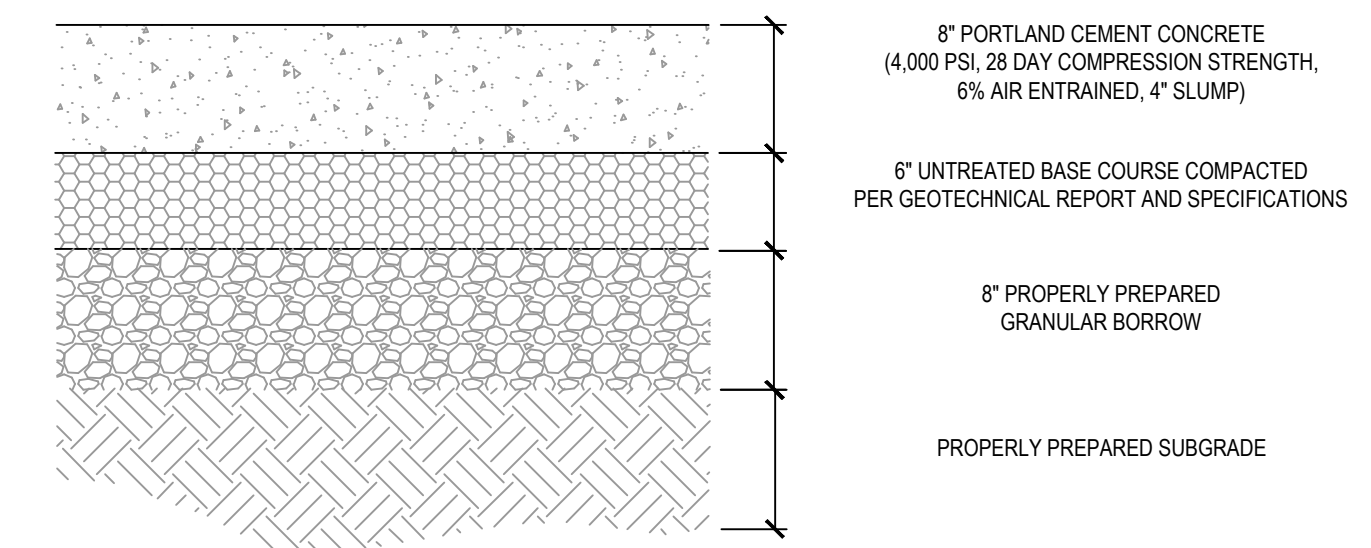

11 CONCRETE PAVEMENT SECTION

SCALE: NONE

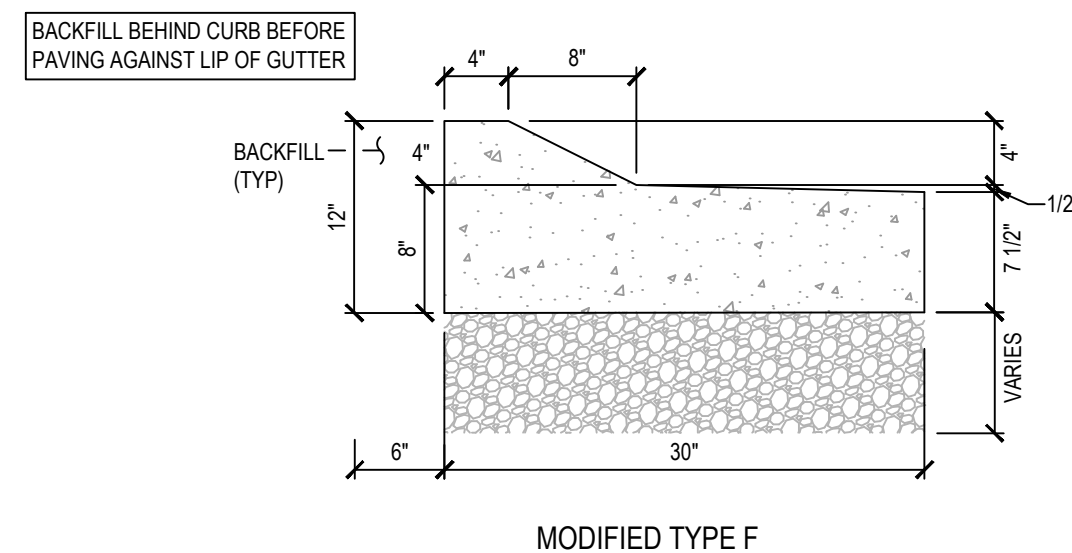

12 MODIFIED 30" REVERSE PAN TYPE 'F' CURB AND GUTTER

SCALE: NONE

1. GENERAL
 - A. Variance from specified dimensions and slopes must be acceptable to the ENGINEER. System configuration may be changed at ENGINEER'S discretion.
 - B. Additional requirements are specified in APWA Section 32 16 13.
2. PRODUCTS
 - A. Base Course: Untreated base course, APWA section 32 11 23. Do not use gravel as a base course without ENGINEER'S permission.
 - B. Expansion Joint Filler: 1/2-inch thick type F1 full depth, APWA Section 32 13 73.
 - C. Concrete: Class 4000, APWA Section 03 30 04. If necessary, provide concrete that achieves design strength in less than 7 days. Use caution; however, as concrete crazing (spider cracks) may develop if air temperature exceeds 90 degrees F.
 - D. Concrete Curing Agent: Clear membrane forming compound with fugitive dye (Type ID Class A), APWA Section 03 39 00.
3. EXECUTION
 - A. Base Course Placement: APWA Section 32 05 10. Thickness is 6-inches if flow-line grade is 0.5 percent (s=0.005) or greater. If slope is less, provide 8-inches. Maximum lift thickness before compaction is 8-inches when using riding equipment or 6-inches when using hand held equipment. Compaction is 95 percent or greater relative to a modified proctor density, APWA Section 31 23 25.
 - B. Concrete Placement: APWA Section 03 30 10.
 1. Install expansion joints vertical, full depth, with top of filler set flush with concrete surface. Install at the start or end of a street intersection curb return. Expansion joints are not required in concrete placement using slip-form construction.
 2. Install contraction joints vertical, 1/8-inch wide or 1/4 slab thickness if the slab is greater than 8-inches thick. Match joint location in adjacent Portland-cement concrete roadway pavement.
 3. Provide 1/2-inch radius edges. Apply a broom finish. Apply a curing agent.
 - C. Protection and Repair: Protect concrete from deicing chemicals during cure. Repair construction that does not drain. If necessary, fill flow-line with water to verify.



THE STANDARD IN ENGINEERING

LAYTON
919 North 400 West
Layton, UT 84041
Phone: 801.547.1100

SANDY
Phone: 801.255.0529

TOOELE
Phone: 435.843.3590

CEDAR CITY
Phone: 435.865.1453

RICHFIELD
Phone: 435.896.2983

WWW.ENSIGNENG.COM

FOR:
NILSON HOMES
1740 COMBE RD. SUITE 2
SOUTH OGDEN, UT 84403

CONTACT:
STEVE ANDERSON
PHONE: 801.392.8100

JDC PARKWAY

2800 WEST 2600 NORTH STREET

WEBER COUNTY, UTAH

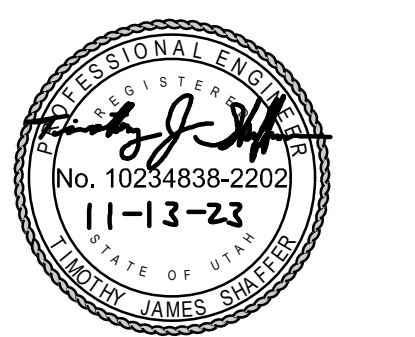

NO. DATE REVISION FOR REVIEW

DETAILS

PROJECT NUMBER 9872 PRINT DATE 2023-11-13

PROJECT MANAGER CP DESIGNED BY TS

C-500

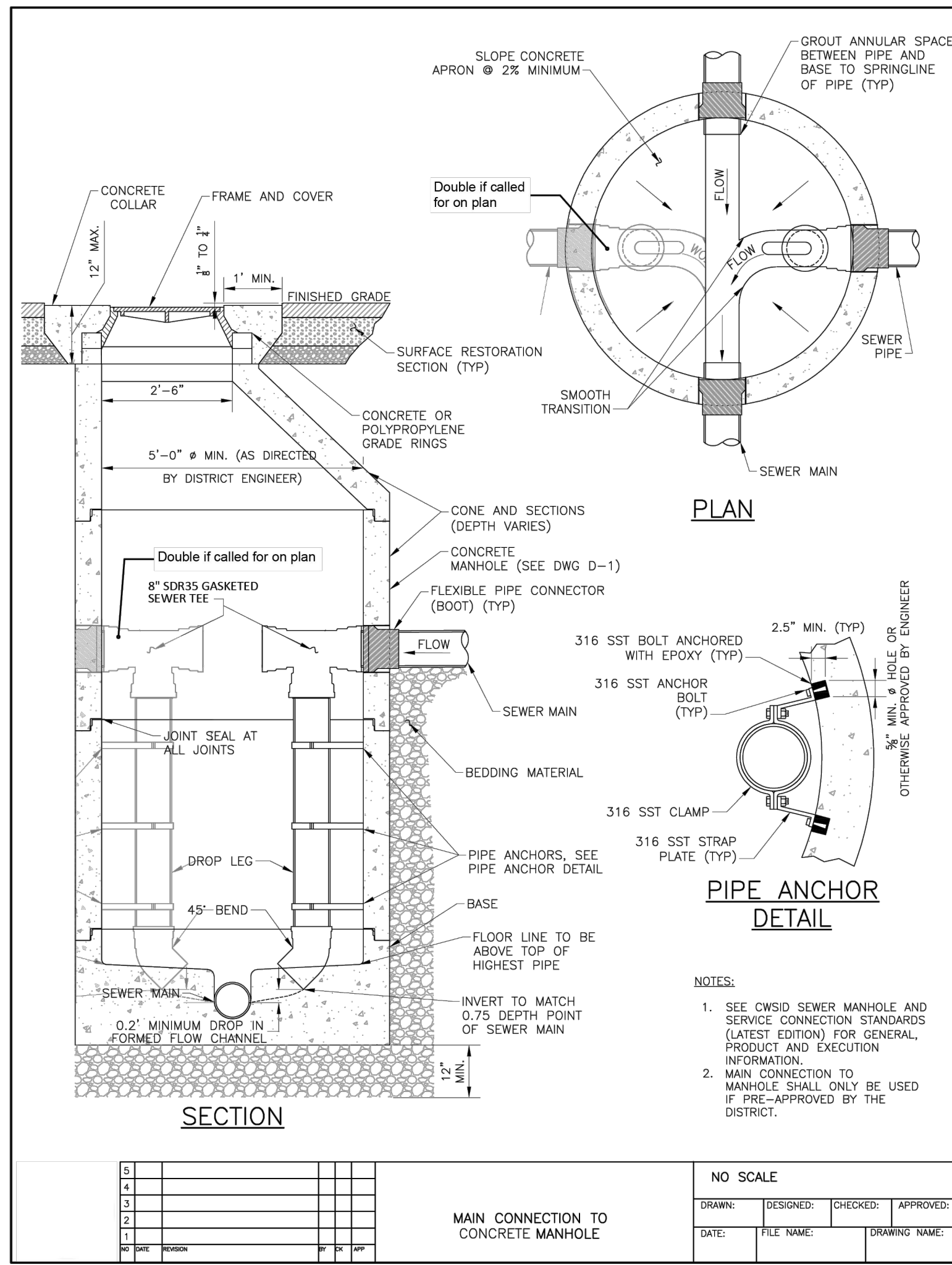

1 DROP MANHOLE SCALE: NONE



Technical Data

Series TF-1—Tideflex® Check Valve

Features & Benefits

- Ideal for manhole installations
- Lightweight, all-elastomer design
- Seals around entrapped solids
- Cost-effective, maintenance-free design

Materials of Construction

- Elastomers available in Pure Gum Rubber, Neoprene, Hypalon®, Chlorobutyl, Buna-N, EPDM, and Viton®

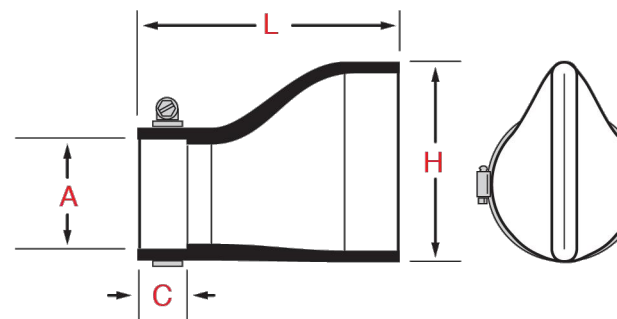
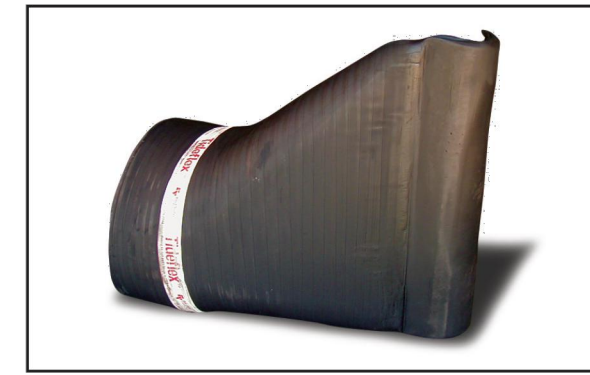

We are pleased to announce the introduction of the revolutionary TF-1 Check Valve. It functions and operates under the same simple principle of operation as the original TF-2 Tideflex®.

This design is ideal for existing manhole installations where the invert of the pipe is close to the floor of the vault. There are many check valves in interceptors, manholes, and vaults. These vaults are designed so that there would be a maximum gravity head; thus, the invert pipe is as close to the base as possible. The TF-1 allows installations in such applications.

The Tideflex® Technologies Series TF-1 Tideflex® Check Valve is designed for applications in manholes, where the bottom of the manhole is close to the invert of the pipe. The TF-1 configuration allows the valve to be properly installed without manhole modification, ensuring positive backflow prevention and a lifetime of maintenance-free performance.

Pipe O.D.	Length	Bill Height	Cuff Length
4	10	8	1 1/2
5	10	8	1 1/2
6	16	12	2
8	16	16	2
10	23	19	3
12	27	23	4
14	27	23	4
16	35	30	5
18	36	34	6
20	44	37	8
22	44	37	8
24	48	43	8
26	48	43	8
28	48	43	8
30	56	55	9
32	56	55	9
36	67	69	10
38	67	69	10
40	67	69	10
42	61	71	10
44	61	71	10
48	66	78	10
50	66	78	10
54	66	78	10
58	66	78	10
60	73	91	14
68	73	91	14
72	96	115	16

Numbers indicate maximum dimensions in inches.

Tideflex Technologies • 600 N. Bell Ave., Carnegie, PA 15106 USA • 412-279-0044 • Fax 412-279-7878 • www.tideflex.com

2 SERIES TF-1 TIDEFLEX CHECK VALVE SCALE: NONE



LAYTON
919 North 400 West
Layton, UT 84041
Phone: 801.547.1100

SANDY
Phone: 801.255.0529

TOOELE
Phone: 435.843.3590

CEDAR CITY
Phone: 435.865.1453

RICHFIELD
Phone: 435.896.2983

WWW.ENSGNENG.COM

FOR:
NILSON HOMES
1740 COMBE RD, SUITE 2
SOUTH OGDEN, UT 84403

CONTACT:
STEVE ANDERSON
PHONE: 801.392.8100

JDC PARKWAY
2800 WEST 2600 NORTH STREET
WEBER COUNTY, UTAH

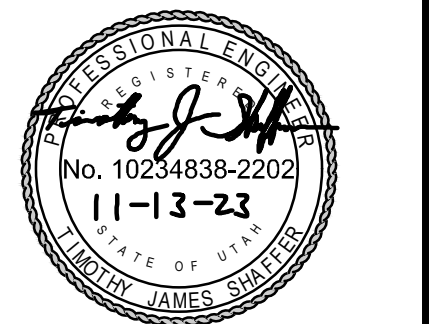

NO. DATE REVIEW FOR REVIEW

DETAILS

PROJECT NUMBER 9872 PRINT DATE 2023-11-13
PROJECT MANAGER CP DESIGNED BY TS

C-501