

OSPREY RANCH SUBDIVISION PHASE 1

LOCATED IN THE SOUTHEAST QUARTER OF SECTION 33 TOWNSHIP 7 NORTH RANGE 1 EAST AND THE NORTH HALF OF SECTIONS 3, AND 4 OF TOWNSHIP 6 NORTH, RANGE 1 EAST, SALT LAKE BASE AND MERIDIAN, WEBER COUNTY, UTAH, OCTOBER 2022

PHASE 1 BOUNDARY DESCRIPTION

A PART OF THE SOUTHEAST QUARTER OF SECTION 33, TOWNSHIP 7 NORTH, RANGE 1 EAST AND A PART OF THE NORTH HALF OF SECTIONS 3 AND 4 OF TOWNSHIP 6 NORTH, RANGE 1 EAST, OF THE SALT LAKE BASE AND MERIDIAN. BEGINNING AT A POINT ON THE EAST LINE OF SAID SOUTHEAST QUARTER BEING LOCATED NORTH 00°22'52" EAST 1323.89 FEET ALONG THE EAST LINE OF SAID SECTION 33 FROM THE SOUTHEAST CORNER OF SAID SECTION 33; RUNNING THENCE ALONG SAID EAST LINE SOUTH 00°22'52" WEST 672.71 FEET; THENCE NORTH 70° 00'53" WEST 107.12 FEET; THENCE SOUTH 10°11'47" WEST 178.55 FEET; THENCE SOUTH 05°08'51" EAST 152.07 FEET; THENCE SOUTH 00°17'39" WEST 360.00 FEET; THENCE SOUTH 89°19'35" EAST 1690.75 FEET TO THE WEST RIGHT-OF-WAY LINE OF STATE HIGHWAY 158; THENCE ALONG SAID WEST RIGHT-OF-WAY LINE THE FOLLOWING FOUR (4) COURSES: (1) SOUTH 26°32'40" EAST 650.08 FEET; (2) SOUTH 36°16'03" EAST 1586.42 FEET; (3) ALONG THE ARC OF A 1530.00 FOOT RADIUS CURVE TO THE RIGHT 383.09 FEET, HAVING A CENTRAL ANGLE OF 14°20'46", CHORD BEARS SOUTH 26°16'20" EAST 382.09 FEET; (4) SOUTH 19°05'57" EAST 476.77 FEET TO THE SOUTH LINE OF THE NORTHWEST QUARTER OF SAID SECTION 3; THENCE ALONG THE SOUTH LINE OF THE NORTHWEST QUARTER OF SAID SECTION 3 AND THE SOUTH LINE OF THE NORTHEAST QUARTER OF SAID SECTION 4 NORTH 90°00'00" WEST 4460.96 FEET; THENCE NORTH 00°15'53" EAST 1349.11 FEET; THENCE NORTH 45°00'00" EAST 160.42 FEET; THENCE NORTH 00°00'00" EAST 161.54 FEET; THENCE NORTH 53°49'45" EAST 44.12 FEET; THENCE ALONG THE ARC OF A 179.14 FOOT RADIUS CURVE TO THE RIGHT 47.39 FEET, HAVING A CENTRAL ANGLE OF 15°09'30", CHORD BEARS NORTH 21°33'54" WEST 47.26 FEET; THENCE NORTH 13°59'09" WEST 122.80 FEET; THENCE ALONG THE ARC OF A 122.00 FOOT RADIUS CURVE TO THE LEFT 118.61 FEET, HAVING A CENTRAL ANGLE OF 55°42'17", CHORD BEARS NORTH 41°50'18" WEST 114.00 FEET; THENCE NORTH 69°41'26" WEST 7.86 FEET; THENCE ALONG THE ARC OF A 328.00 FOOT RADIUS CURVE TO THE LEFT 16.92 FEET, HAVING A CENTRAL ANGLE OF 02°57'23", CHORD BEARS NORTH 71°10'07" WEST 16.92 FEET; THENCE NORTH 00°15'55" EAST 780.64 FEET ALONG THE EAST LINE OF LOT 2 OF SECTION 4 TOWNSHIP 6 NORTH, RANGE 1 EAST AND ITS PROJECTION; THENCE ALONG THE ARC OF A 120.68 FOOT RADIUS CURVE TO THE LEFT 63.53 FEET, HAVING A CENTRAL ANGLE OF 30°09'48", CHORD BEARS NORTH 78°44'38" WEST 62.80 FEET; THENCE ALONG THE ARC OF A 167.15 FOOT RADIUS CURVE TO THE RIGHT 101.44 FEET, HAVING A CENTRAL ANGLE OF 34°46'15", CHORD BEARS NORTH 73°52'07" WEST 99.89 FEET; THENCE NORTH 89°30'41" WEST 483.94 FEET; THENCE NORTH 00°11'58" EAST 1283.62 FEET; THENCE SOUTH 89°28'52" EAST 1965.83 FEET TO THE POINT OF BEGINNING, CONTAINING 283.839 ACRES.

AREA CALCULATIONS

TOTAL PROJECT AREA - 595.94 ACRES
 PHASE 1 AREA - 283.782 ACRES
 TOTAL COMMON AREA - 38.66 ACRES
 PHASE 1 COMMON AREA - 28.54 ACRES
 COMMUNITY PARK AREA - 2.05 ACRES

SURVEYOR'S CERTIFICATE

I, KLINT H. WHITNEY, DO HEREBY CERTIFY THAT I AM A LICENSED PROFESSIONAL LAND SURVEYOR IN THE STATE OF UTAH AND THAT I HOLD CERTIFICATE NO. 8227228 IN ACCORDANCE WITH TITLE 58, CHAPTER 22, OF THE PROFESSIONAL ENGINEERS AND LAND SURVEYORS ACT; I FURTHER CERTIFY THAT BY AUTHORITY OF THE OWNERS I HAVE COMPLETED A SURVEY OF THE PROPERTY AS SHOWN AND DESCRIBED ON THIS PLAT, AND HAVE SUBDIVIDED SAID PROPERTY INTO LOTS AND STREETS, TOGETHER WITH EASEMENTS, HEREAFTER TO BE KNOWN AS OSPREY RANCH PHASE 1 IN ACCORDANCE WITH SECTION 17-23-17 AND HAVE VERIFIED ALL MEASUREMENTS, THAT THE REFERENCE MONUMENTS SHOWN HEREON ARE LOCATED AS INDICATED AND ARE SUFFICIENT TO RETRACE OR REESTABLISH THIS SURVEY; THAT ALL LOTS MEET THE REQUIREMENTS OF THE LAND USE CODE; AND THAT THE INFORMATION SHOWN HEREIN IS SUFFICIENT TO ACCURATELY ESTABLISH THE LATERAL BOUNDARIES OF THE HEREIN DESCRIBED TRACT OF REAL PROPERTY.

SIGNED THIS _____ DAY OF _____, 2022.



KLINT H. WHITNEY, PLS NO. 8227228

OWNER'S DEDICATION

I THE UNDERSIGNED OWNER OF THE HERON DESCRIBED TRACT OF LAND, HEREBY SET APART AND SUBDIVIDE THE SAME INTO LOTS, PARCELS AND STREETS AS SHOWN ON THIS PLAT AND NAME SAID TRACT:

OSPREY RANCH PHASE 1

AND HEREBY DEDICATE AND CONVEY TO WEBER COUNTY, UTAH ALL THOSE PARTS OR PORTIONS OF SAID TRACT OF LAND DESIGNATED AS STREETS, THE SAME TO BE USED AS PUBLIC THOROUGHFARES FOREVER, AND ALSO DOES HEREBY GRANT AND CONVEY TO THE OSPREY RANCH OWNERS ASSOCIATION, INC. (AND ITS SUCCESSORS AND ASSIGNS) WHOSE MEMBERSHIP CONSISTS OF THE MEMBERS/OWNERS OF SAID ASSOCIATION, THEIR GRANTEEES, SUCCESSORS AND/OR ASSIGNS ALL THOSE PART OR PORTIONS OF SAID TRACT OF LAND DESIGNATED AND DEPICTED ON SAID PLAT AS COMMON AREAS, WHICH ARE TO BE USED FOR PRIVATE RECREATIONAL AND OPEN SPACE PURPOSES BY AND FOR THE BENEFIT OF EACH ASSOCIATION MEMBER/OWNER IN COMMON WITH ALL OTHERS IN THE SUBDIVISION, WITH SUCH COMMON AREAS TO BE MAINTAINED BY SAID ASSOCIATION, AND DOES ALSO HEREBY GRANT AND CONVEY TO SAID ASSOCIATION ALL THOSE PARTS OR PORTIONS OF SAID TRACT OF LAND DESIGNATED AND DEPICTED ON SAID PLAT AS TRAILS AND TRAIL EASEMENTS, INCLUDING ANY SUCH TRAILS OR TRAIL EASEMENTS LOCATED ON ANY COMMON AREAS OR ON ANY INDIVIDUAL LOTS, WHICH TRAILS AND TRAIL EASEMENTS ARE TO BE USED FOR PRIVATE RECREATIONAL PURPOSES BY AND FOR THE BENEFIT OF THE ASSOCIATION'S MEMBERS/OWNERS AND IN COMMON WITH ALL OTHERS IN THE SUBDIVISION, WITH SUCH TRAILS AND TRAIL EASEMENTS TO BE MAINTAINED BY SAID ASSOCIATION, AND ALSO GRANT AND DEDICATE A PERPETUAL EASEMENT OVER, UPON AND UNDER THE LANDS DESIGNATED ON THE PLAT AS COMMON AREA, THE SAME TO BE USED FOR THE INSTALLATION, MAINTENANCE AND OPERATION OF PUBLIC UTILITY SERVICE LINES THAT SERVE LOTS WITHIN THE SUBDIVISION AND FOR STORM DRAINAGE FACILITIES OR THE PERPETUAL PRESERVATION OF WATER DRAINAGE CHANNELS IN THEIR NATURAL STATE, WHICHEVER IS APPLICABLE, AS MAY BE AUTHORIZED BY THE GOVERNING AUTHORITY, AND ALSO GRANTS AND DEDICATES TO WEBER COUNTY A PERPETUAL OPEN SPACE RIGHT AND EASEMENT ON AND OVER THE COMMON AREAS TO GUARANTEE TO WEBER COUNTY THAT SUCH COMMON AREAS REMAIN OPEN AND UNDEVELOPED EXCEPT FOR APPROVED RECREATIONAL, PARKING AND OPEN SPACE PURPOSES, AND ALSO GRANTS AND DEDICATES A PERPETUAL RIGHT AND EASEMENT OVER, UPON AND UNDER THE LANDS DESIGNATED ON THE PLAT AS PUBLIC UTILITY, STORM WATER DETENTION PONDS AND DRAINAGE EASEMENTS, TO BE USED FOR THE INSTALLATION, MAINTENANCE AND OPERATION OF PUBLIC UTILITY SERVICE LINES THAT SERVE LOTS WITHIN THE SUBDIVISION AND FOR STORM DRAINAGE FACILITIES OR THE PERPETUAL PRESERVATION OF WATER DRAINAGE CHANNELS IN THEIR NATURAL STATE, WHICHEVER IS APPLICABLE, AS MAY BE AUTHORIZED BY THE GOVERNING AUTHORITY, WITH NO BUILDINGS OR STRUCTURES BEING ERRECTED WITHIN SUCH EASEMENTS AND ALSO GRANT DEDICATE AND CONVEY LAND DESIGNATED AS SEWER EASEMENT TO WOLF CREEK WATER AND SEWER IMPROVEMENT DISTRICT FOR THE PURPOSE OF INSTALLING, MAINTAINING AND REPAIRING SANITARY SEWER LINES AND STRUCTURES AND ALSO GRANT DEDICATE AND CONVEY TO WEBER COUNTY LAND DESIGNATED AS DRAINAGE EASEMENT TO WEBER COUNTY FOR DRAINAGE AND STORM DRAIN PURPOSES.

SIGNED THIS ____ DAY OF _____, 2022.

OSPREY RANCH, LLC

BY: JOHN LEWIS, MANAGING MEMBER

THE CARL LORENTZEN LIVING TRUST, DATED SEPTEMBER 12, 2003, AMENDED AND RESTATED OCTOBER 20, 2016

BY: CARL LORENTZEN, TRUSTEE

ACKNOWLEDGEMENT

STATE OF UTAH)
)
 COUNTY OF WEBER)

On this _____ day of _____, 2022, personally appeared before me JOHN LEWIS, whose identity is personally known to me (or proven on the basis of satisfactory evidence) and who by me duly sworn/affirmed, did say that he/she is the MANAGING MEMBER OF OSPREY RANCH, LLC, and that said document was signed by him/her in behalf of said Corporation by Authority of its Bylaws, or (Resolution of its Board of Directors), and said JOHN LEWIS acknowledged to me that said Corporation executed the same.

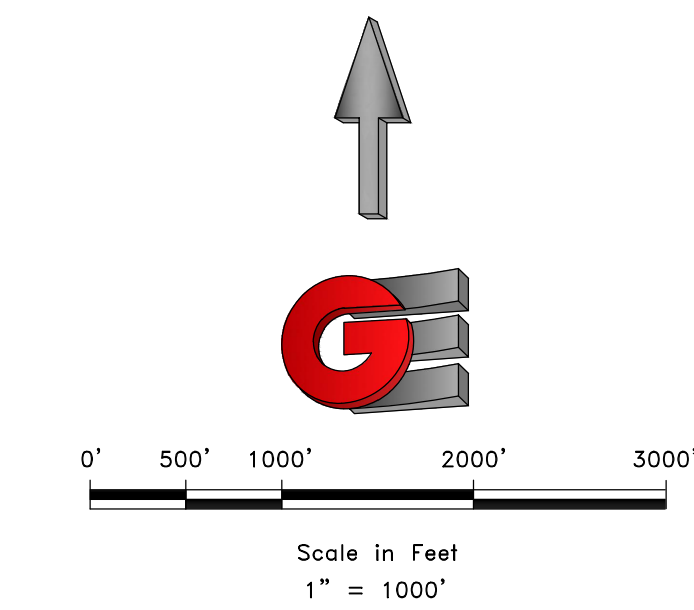

LEGEND

- WEBER COUNTY MONUMENT AS NOTED
-
-
-
-
-
-
-
-

CURVE TABLE

CURVE #	LENGTH	RADIUS	DELTA	CHORD BEARING	CHORD LENGTH
C1	47.39	179.14	15°09'30"	N21° 33' 54"W	47.26
C2	118.61	122.00	55°42'17"	N41° 50' 18"W	114.00
C3	16.92	328.00	2°57'23"	N71° 10' 07"W	16.92
C4	63.53	120.68	30°09'48"	N78° 44' 38"W	62.80
C5	101.44	167.15	34°46'15"	N73° 52' 07"W	99.89
C6	383.09	1530.00	14°20'46"	S26° 16' 20"E	382.09

NOTES

- ZONE FV-3 CURRENT YARD SETBACKS: FRONT 30', SIDE 20' - SIDE FACING STREET ON CORNER 30', REAR MAIN BUILDING 30' - ACCESSORY BUILDING 10'.
- SUBJECT PROPERTY FALLS WITHIN FEMA FLOOD ZONE "X" - AREAS DETERMINED TO BE OUTSIDE THE 0.2% ANNUAL CHANCE FLOODPLAIN, PER FEMA MAP NO. 49057C0237F WITH AN EFFECTIVE DATE OF JUNE 2, 2015.
- A NATURAL HAZARD NOTICE SHALL BE RECORDED WITH THE PLAT, AND A NOTE ON THE FINAL PLAT SHALL BE REQUIRED WHICH STATES THAT THE PARCEL IS LOCATED WITHIN A NATURAL HAZARD STUDY AREA.
- *A LOT WITH A DELINEATED "BUILDABLE AREA" SHALL ONLY ALLOW BUILDINGS WITHIN THE DESIGNATED BUILDABLE AREA.*
- EACH LOT SHALL BE RESPONSIBLE TO PROVIDE INDIVIDUAL LOT DETENTION. CALCULATIONS FOR DETAING STORM WATER SHALL BE INCLUDED AS PART OF BUILDING PERMIT.

ACKNOWLEDGEMENT

STATE OF UTAH)
)
 COUNTY OF WEBER)

On this _____ day of _____, 2022, personally appeared before me CARL LORENTZEN, whose identity is personally known to me (or proven on the basis of satisfactory evidence) and who by me duly sworn/affirmed, did say that he/she is the TRUSTEE OF THE CARL LORENTZEN LIVING TRUST, DATED SEPTEMBER 12, 2003, AMENDED AND RESTATED OCTOBER 20, 2016, and that said document was signed by him/her in behalf of said Trust by Authority of its Bylaws, or (Resolution of its Board of Directors), and said CARL LORENTZEN acknowledged to me that said Trust executed the same.

STAMP

NOTARY PUBLIC

NARRATIVE

THE PURPOSE OF THIS SURVEY WAS TO CREATE A SUBDIVISION ON THE PROPERTY AS SHOWN AND DESCRIBED HEREON. THE SURVEY WAS ORDERED BY OSPREY RANCH LLC. THE CONTROL USED TO ESTABLISH THE BOUNDARY WAS THE EXISTING WEBER COUNTY SURVEY MONUMENTATION AS SHOWN AND NOTED HEREON. THE BASIS OF BEARING IS THE EAST LINE OF SECTION 33, TOWNSHIP 7 NORTH, RANGE 1 EAST, OF THE SALT LAKE BASE AND MERIDIAN WHICH BEARS NORTH 00°22'52" EAST WEBER COUNTY, UTAH NORTH, NAD 83 STATE PLANE GRID BEARING, THE RIGHT-OF-WAY OF HIGHWAY 158 WAS ESTABLISHED BY DRAWINGS RECEIVED FROM U.D.O.T. REGION 1 FEDERAL AID PROJECT H99-0158(116)0 PIN:5522 DATED 4/30/2012. WARRANTY DEEDS RECORDED AS ENTRY NUMBERS 3143604, 3145237, 3145286 AND DEEDS OF ADJOINING PROPERTY OWNERS, RECORD OF SURVEY NUMBERS 1002, 293, 4608, 5102, 3584, AND THE DEDICATED PLATS OF BIG SKY ESTATES NO. 1, BIG SKY ESTATES NO. 2, BLAKE HOLLEY SUBDIVISION, EDEN ESTATES SUBDIVISION WERE ALSO USED TO DETERMINE BOUNDARY LOCATION.

STAMP

NOTARY PUBLIC

DEVELOPER:
OSPREY RANCH LLC
JOHN LEWIS
3718 NORTH WOLF CREEK DRIVE
EDEN, UTAH, 84310
801-430-1507

S1

7

GARDNER ENGINEERING
CIVIL • LAND PLANNING
MUNICIPAL • WIND SURVEYING
5150 SOUTH 875 EAST OGDEN, UT
OFFICE: 801.476.0202 FAX: 801.476.0066

COUNTY RECORDER

ENTRY NO. _____ FEE PAID _____

FILED FOR AND RECORDED _____

AT _____ IN BOOK _____ OF OFFICIAL _____

RECORDS, PAGE _____ RECORDED _____

FOR _____

COUNTY RECORDER

BY: _____

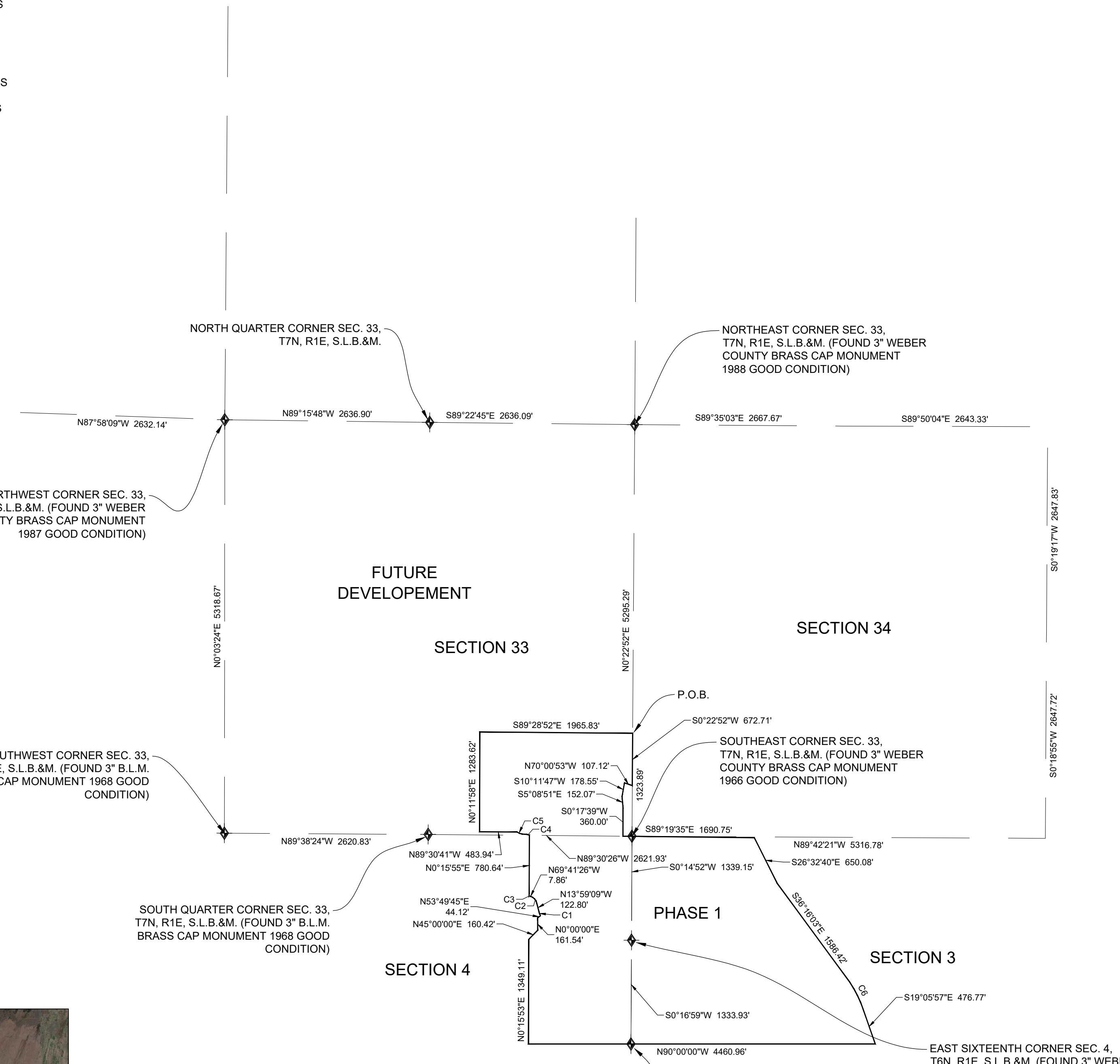

NORDIC MOUNTAIN WATER INC.

APPROVED BY NORDIC MOUNTAIN WATER INC. ON

THE _____ DAY OF _____, 20____

PRESIDENT: BILL GREEN

WOLF CREEK WATER AND SEWER IMPROVEMENT DISTRICT

APPROVED BY WOLF CREEK WATER AND SEWER IMPROVEMENT DISTRICT ON

THE _____ DAY OF _____, 20____

MANAGER: ROB THOMAS

WEBER COUNTY SURVEYOR

I HEREBY CERTIFY THAT THE WEBER COUNTY SURVEYOR'S OFFICE HAS REVIEWED THIS PLAT AND ALL CONDITIONS FOR APPROVAL BY THIS OFFICE HAVE BEEN SATISFIED. THE APPROVAL OF THIS PLAT BY THE WEBER COUNTY SURVEYOR DOES NOT RELIEVE THE LICENSED LAND SURVEYOR WHO EXECUTED THIS PLAT FROM THE RESPONSIBILITIES AND/OR LIABILITIES ASSOCIATED THEREWITH.

SIGNED THIS _____ DAY OF _____, 2022.

COUNTY SURVEYOR

RECORD OF SURVEY: _____

WEBER COUNTY ATTORNEY

I HAVE EXAMINED THE FINANCIAL GUARANTEE AND OTHER DOCUMENTS ASSOCIATED WITH THIS SUBDIVISION PLAT AND IN MY OPINION THEY CONFORM WITH THE COUNTY ORDINANCE APPLICABLE THERETO AND NOW IN FORCE AND EFFECT.

SIGNED THIS _____ DAY OF _____, 2022.

COUNTY ATTORNEY

WEBER COUNTY ENGINEER

I HEREBY CERTIFY THAT THE REQUIRED PUBLIC IMPROVEMENT STANDARDS AND DRAWINGS FOR THIS SUBDIVISION CONFORM WITH COUNTY STANDARDS AND THE AMOUNT OF THE FINANCIAL GUARANTEE IS SUFFICIENT FOR THE INSTALLATION OF THESE IMPROVEMENTS.

SIGNED THIS _____ DAY OF _____, 2022.

COUNTY ENGINEER

WEBER COUNTY COMMISSION ACCEPTANCE

THIS IS TO CERTIFY THAT THIS SUBDIVISION PLAT, THE DEDICATION OF STREETS AND OTHER PUBLIC WAYS AND FINANCIAL GUARANTEE OF PUBLIC IMPROVEMENTS ASSOCIATED WITH THIS SUBDIVISION THEREON ARE HEREBY APPROVED AND ACCEPTED BY THE COMMISSIONERS OF WEBER COUNTY, UTAH.

SIGNED THIS _____ DAY OF _____, 2022.

CHAIRMAN, WEBER COUNTY COMMISSION

ATTEST: _____ NAME/TITLE

WEBER COUNTY PLANNING COMMISSION APPROVAL

THIS IS TO CERTIFY THAT THIS SUBDIVISION WAS DULY APPROVED BY THE WEBER COUNTY PLANNING COMMISSION.

SIGNED THIS _____ DAY OF _____, 2022.

CHAIRMAN, WEBER COUNTY PLANNING COMMISSION

WEBER - MORGAN HEALTH DEPARTMENT

I DO HEREBY CERTIFY THAT THE SOILS, PERCOLATION RATES, AND SITE CONDITION FOR THIS SUBDIVISION HAVE BEEN INVESTIGATED BY THIS OFFICE AND ARE APPROVED FOR ON-SITE WASTEWATER DISPOSAL SYSTEMS.

SIGNED THIS _____ DAY OF _____, 2022.

DIRECTOR WEBER-MORGAN HEALTH DEPT.

R:\1201 - LEWIS HOMES\05 - OSPREY RANCH\SUBDIVISION\OSPREY RANCH PHASE 1 PLAT REVISED LOTS BLOCKING

OSPREY RANCH SUBDIVISION PHASE 1

LOCATED IN THE SOUTHEAST QUARTER OF SECTION 33 TOWNSHIP 7 NORTH RANGE 1 EAST AND THE NORTH HALF OF SECTIONS 3, AND 4 OF TOWNSHIP 6 NORTH, RANGE 1 EAST, SALT LAKE BASE AND MERIDIAN, WEBER COUNTY, UTAH, OCTOBER 2022

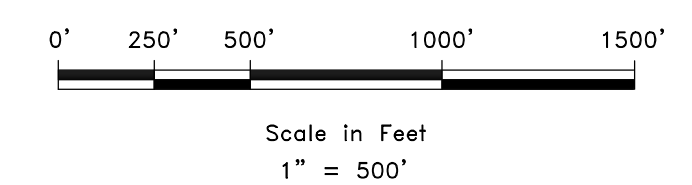
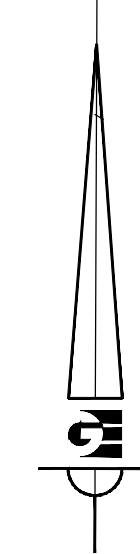

- LEGEND**
- ◆ WEBER COUNTY MONUMENT AS NOTED
 - SET 24" REBAR AND CAP MARKED GARDNER ENGINEERING
 - SUBDIVISION BOUNDARY
 - LOT LINE
 - - - ADJACENT PARCEL
 - - - SECTION LINE
 - - - EASEMENT
 - x - EXISTING FENCE LINE
 - - - DRAINAGE EASEMENT

R11201 - LEWIS HOMES2105 - OSPREY RANCH SURVEY FOR OSPREY RANCH PHASE 1 PLAT REVISED LOTS BLOCKING

DEVELOPER: OSPREY RANCH LLC JOHN LEWIS 3718 NORTH WOLF CREEK DRIVE EDEN, UTAH, 84310 801-430-1507	S2 7	COUNTY RECORDER ENTRY NO. _____ FEE PAID _____ FILED FOR AND RECORDED _____ AT _____ IN BOOK _____ OF OFFICIAL RECORDS, PAGE _____ RECORDED FOR _____ COUNTY RECORDER BY: _____
	<p>GARDNER ENGINEERING CIVIL • LAND PLANNING MUNICIPAL • LAND SURVEYING 5150 SOUTH 375 EAST OGDEN, UT OFFICE: 801-476-0202 FAX: 801-476-0666</p>	

OSPREY RANCH SUBDIVISION PHASE 1

LOCATED IN THE SOUTHEAST QUARTER OF SECTION 33 TOWNSHIP 7 NORTH RANGE 1 EAST AND THE NORTH HALF OF SECTIONS 3, AND 4 OF TOWNSHIP 6 NORTH, RANGE 1 EAST, SALT LAKE BASE AND MERIDIAN, WEBER COUNTY, UTAH, OCTOBER 2022

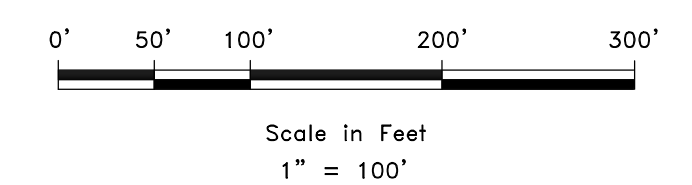
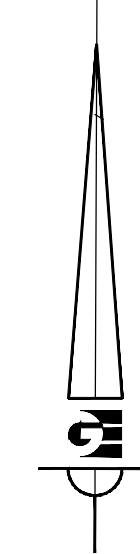
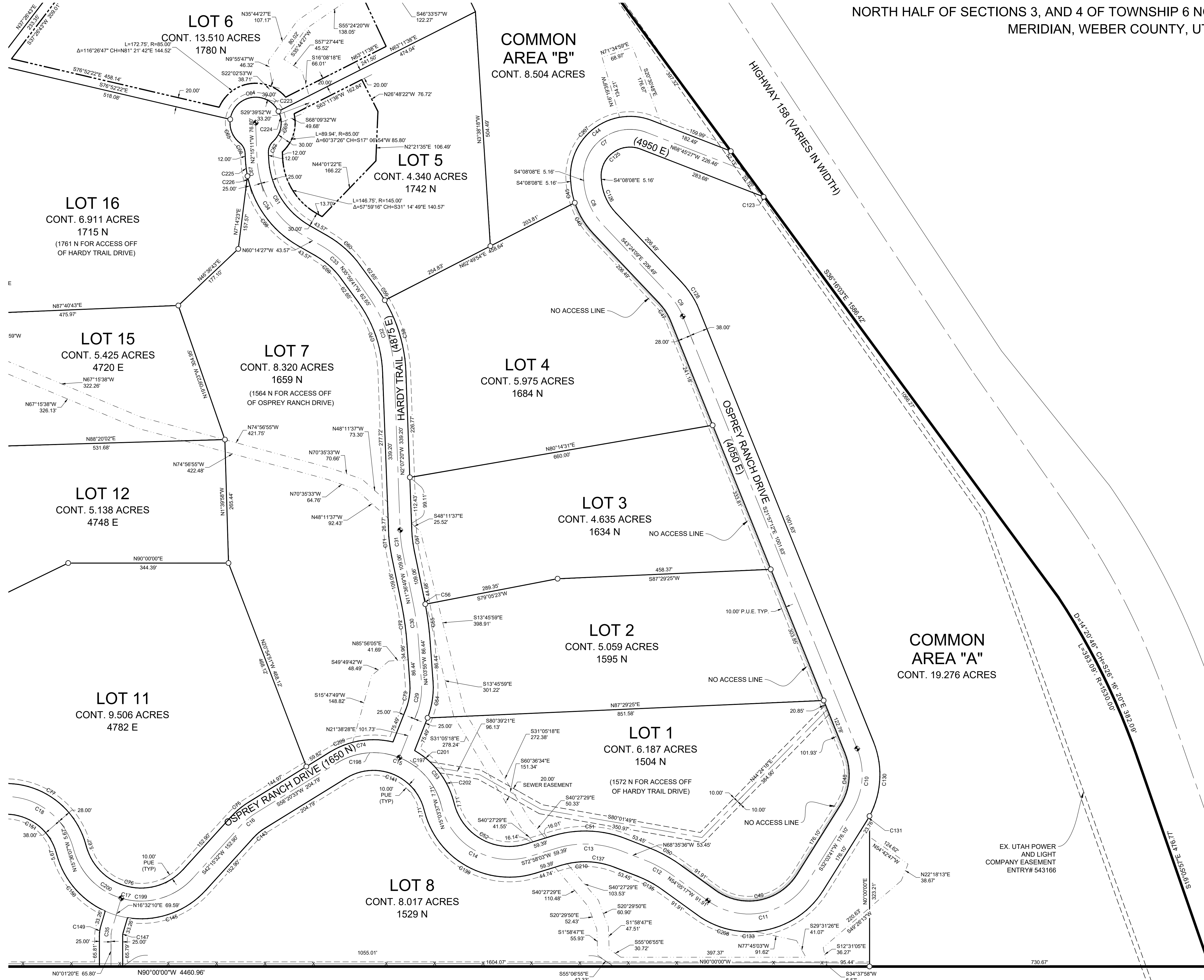

LEGEND

- ◆ WEBER COUNTY MONUMENT AS NOTED
- SET 24" REBAR AND CAP MARKED GARDNER ENGINEERING
- SUBDIVISION BOUNDARY
- - - LOT LINE
- - - ADJACENT PARCEL
- - - SECTION LINE
- - - EASEMENT
- - - EXISTING FENCE LINE
- - - BUILDABLE AREA SEE NOTE 4
- - - DRAINAGE EASEMENT
- ||||| NO ACCESS LINE

R12201 - LEWIS HOMES2105 - OSPREY RANCH SURVEY FOR OSPREY RANCH PHASE 1 PLAT REVISED LOTS BLOCKING

DEVELOPER: OSPREY RANCH LLC JOHN LEWIS 3718 NORTH WOLF CREEK DRIVE EDEN, UTAH, 84310 801-430-1507	S3 7	COUNTY RECORDER ENTRY NO. _____ FEE PAID _____ FILED FOR AND RECORDED _____ AT _____ IN BOOK _____ OF OFFICIAL _____ RECORDS, PAGE _____ RECORDED _____ FOR _____ COUNTY RECORDER _____ BY: _____
		CIVIL • LAND PLANNING MUNICIPAL • LAND SURVEYING 5150 SOUTH 375 EAST OGDEN, UT OFFICE: 801.476.0202 FAX: 801.476.0666

OSPREY RANCH SUBDIVISION PHASE 1

LOCATED IN THE SOUTHEAST QUARTER OF SECTION 33 TOWNSHIP 7 NORTH RANGE 1 EAST AND THE NORTH HALF OF SECTIONS 3, AND 4 OF TOWNSHIP 6 NORTH, RANGE 1 EAST, SALT LAKE BASE AND

MERIDIAN, WEBER COUNTY, UTAH, OCTOBER 2022

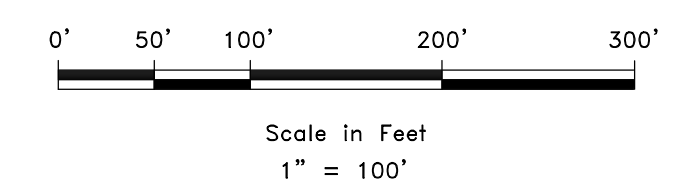
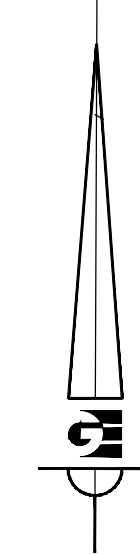
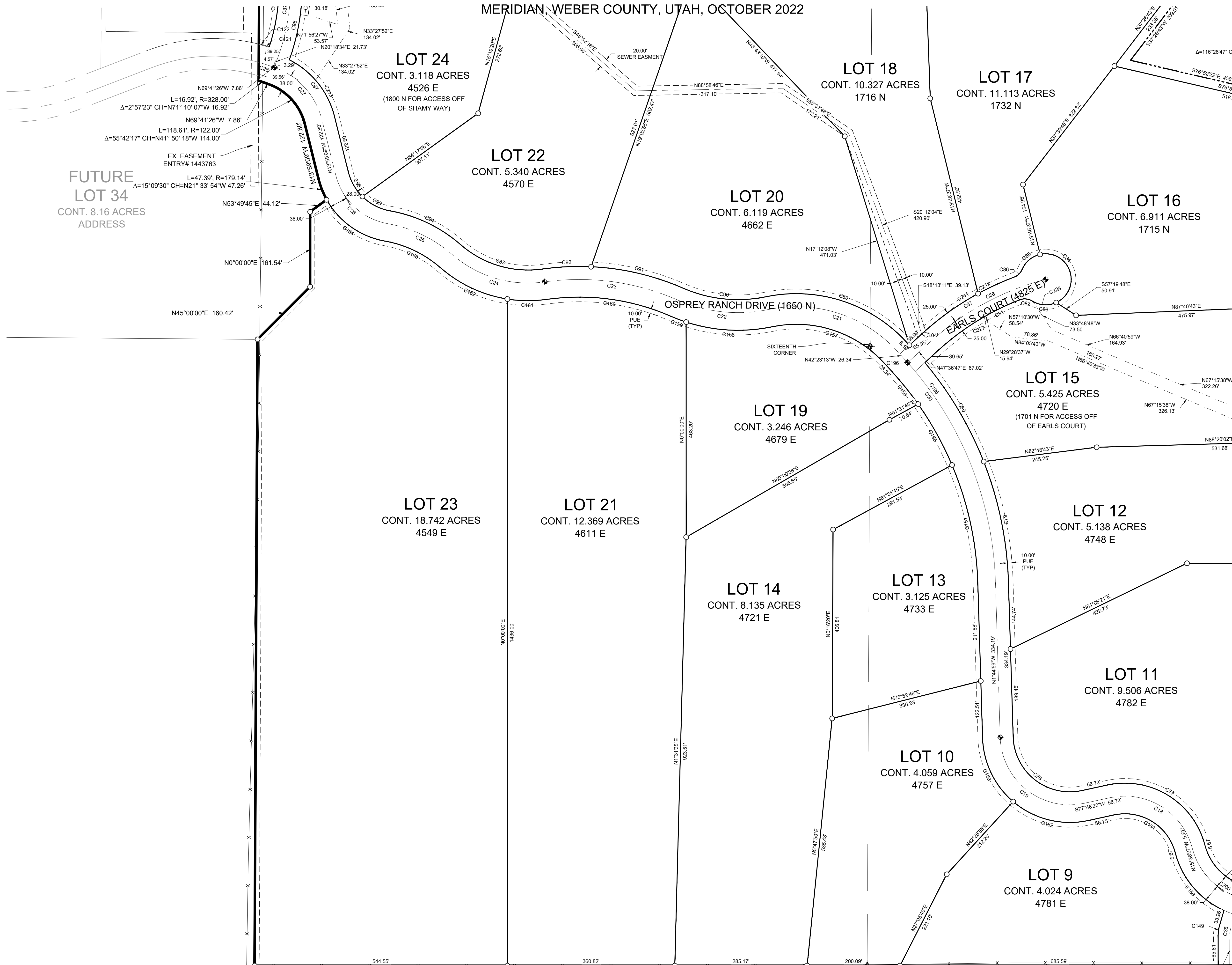

LEGEND

- WEBER COUNTY MONUMENT AS NOTED
- SET 24" REBAR AND CAP MARKED GARDNER ENGINEERING
- SUBDIVISION BOUNDARY
- LOT LINE
- ADJACENT PARCEL
- SECTION LINE
- EASEMENT
- EXISTING FENCE LINE
- BUILDABLE AREA SEE NOTE 4
- DRAINAGE EASEMENT

R11201 - LEWIS HOMES 02.05 - OSPREY RANCH SURVEY FOR OSPREY RANCH PHASE 1 PLAT REVISED LOTS BLOCKING

EAST QUARTER CORNER SEC. 4, T6N, R1E, S1B.M. (FOUND 3" WEBER COUNTY GRASS CAP MONUMENT 1967 GOOD CONDITION)

DEVELOPER:
OSPREY RANCH LLC
JOHN LEWIS
3718 NORTH WOLF CREEK DRIVE
EDEN, UTAH, 84310
801-430-1507

S4
7

COUNTY RECORDER
ENTRY NO. _____ FEE PAID _____
FILED FOR AND RECORDED _____
AT _____ IN BOOK _____ OF OFFICIAL _____
RECORDS, PAGE _____ RECORDED _____
FOR _____
WEBER COUNTY RECORDER
BY: _____

GARDNER ENGINEERING
CITY OF EDEN, UTAH
5150 SOUTH 375 EAST EDEN, UT
OFFICE: 801.476.0202 FAX: 801.476.0066

OSPREY RANCH SUBDIVISION PHASE 1
 LOCATED IN THE SOUTHEAST QUARTER OF SECTION 33 TOWNSHIP 7 NORTH RANGE 1 EAST AND THE
 NORTH HALF OF SECTIONS 3, AND 4 OF TOWNSHIP 6 NORTH, RANGE 1 EAST, SALT LAKE BASE AND
 MERIDIAN, WEBER COUNTY, UTAH, OCTOBER 2022

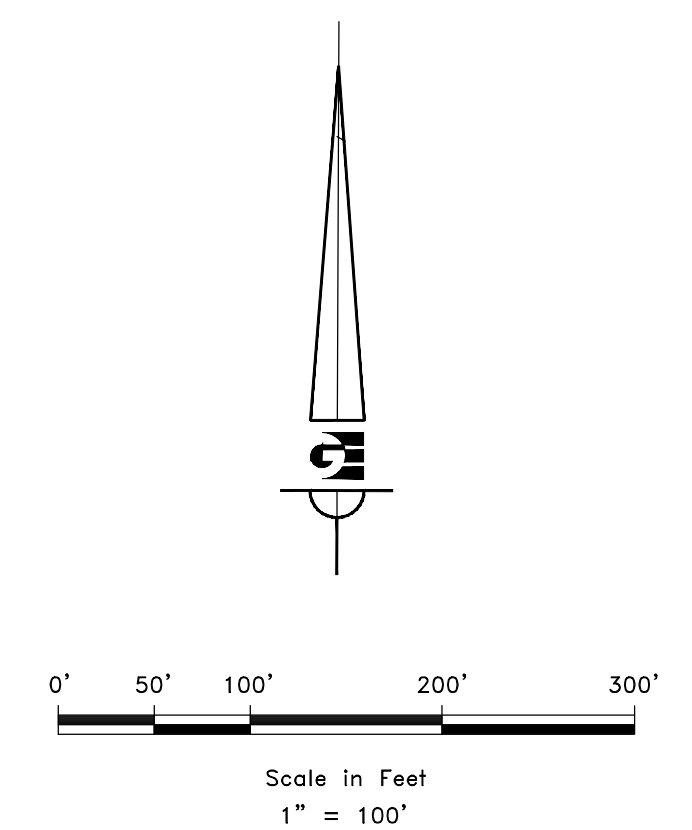
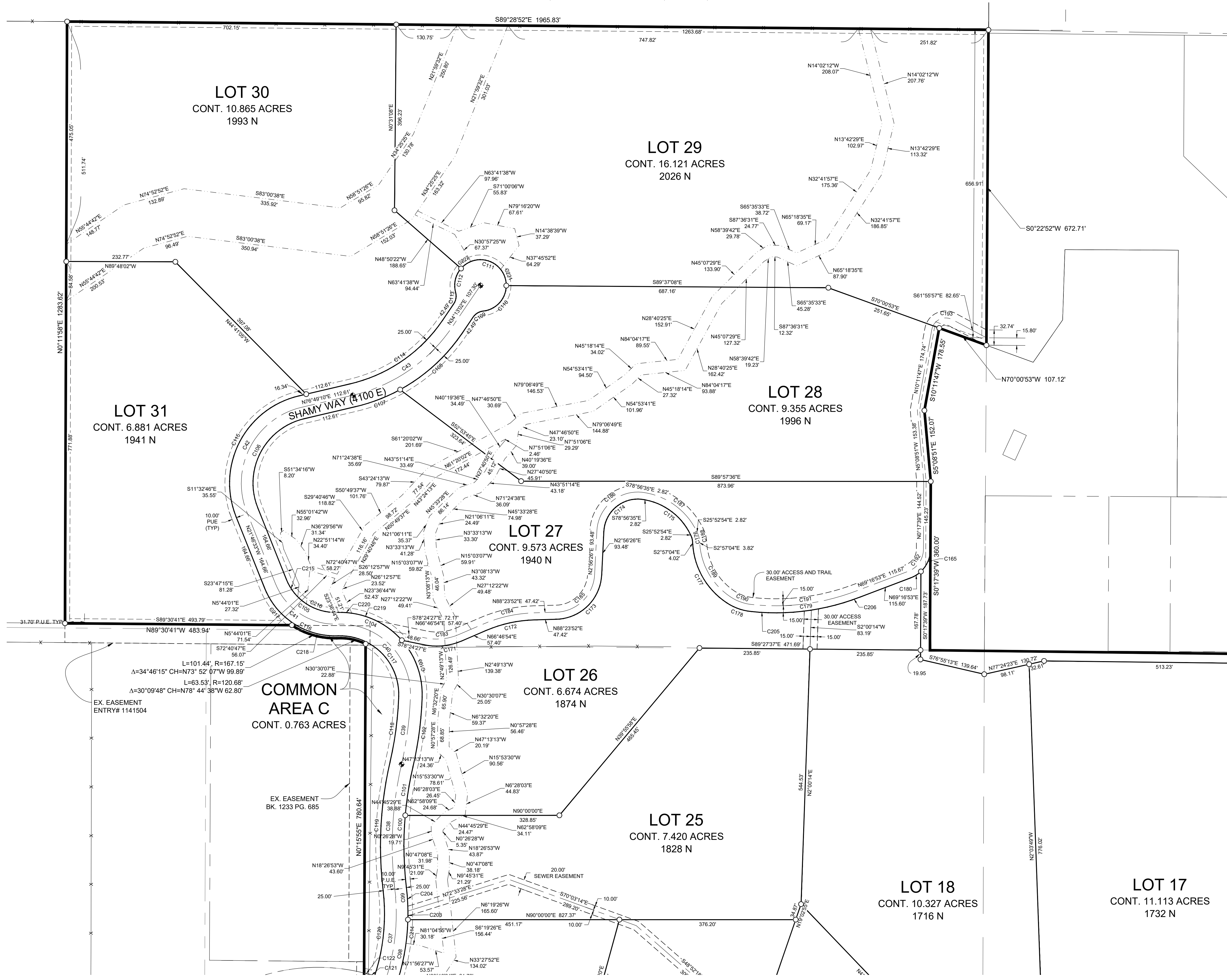

- LEGEND**
- WEBER COUNTY MONUMENT AS NOTED
 - SET 24" REBAR AND CAP MARKED GARDNER ENGINEERING
 - SUBDIVISION BOUNDARY
 - LOT LINE
 - ADJACENT PARCEL
 - SECTION LINE
 - EASEMENT
 - EXISTING FENCE LINE
 - DRAINAGE EASEMENT

DEVELOPER: OSPREY RANCH LLC JOHN LEWIS 3718 NORTH WOLF CREEK DRIVE EDEN, UTAH, 84310 801-430-1507	S5 <hr/> 7	COUNTY RECORDER ENTRY NO. _____ FEE PAID _____ FILED FOR AND RECORDED _____ AT _____ IN BOOK _____ OF OFFICIAL _____ RECORDS, PAGE _____ RECORDED _____ FOR _____ COUNTY RECORDER _____ BY: _____
		<p>GARDNER ENGINEERING CIVIL • LAND PLANNING MUNICIPAL • LAND SURVEYING 5150 SOUTH 375 EAST OGDEN, UT OFFICE: 801.476.0202 FAX: 801.476.0066</p>

R11201 - LEWIS HOMES2105 - OSPREY RANCH SURVEY/OSPREY RANCH PHASE 1 PLAT REVISED LOTS BLOCKING

OSPREY RANCH SUBDIVISION PHASE 1
 LOCATED IN THE SOUTHEAST QUARTER OF SECTION 33 TOWNSHIP 7 NORTH RANGE 1 EAST AND THE
 NORTH HALF OF SECTIONS 3, AND 4 OF TOWNSHIP 6 NORTH, RANGE 1 EAST, SALT LAKE BASE AND
 MERIDIAN, WEBER COUNTY, UTAH, OCTOBER 2022

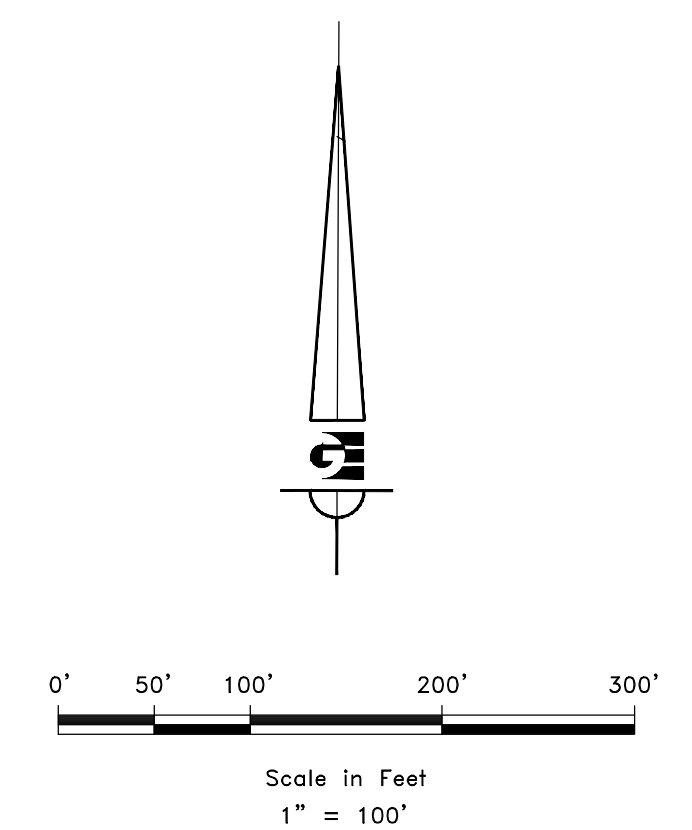
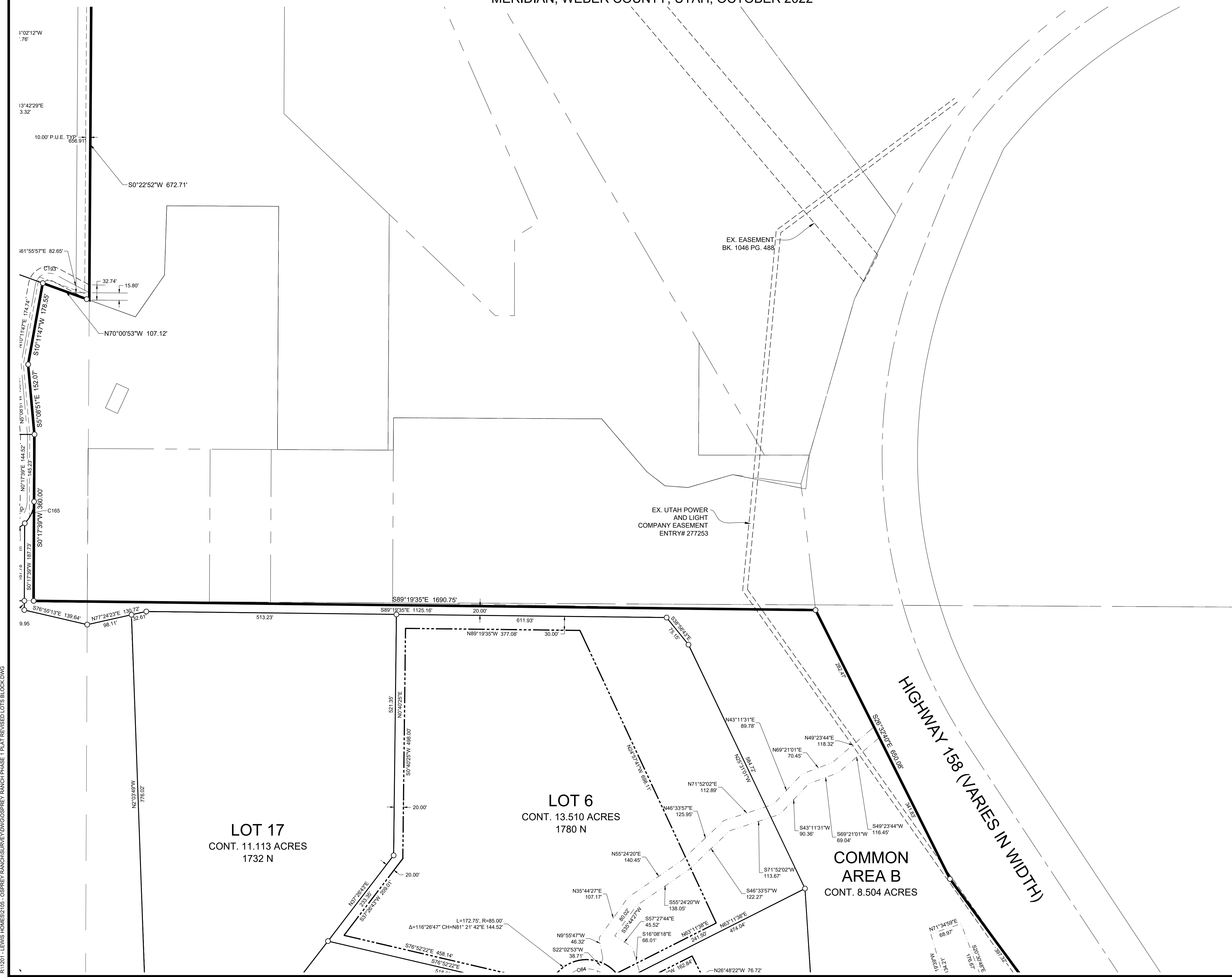

- LEGEND**
- ◆ WEBER COUNTY MONUMENT AS NOTED
 - SET 24" REBAR AND CAP MARKED GARDNER ENGINEERING
 - SUBDIVISION BOUNDARY
 - LOT LINE
 - - - ADJACENT PARCEL
 - - - SECTION LINE
 - - - EASEMENT
 - - - EXISTING FENCE LINE
 - - - BUILDABLE AREA SEE NOTE 4
 - - - DRAINAGE EASEMENT

R11201 - LEWIS HOMES2105 - OSPREY RANCH SURVEY/OSPREY RANCH PHASE 1 PLAT REVISED LOTS BLOCKING

DEVELOPER: OSPREY RANCH LLC JOHN LEWIS 3718 NORTH WOLF CREEK DRIVE EDEN, UTAH, 84310 801-430-1507	S6 <hr/> 7	COUNTY RECORDER ENTRY NO. _____ FEE PAID _____ FILED FOR AND RECORDED _____ AT _____ IN BOOK _____ OF OFFICIAL RECORDS, PAGE _____ RECORDED FOR _____ COUNTY RECORDER BY: _____
		<p>GARDNER ENGINEERING CIVIL • LAND PLANNING MUNICIPAL • LAND SURVEYING 5150 SOUTH 375 EAST OGDEN, UT OFFICE: 801-476-0202 FAX: 801-476-0656</p>

OSPREY RANCH SUBDIVISION PHASE 1

LOCATED IN THE SOUTHEAST QUARTER OF SECTION 33 TOWNSHIP 7 NORTH RANGE 1 EAST AND THE
NORTH HALF OF SECTIONS 3, AND 4 OF TOWNSHIP 6 NORTH, RANGE 1 EAST, SALT LAKE BASE AND
MERIDIAN, WEBER COUNTY, UTAH, OCTOBER 2022

CURVE TABLE					
CURVE #	LENGTH	RADIUS	DELTA	CHORD BEARING	CHORD LENGTH
C7	201.37	100.00	115°22'41"	S53° 33' 12"W	169.03
C8	102.80	150.00	39°16'01"	S23° 46' 09"E	100.80
C9	56.15	150.00	21°26'57"	S32° 40' 41"E	55.83
C10	141.41	150.00	54°00'53"	S5° 03' 14"W	136.23
C11	245.70	150.00	93°51'02"	S78° 59' 12"W	219.14
C12	70.89	280.00	14°30'19"	N61° 20' 27"W	70.70
C13	142.23	212.00	38°26'20"	N87° 48' 47"W	139.58
C14	240.78	150.00	91°58'19"	N61° 02' 47"W	215.75
C15	279.07	150.00	106°35'50"	N68° 21' 32"W	240.53
C16	42.11	150.00	16°05'01"	S50° 18' 02"W	41.97
C17	319.76	150.00	122°08'21"	N76° 40' 18"W	262.56
C18	226.70	150.00	86°35'33"	N58° 53' 54"W	205.73
C19	262.96	150.00	100°26'42"	N51° 58' 20"W	230.56
C20	526.98	743.00	40°38'14"	N22° 04' 06"W	516.00
C21	305.08	294.50	59°21'16"	N72° 03' 51"W	291.62
C22	199.45	323.05	35°22'29"	N84° 03' 14"W	196.30
C23	293.78	530.14	31°45'02"	N82° 14' 30"W	290.03
C24	214.11	248.87	49°17'34"	N73° 28' 14"W	207.57
C25	155.51	286.00	31°09'18"	N64° 24' 06"W	153.61
C26	162.57	141.14	65°59'36"	N46° 58' 57"W	153.73

CURVE TABLE					
CURVE #	LENGTH	RADIUS	DELTA	CHORD BEARING	CHORD LENGTH
C27	155.56	160.00	55°42'17"	N41° 50' 18"W	149.50
C28	30.51	366.00	4°46'35"	N72° 04' 44"W	30.50
C29	67.50	150.92	25°37'34"	N8° 44' 53"E	66.94
C30	86.74	658.38	7°32'54"	N7° 50' 22"W	86.67
C31	49.70	300.00	9°29'29"	N6° 52' 04"W	49.64
C32	177.36	300.00	33°52'21"	N19° 03' 30"W	174.78
C33	84.64	200.00	24°14'46"	N48° 07' 04"W	84.01
C34	202.42	200.00	57°59'16"	N31° 14' 49"W	193.89
C35	14.41	50.00	16°30'50"	N8° 16' 45"E	14.36
C36	284.76	584.25	27°92'56"	N61° 34' 33"E	281.95
C37	212.97	449.46	27°08'57"	N6° 44' 06"E	210.99
C38	267.21	768.94	19°54'37"	N3° 06' 56"E	265.86
C39	145.50	750.45	11°06'31"	N7° 30' 59"E	145.27
C40	246.31	150.00	94°04'59"	N45° 04' 46"W	219.55
C41	188.39	137.15	70°20'42"	N56° 56' 55"W	158.01
C42	285.91	166.15	98°35'43"	N27° 31' 18"E	251.92
C43	263.19	353.97	42°36'07"	N55° 31' 06"E	257.17
C44	257.76	128.00	115°22'41"	S53° 33' 12"W	216.36
C45	44.27	178.00	14°24'86"	S11° 15' 36"E	44.15
C46	77.72	178.00	25°01'83"	S30° 53' 36"E	77.11

CURVE TABLE					
CURVE #	LENGTH	RADIUS	DELTA	CHORD BEARING	CHORD LENGTH
C47	45.67	122.00	21°26'57"	S32° 40' 41"E	45.41
C48	115.01	122.00	54°00'53"	S5° 03' 14"W	110.80
C49	199.84	122.00	93°51'02"	S78° 59' 12"W	178.23
C50	77.97	308.00	14°30'19"	N61° 20' 27"W	77.77
C51	161.01	240.00	38°26'20"	N87° 48' 47"W	158.01
C52	195.84	122.00	91°58'19"	N61° 02' 47"W	175.48
C53	140.50	178.00	45°13'29"	N37° 40' 22"W	136.88
C54	78.72	175.92	25°38'15"	N8° 45' 13"E	78.06
C55	81.64	683.38	6°50'42"	N7° 29' 16"W	81.59
C56	8.39	683.38	0°42'12"	N11° 15' 43"W	8.39
C57	45.56	275.00	9°29'29"	N6° 52' 04"W	45.50
C58	162.15	325.00	28°35'09"	N16° 24' 54"W	160.47
C59	29.99	325.00	5°17'12"	N33° 21' 04"W	29.98
C60	95.21	225.00	24°14'46"	N48° 07' 04"W	94.51
C61	177.11	175.00	57°59'16"	N31° 14' 49"W	169.65
C62	26.01	30.00	49°40'47"	N22° 35' 13"E	25.21
C63	71.26	55.00	74°13'58"	N10° 18' 37"E	66.38
C64	139.69	55.00	145°30'59"	S80° 26' 09"W	105.06
C65	57.22	55.00	59°36'37"	S22° 07' 39"E	54.68
C66	26.01	30.00	49°40'47"	S27° 05' 34"E	25.21

CURVE TABLE					
CURVE #	LENGTH	RADIUS	DELTA	CHORD BEARING	CHORD LENGTH
C130	164.49	188.00	50°07'53"	S3° 06' 44"W	159.30
C131	12.74	188.00	3°53'00"	S30° 07' 11"W	12.74
C133	307.94	188.00	93°51'02"	S78° 59' 12"W	274.65
C135	61.27	242.00	14°30'19"	N61° 20' 27"W	61.10
C137	116.73	174.00	38°26'20"	N87° 48' 47"W	114.56
C139	301.78	188.00	91°58'19"	N61° 02' 47"W	270.41
C141	208.37	112.00	106°35'50"	N68° 21' 32"W	179.59
C143	31.44	112.00	16°05'01"	S50° 18' 02"W	31.34
C145	185.83	188.00	56°38'08"	S70° 34' 36"W	178.36
C147	7.21	25.00	16°30'50"	S8° 16' 45"W	7.18
C149	21.62	75.00	16°30'50"	N8° 16' 45"E	21.54
C150	164.78	188.00	50°13'12"	N40° 42' 44"W	159.56
C151	169.27	112.00	86°35'33"	N58° 53' 54"W	153.61
C152	172.70	188.00	52°37'53"	N75° 52' 44"W	166.69
C153	156.89	188.00	47°48'49"	N25° 39' 23"W	152.37
C154	261.14	705.00	21°13'24"	N12° 21' 41"W	259.65
C155	150.29	705.00	12°12'52"	N29° 04' 49"W	150.01
C156	88.59	705.00	7°11'58"	N38° 47' 14"W	88.53
C157	265.72	256.50	59°21'16"	N72° 03' 51"W	253.99
C158	187.46	361.05	29°44'56"	N86° 52' 01"W	185.36

CURVE TABLE					
CURVE #	LENGTH	RADIUS	DELTA	CHORD BEARING	CHORD LENGTH
C159	35.45	361.05	5°37'34"	N69° 10' 46"W	35.44
C160	272.72	492.14	31°45'02"	N82° 14' 30"W	269.24
C161	85.84	286.87	17°08'40"	N89° 32' 41"W	85.52
C162	160.96	286.87	32°08'54"	N64° 53' 54"W	158.86
C163	134.85	248.00	31°09'18"	N64° 24' 06"W	133.20
C164	158.94	179.14	50°50'06"	N54° 33' 42"W	153.78
C165	52.40	65.00	46°11'25"	S23° 23' 21"W	50.99
C171	81.41	134.00	34°48'39"	N84° 11' 14"E	80.17
C172	105.26	279.00	21°36'58"	N77° 35' 23"E	104.64
C173	148.41	99.50	85°27'27"	N45° 40' 09"E	135.03
C174	123.98	72.40	98°07'00"	N51° 59' 55"E	109.38
C175	125.02	135.00	53°03'41"	S52° 24' 44"E	120.60
C176	14.55	35.00	23°48'55"	S13° 58' 26"E	14.44
C177	150.13	162.79	52°50'24"	S30° 04' 34"E	144.87
C178	56.56	115.01	28°10'38"	S70° 35' 08"E	55.99
C179	235.90	496.27	27°14'06"	N82° 23' 14"E	233.68
C180	25.86	65.00	22°47'50"	N57° 52' 59"E	25.69
C181	106.24	162.15	37°32'20"	S40° 32' 43"E	104.35
C182	92.84	162.15	32°48'22"	S75° 43' 04"E	91.58
C183	72.30	119.00	34°48'39"	N84° 11' 14"E	71.19

CURVE TABLE					
CURVE #	LENGTH	RADIUS	DELTA	CHORD BEARING	CHORD LENGTH
C67	57.13	225.00	14°32'53"	S9° 31' 37"E	56.98
C68	170.59	225.00	43°26'23"	S38° 31' 15"E	166.53
C69	74.06	175.00	24°14'46"	S48° 07' 04"E	73.50
C70	162.58	275.00	33°52'21"	S19° 03' 30"E	160.22
C71	53.84	325.00	9°29'29"	S6° 52' 04"E	53.78
C72	83.44	633.38	7°32'54"	S7° 50' 22"E	83.38
C73	56.29	125.92	25°36'36"	S8° 44' 24"W	55.82
C74	140.50	178.00	45°13'29"	S80° 57' 17"W	136.88
C75	49.97	178.00	16°05'01"	S50° 18' 02"W	49.80
C76	260.07	122.00	122°08'21"	N76° 40' 18"W	213.55
C77	269.02	178.00	86°35'33"	N58° 53' 54"W	244.13
C78	213.88	122.00	100°26'42"	N51° 58' 20"W	187.52
C79	265.89	771.00	19°45'33"	N11° 37' 45"W	264.57
C80	249.08	771.00	18°30'37"	N30° 45' 50"W	248.00
C81	207.36	559.25	21°24'43"	N58° 14' 07"E	206.17
C82	27.80	30.00	53°10'30"	S84° 35' 28"E	26.82
C83	54.10	55.00	56°36'20"	S86° 13' 14"E	51.95
C84	161.36	55.00	168°12'78"	N18° 27' 56"W	109.41
C85	52.53	55.00	54°71'95"	S50° 06' 39"W	50.55
C86	24.46	30.00	46°70'88"	S46° 06' 20"W	23.79

CURVE TABLE					
CURVE #	LENGTH	RADIUS	DELTA	CHORD BEARING	CHORD LENGTH
C87	232.31	609.25	21°84'68"	S58° 32' 12"W	230.90
C89	334.09	322.50	59°21'16"	N72° 03' 51"W	319.35
C90	182.17	295.05	35°22'29"	N84° 03' 14"W	179.29
C91	204.63	558.14	21°00'22"	N76° 52' 10"W	203.48
C92	104.67	558.14	10°44'40"	S87° 15' 19"W	104.51
C93	190.02	220.87	49°17'34"	N73° 28' 14"W	184.21
C94	170.74	314.00	31°09'18"	N64° 24' 06"W	168.64
C95	68.24	113.14	34°33'22"	N62° 42' 04"W	67.21
C96	62.08	113.14	31°26'14"	N29° 42' 16"W	61.30
C97	161.04	188.00	49°04'48"	N38° 31' 33"W	156.16
C98	150.76	474.46	18°12'21"	N10° 35' 29"E	150.13
C99	68.97	474.46	8°19'42"	N2° 40' 32"W	68.91
C100	153.93	743.94	11°51'19"	N0° 54' 43"W	153.66
C101	104.59	743.94	8°03'18"	N9° 02' 35"E	104.50
C102	150.35	775.45	11°06'31"	N7° 30' 59"E	150.11
C103	132.15	175.00	43°15'58"	N19° 40' 16"W	129.03
C104	155.21	175.00	50°49'01"	N66° 42' 45"W	150.17
C105	137.69	112.15	70°20'42"	N56° 56' 55"W	129.21
C106	242.89	141.15	98°35'43"	N27° 31' 18"E	214.01

CURVE TABLE					
CURVE #	LENGTH	RADIUS	DELTA	CHORD BEARING	CHORD LENGTH
C107	102.24	378.97	15°27'29"	N69° 05' 25"E	101.93
C108	179.54	378.97	27°08'38"	N47° 47' 22"E	177.86
C109	26.01	30.00	49°40'47"	N59° 03' 26"E	25.21
C110	80.17	55.00	83°30'58"	N42° 08' 21"E	73.26
C111	133.64	55.00	139°13'14"	N69° 13' 45"W	103.11
C112	54.35	55.00	56°37'23"	S12° 50' 57"W	52.17
C113	26.01	30.00	49°40'47"	S9° 22' 39"W	25.21
C114	244.60	328.97	42°36'07"	S55° 31' 06"W	239.01
C115	328.93	191.15	98°35'43"	S27° 31' 18"W	289.82
C116	199.08	162.15	70°20'42"	S56° 56' 55"E	186.81
C117	205.26	125.00	94°04'59"	S45° 04' 46"E	182.96
C118	140.65	725.45	11°06'31"	S7° 30' 59"W	140.43
C119	275.89	793.94	19°54'37"	S3° 06' 56"W	274.51
C120	185.31	424.46	25°00'49"	S5° 40	