

Project Narrative/Notes/Revisions

1. 2021/11/12 NF - COMPLETED DESIGN FOR CLIENT & CITY REVIEW.
2. 2021/12/06 NF - ADDED 12" CULINARY WATER TO BE INSTALLED.
3. 2021/12/22 NF - REVISED PIPE SIZE & ADDED PROFILES.
4. 2022/01/18 PB - ADDED PUMP DETAILS AND CALCS.
5. 2022/04/01 NF - REVISED TAYLOR WEST WEBER WATER COMMENTS.
6. 2022/04/14 NF - REVISED LATERAL LOCATION & IRRIGATION LAYOUT.
7. 2022/05/03 NF - REROUTED IRRIGATION CONNECTION.
8. 2022/06/03 NF - WEBER COUNTY ENGINEER COMMENTS.

TC GAILEY SUBDIVISION

Improvement Plans

WEBER COUNTY, UTAH
MAY, 2022

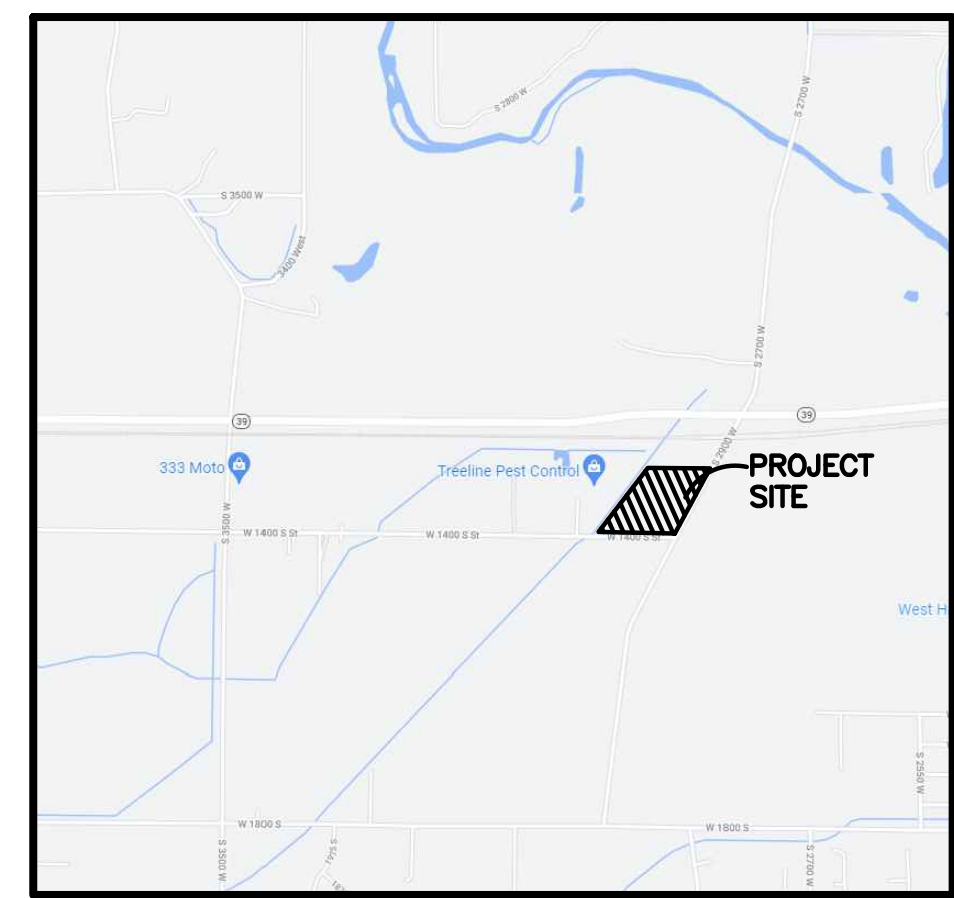

Vicinity Map
NOT TO SCALE

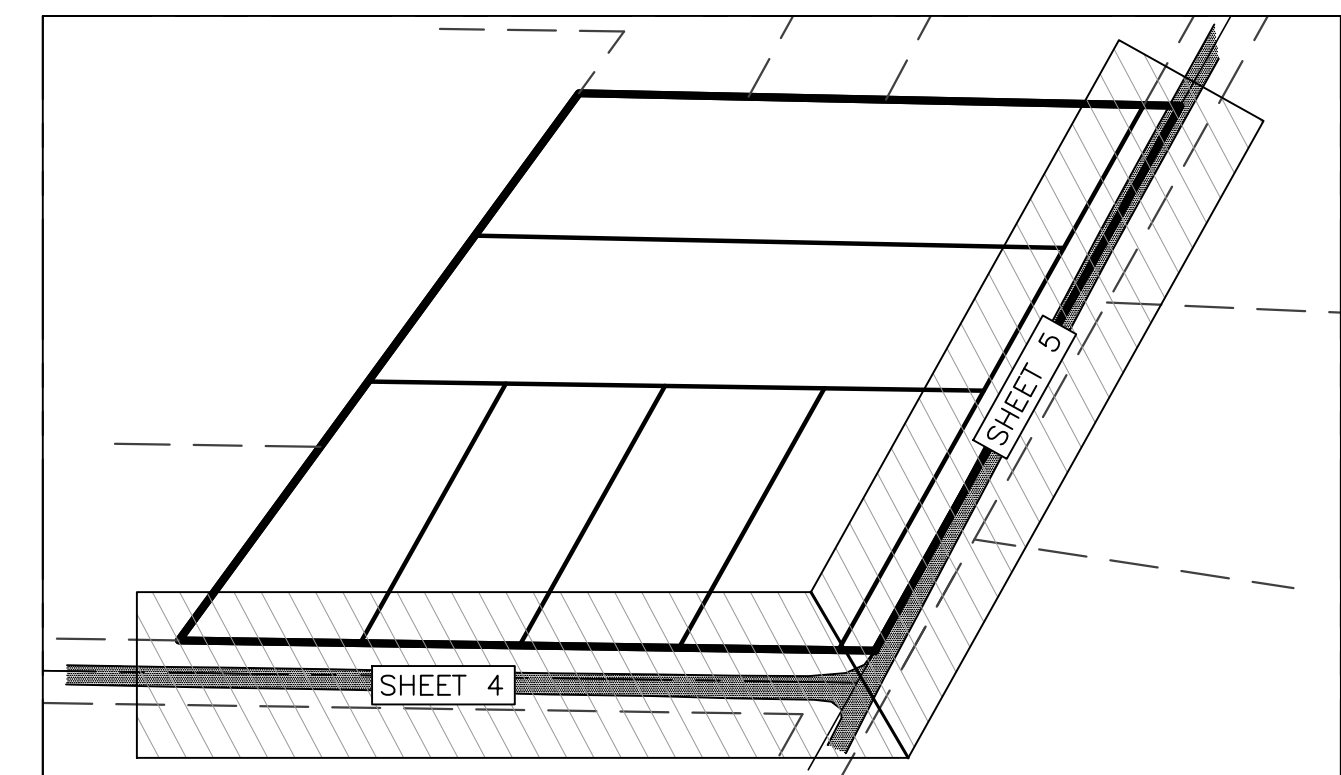

Sheet Index Key Map
NOT TO SCALE

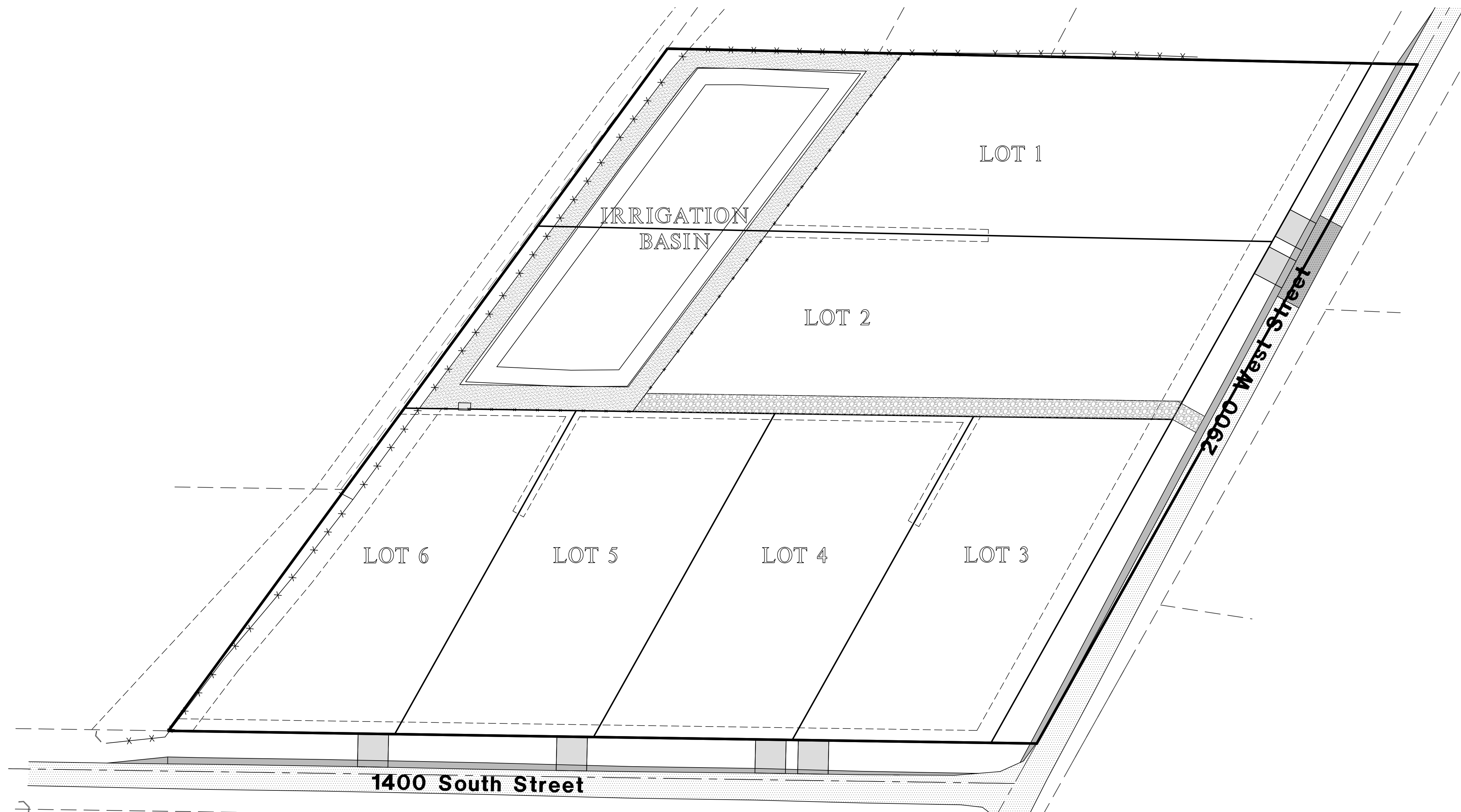

Sheet Index

- Sheet 1 - Cover/Index Sheet
- Sheet 2 - Notes/Legend
- Sheet 3 - Grading & Utility Plan
- Sheet 4 - 1400 South Street
- Sheet 5 - 2900 West Street
- Sheet 6 - Details
- Sheet 7 - Storm Water Pollution Prevention Plan Exhibit
- Sheet 8 - Storm Water Pollution Prevention Plan Details

Surveyor:
Trevor Hatch
Reeve & Associates, Inc.
5160 South 1500 West
Riverdale, Utah, 84405
PH: (801) 621-3100

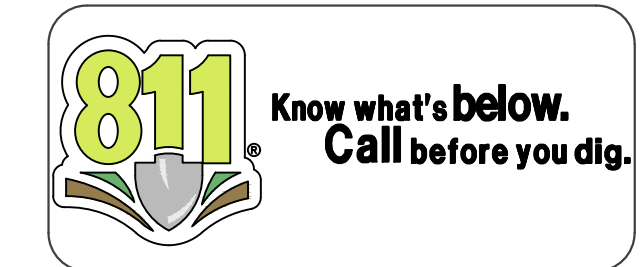

Developer Contact:
Jed Schenck
TDGailey21@gmail.com
1243 E 6600 S
Unitah, UT. 84405
PH: (499) 499-9774

Project Contact:
Jeremy Draper
Reeve & Associates, Inc.
5160 South 1500 West
Riverdale, Utah, 84405
PH: (801) 621-3100

Engineer's Notice To Contractors

THE EXISTENCE AND LOCATION OF ANY UNDERGROUND UTILITY PIPES OR STRUCTURES SHOWN ON THESE PLANS WERE OBTAINED FROM AVAILABLE INFORMATION PROVIDED BY OTHERS. THE LOCATIONS SHOWN ARE APPROXIMATE AND SHALL BE CONFIRMED IN THE FIELD BY THE CONTRACTOR, SO THAT ANY NECESSARY ADJUSTMENT CAN BE MADE IN ALIGNMENT AND/OR GRADE OF THE PROPOSED IMPROVEMENT. THE CONTRACTOR IS REQUIRED TO CONTACT THE UTILITY COMPANIES AND TAKE DUE PRECAUTIONARY MEASURE TO PROTECT ANY UTILITY LINES SHOWN, AND ANY OTHER LINES OBTAINED BY THE CONTRACTOR'S RESEARCH, AND OTHERS NOT OF RECORD OR NOT SHOWN ON THESE PLANS.

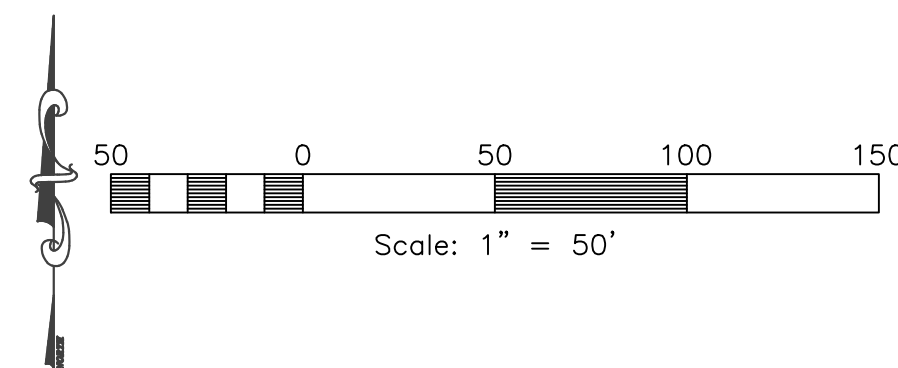

Reeve & Associates, Inc.

RA

5160 SOUTH 1500 WEST, RIVERDALE, UTAH 84405
TEL: (801) 621-3100 www.reeve-assoc.com

LAND PLANNERS • CIVIL ENGINEERS • LAND SURVEYORS
TRAFFIC ENGINEERS • STRUCTURAL ENGINEERS • LANDSCAPE ARCHITECTS

DATE	DESCRIPTION
2021.12.06. NF	Added 12" Water
2022.01.18. PB	Added Pump Det.
2022.04.01. NF	Taylor West Weber
2022.04.14. NF	Utility Location
2022.05.03. NF	Relocated Irrigation
2022.05.03. NF	Weber County Contm

TC Gailey Subdivision
WEBER COUNTY, UTAH

Cover/Index Sheet

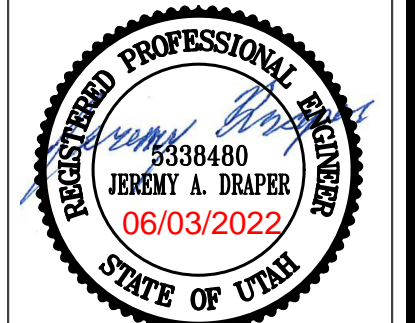

Project Info.
Engineer: JEREMY A. DRAPER, P.E.
Drafted: N. FICKLIN
Begin Date: NOVEMBER, 2021
Name: TC GAILEY SUBDIVISION
Number: 7713-01

General Notes:

- ALL CONSTRUCTION MUST STRICTLY FOLLOW THE STANDARDS AND SPECIFICATIONS SET FORTH BY: GOVERNING UTILITY MUNICIPALITY, GOVERNING CITY OR COUNTY (S.D.), FEDERAL AGENCIES, STATE AGENCIES, AMERICAN PUBLIC WORKS ASSOCIATION (APWA), AND THE DESIGN ENGINEER. THE ORDER LISTED ABOVE IS ARRANGED BY SENIORITY. IF A CONSTRUCTION PRACTICE IS NOT SPECIFIED BY ANY OF THE LISTED SOURCES, CONTRACTOR MUST CONTACT DESIGN ENGINEER FOR DIRECTION.
- CONTRACTOR TO STRICTLY FOLLOW GEOTECHNICAL RECOMMENDATIONS FOR THIS PROJECT. ALL GRADING INCLUDING BUT NOT LIMITED TO CUT, FILL, COMPACTION, ASPHALT SECTION, SUBBASE, TRENCH EXCAVATION/BACKFILL, SITE GRUBBING, RETAINING WALLS AND FOOTINGS MUST BE COORDINATED DIRECTLY WITH THE PROJECT GEOTECHNICAL ENGINEER.
- TRAFFIC CONTROL, STRIPING & SIGNAGE TO CONFORM TO CURRENT GOVERNING AGENCIES TRANSPORTATION ENGINEER'S MANUAL AND MANUAL OF UNIFORM TRAFFIC CONTROL DEVICES.
- ANY AREA OUTSIDE THE LIMIT OF WORK THAT IS DISTURBED SHALL BE RESTORED TO ITS ORIGINAL CONDITION AT NO COST TO OWNER.
- CONSULT ALL OF THE DRAINAGE DISTRICTS AND NEARBY MUNICIPALITIES FOR REQUIREMENTS BEFORE COMMENCING CONSTRUCTION. CONTRACTOR SHALL DEFEND, INDEMNIFY AND HOLD THE OWNER AND THE ENGINEERS HARMLESS FROM ANY AND ALL LIABILITY, REAL OR ALLEGED, IN CONNECTION WITH THE PERFORMANCE OF WORK ON THIS PROJECT.
- AT ALL LOCATIONS WHERE EXISTING PAVEMENT ABUS NEW CONSTRUCTION, THE EDGE OF THE EXISTING PAVEMENT SHALL BE SAWCUT TO A CLEAN, SMOOTH EDGE.
- ALL CONSTRUCTION AND MATERIALS SHALL BE IN ACCORDANCE WITH THE MOST RECENT, ADOPTED EDITION OF ADA ACCESSIBILITY GUIDELINES.
- PRIOR TO STARTING CONSTRUCTION, THE CONTRACTOR SHALL BE RESPONSIBLE FOR MAKING SURE THAT ALL REQUIRED PERMITS AND APPROVALS HAVE BEEN OBTAINED. NO CONSTRUCTION OR FABRICATION SHALL BEGIN UNTIL THE CONTRACTOR HAS RECEIVED THOROUGHLY REVIEWED PLANS AND OTHER DOCUMENTS APPROVED BY ALL OF THE PERMITTING AUTHORITIES.
- CONTRACTOR IS RESPONSIBLE FOR SCHEDULING AND NOTIFYING ENGINEER OR INSPECTING AUTHORITY 48 HOURS IN ADVANCE OF COVERING UP ANY PHASE OF CONSTRUCTION REQUIRING OBSERVATION.
- ANY WORK IN THE PUBLIC RIGHT-OF-WAY WILL REQUIRE PERMITS FROM THE APPROPRIATE CITY, COUNTY OR STATE AGENCY CONTROLLING THE ROAD, INCLUDING OBTAINING REQUIRED INSPECTIONS.
- ALL DIMENSIONS, GRADES AND ELEVATIONS SHOWN ON THE PLANS SHALL BE VERIFIED BY THE CONTRACTOR PRIOR TO CONSTRUCTION. CONTRACTOR SHALL NOTIFY ENGINEER OF ANY DISCREPANCIES PRIOR TO PROCEEDING WITH CONSTRUCTION FOR NECESSARY PLAN OR GRADE CHANGES.
- CONTRACTOR MUST VERIFY ALL EXISTING CONDITIONS BEFORE BIDDING AND BRING UP ANY QUESTIONS BEFOREHAND.
- SITE GRADING SHALL BE PERFORMED IN ACCORDANCE WITH THESE PLANS AND SPECIFICATIONS AND THE RECOMMENDATIONS SET FORTH BY THE GEOTECHNICAL ENGINEER.
- CATCH SLOPES SHALL BE GRADED AS SPECIFIED ON GRADING PLANS.
- CONTRACTOR SHALL BE RESPONSIBLE FOR ALL FLAGGING, CAUTION SIGNS, LIGHTS, BARRICADES, FLAGMEN, AND ALL OTHER DEVICES NECESSARY FOR PUBLIC SAFETY.
- CONTRACTOR SHALL, AT THE TIME OF BIDDING AND THROUGHOUT THE PERIOD OF THE CONTRACT, BE LICENSED IN THE STATE WHERE THE PROJECT IS LOCATED AND SHALL BE BONDBLE FOR AN AMOUNT EQUAL TO OR GREATER THAN THE AMOUNT BID AND TO DO THE TYPE OF WORK CONTEMPLATED IN THE PLANS AND SPECIFICATIONS. CONTRACTOR SHALL BE SKILLED AND REGULARLY ENGAGED IN THE GENERAL CLASS AND TYPE OF WORK CALLED FOR IN THE PLANS AND SPECIFICATIONS.
- CONTRACTOR SHALL INSPECT THE SITE OF THE WORK PRIOR TO BIDDING TO SATISFY HIMSELF BY PERSONAL EXAMINATION OR BY SUCH OTHER MEANS AS HE MAY PREFER OF THE LOCATIONS OF THE PROPOSED WORK AND OF THE ACTUAL CONDITIONS OF AND AT THE SITE OF WORK. IF, DURING THE COURSE OF HIS EXAMINATION, A BIDDER FINDS FACTS OR CONDITIONS WHICH APPEAR TO HIM TO BE IN CONFLICT WITH THE LETTER OR SPIRIT OF THE PROJECT PLANS AND SPECIFICATIONS, HE SHALL CONTACT THE ENGINEER FOR ADDITIONAL INFORMATION AND EXPLANATION BEFORE SUBMITTING HIS BID. SUBMISSION OF A BID BY THE CONTRACTOR SHALL CONSTITUTE ACKNOWLEDGMENT THAT, IF AWARDED THE CONTRACT, HE HAS RELIED AND IS RELYING ON HIS OWN EXAMINATION OF (1) THE SITE OF THE WORK, (2) ACCESS TO THE SITE, AND (3) ALL OTHER DATA AND MATTERS REQUISITE TO THE FULFILLMENT OF THE WORK AND ON HIS OWN KNOWLEDGE OF EXISTING FACILITIES ON AND IN THE VICINITY OF THE SITE OF THE WORK TO BE CONSTRUCTED UNDER THIS CONTRACT. THE INFORMATION PROVIDED BY THE ENGINEER IS NOT INTENDED TO BE A SUBSTITUTE FOR, OR A SUPPLEMENT TO, THE INDEPENDENT VERIFICATION BY THE CONTRACTOR TO THE EXTENT SUCH NECESSARY INVESTIGATION OF SITE CONDITIONS IS DEEMED NECESSARY OR DESIRABLE BY THE CONTRACTOR. CONTRACTOR SHALL ACKNOWLEDGE THAT HE HAS NOT RELIED SOLELY UPON OWNER-OR ENGINEER-FURNISHED INFORMATION REGARDING SITE CONDITIONS IN PREPARING AND SUBMITTING HIS BID.
- CONTRACTOR SHALL BE RESPONSIBLE TO PROVIDE ALL WATER, POWER, SANITARY FACILITIES AND TELEPHONE SERVICES AS REQUIRED FOR THE CONTRACTOR'S USE DURING CONSTRUCTION.
- CONTRACTOR SHALL BE HELD RESPONSIBLE FOR ANY FIELD CHANGES MADE WITHOUT PRIOR WRITTEN AUTHORIZATION FROM THE OWNER, ENGINEER, AND/OR GOVERNING AGENCIES.
- CONTRACTOR SHALL EXERCISE DUE CAUTION AND SHALL CAREFULLY PRESERVE BENCH MARKS, CONTROL POINTS, REFERENCE POINTS AND ALL SURVEY STAKES, AND SHALL BEAR ALL EXPENSES FOR REPLACEMENT AND/OR ERRORS CAUSED BY THEIR UNNECESSARY LOSS OR DISTURBANCE.
- CONTRACTOR SHALL ASSUME SOLE AND COMPLETE RESPONSIBILITY FOR JOBSITE CONDITIONS DURING THE COURSE OF CONSTRUCTION OF THIS PROJECT. INCLUDING SAFETY OF ALL PERSONS AND PROPERTY. THIS REQUIREMENT SHALL APPLY TO ALL MATERIAL AND WORKMANSHIP SHALL CONFORM TO GOVERNING AGENCIES ORDINANCES AND ALL WORK SHALL BE SUBJECT TO INSPECTION BY THE COUNTRIES. ALSO, INSPECTORS WILL HAVE THE RIGHT TO CHANGE THE FACILITIES AS NEEDED.
- CONTRACTOR SHALL MAINTAIN A NEATLY MARKED SET OF FULL-SIZE AS-BUILT RECORD DRAWINGS SHOWING THE FINAL LOCATION AND LAYOUT OF ALL STRUCTURES AND OTHER FACILITIES. AS-BUILT RECORD DRAWINGS SHALL REFLECT CHANGE ORDERS, ACCOMMODATIONS, AND ADJUSTMENTS TO ALL IMPROVEMENTS CONSTRUCTED WHERE NECESSARY. SUPPLEMENTAL DRAWINGS SHALL BE PREPARED AND SUBMITTED BY THE CONTRACTOR. PRIOR TO ACCEPTANCE OF THE PROJECT, THE CONTRACTOR SHALL DELIVER TO THE ENGINEER ONE SET OF NEATLY MARKED AS-BUILT RECORD DRAWINGS SHOWING THE INFORMATION REQUIRED ABOVE. AS-BUILT RECORD DRAWINGS SHALL BE REVIEWED AND THE COMPLETE AS-BUILT RECORD DRAWING SET SHALL BE CURRENT WITH ALL CHANGES AND DEVIATIONS REDLINED AS A PRECONDITION TO THE FINAL PROGRESS PAYMENT APPROVAL AND/OR FINAL ACCEPTANCE.
- WHERE THE PLANS OR SPECIFICATIONS DESCRIBE PORTIONS OF THE WORK IN GENERAL TERMS BUT NOT IN COMPLETE DETAIL, IT IS UNDERSTOOD THAT ONLY THE BEST GENERAL PRACTICE IS TO PREVAIL AND THAT ONLY MATERIALS AND WORKMANSHIP OF THE HIGHEST QUALITY ARE TO BE USED.
- CONTRACTOR SHALL BE SKILLED AND REGULARLY ENGAGED IN THE GENERAL CLASS AND TYPE OF WORK CALLED FOR IN THE PROJECT PLANS AND SPECIFICATIONS. THEREFORE, THE OWNER IS RELYING UPON THE EXPERIENCE AND EXPERTISE OF THE CONTRACTOR. PRICES PROVIDED WITHIN THE CONTRACT DOCUMENTS SHALL INCLUDE ALL LABOR AND MATERIALS NECESSARY AND PROPER FOR THE WORK CONTEMPLATED AND THAT THE WORK BE COMPLETED IN ACCORDANCE WITH THE TRUE INTENT AND PURPOSE OF THESE PLANS AND SPECIFICATIONS. THE CONTRACTOR SHALL BE COMPETENT, KNOWLEDGEABLE AND HAVE SPECIAL SKILLS IN THE NATURE, EXTENT AND INHERENT CONDITIONS OF THE WORK TO BE PERFORMED. CONTRACTOR SHALL ALSO ACKNOWLEDGE THAT THERE ARE CERTAIN PECULIAR AND INHERENT CONDITIONS EXISTENT IN THE CONSTRUCTION OF THE PARTICULAR FACILITIES WHICH MAY CREATE, DURING THE CONSTRUCTION PROGRAM, UNUSUAL OR UNSAFE CONDITIONS HAZARDOUS TO PERSONS, PROPERTY AND THE ENVIRONMENT. CONTRACTOR SHALL BE AWARE OF SUCH PECULIAR RISKS AND HAVE THE SKILL AND EXPERIENCE TO FORESEE AND TO ADOPT PROTECTIVE MEASURES TO ADEQUATELY AND SAFELY PERFORM THE CONSTRUCTION WORK WITH RESPECT TO SUCH HAZARDS.
- CONTRACTOR SHALL BE RESPONSIBLE FOR THE REMOVAL OF ALL STRIPING AND/OR PAVEMENT MARKINGS NECESSARY TO THE EXISTING STRIPING INTO FUTURE STRIPING. METHOD OF REMOVAL SHALL BE BY GRINDING OR SANDBLASTING.
- CONTRACTOR SHALL PROVIDE ALL SHORINGS, BRACING, SLOPING OR OTHER PROVISIONS NECESSARY TO PROTECT WORKMEN FOR ALL AREAS TO BE EXCAVATED TO A DEPTH OF 4 FEET OR MORE. FOR EXCAVATIONS 4 FEET OR MORE IN DEPTH, THE CONTRACTOR SHALL COMPLY WITH LOCAL, STATE AND NATIONAL SAFETY CODES, ORDINANCES, OR REQUIREMENTS FOR EXCAVATION AND TRENCHES.
- ALL EXISTING GATES AND FENCES TO REMAIN UNLESS OTHERWISE NOTED ON PLANS. PROTECT ALL GATES AND FENCES FROM DAMAGE.

Utility Notes:

- CONTRACTOR SHALL COORDINATE LOCATION OF NEW "DRY UTILITIES" WITH THE APPROPRIATE UTILITY COMPANY, INCLUDING BUT NOT LIMITED TO: TELEPHONE SERVICE, GAS SERVICE, CABLE, POWER, INTERNET.
- EXISTING UTILITIES HAVE BEEN SHOWN ON THE PLANS USING A COMBINATION OF ON-SITE SURVEYS (BY OTHERS), PRIOR TO COMMENCING ANY WORK, IT SHALL BE THE CONTRACTOR'S RESPONSIBILITY TO HAVE EACH UTILITY COMPANY LOCATE IN THE FIELD, THEIR MAIN AND SERVICE LINES 48 HOURS IN ADVANCE OF PERFORMING ANY EXCAVATION WORK. THE CONTRACTOR SHALL RECORD THE BLUE STAKES ORDER NUMBER AND FURNISH ORDER NUMBER TO OWNER AND ENGINEER PRIOR TO ANY EXCAVATION. IT WILL BE THE CONTRACTOR'S SOLE RESPONSIBILITY TO DIRECTLY CONTACT ANY OTHER UTILITY COMPANIES THAT ARE NOT MEMBERS OF BLUE STAKES. IT SHALL BE THE CONTRACTOR'S SOLE RESPONSIBILITY TO PROTECT ALL EXISTING UTILITIES SO THAT NO DAMAGE RESULTS TO THEM DURING THE PERFORMANCE OF THIS CONTRACT. ANY REPAIRS NECESSARY TO DAMAGE UTILITIES SHALL BE PAID FOR BY THE CONTRACTOR. THE CONTRACTOR SHALL BE REQUIRED TO COOPERATE WITH OTHER CONTRACTORS AND UTILITY COMPANIES INSTALLING NEW STRUCTURES, UTILITIES AND SERVICE TO THE PROJECT.
- CONTRACTOR SHALL POT HOLE ALL UTILITIES TO DETERMINE IF CONFLICTS EXIST PRIOR TO BEGINNING ANY EXCAVATION. NOTIFY ENGINEER OF ANY CONFLICTS. CONTRACTOR SHALL VERIFY LOCATION AND INVERTS OF EXISTING UTILITIES TO WHICH NEW UTILITIES WILL BE CONNECTED. PRIOR TO COMMENCING ANY EXCAVATION WORK THE CONTRACTOR SHALL NOTIFY ALL UTILITY COMPANIES IN ACCORDANCE WITH THE REQUIRED PROCEDURES.
- CARE SHOULD BE TAKEN IN ALL EXCAVATIONS DUE TO POSSIBLE EXISTENCE OF UNRECORDED UTILITY LINES. EXCAVATION REQUIRED WITHIN PROXIMITY OF EXISTING UTILITY LINES SHALL BE DONE BY HAND. CONTRACTOR SHALL REPAIR ANY DAMAGE TO EXISTING UTILITY LINES OR STRUCTURES INCURRED DURING CONSTRUCTION OPERATIONS AT HIS EXPENSE.
- ALL VALVES AND MANHOLE COVERS SHALL BE RAISED OR LOWERED TO MEET FINISHED GRADE.
- CONTRACTOR SHALL CUT PIPES OFF FLUSH WITH THE INSIDE WALL OF THE BOX OR MANHOLE.
- CONTRACTOR SHALL GROUT AT CONNECTION OF PIPE TO BOX WITH NON-SHRINKING GROUT, INCLUDING PIPE VOIDS LEFT BY CUTTING PROCESS TO A SMOOTH FINISH.
- CONTRACTOR SHALL GROUT WITH NON-SHRINK GROUT BETWEEN GRADE RINGS AND BETWEEN BOTTOM OF INLET LID FRAME AND TOP OF CONCRETE BOX
- SILT AND DEBRIS IS TO BE CLEANED OUT OF ALL STORM DRAIN BOXES. CATCH BASINS ARE TO BE MAINTAINED IN A CLEANED CONDITION AS NEEDED UNTIL AFTER THE FINAL BOND RELEASE INSPECTION.
- CONTRACTOR SHALL CLEAN ASPHALT, TAR OR OTHER ADHESIVES OFF OF ALL MANHOLE LIDS AND INLET GRATES TO ALLOW ACCESS.
- EACH TRENCH SHALL BE EXCAVATED SO THAT THE PIPE CAN BE LAID TO THE ALIGNMENT AND GRADE AS REQUIRED. THE TRENCH WALL SHALL BE SO BRACED THAT THE WORKMEN MAY WORK SAFELY AND EFFICIENTLY. ALL TRENCHES SHALL BE DRAINED SO THE PIPE LAYING MAY TAKE PLACE IN DE-WATERED CONDITIONS.
- CONTRACTOR SHALL PROVIDE AND MAINTAIN AT ALL TIMES AMPLE MEANS AND DEVICES WITH WHICH TO REMOVE PROMPTLY AND TO PROPERLY DISPOSE OF ALL WATER ENTERING THE TRENCH EXCAVATION.
- MAINTAIN A MINIMUM 18" VERTICAL SEPARATION DISTANCE BETWEEN ALL UTILITY CROSSINGS.
- CONTRACTOR SHALL START INSTALLATION AT LOW POINT OF ALL NEW GRAVITY UTILITY LINES.
- ALL BOLTED FITTINGS MUST BE GREASED AND WRAPPED.
- UNLESS SPECIFICALLY NOTED OTHERWISE, MAINTAIN AT LEAST 2 FEET OF COVER OVER ALL STORM DRAIN LINES AT ALL TIMES (INCLUDING DURING CONSTRUCTION).
- ALL WATER LINES SHALL BE INSTALLED A MINIMUM OF 48" BELOW FINISHED GRADE.
- ALL SEWER LINES AND SEWER SERVICES SHALL HAVE A MINIMUM SEPARATION OF 10 FEET, PIPE EDGE TO PIPE EDGE, FROM THE WATER LINES. IF A 10 FOOT SEPARATION CAN NOT BE MAINTAINED, THE SEWER LINE AND WATER LINE SHALL BE LAID IN SEPARATE TRENCHES AND THE BOTTOM OF THE WATER LINE SHALL BE AT LEAST 18" ABOVE THE TOP OF THE SEWER LINE.
- CONTRACTOR SHALL INSTALL THRUST BLOCKING AT ALL WATERLINE ANGLE POINTS AND TEES.
- ALL UNDERGROUND UTILITIES SHALL BE IN PLACE PRIOR TO INSTALLATION OF CURB, GUTTER, SIDEWALK AND STREET PAVING.
- CONTRACTOR SHALL INSTALL MAGNETIC LOCATING TAPE CONTINUOUSLY OVER ALL NONMETALLIC PIPE.
- THRUST BLOCKS & RESTRAINED JOINTS WITH MEGA-LUG ADAPTERS REQUIRED ON ALL BENDS AND FITTINGS USING BLUE BOLTS.
- PROTECT ALL BOLTS FROM BEING ENCASED IN CONCRETE. INSTALL PER MANUFACTURER RECOMMENDATIONS.
- ALL CULINARY WATER FACILITIES SHALL MEET THE REQUIREMENTS OF THE TAYLOR-WEST WEBER WATER IMPROVEMENT DISTRICT. STANDARD DETAILS AND CONSTRUCTION SPECIFICATION ARE AVAILABLE UPON REQUEST TO TAYLORWESTWEBER@MSM.COM OR 801.731.1668. THE DISTRICT SHALL BE NOTIFIED AT LEAST 24 HOURS PRIOR TO ANY PRECONSTRUCTION MEETINGS OR CONSTRUCTION ACTIVITY.

Notice to Contractor:

THE CONTRACTOR IS SPECIFICALLY CAUTIONED THAT THE LOCATION AND/OR ELEVATION OF EXISTING UNDERGROUND UTILITIES AS SHOWN ON THESE PLANS ARE BASED UPON RECORDS OF THE VARIOUS UTILITY COMPANIES AND/OR MUNICIPALITIES AND, WHERE POSSIBLE, PUBLIC WORKS. MEASUREMENTS TAKEN IN THE FIELD. THE INFORMATION IS NOT TO BE RELIED UPON AS BEING EXACT OR COMPLETE. THE CONTRACTOR MUST CALL THE APPROPRIATE UTILITY COMPANIES AT LEAST 48 HOURS BEFORE ANY EXCAVATION TO REQUEST EXACT FIELD LOCATION OF UTILITIES. IT SHALL BE THE RESPONSIBILITY OF THE CONTRACTOR TO RELOCATE ALL EXISTING UTILITIES WHICH CONFLICT WITH THE PROPOSED IMPROVEMENTS SHOWN ON THESE PLANS.

THE CONTRACTOR AGREES THAT THEY SHALL ASSUME SOLE AND COMPLETE RESPONSIBILITY FOR JOB SITE CONDITIONS DURING THE COURSE OF CONSTRUCTION OF THIS PROJECT, INCLUDING SAFETY OF ALL PERSONS AND PROPERTY. THIS REQUIREMENT SHALL APPLY CONTINUOUSLY AND NOT BE LIMITED TO NORMAL WORKING HOURS; AND THAT THE CONTRACTOR SHALL DEFEND, INDEMNIFY AND HOLD THE OWNER AND THE ENGINEERS HARMLESS FROM ANY AND ALL LIABILITY, REAL OR ALLEGED, IN CONNECTION WITH THE PERFORMANCE OF WORK ON THIS PROJECT.

- NOTE:
- SAWCUT EXISTING ASPHALT INSIDE FROM OUTER EDGE FOR TACK SEAL OF NEW ASPHALT
 - CONTRACTOR TO VERIFY 2% MIN. AND 5% MAX SLOPE FROM EDGE OF ASPHALT TO LIP OF GUTTER

Survey Control Note:

THE CONTRACTOR OR SURVEYOR SHALL BE RESPONSIBLE FOR FOLLOWING THE NATIONAL SOCIETY OF PROFESSIONAL SURVEYORS (NPS) MODEL STANDARDS FOR ANY SURVEYING OR CONSTRUCTION LAYOUT TO BE COMPLETED USING REEVE & ASSOCIATES, INC. SURVEY DATA OR CONSTRUCTION IMPROVEMENT PLANS. PRIOR TO PROCEEDING WITH CONSTRUCTION STAKING, THE SURVEYOR SHALL BE RESPONSIBLE FOR VERIFYING HORIZONTAL CONTROL FROM THE SURVEY MONUMENTS AND FOR VERIFYING ANY ADDITIONAL CONTROL POINTS SHOWN ON AN ALTA SURVEY IMPROVEMENT PLAN, OR ANY ELECTRONIC DATA PROVIDED. THE SURVEYOR SHALL ALSO USE THE BENCHMARKS AS SHOWN ON THE PLAN, AND VERIFY THEM AGAINST NO LESS THAN FIVE (5) EXISTING HARD IMPROVEMENT ELEVATIONS INCLUDED ON THESE PLANS OR ON ELECTRONIC DATA PROVIDED. IF ANY DISCREPANCIES ARE ENCOUNTERED, THE SURVEYOR SHALL IMMEDIATELY NOTIFY REEVE & ASSOCIATES, INC. AND RESOLVE THE DISCREPANCIES BEFORE PROCEEDING WITH ANY CONSTRUCTION STAKING.

Erosion Control General Notes:

THE CONTRACTOR TO USE BEST MANAGEMENT PRACTICES FOR PROVIDING EROSION CONTROL FOR CONSTRUCTION OF THIS PROJECT. ALL MATERIAL AND WORKMANSHIP SHALL CONFORM TO GOVERNING AGENCIES ORDINANCES AND ALL WORK SHALL BE SUBJECT TO INSPECTION BY THE COUNTRIES. ALSO, INSPECTORS WILL HAVE THE RIGHT TO CHANGE THE FACILITIES AS NEEDED.

CONTRACTOR SHALL KEEP THE SITE WATERED TO CONTROL DUST. CONTRACTOR TO LOCATE A NEARBY HYDRANT FOR USE AND TO INSTALL TEMPORARY METER. CONSTRUCTION WATER COST TO BE INCLUDED IN BID.

WHEN GRADING OPERATIONS ARE COMPLETED AND THE DISTURBED GROUND IS LEFT OPEN FOR 14 DAYS OR MORE, THE AREA SHALL BE FURROWED PARALLEL TO THE CONTOURS.

THE CONTRACTOR SHALL MODIFY EROSION CONTROL MEASURES TO ACCOMMODATE PROJECT PLANNING.

ALL ACCESS TO PROPERTY WILL BE FROM PUBLIC RIGHT-OF-WAYS. THE CONTRACTOR IS REQUIRED BY STATE AND FEDERAL REGULATIONS TO PREPARE A STORM WATER POLLUTION PREVENTION PLAN AND FILE A "NOTICE OF INTENT" WITH THE GOVERNING AGENCIES.

Maintenance:

ALL BEST MANAGEMENT PRACTICES (BMP'S) SHOWN ON THIS PLAN MUST BE MAINTAINED AT ALL TIMES UNTIL PROJECT CLOSE-OUT.

THE CONTRACTOR'S RESPONSIBILITY SHALL INCLUDE MAKING BI-WEEKLY CHECKS ON ALL EROSION CONTROL MEASURES TO DETERMINE IF REPAIR OR SEDIMENT REMOVAL IS NECESSARY. CHECKS SHALL BE DOCUMENTED AND COPIES OF THE INSPECTIONS KEPT ON SITE.

SEDIMENT DEPOSITS SHOULD BE REMOVED AFTER EACH RAINFALL. THEY MUST BE REMOVED WHEN THE LEVEL OF DEPOSITION REACHES APPROXIMATELY ONE-HALF THE HEIGHT OF BARRIER.

SEDIMENT TRACKED ONTO PAVED ROADS MUST BE CLEANED UP AS SOON AS PRACTICAL, BUT IN NO CASE LATER THAN THE END OF THE NORMAL WORK DAY. THE CLEAN UP WILL INCLUDE SWEEPING OF THE TRACKED MATERIAL, PICKING IT UP, AND DEPOSITING IT TO A CONTAINED AREA.

EXPOSED SLOPES:

- ANY EXPOSED SLOPE THAT WILL REMAIN UNTOUCHED FOR LONGER THAN 14 DAYS MUST BE STABILIZED BY ONE OR MORE OF THE FOLLOWING METHODS:
- SPRAYING DISTURBED AREAS WITH A TACKIFIER VIA HYDROSEED
 - TRACKING STRAW PERPENDICULAR TO SLOPES
 - INSTALLING A LIGHT-WEIGHT, TEMPORARY EROSION CONTROL BLANKET

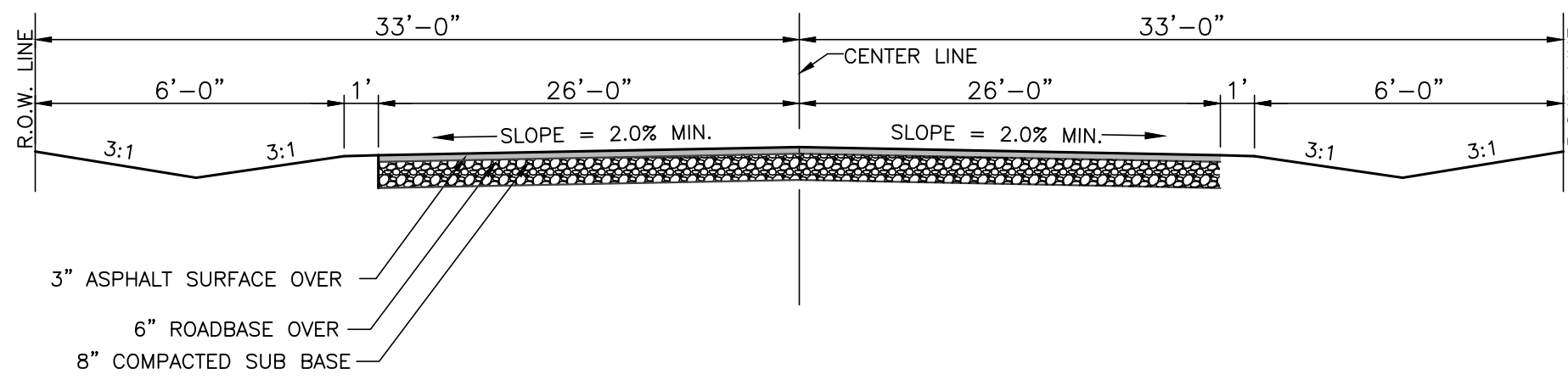

Street Section (66' R.O.W.)
SCALE: NONE

*1. THESE PAVEMENT THICKNESS SHALL BE CONSIDERED AS MINIMUMS AND MAY BE INCREASED BY THE CITY ENGINEER WHEN THE SUBGRADE C.B.R. IS LESS THAN 10 OR WHEN A GREATER DEPTH IS NECESSARY TO PROVIDE SUFFICIENT STABILITY. DEVELOPER MAY SUBMIT AN ALTERNATIVE PAVEMENT DESIGN BASED ON A SOILS ANALYSIS FOR APPROVAL BY THE CITY ENGINEER.

Legend

- SW LAT — = PROPOSED SECONDARY WATER LATERAL
- LD LAT — = PROPOSED LAND DRAIN LATERAL
- W LAT — = PROPOSED WATER LATERAL
- SS LAT — = PROPOSED SEWER LATERAL
- W/B — = PROPOSED CULINARY WATER LINE
- EX.W — = EXISTING CULINARY WATER LINE
- SW/B — = PROPOSED SECONDARY WATER LINE
- EX.SW — = EXISTING SECONDARY WATER LINE
- SS/B — = PROPOSED SANITARY SEWER LINE
- EX.SS — = EXISTING SANITARY SEWER LINE
- SD/15 — = PROPOSED STORM DRAIN LINE
- EX.SD — = EXISTING STORM DRAIN LINE
- LD/B — = PROPOSED LAND DRAIN LINE
- EX.LD — = EXISTING LAND DRAIN LINE
- IRR/18 — = PROPOSED IRRIGATION LINE
- EX.IRR — = EXISTING IRRIGATION LINE
- X — X — X — = FENCE LINE
- — — — — = DRAINAGE SWALE
- OHP — = OVERHEAD POWER LINE
- = PROPOSED FIRE HYDRANT
- = EXISTING FIRE HYDRANT
- = PROPOSED MANHOLE
- = EXISTING MANHOLE
- = PROPOSED SEWER CLEAN-OUT
- ⌘ = PROPOSED GATE VALVE
- ⌘ = EXISTING GATE VALVE
- ⌘ = PLUG & BLOCK
- ⊕ = AIR VAC ASSEMBLY
- = DUAL SECONDARY METER
- = PROPOSED WATER METER
- = EXISTING WATER METER
- = PROPOSED CATCH BASIN
- = EXISTING CATCH BASIN
- ⊕ = PLUG W/ 2" BLOW-OFF
- = STREET LIGHT
- ⊕ = SIGN
- ⊕ = POWER POLE
- BFE = BASEMENT FLOOR ELEVATION
- BLDG = BUILDING
- BOS = BOTTOM OF STAIRS
- BOW = BOTTOM OF WALL
- BP = BEGINNING POINT
- C&G = CURB & GUTTER
- CB = CATCH BASIN
- CF = CUBIC FEET
- CFS = CUBIC FEET PER SECOND
- EP = ENDING POINT
- FF = FINISH FLOOR
- FFE = FINISH FLOOR ELEVATION
- FG = FINISHED GRADE
- FH = FIRE HYDRANT
- FL = FLOW LINE
- GB = GRADE BREAK
- INV = INVERT
- LF = LINEAR FEET
- NG = NATURAL GRADE
- PC = POINT OF CURVATURE
- PP = POWER/UTILITY POLE
- PRC = POINT OF RETURN CURVATURE
- PT = POINT OF TANGENCY
- PUE = PUBLIC UTILITY EASEMENT
- RCP = REINFORCED CONCRETE PIPE
- RIM = RIM OF MANHOLE
- ROW = RIGHT-OF-WAY
- SD = STORM DRAIN
- SS = SANITARY SEWER
- TBC = TOP BACK OF CURB
- TOA = TOP OF ASPHALT
- TOC = TOP OF CONCRETE
- TOFF = TOP OF FINISHED FLOOR
- TOS = TOP OF STAIRS
- TOW = TOP OF WALL
- TSW = TOP OF SIDEWALK
- W = CULINARY WATER
- WM = WATER METER
- = EXISTING ASPHALT PAVEMENT
- = PROPOSED ASPHALT PAVEMENT
- = PROPOSED CONCRETE
- = PROPOSED GRAVEL
- 4800 = EXISTING CONTOUR GRADE
- 4800 = PROPOSED CONTOUR GRADE

Reeve & Associates, Inc.
 5160 SOUTH 1500 WEST, RIVERDALE, UTAH 84405
 TEL: (801) 621-3100 www.reeve-assoc.com

LAND SURVEYORS • CIVIL ENGINEERS • LAND SURVEYING
 TRAFFIC ENGINEERS • STRUCTURAL ENGINEERS • LANDSCAPE ARCHITECTS

REVISIONS	DATE	DESCRIPTION
	2021.12.06	NF Added 12" Water
	2022.01.18	NF Added Pump Det.
	2022.04.01	NF Taylor West Weber
	2022.04.14	NF Utility Location
	2022.05.03	NF Relocated Irrigation
	2022.05.03	NF Weber County Contm

TC Gailey Subdivision
 WEBER COUNTY, UTAH

Notes/Legend

Project Info.

Engineer: JEREMY A. DRAPER, P.E.
 Drafter: N. FICKLIN
 Begin Date: NOVEMBER, 2021
 Name: TC GAILEY SUBDIVISION
 Number: 7713-01



Landscape Irrigation Calculations Powers Property

7/19/2021
7713-01

The following calculations are used to determine the amount of water needed for landscape irrigation and the volume required for storage. Calculations are based on historic evapotranspiration rates (Eto) in the Salt Lake City Area and the peak demand for lawn irrigation. Peak demand for irrigation occurs in the month of July. The following table is based on a 7 month growing season from April to October. The assumption is made that each lot is entirely landscaped with lawn.

Landscape Irrigation Requirement Calculations								
Monthly Water Allowance (gallons) = ETO x 1.0 x 0.62 x Area								
353,278								
Month	April	May	June	July(Peak)	August	Sept	Oct	
ETO (inches)	3.4	4.6	5.4	6.2	5.6	3.7	2.3	
Gallons Monthly	735,949	1,005,359	1,182,775	1,360,191	1,226,581	814,800	503,774	
Gallons Weekly	183,987	251,340	295,694	340,048	306,645	203,700	125,944	
Gallons Daily	24,532	33,512	38,154	43,877	39,567	27,160	16,792	
Gallons Annually	6,829,429							

Days Between Receiving Water: 7 Days
Required Storage Volume: 45,455 ft³

STAGE STORAGE TABLE						
ELEV.	AREA (sq. ft.)	DEPT H (ft)	AVG END INC. VOL. (cu. ft.)	AVG END TOTAL VOL. (cu. ft.)	CONIC INC. VOL. (cu. ft.)	CONIC TOTAL VOL. (cu. ft.)
4,247.10	0.00	N/A	0.00	0.00	N/A	0.00
4,248.00	4,448.92	0.90	1999.79	1334.47	1334.47	1334.47
4,249.00	14,891.12	1.00	9670.02	11669.81	9159.80	10494.27
4,250.00	26,000.57	1.00	20445.84	32115.65	20189.50	30683.77
4,250.60	30,112.48	0.60	16833.91	48949.57	16818.83	47502.60
4,251.00	31,834.03	0.40	12389.30	61338.87	12387.71	59890.31
4,251.60	311.79	0.60	9643.75	70982.62	7059.26	66949.57

BASIN NOTES:
TOP/BERM = 4251.60
HIGH WATER = 4250.60
BOTTOM INV IN = 4250.60
BOTTOM INV OUT = 4247.10
BOTTOM SLOPE = 1.0%
SIDE SLOPE = 3:1

Construction Notes:

1. ALL CONSTRUCTION IS TO CONFORM TO THE STANDARD DRAWINGS AND SPECIFICATIONS OF TAYLOR WEST WEBER WATER DISTRICT.

CULINARY WATER

W/LAT - 1" POLY PIPE, 1" METER
FIRE HYD. - 6" PVC DR-18 C-900
W/12 - 12" C-900 PVC

STORM DRAIN

SD/15 - 15" RCP CLASS III STORM DRAIN

SECONDARY WATER

SW/3 - 3" SCH80 OR HDPE PER ASTM D-2241 (PURPLE PIPE)
SW/2 - 2" SCH80 OR HDPE PER ASTM D-2241 (PURPLE PIPE)

IRRIGATION

IRR/12 - 12" RCP CLASS III IRRIGATION

NOTE:

- SAWCUT MIN. 2" INTO EXISTING ASPHALT INSIDE FROM OUTER EDGE FOR TACK SEAL OF NEW ASPHALT ON ROAD WIDENING.
- CONTRACTOR TO VERIFY 2% MINIMUM-5% MAX SLOPE FROM EDGE OF ASPHALT TO EDGE OF PAVEMENT UNLESS SPECIFIED DIFFERENT ON PLAN.
- SLOPE SHALL FLOW TOWARDS EDGE OF PAVEMENT UNLESS SPECIFIED DIFFERENT ON PLAN.
- ASPHALT SEAL COAT FOR ASPHALT PRESERVATION TO BE COORDINATED WITH WEBER COUNTY.
- CULINARY WATER SERVICE LATERALS FOR EACH LOT TO CONNECT TO EXISTING MAIN LINE. (FIELD VERIFY DEPTH & LOCATION)

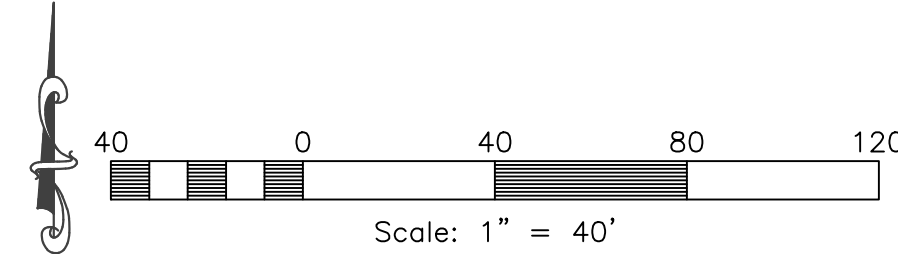
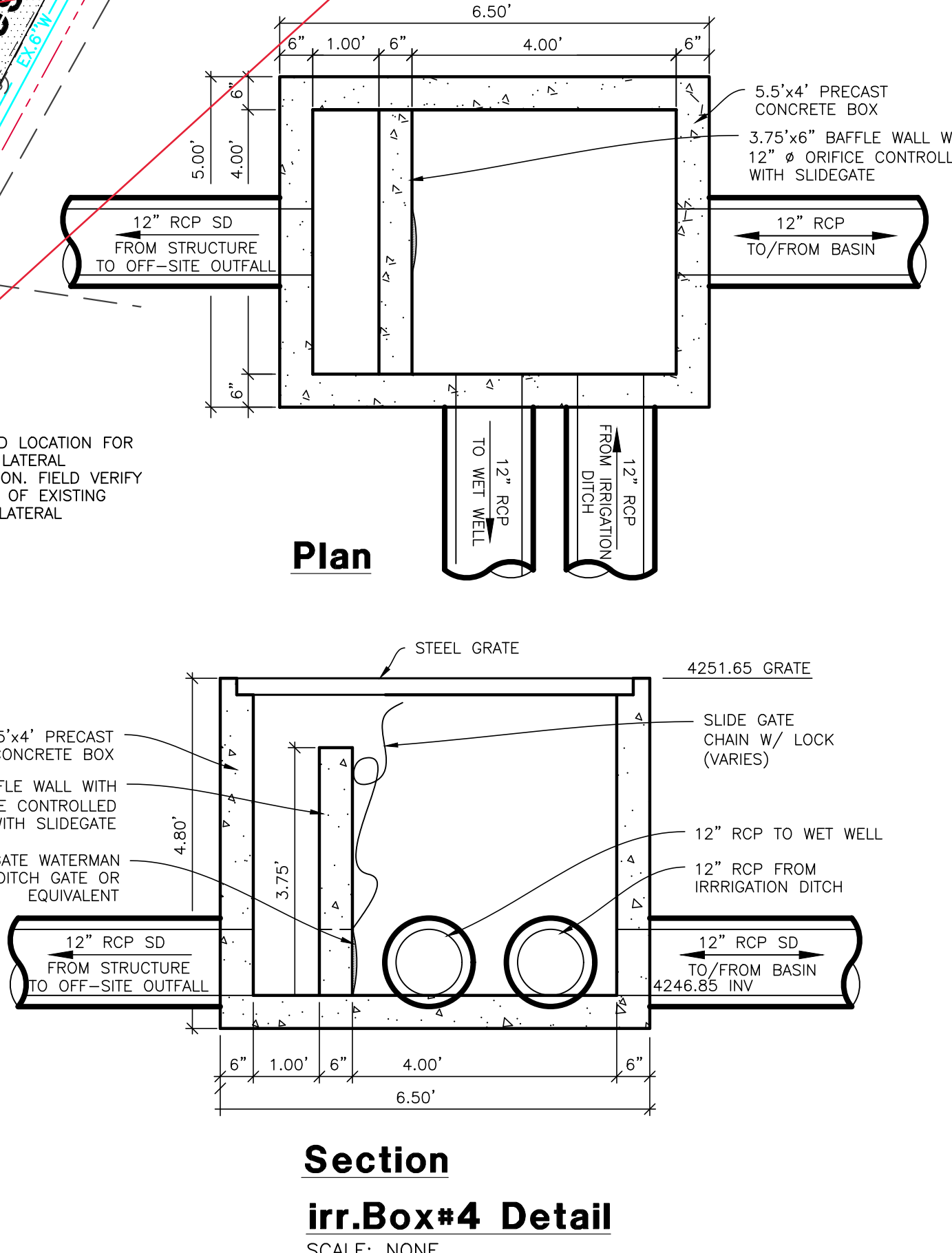
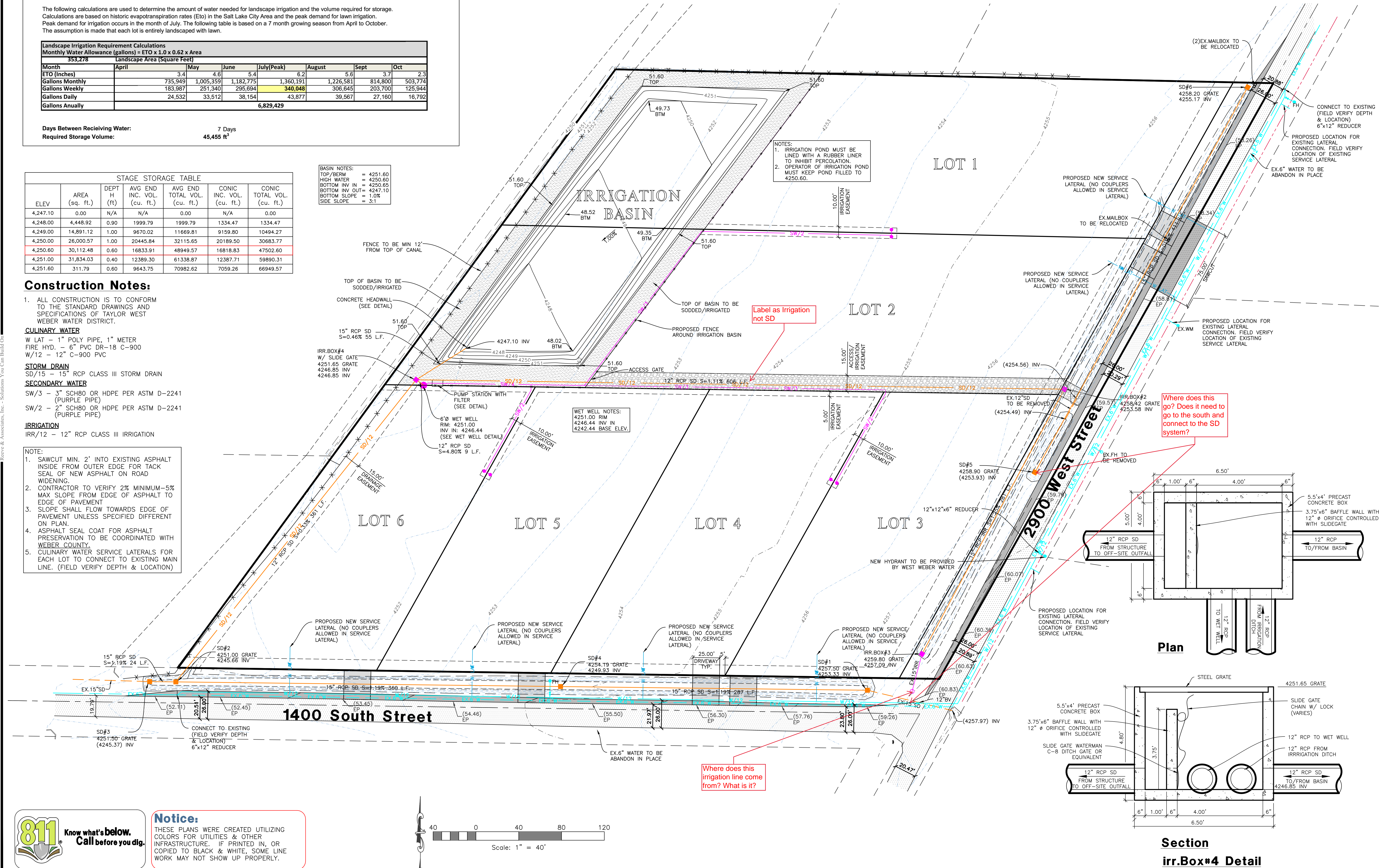

Notice:
THESE PLANS WERE CREATED UTILIZING COLORS FOR UTILITIES & OTHER INFRASTRUCTURE. IF PRINTED IN, OR COPIED TO BLACK & WHITE, SOME LINE WORK MAY NOT SHOW UP PROPERLY.

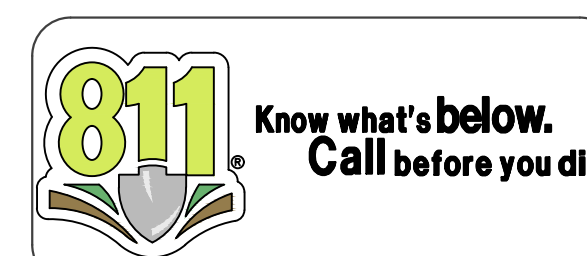

Reeve & Associates, Inc.
5160 SOUTH 1500 WEST, RIVERDALE, UTAH 84405
TEL: (801) 621-3100 www.reeve-assoc.com

RA

LAND SURVEYORS • CIVIL ENGINEERS • LAND SURVEYORS
TRAFFIC ENGINEERS • STRUCTURAL ENGINEERS • LANDSCAPE ARCHITECTS

REVISIONS	DATE	DESCRIPTION
	2021.12.06	NF Added 12" Water
	2022.01.18	NF Added Pump Det.
	2022.04.01	NF Taylor West Weber Utility Location
	2022.04.14	NF Relocated Irrigation
	2022.05.03	NF Weber County Contm

TC Gailey Subdivision
WEBER COUNTY, UTAH

Grading & Utility Plan

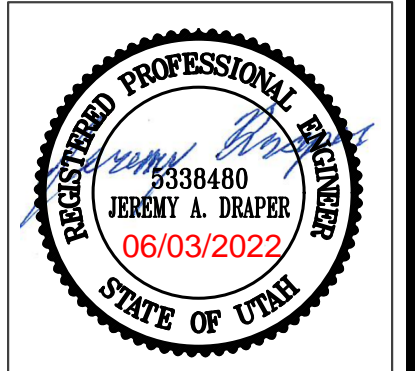

Project Info.
Engineer: JEREMY A. DRAPER, P.E.
 Drafter: N. FICKLIN
Begin Date: NOVEMBER, 2021
Name: TC GAILEY SUBDIVISION
Number: 7713-01

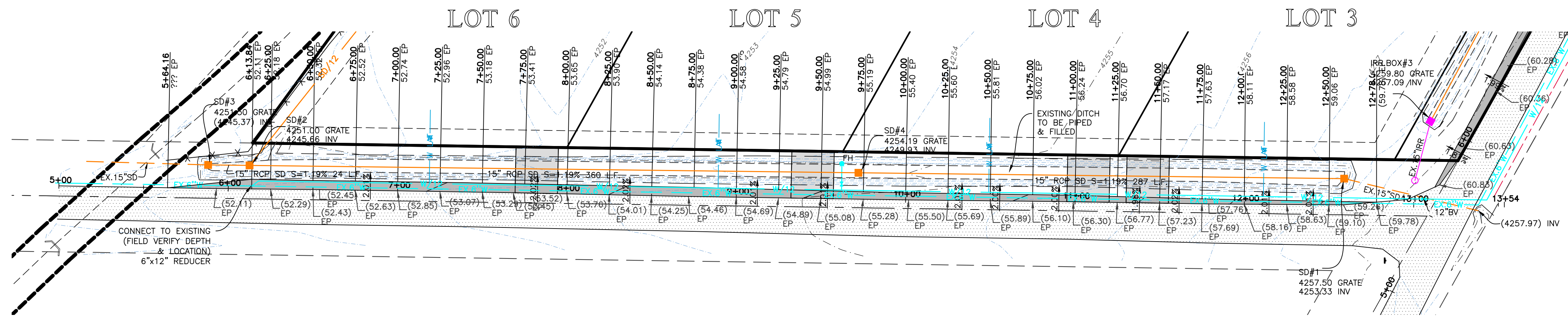

1400 South Street

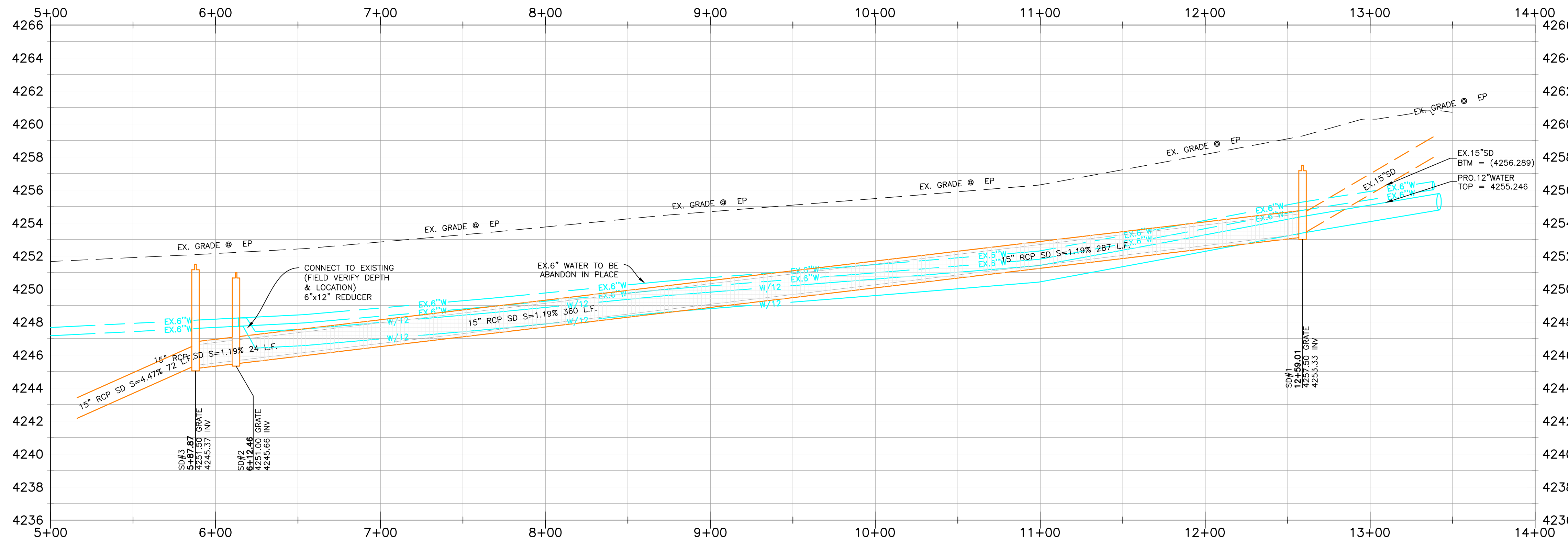
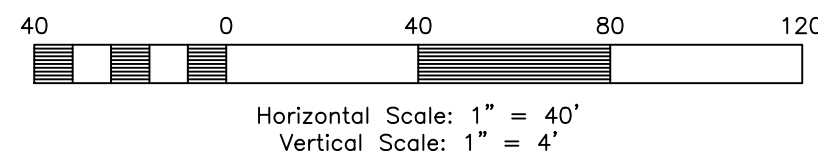

Construction Notes:

- ALL CONSTRUCTION IS TO CONFORM TO THE STANDARD DRAWINGS AND SPECIFICATIONS OF TAYLOR WEST WEBER WATER DISTRICT.
- CULINARY WATER**
W/LAT - 1" POLY PIPE, 1" METER
FIRE HYD. - 6" PVC DR-18 C-900
W/12 - 12" C-900 PVC
- STORM DRAIN**
SD/15 - 15" RCP CLASS III STORM DRAIN
- SECONDARY WATER**
SW/3 - 3" SCH80 OR HDPE PER ASTM D-2241 (PURPLE PIPE)
SW/2 - 2" SCH80 OR HDPE PER ASTM D-2241 (PURPLE PIPE)
- IRRIGATION**
IRR/12 - 12" RCP CLASS III IRRIGATION

- NOTE:**
- SAWCUT MIN. 2' INTO EXISTING ASPHALT INSIDE FROM OUTER EDGE FOR TACK SEAL OF NEW ASPHALT ON ROAD WIDENING.
 - CONTRACTOR TO VERIFY 2% MINIMUM-5% MAX SLOPE FROM EDGE OF ASPHALT TO EDGE OF PAVEMENT
 - SLOPE SHALL FLOW TOWARDS EDGE OF PAVEMENT UNLESS SPECIFIED DIFFERENT ON PLAN.
 - ASPHALT SEAL COAT FOR ASPHALT PRESERVATION TO BE COORDINATED WITH WEBER COUNTY.
 - CULINARY WATER SERVICE LATERALS FOR EACH LOT TO CONNECT TO EXISTING MAIN LINE. (FIELD VERIFY DEPTH & LOCATION)

Reeve & Associates, Inc.
 5160 SOUTH 1500 WEST, RIVERDALE, UTAH 84405
 TEL: (801) 621-3100 www.reeve-associates.com
 LAND PLANNERS • CIVIL ENGINEERS • LAND SURVEYORS
 TRAFFIC ENGINEERS • STRUCTURAL ENGINEERS • LANDSCAPE ARCHITECTS

REVISIONS	DATE	DESCRIPTION
	2021.12.06	NF Added 12" Water
	2022.01.18	PB Added Pump Det.
	2022.04.01	NF Taylor West Weber
	2022.04.14	NF Utility Location
	2022.05.03	NF Relocated Irrigation
	2022.05.03	NF Weber County Contm

TC Gailey Subdivision
 WEBER COUNTY, UTAH
1400 South Street

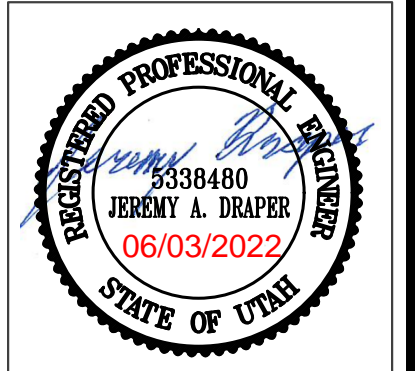

Project Info.

Engineer: JEREMY A. DRAPER, P.E.
 Drafter: N. FICKLIN
 Begin Date: NOVEMBER, 2021
 Name: TC GAILEY SUBDIVISION
 Number: 7713-01

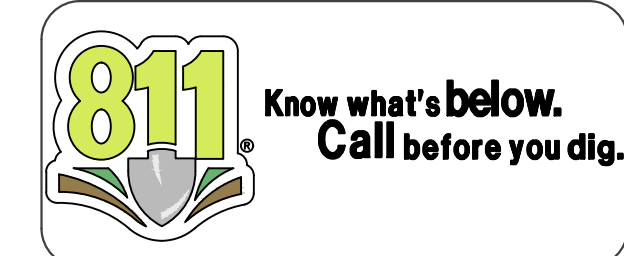

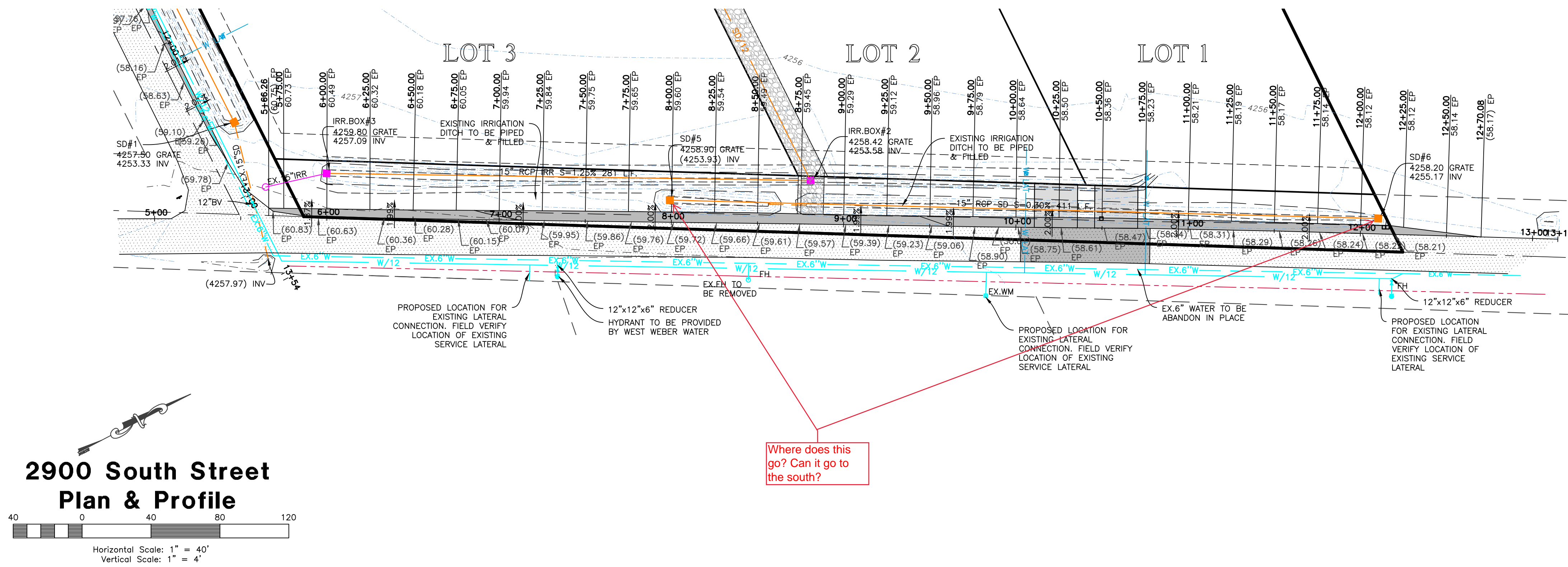

Where does this go? Can it go to the south?

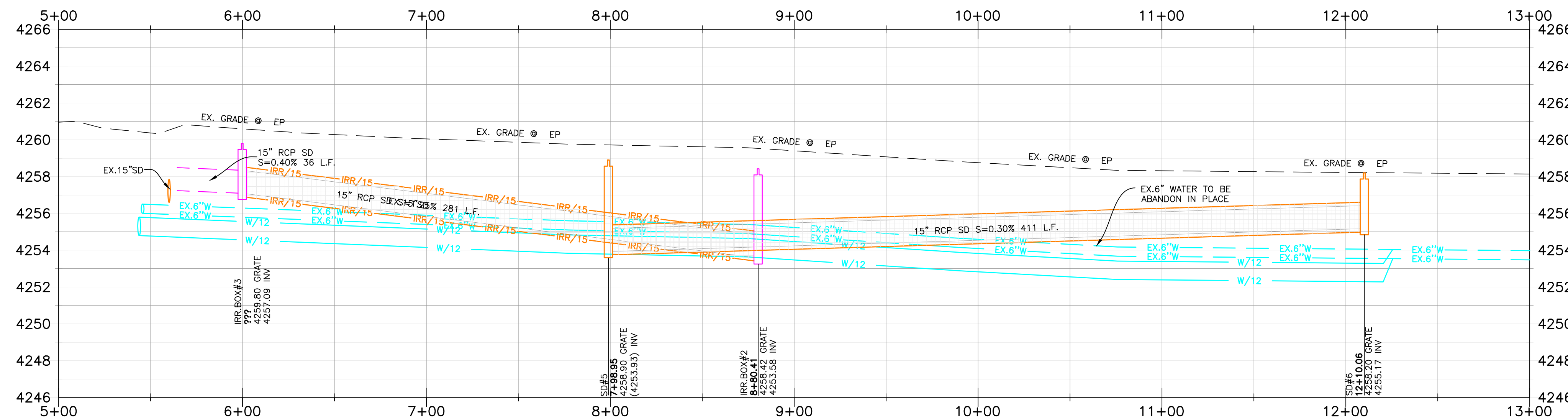

Construction Notes:

- ALL CONSTRUCTION IS TO CONFORM TO THE STANDARD DRAWINGS AND SPECIFICATIONS OF TAYLOR WEST WEBER WATER DISTRICT.
- CULINARY WATER**
W/LAT - 1" POLY PIPE, 1" METER
FIRE HYD. - 6" PVC DR-18 C-900
W/12 - 12" C-900 PVC
- STORM DRAIN**
SD/15 - 15" RCP CLASS III STORM DRAIN
- SECONDARY WATER**
SW/3 - 3" SCH80 OR HDPE PER ASTM D-2241 (PURPLE PIPE)
SW/2 - 2" SCH80 OR HDPE PER ASTM D-2241 (PURPLE PIPE)
- IRRIGATION**
IRR/12 - 12" RCP CLASS III IRRIGATION

- NOTE:
- SAWCUT MIN. 2' INTO EXISTING ASPHALT INSIDE FROM OUTER EDGE FOR TACK SEAL OF NEW ASPHALT ON ROAD WIDENING.
 - CONTRACTOR TO VERIFY 2% MINIMUM-5% MAX SLOPE FROM EDGE OF ASPHALT TO EDGE OF PAVEMENT
 - SLOPE SHALL FLOW TOWARDS EDGE OF PAVEMENT UNLESS SPECIFIED DIFFERENT ON PLAN.
 - ASPHALT SEAL COAT FOR ASPHALT PRESERVATION TO BE COORDINATED WITH WEBER COUNTY.
 - CULINARY WATER SERVICE LATERALS FOR EACH LOT TO CONNECT TO EXISTING MAIN LINE. (FIELD VERIFY DEPTH & LOCATION)

Reeve & Associates, Inc.
 5160 SOUTH 1500 WEST, RIVERDALE, UTAH 84405
 LAND SURVEYORS • CIVIL ENGINEERS • LAND SURVEYING
 TRAFFIC ENGINEERS • STRUCTURAL ENGINEERS • LANDSCAPE ARCHITECTS

REVISIONS	DATE	DESCRIPTION
	2021.12.06	NF Added 12" Water
	2022.01.18	PB Added Pump Det.
	2022.04.01	NF Taylor West Weber
	2022.04.14	NF Utility Location
	2022.05.03	NF Relocated Irrigation
	2022.05.03	NF Weber County Contm

TC Gailey Subdivision
 WEBER COUNTY, UTAH
2900 West Street



Project Info.

Engineer: JEREMY A. DRAPER, P.E.
 Drafter: N. FICKLIN
 Begin Date: NOVEMBER, 2021
 Name: TC GAILEY SUBDIVISION
 Number: 7713-01



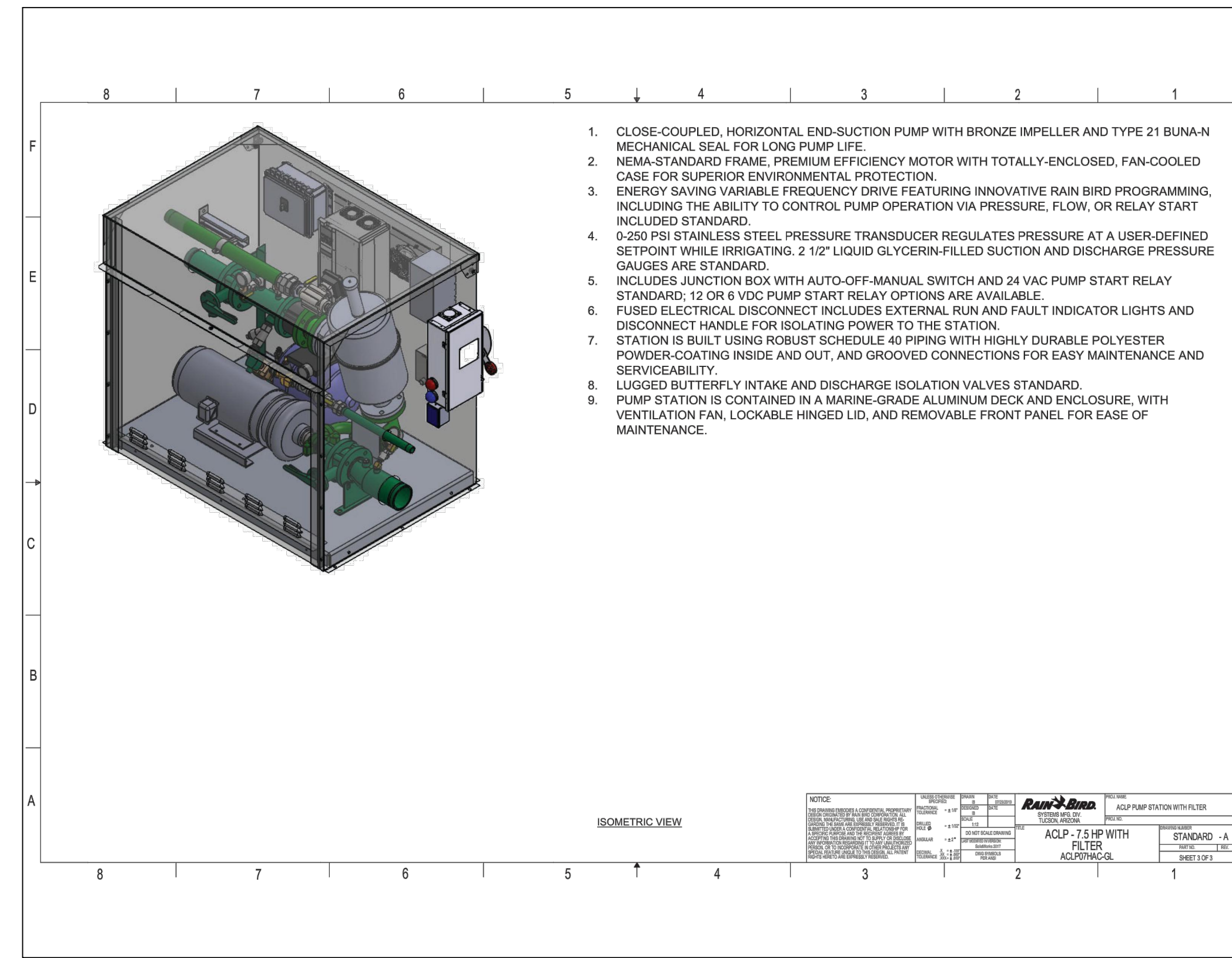
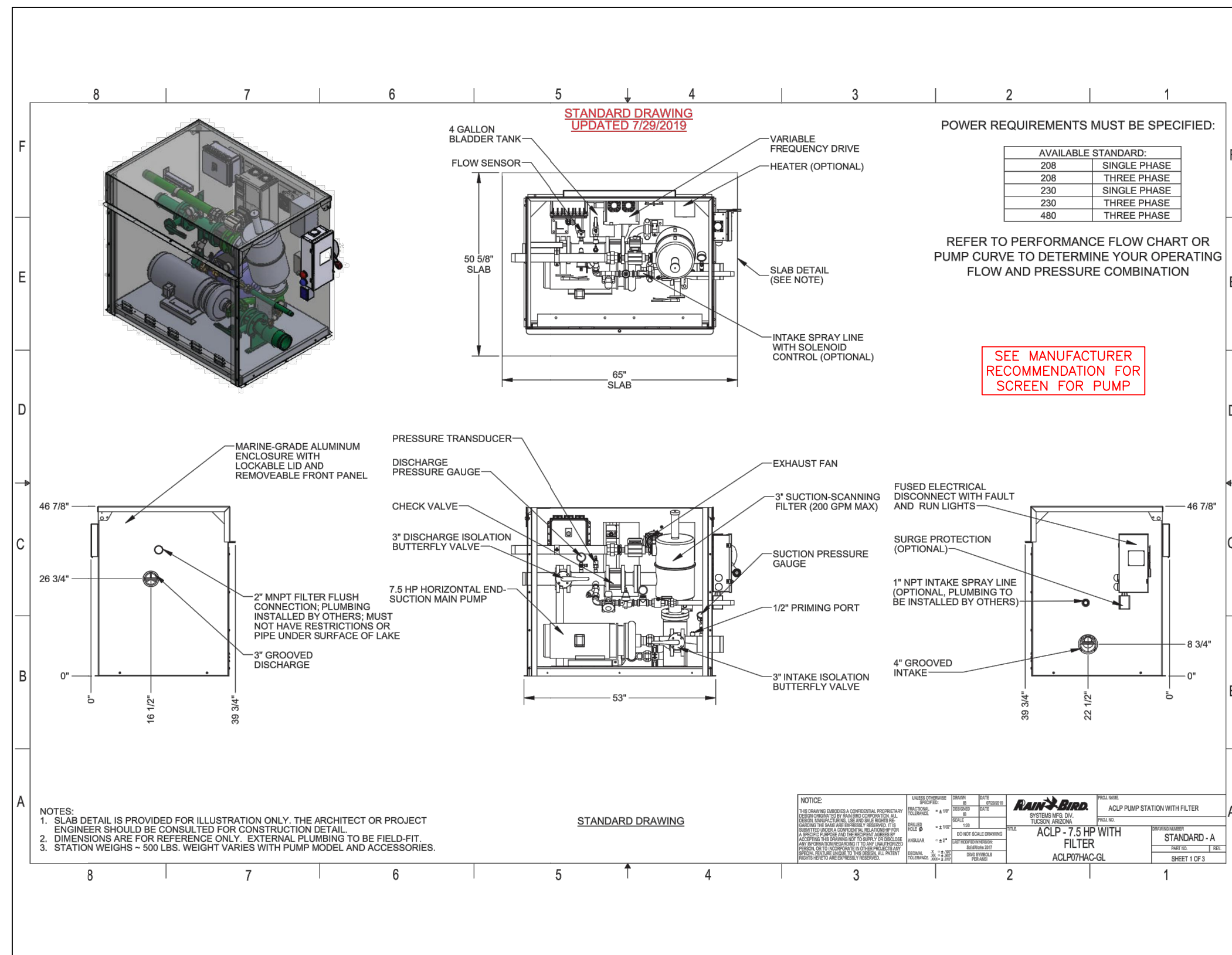

Pump Sizing Calculations
TC Gailey
7713-01
4/13/2022 JRL

The calculations are as follows:

# OF LOTS	6
ZONES PER LOT	1.5
FLOW PER ZONE	33 gpm
GOAL PRESSURE	50 psi = 115.5 ft of pressure head
TOTAL LENGTH	980.01 ft
ROUGHNESS COEFFICIENT	150
REQUIRED FLOW	66 gpm (3 Lots running 1 zone each)
PROVIDED FLOW	66.00 gpm
INSIDE HYDRAULIC DIAMETER	3 in
HEAD LOSS PER 100 FT OF PIPE	0.2083(100/c) ^{1.852} q ^{1.852} /dh ^{4.8655}
	1.10 ft
	10.77 ft of head loss
WET WELL OUTLET EL.	4246.77 ft
HIGH POINT EL.	4251.21 ft
	4.44 ft of elevation head
FILTER HEAD LOSS	5 ft (Estimated)
Total Dynamic Head	135.71 ft = 58.7 psi
Velocity:	3.0 ft/s

Rain Bird ACIP - 7.5 HP Pump Station

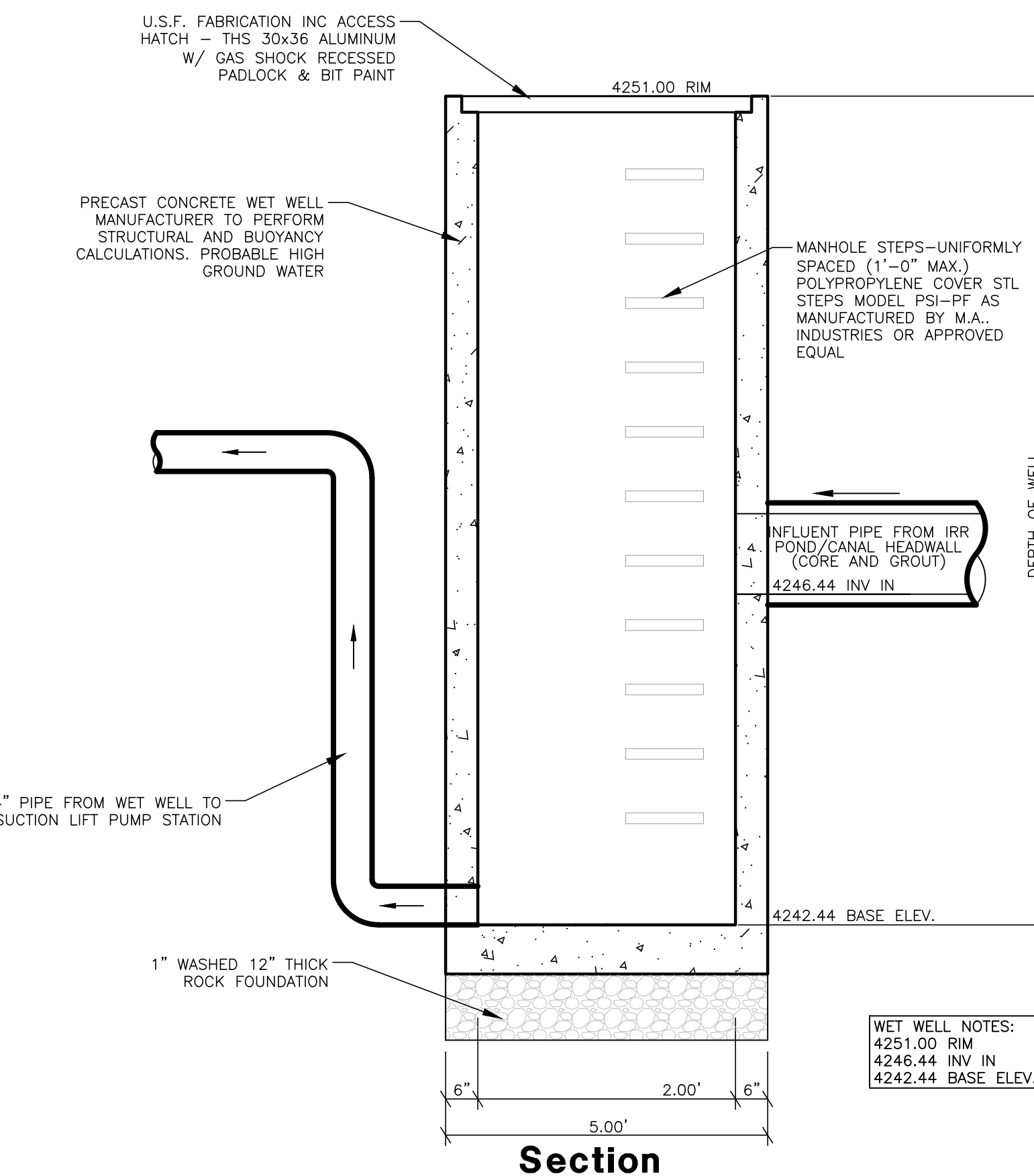
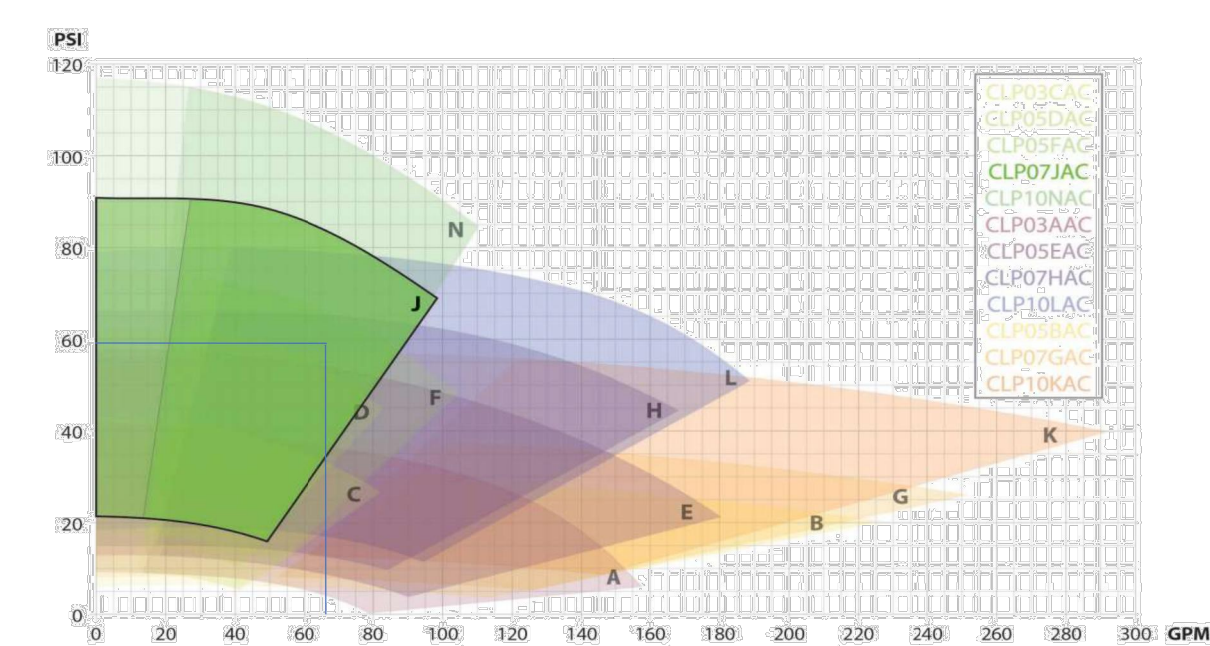

Section

Wet Well Details
SCALE: NONE

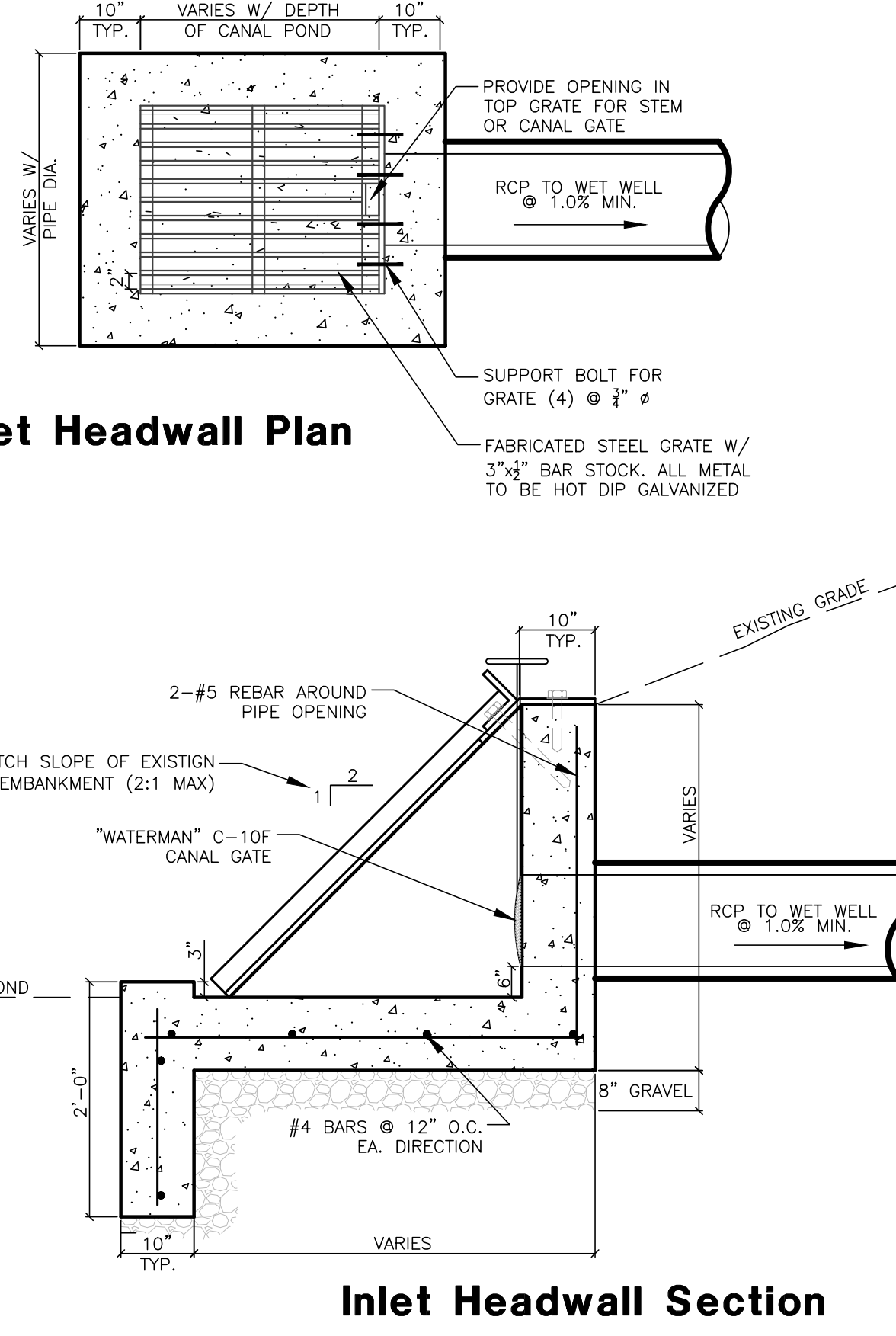

Inlet Headwall Section

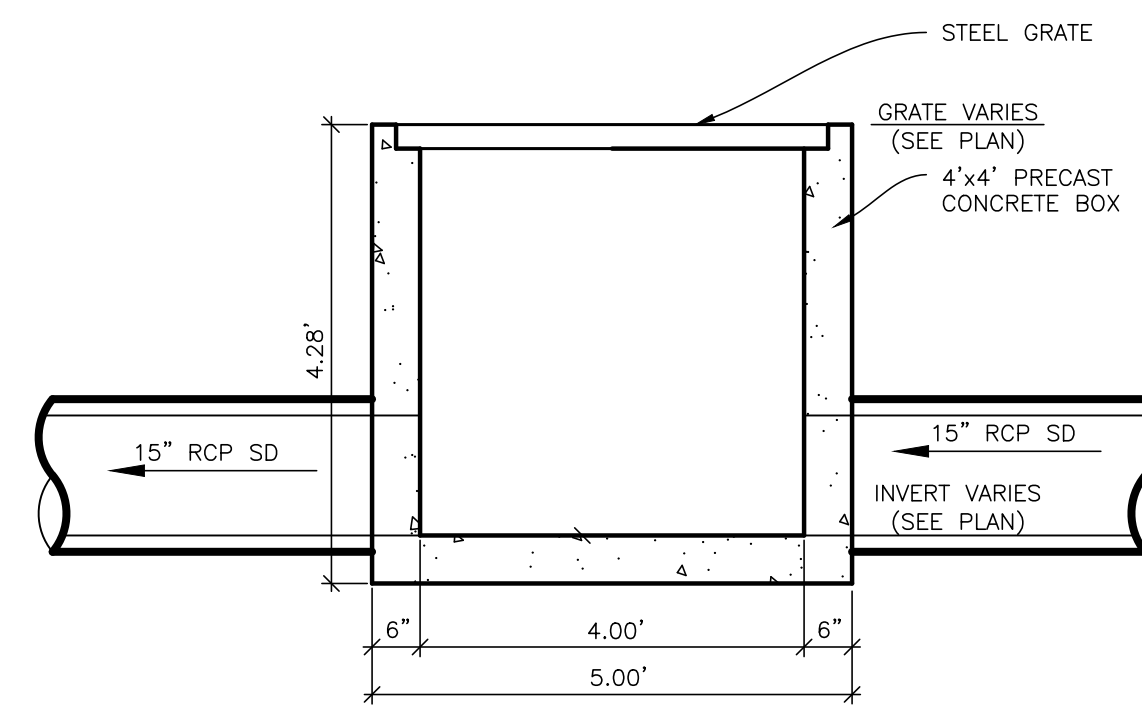

Section

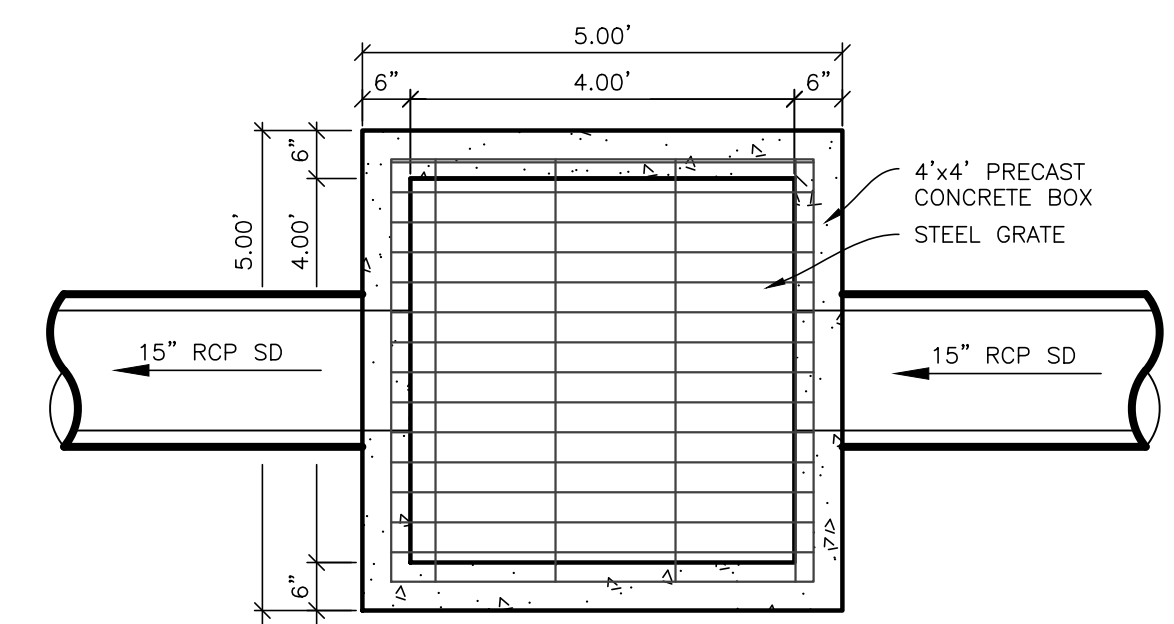

Plan

4'x4' Typical Storm Drain Detail
SCALE: NONE

Reeve & Associates, Inc.
5160 SOUTH 1500 WEST, RIVERDALE, UTAH 84405
TEL: (801) 621-3100 www.reeve-assoc.com

LAND PLANNERS • CIVIL ENGINEERS • LAND SURVEYORS
TRAFFIC ENGINEERS • STRUCTURAL ENGINEERS • GEOTECHNICAL ENGINEERS

REVISIONS

DATE	DESCRIPTION
2021.12.06	NF Added 1.2" Water
2022.01.18	PB Added Pump Det.
2022.04.01	NF Taylor West Weber
2022.04.14	NF Utility Location
2022.05.03	NF Relocated Irrigation
2022.05.03	NF Weber County Contm

TC Gailey Subdivision
WEBER COUNTY, UTAH

Details



Project Info.
Engineer: JEREMY A. DRAPER, P.E.
Drafter: N. FICKLIN
Begin Date: NOVEMBER, 2021
Name: TC GAILEY SUBDIVISION
Number: 7713-01

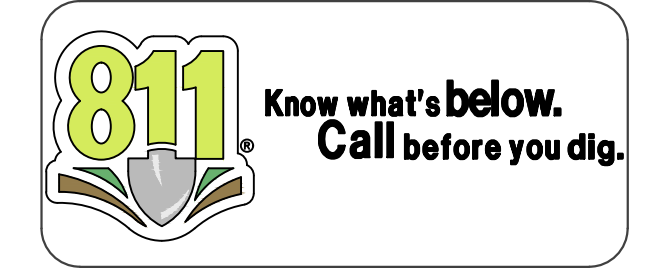

TC GAILEY SUBDIVISION

Storm Water Pollution Prevention Plan Exhibit

WEBER COUNTY, UTAH
MAY, 2022

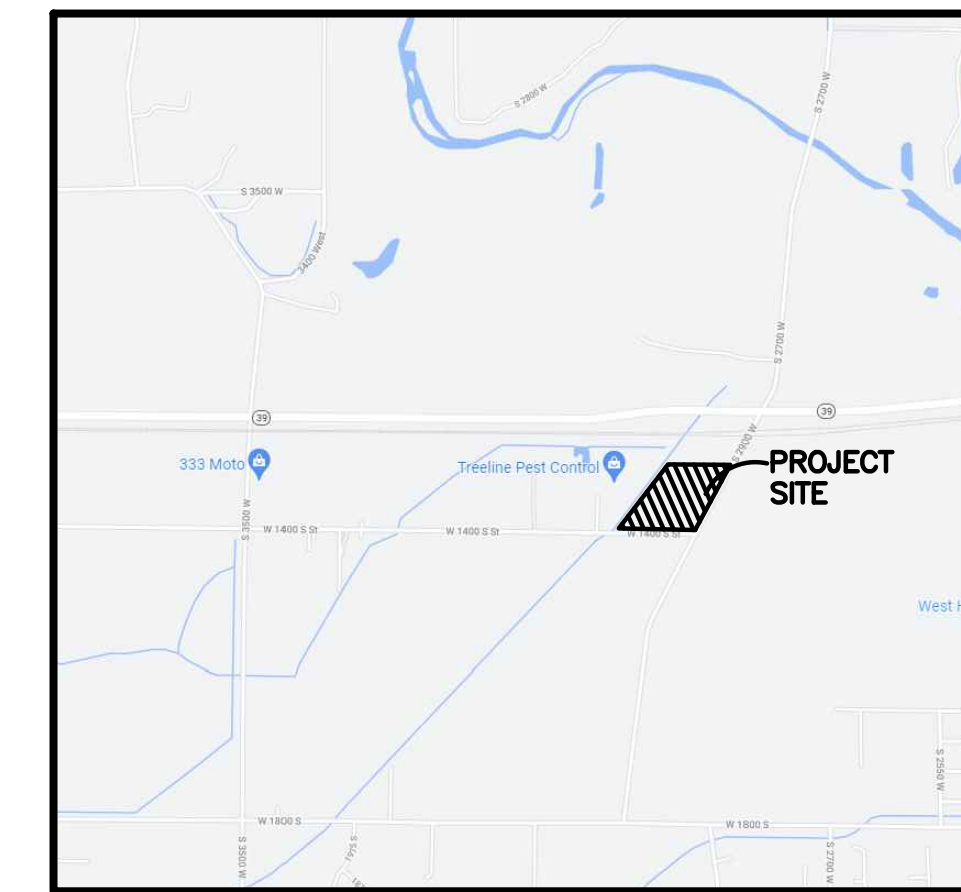

Vicinity Map
NOT TO SCALE

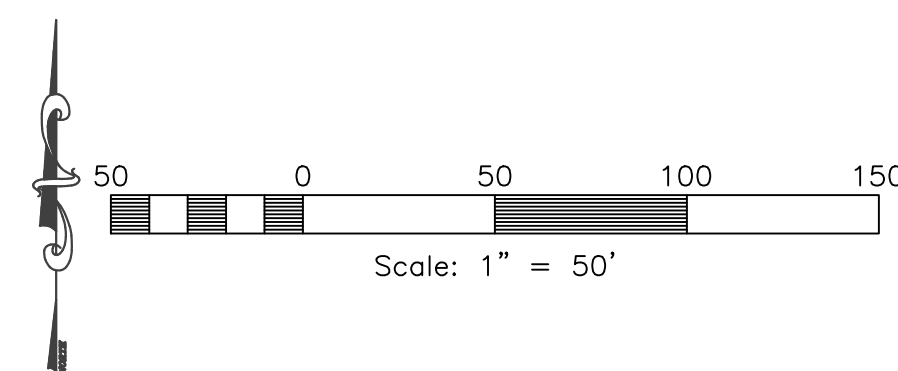
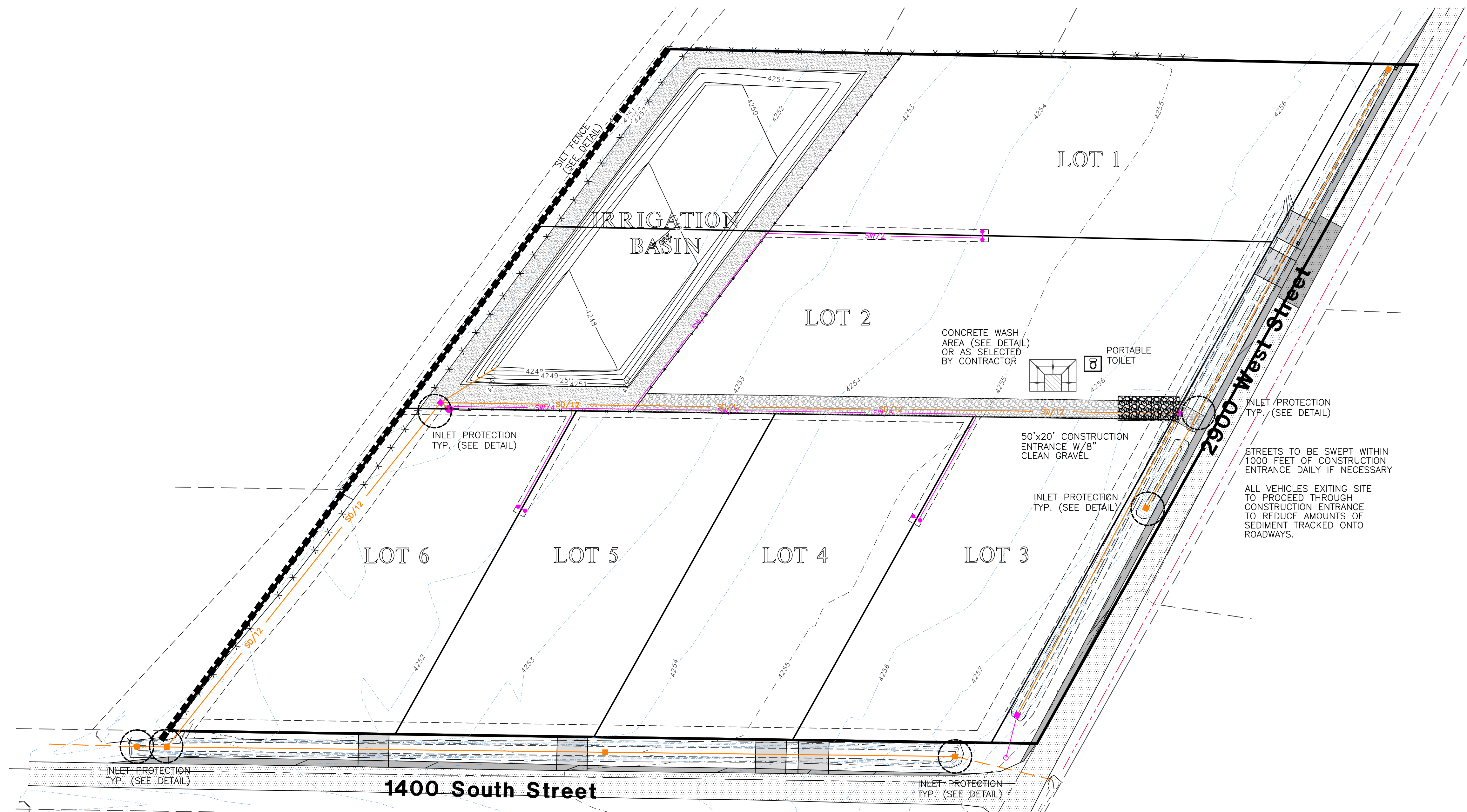

Construction Activity Schedule	
- PROJECT LOCATION.....	WEBER COUNTY, (UTAH)
- PROJECT BEGINNING DATE.....	MAY, 2022
- BMP'S DEPLOYMENT DATE.....	MAY, 2022
- STORM WATER MANAGEMENT CONTACT / INSPECTOR.....	JED SCHENCK (801) 499-9774
- SPECIFIC CONSTRUCTION SCHEDULE INCLUDING BMP CONSTRUCTION SCHEDULE TO BE INCLUDED WITH SWPPP BY OWNER/DEVELOPER	

Reeve & Associates, Inc.
 5160 SOUTH 1500 WEST, RIVERDALE, UTAH 84405
 TEL: (801) 621-3100 www.reeve-assoc.com

RA

LAND PLANNERS • CIVIL ENGINEERS • LAND SURVEYORS
 TRAFFIC ENGINEERS • STRUCTURAL ENGINEERS • GEOTECHNICAL ENGINEERS

DATE	DESCRIPTION
2021.12.06	NF Added 12" Water
2022.01.18	PB Added Pump Det.
2022.04.01	NF Taylor West Weber
2022.04.14	NF Utility Location
2022.05.03	NF Relocated Irrigation
2022.05.03	NF Weber County Contm

TC Gailey Subdivision
 WEBER COUNTY, UTAH

Storm Water Pollution Prevention Plan Exhibit



Project Info.	
Engineer:	JEREMY A. DRAPER, P.E.
Drafter:	N. FICKLIN
Begin Date:	NOVEMBER, 2021
Name:	TC GAILEY SUBDIVISION
Number:	7713-01

Reeve & Associates, Inc. - Solutions You Can Build On

Reeve & Associates, Inc. - Solutions You Can Build On

Notes:

- Describe all BMP's to protect storm water inlets:
All storm water inlets to be protected by straw wattle barriers, or gravel bags (see detail).
- Describe BMP's to eliminate/reduce contamination of storm water from:
 - Equipment / building / concrete wash areas:
To be performed in designated areas only and surrounded with silt fence barriers.
 - Soil contaminated by soil amendments:
If any contaminants are found or generated, contact environmental engineer and contacts listed.
 - Areas of contaminated soil:
If any contaminants are found or generated, contact environmental engineer and contacts listed.
 - Fueling area:
To be performed in designated areas only and surrounded with silt fence.
 - Vehicle maintenance areas:
To be performed in designated areas only and surrounded with silt fence.
 - Vehicle parking areas:
To be performed in designated areas only and surrounded with silt fence.
 - Equipment storage areas:
To be performed in designated areas only and surrounded with silt fence.
 - Materials storage areas:
To be performed in designated areas only and surrounded with silt fence.
 - Waste containment areas:
To be performed in designated areas only and surrounded with silt fence.
 - Service areas:
To be performed in designated areas only and surrounded with silt fence.
- BMP's for wind erosion:
Stockpiles and site as needed to be watered regularly to eliminate / control wind erosion
- Construction Vehicles and Equipment:
 - Maintenance
 - Maintain all construction equipment to prevent oil or other fluid leaks.
 - Keep vehicles and equipment clean; prevent excessive build-up of oil and grease.
 - Regularly inspect on-site vehicles and equipment for leaks, and repair immediately.
 - Check incoming vehicles and equipment (including delivery trucks, and employee and subcontractor vehicles) for leaking oil and fluids. Do not allow leaking vehicles or equipment on-site.
 - Segregate and recycle wastes, such as greases, used oil or oil filters, antifreeze, cleaning solutions, automotive batteries, hydraulic, and transmission fluids.
 - Fueling
 - If fueling must occur on-site, use designated areas away from drainage.
 - Locate on-site fuel storage tanks within a bermed area designed to hold the tank volume.
 - Cover retention area with an impervious material and install in a manner to ensure that any spills will be contained in the retention area. To catch spills or leaks when removing or changing fluids.
 - Use drip pans for any oil or fluid changes.
 - Washing
 - Use as little water as possible to avoid installing erosion and sediment controls for the wash area.
 - If washing must occur on-site, use designated, bermed wash areas to prevent waste water discharge into storm water, creeks, rivers, and other water bodies.
 - Use phosphate-free, biodegradable soaps.
 - Do not permit steam cleaning on-site.
- Spill Prevention and Control
 - Minor Spills:
Minor spills are those which are likely to be controlled by on-site personnel. After contacting local emergency response agencies, the following actions should occur upon discovery of a minor spill:
 - Contain the spread of the spill.
 - If the spill occurs on paved or impermeable surfaces, clean up using "dry" methods (i.e. absorbent materials, cat litter, and / or rags).
 - If the spill occurs in dirt areas, immediately contain the spill by constructing an earth dike. Dig up and properly dispose of contaminated soil.
 - If the spill occurs during rain, cover the impacted area to avoid runoff.
 - Record all steps taken to report and contain spill.
 - Major Spills:
On-site personnel should not attempt to control major spills until the appropriate and qualified emergency response staff have arrived at the site. For spills of federal reportable quantities, also notify the National Response Center at (800) 424-8802. A written report should be sent to all notified authorities. Failure to report major spills can result in significant fines and penalties.
- Post Roadway / Utility Construction
 - Maintain good housekeeping practices.
 - Enclose or cover building material storage areas.
 - Properly store materials such as paints and solvents.
 - Store dry and wet materials under cover, away from drainage areas.
 - Avoid mixing excess amounts of fresh concrete or cement on-site.
 - Perform washout of concrete trucks offsite or in designated areas only.
 - Do not wash out concrete trucks into storm drains, open ditches, streets or streams.
 - Do not place material or debris into streams, gutters or catch basins that stop or reduce the flow of runoff water.
 - All public streets and storm drain facilities shall be maintained free of building materials, mud and debris caused by grading or construction operations. Roads will be swept within 1000' of construction entrance daily, if necessary.
 - Install straw wattle around all inlets contained within the development and all others that receive runoff from the development.
- Erosion Control Plan Notes
 - The contractor will designate an emergency contact that can be reached 24 hours a day 7 days a week. A stand-by crew for emergency work shall be available at all times during potential rain or snow runoff events. Necessary materials shall be available on site and stockpiled at convenient locations to facilitate rapid construction of emergency devices when rain or runoff is eminent.
 - Erosion control devices shown on the plans and approved for the project may not be removed without approval of the engineer of record. If devices are removed, no work may continue that have the potential of erosion without consulting the engineer of record. If deemed necessary erosion control should be reestablished before this work begins.
 - Graded areas adjacent to fill slopes located at the site perimeter must drain away from the top of the slope at the conclusion of each working day. This should be confirmed by survey or other means acceptable to the engineer of record.
 - All silt and debris shall be removed from all devices within 24 hours after each rain or runoff event.
 - Except as otherwise approved by the inspector, all removable protective devices shown shall be in place at the end of each working day and through weekends until removal of the system is approved.
 - All loose soil and debris, which may create a potential hazard to offsite property, shall be removed from the site as directed by the engineer of record of the governing agency.
 - The placement of additional devices to reduce erosion damage within the site is left to the discretion of the engineer of record.
 - Desilting basins may not be removed or made inoperable without the approval of the engineer of record and the governing agency.
 - Erosion control devices will be modified as need as the project progresses and plans of these changes submitted for approval by the engineer of record and the governing agency.
- Conduct a minimum of one inspection of the erosion and sediment controls every two weeks. Maintain documentation on site.
 - Part III.D.4 of general permit UTRC00000 identifies the minimum inspection requirements.
 - Part III.D.4.C identifies the minimum inspection report requirements.
 - Failure to complete and/or document storm water inspections is a violation of part III.D.4 of Utah General Permit UTR 300000.

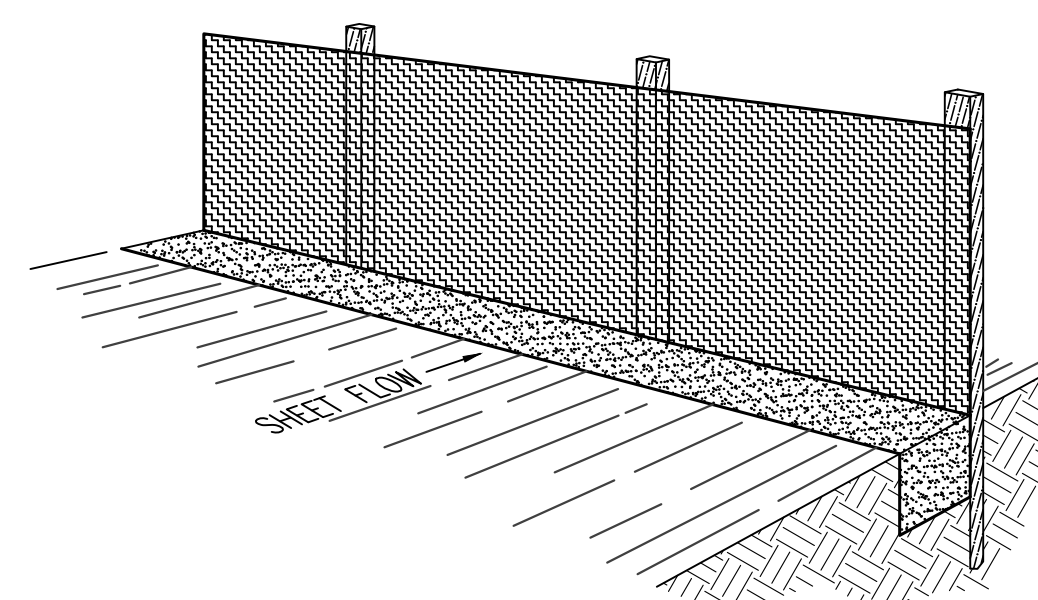

Perspective View

Figure 2

INSTALLATION

The silt fence should be installed prior to major soil disturbances in the drainage area. The fence should be placed across the slope along a line of uniform elevation wherever flow of sediment is anticipated. Table 1 shows generally-recommended maximum slope lengths (slope spacing between fences) at various site grades for most silt fence applications.

Slope Steepness (%)	Max. Slope Length m (ft)
<2%	30.5m (100ft)
2-5%	22.9m (75ft)
5-10%	15.2m (50ft)
10-20%	7.6m (25ft)
>20%	4.5m (15ft)

PREFABRICATED SILT FENCE ROLLS

- Excavate a minimum 15.2cm x 15.2cm (6"x6") trench at the desired location.
- Unroll the silt fence, positioning the post against the downstream wall of the trench.
- Adjacent rolls of silt fence should be joined by nesting the end post of one fence into the other. Before nesting the end posts, rotate each post until the geotextile is wrapped completely around the post, then abut the end posts to create a tight seal as shown in Figure 1.
- Drive posts into the ground until the required fence height and/or anchorage depth is obtained.
- Bury the loose geotextile at the bottom of the fence in the upstream trench and backfill with natural soil, tamping the backfill to provide good compaction and anchorage. Figure 2 illustrates a typical silt fence installation and anchor trench placement.

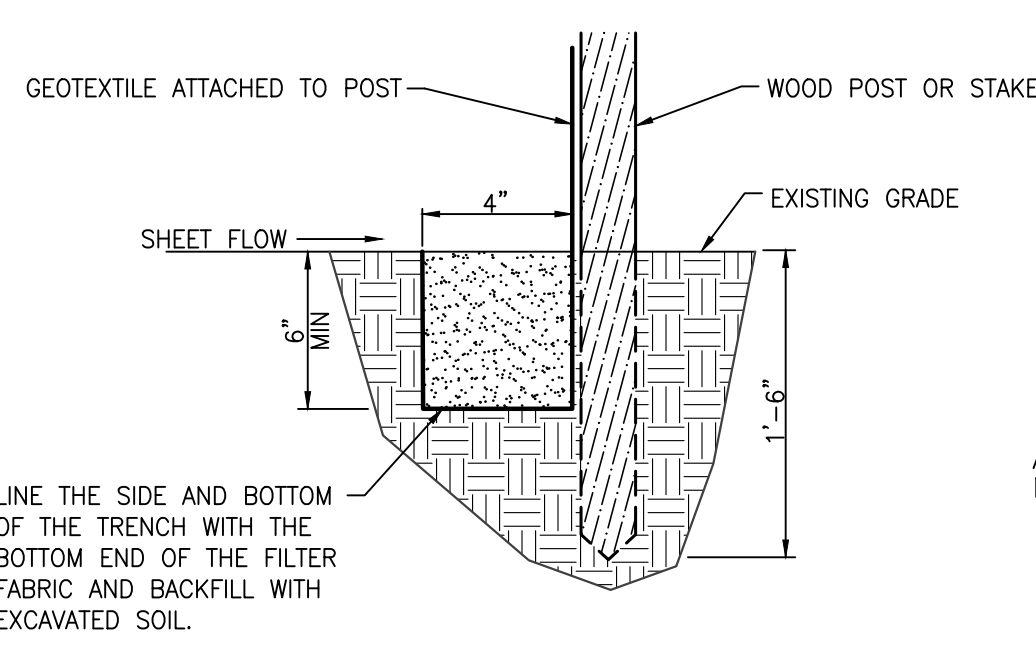

Section

FIELD ASSEMBLY:

- Excavate a minimum 15.2cm x 15.2cm (6"x6") trench at the desired location.
- Drive wooden posts, or steel posts with fastening projections, against the downstream wall of the trench. Maximum post spacing should be 2.4-3.0m (8-10ft). Post spacing

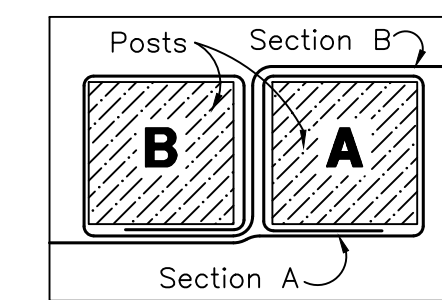
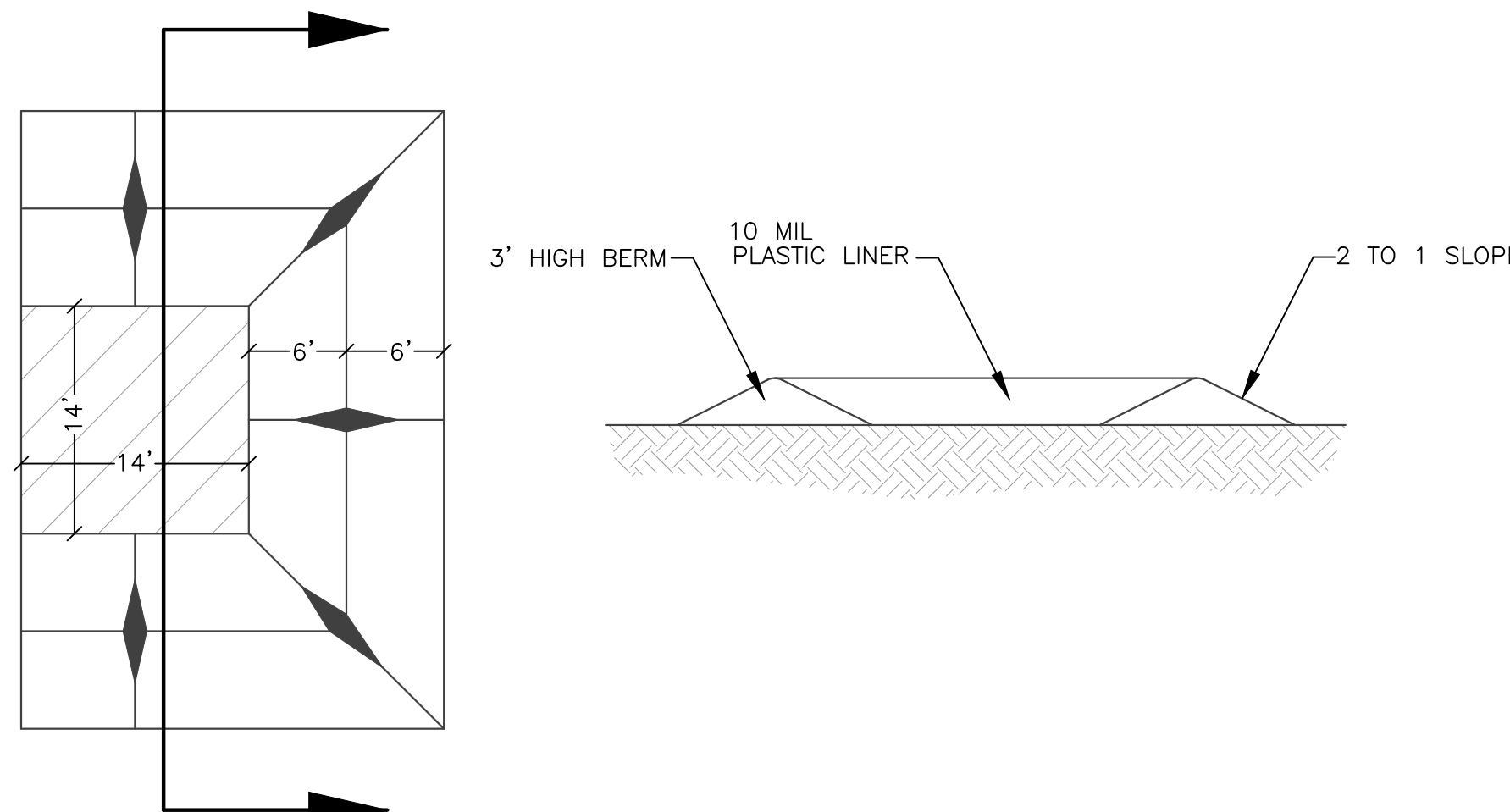

Figure 1: Top View of Roll-to-Roll Connection

Silt Fence Detail

SCALE: NONE



Concrete Washout Area w/ 10 mil Plastic Liner

SCALE: NONE

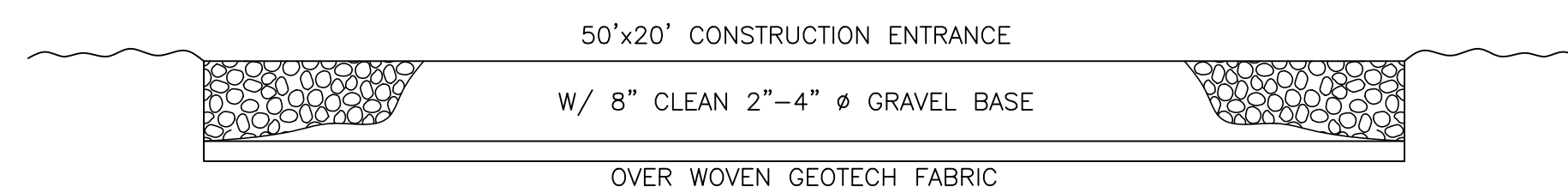

Cross Section 50' x 20' Construction Entrance

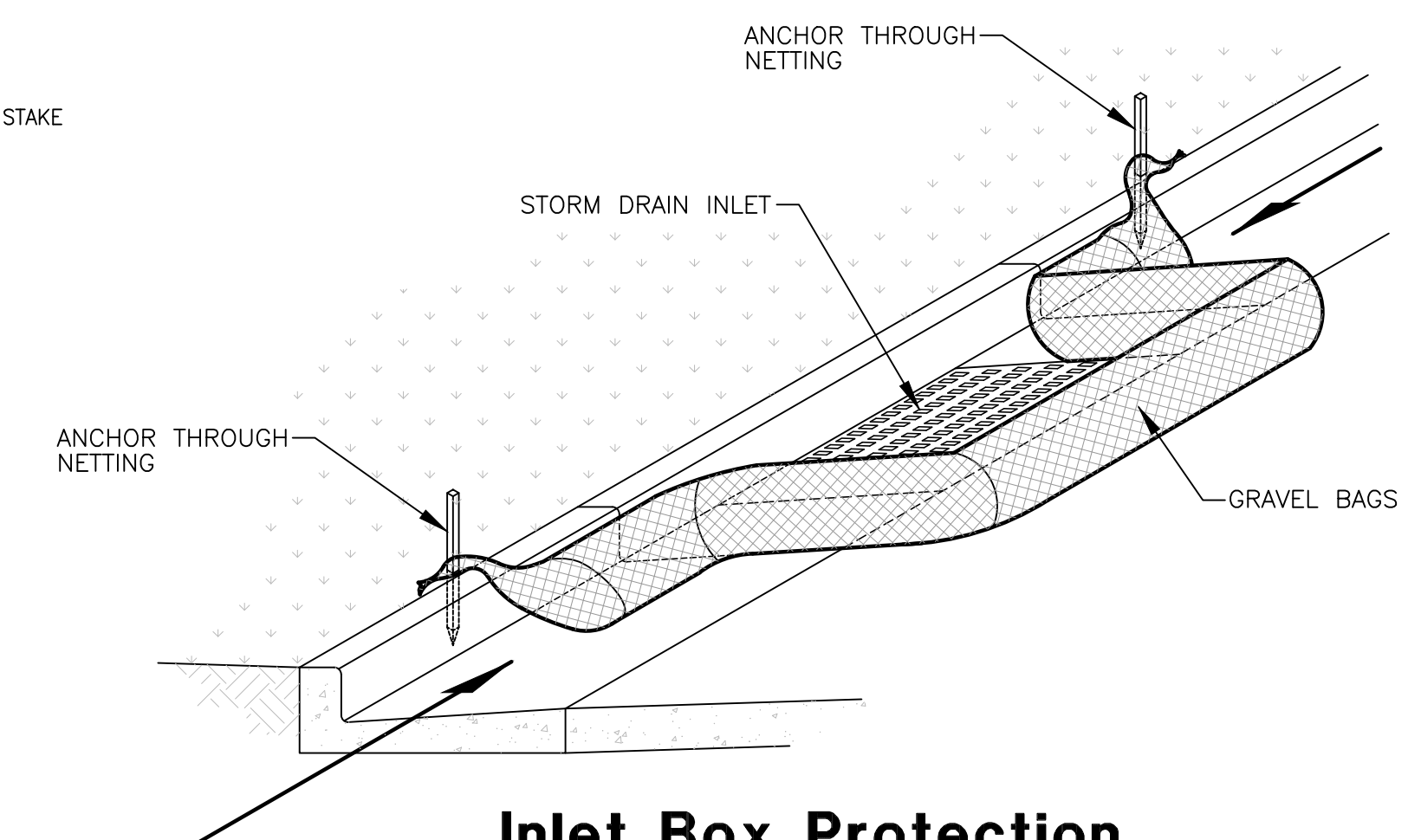

Inlet Box Protection

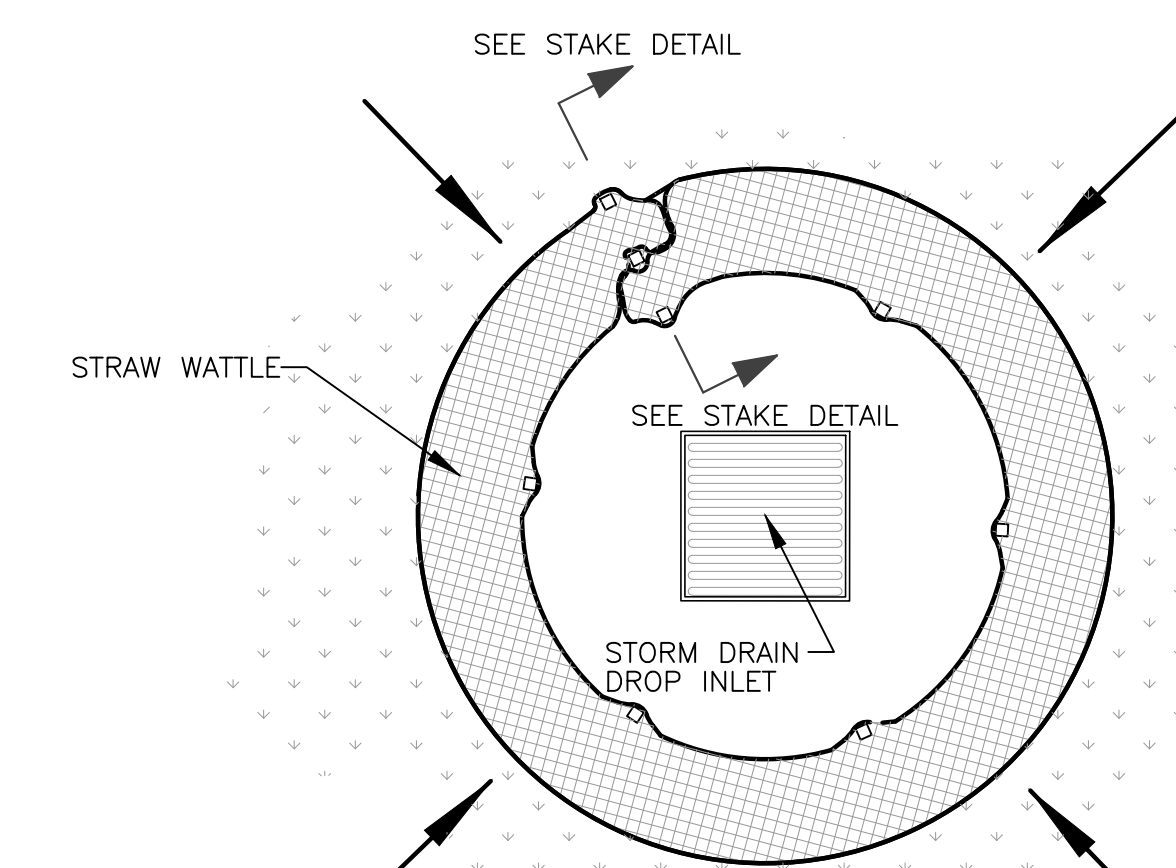

Plan View

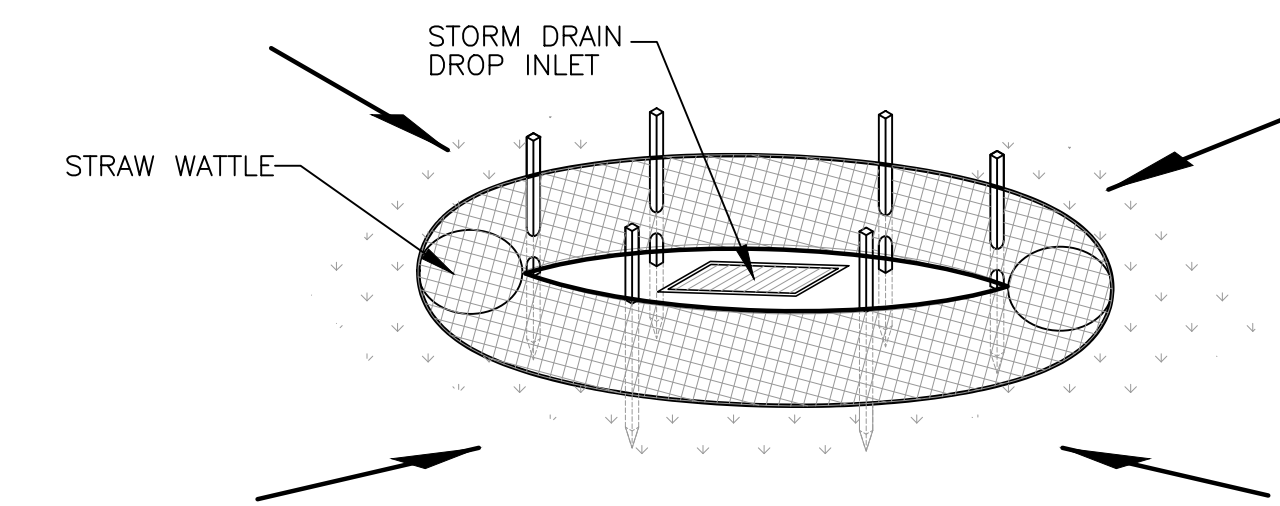

Drop Inlet Protection

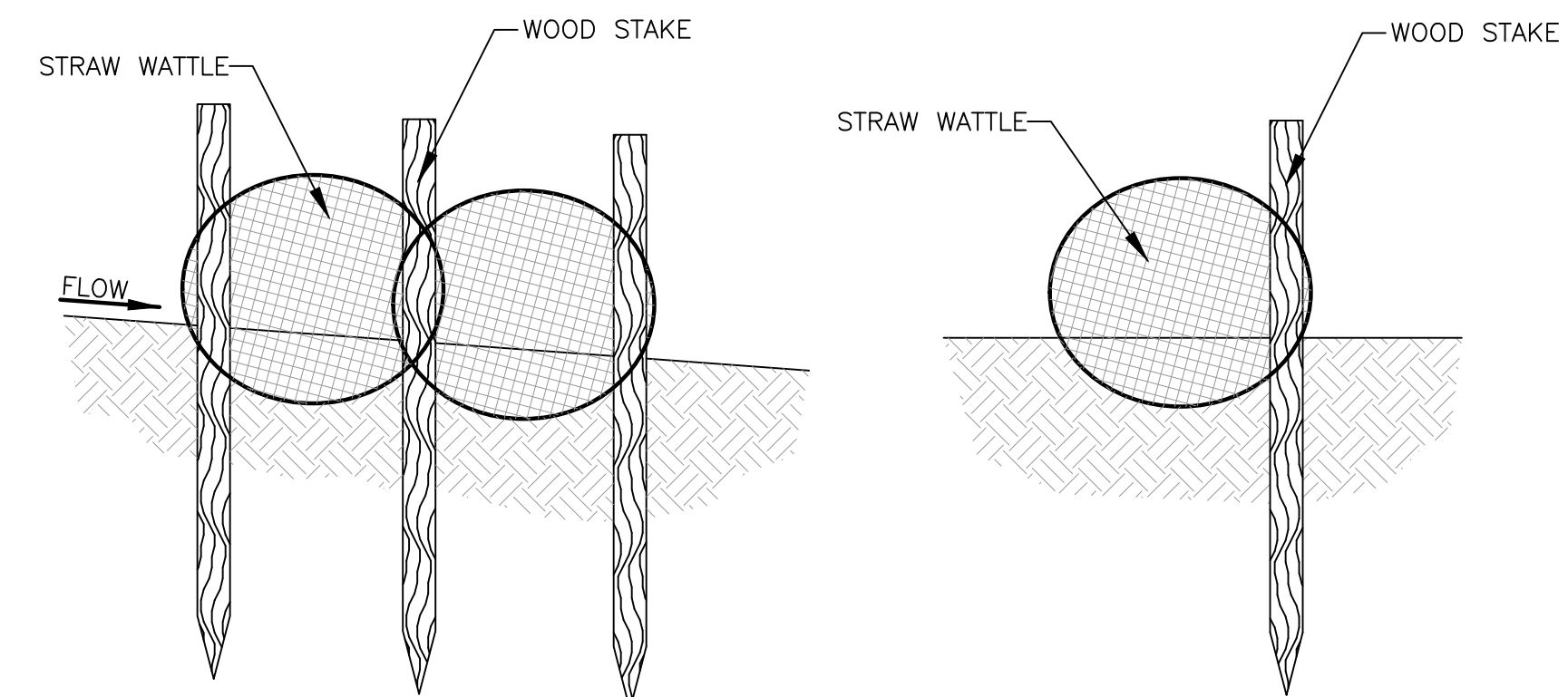

Stake Detail

Reeve & Associates, Inc.
IRA
 5160 SOUTH 1500 WEST, RIVERDALE, UTAH 84405
 TEL: (801) 621-3100 www.reeve-associates.com
 LAND ENGINEERS • CIVIL ENGINEERS • LAND SURVEYORS
 TRAFFIC ENGINEERS • STRUCTURAL ENGINEERS • GEOTECH ENGINEERS

REVISIONS

DATE	DESCRIPTION
2021.12.06	NF Added 12" Water
2022.01.18	PB Added Pump Det.
2022.04.01	NF Taylor West Weber
2022.04.14	NF Utility Location
2022.05.03	NF Relocated Irrigation
2022.05.03	NF Weber County Contm

TC Gailey Subdivision
 WEBER COUNTY, UTAH
Storm Water Pollution Prevention Plan Details

REGISTERED PROFESSIONAL ENGINEER
 5338480
 JEREMY A. DRAPER
 06/03/2022
 STATE OF UTAH

Project Info.
 Engineer: JEREMY A. DRAPER, P.E.
 Drafter: N. FICKLIN
 Begin Date: NOVEMBER, 2021
 Name: TC GAILEY SUBDIVISION
 Number: 7713-01