



# Staff Report to the Ogden Valley Planning Commission

Weber County Planning Division

## Synopsis

### Application Information

<b>Application Request:</b>	Consideration and action for the final plat approval of Summit Eden Village Nests Condominiums Subdivision
<b>Type of Decision:</b>	Administrative
<b>Agenda Date:</b>	Tuesday, January 05, 2016
<b>Applicant:</b>	Summit Mountain Holding Group, LLC
<b>File Number:</b>	UVS92004DP

### Property Information

<b>Approximate Address:</b>	Powder Mountain Ski Resort (Daybreak Ridge)
<b>Project Area:</b>	1.38 Acre (20 Nest Units)
<b>Zoning:</b>	Ogden Valley Destination and Recreation Resort Zone DRR-1
<b>Existing Land Use:</b>	Ski Resort
<b>Proposed Land Use:</b>	Residential Condominium Subdivision
<b>Parcel ID:</b>	23-012-0022
<b>Township, Range, Section:</b>	T7N, R2E, Section 8

### Adjacent Land Use

<b>North:</b>	Ski Resort	<b>South:</b>	Ski Resort
<b>East:</b>	Ski Resort	<b>West:</b>	Ski Resort

### Staff Information

<b>Report Presenter:</b>	Ronda Kippen <a href="mailto:rkippen@co.weber.ut.us">rkippen@co.weber.ut.us</a> 801-399-8768
<b>Report Reviewer:</b>	SW

## Applicable Ordinances

- Title 101, Chapter 1, General Provisions, Section 7, Definitions
- Title 104, Chapter 29 Ogden Valley Destination and Recreation Resort Zone (DRR-1)
- Title 104, Zones, Chapter 28, Ogden Valley Sensitive Lands Overlay Districts
- Title 106, Subdivisions, Chapter 1-8 as applicable

## Background and Summary

Summit Eden Village Nests Condominiums Subdivision is a phase within an approved PRUD, consisting of one lot with 20 "Nest Units" (see Exhibit A for the proposed subdivision plat). The lot is part of the Summit Eden Phase 1D Subdivision identified as "Development Parcel D" (see Exhibit B for Summit Eden Phase 1D Subdivision plat). Summit Eden Phase 1D received preliminary subdivision approval in conjunction with the County Commission's approval of the Summit at Powder Mountain PRUD on April 9, 2013 with subsequent amendments on July 9, 2013. This application was previously heard and received a positive recommendation by the Ogden Valley Planning Commission on October 22, 2013 and received approval by the Weber County Commission on January 21, 2014 (see Exhibit C for the PC and CC minutes). A time extension was granted by the Weber County Planning Director on October 16, 2014 (see Exhibit D). The applicant would now like to move forward with the recording process; however, due to timeframes that are required in the Uniform Land Use Code of Weber County (LUC), this application must go through the approval procedure as outlined in LUC §106-1-7 prior to recording the previously approved plat. The proposed subdivision and lot configuration is in conformance with the approved PRUD, current zoning and the Zoning Development Agreement Master Plan (see Exhibit E) as well as the applicable subdivision requirements as required in the LUC.

## Analysis

General Plan: The proposal conforms to the Ogden Valley General Plan by encouraging development within the existing resort-related commercial areas.

Zoning: The subject property is located in the Ogden Valley Destination and Recreation Resort Zone more particularly described as the DRR-1 zone. The purpose and intent of the DRR-1 zone is identified in the LUC §104-29-1 as:

*"The purpose of this chapter is to provide flexible development standards to resorts that are dedicated to preserving open space and creating extraordinary recreational resort experiences while promoting the goals and objectives of the Ogden Valley general plan. It is intended to benefit the residents of the county and the resorts through its ability to preserve the valley's rural character, by utilizing a mechanism that allows landowners to voluntarily transfer development rights to areas that are more suitable for growth when compared to sensitive land areas such as wildlife habitats, hazardous hillsides or prime agricultural parcels. Resorts that lie within an approved destination and recreation resort zone shall, by and large, enhance and diversify quality public recreational opportunities, contribute to the surrounding community's well-being and overall, instill a sense of stewardship for the land."*

As part of the subdivision process, the proposal has been reviewed against the current subdivision ordinance in LUC §106, the approved PRUD and the standards in the DRR-1 zone in LUC §104-29. The proposal has been reviewed against the adopted zoning and subdivision ordinances to ensure that the regulations and standards have been adhered to. It appears that the proposed subdivision is in conformance with county code. The following is a brief synopsis of the review criteria and conformance with the LUC.

Lot area, frontage/width and yard regulations: In order to allow for private ownership of the units, this phase is being developed as a condominium project. Private ownership is limited to the actual footprint and air space of each unit; the remainder of Development Parcel D is designated as common area. The landscaping plans for the common area were approved with the PRUD. All of the units have the same basic floor plan and footprint with minor variations. The building elevations and floor plans are included with the condominium plat and do comply with the architectural renderings approved with the PRUD.

Development Parcel D has access from Daybreak Ridge (a private road). Parking for the units is provided in garages. Units 1-8 have two-car garages beneath and there are two stand-alone two-car garages provided as well. The two-car garages in Units 1-8 provide one space for the nest unit to which they are attached and one space for another unit as designated on the subdivision plat. Using this method there are sufficient parking spaces for the nest units on Development Parcel D, though the stand-alone garages were shown as four-car garages in the PRUD approval.

Flood Plain: The proposed subdivision is located in a Zone "D" as determined by FEMA to be an area of undetermined flood hazards. Areas designated as Zone "D" are typically areas in which no analysis of flood hazards has been conducted.

Culinary water and sanitary sewage disposal: Culinary water and sewer service are provided by Powder Mountain Water and Sewer Improvement District.

Review Agencies: The Weber County Engineering Division, the Weber County Surveyor's Office and the Weber Fire District have reviewed and approved the proposal. All review agencies comments have been attached as Exhibit F. The conditions of approval and review agency comments from the PRUD remain in effect (see Exhibit G), in addition to the review agency comments specific to this phase.

Additional design standards and requirements: Pathways for the overall Powder Mountain development were approved with the PRUD. As part of the PRUD approval, units to be used for timeshares or nightly rentals must be shown. The designation can be accomplished with a note on the dedication plat (see note 17 on the proposed plat) and approval from the Planning and County Commission.

Tax clearance: The 2015 property taxes have been paid in full. The 2016 property taxes will be due in full on November 1, 2016.

Public Notice: The required noticing for the final subdivision plat approval has been mailed to all property owners of record within 500 feet of the subject property regarding the proposed subdivision per noticing requirements outlined in LUC §106-1-6(b).

## Summary of Planning Commission Considerations

- Does this subdivision meet the requirements of applicable County Land Use Codes?
- Does this subdivision comply with the applicable PRUD approvals?
- Does this subdivision comply with the applicable Zoning Development Agreement Master Plan approval?

## Staff Recommendation

Staff recommends final plat approval of Summit Eden Village Nests Condominiums Subdivision, consisting of one lot with 20 “Nest Units” as part of the previously approved PRUD. This recommendation for approval is subject to all review agency requirements and based on the following conditions:

1. Requirements of the Weber County Engineering Division.
2. Requirements of the Weber-Morgan Health Department.
3. Requirements of the Weber Fire District.
4. Requirements of the Weber County Surveyor’s Office.
5. Requirements of the Weber County Recorder.

This recommendation is based on the following findings:

1. The proposed subdivision conforms to the Ogden Valley General Plan.
2. With the recommended conditions, the proposed subdivision complies with all previous approvals and the applicable County ordinances.
3. The proposed subdivision will not be detrimental to the public health, safety, or welfare.
4. The proposed subdivision will not deteriorate the environment of the general area so as to negatively impact surrounding properties and uses.

## Exhibits

- A. Proposed Summit Eden Village Nests Condominium Subdivision Plat
- B. Summit Eden Phase 1D Subdivision Plat
- C. Minutes from the Oct 22, 2013 PC meeting and Jan 21, 2014 CC meeting
- D. Administratively Approved time extension
- E. PRUD site plan showing Phase 1D, Development Parcel D location and Zoning Development Master Plan
- F. Review Agencies comments
- G. List of PRUD conditions of approval

## Location Map







# SUMMIT EDEN VILLAGE NESTS CONDOMINIUMS

LOCATED IN THE NORTHEAST QUARTER SECTION 8,  
TOWNSHIP 7 NORTH, RANGE 2 EAST,  
SALT LAKE BASE AND MERIDIAN  
JANUARY 14, 2014

IF ANY UNITS ARE REPRODUCED, NOTE REQUESTED BY A  
PLANNING CONSULTANT, THE CONSULTANT'S RESPONSIBILITY IS TO  
REPRESENT THE INFORMATION AS TRUE TO THE BEST OF HIS OR HER  
KNOWLEDGE AND BELIEF AT THE DATE OF THE DRAWING. THE  
CONSULTANT DOES NOT GUARANTEE THE ACCURACY OF THE  
INFORMATION OR REPRESENTATIONS HEREON AND DOES NOT  
WARRANT THAT THE INFORMATION IS COMPLETE OR THAT THE  
REQUIREMENTS, ORDINANCES OR REGULATIONS OF ANY  
LOCAL OR STATE AGENCY WILL BE FULLY COMPLIED WITH.  
ACCEPTANCE WITH ALL REQUIREMENTS AND FEES FOR  
RECORDATION BY THE SALT LAKE COUNTY REGISTERED  
REGISTERED PROFESSIONAL ENGINEER OR ARCHITECT IS  
REQUIRED FOR THIS DRAWING TO BE VALID.  
SALT LAKE COUNTY REGISTERED PROFESSIONAL ENGINEER  
AND ARCHITECT NO. 25429-0002, L.L.C.

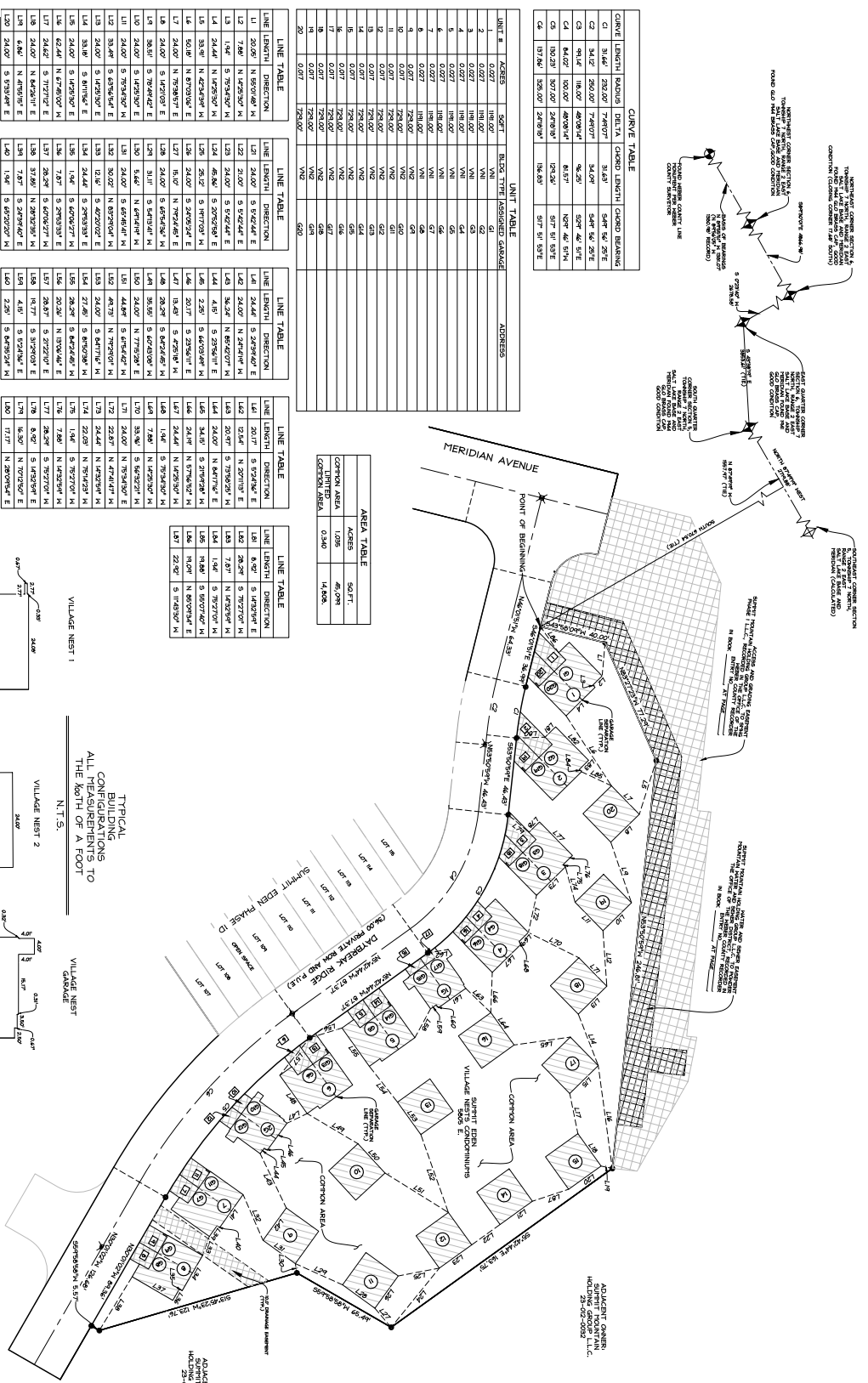

### CURVE TABLE

CURVE LENGTH	ROUND	CHD'A	CHORD LENGTH	CHORD BEARING
C1	314.0	S 103.00° W	714.97	S 46.5° E
C2	314.0	S 103.00° W	714.97	S 46.5° E
C3	44.0	N 103.00° W	48.90	S 67.00° E
C4	44.0	N 103.00° W	48.90	S 67.00° E
C5	13.25	S 103.00° W	14.58	S 71.00° E
C6	13.25	S 103.00° W	14.58	S 71.00° E

### UNIT TABLE

UNIT #	ACRES	SOFT	EXIST. TYPE	ASSIGNED GARAGE	ADDRESS
1	0.027	116.00	UNI	G1	
2	0.027	116.00	UNI	G2	
3	0.027	116.00	UNI	G3	
4	0.027	116.00	UNI	G4	
5	0.027	116.00	UNI	G5	
6	0.027	116.00	UNI	G6	
7	0.027	116.00	UNI	G7	
8	0.027	116.00	UNI	G8	
9	0.027	116.00	UNI	G9	
10	0.027	116.00	UNI	G10	
11	0.027	116.00	UNI	G11	
12	0.027	116.00	UNI	G12	
13	0.027	116.00	UNI	G13	
14	0.027	116.00	UNI	G14	
15	0.027	116.00	UNI	G15	
16	0.027	116.00	UNI	G16	
17	0.027	116.00	UNI	G17	
18	0.027	116.00	UNI	G18	
19	0.027	116.00	UNI	G19	
20	0.027	116.00	UNI	G20	

### AREA TABLE

COMMON AREA	ACRES	SOFT
COMMON AREA	1.395	45,300
COMMON AREA	0.340	14,800

### SUMMIT EDEN VILLAGE NESTS CONDOMINIUMS PLAT

LOCATED IN THE NORTHEAST QUARTER OF SECTION 8  
TOWNSHIP 7 NORTH RANGE 2 EAST SALT LAKE BASE AND  
MERIDIAN NEBER COUNTY, UTAH

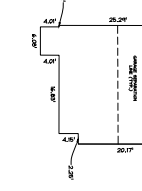
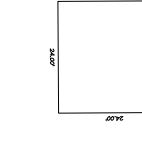
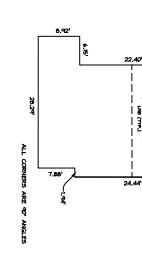

**TYPICAL**  
EIGHT (8) UNITS  
ALL CONFIGURATIONS TO  
THE NORTH OF A FOOT  
N.T.S.

REGISTERED PROFESSIONAL ENGINEER  
AND ARCHITECT  
**NVES**  
NORTH VERMONT ENGINEERING SERVICE  
1515 SOUTH CENTRAL EXPRESSWAY  
SALT LAKE CITY, UTAH 84115  
TEL: 313.536.3673 FAX: 313.536.3674  
WWW.NVES.COM  
RECORDED & RETURNED TO  
STATE OF UTAH, COUNTY OF WEBER,  
REGISTERED PROFESSIONAL ENGINEER  
ENTRY NO. \_\_\_\_\_  
DATE: \_\_\_\_\_ TIME: \_\_\_\_\_  
BOOK: \_\_\_\_\_ PAGE: \_\_\_\_\_  
FEE \$ \_\_\_\_\_  
WEBER COUNTY RECORDER

VILLAGE NEST 1 (VNI)  
 FOR  
 UNITS 1, 2, 3, 4, 5, 6, 7, & 8

N.T.S.  
 JANUARY 14, 2014

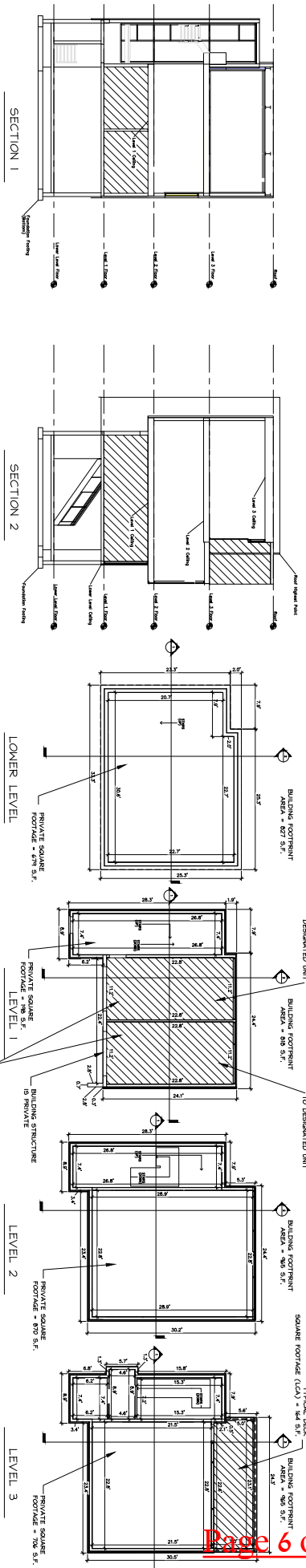

NOTE: SEE BUILDING UNIT ELEVATION TABLE FOR ELEVATION OF CEILING, FLOORS, FOUNDATION, AND ROOF ELEVATIONS.

BUILDING UNIT ELEVATION TABLE

BUILDING UNIT	Foundation (ft)		Level 1		Level 2		Level 3		Roof Highest
	Interior	Exterior	Interior	Exterior	Interior	Exterior	Interior	Exterior	
1	562.00	562.00	562.00	562.00	562.00	562.00	562.00	562.00	562.00
2	562.00	562.00	562.00	562.00	562.00	562.00	562.00	562.00	562.00
3	562.00	562.00	562.00	562.00	562.00	562.00	562.00	562.00	562.00
4	562.00	562.00	562.00	562.00	562.00	562.00	562.00	562.00	562.00
5	562.00	562.00	562.00	562.00	562.00	562.00	562.00	562.00	562.00
6	562.00	562.00	562.00	562.00	562.00	562.00	562.00	562.00	562.00
7	562.00	562.00	562.00	562.00	562.00	562.00	562.00	562.00	562.00
8	562.00	562.00	562.00	562.00	562.00	562.00	562.00	562.00	562.00

AREA DESIGNATION TABLE

PRIVATE SQUARE FOOTPRINT	297 S.F.
PRIVATE SQUARE FOOTPRINT	297 S.F.

LEGEND

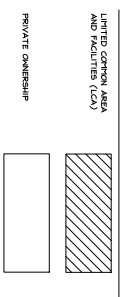

Sheet 3 of 4

Exhibit A

SUMMIT EDEN VILLAGE NESTS  
 COND UNITS  
 BUILDING FLOOR PLANS AND SECTIONS

LOCATED IN THE NORTHEAST QUARTER OF SECTION 8  
 TOWNSHIP 7 NORTH, RANGE 2 EAST SALT LAKE BASE AND  
 MERIDIAN, WEBER COUNTY, UTAH

**NVIS**  
 NADIR VERTICAL CURVE  
 REGISTERED PROFESSIONAL ENGINEER  
 1000 EAST 1000 SOUTH, SUITE 100  
 WASHINGTON, UT 84783  
 (801) 225-1111  
 www.nvis.com

RECORDED &  
 STATE OF UTAH, COUNTY OF WEBER,  
 REGISTERED AND FILED AT THE  
 CLERK'S OFFICE  
 ENTRY NO. \_\_\_\_\_ DATE \_\_\_\_\_ TIME \_\_\_\_\_  
 BOOK \_\_\_\_\_ PAGE \_\_\_\_\_ FILE # \_\_\_\_\_  
 MEMBER COUNTY RECORDER

**Exhibit A**

VILLAGE NEST 2 (VN2)

FOR UNITS 9, 10, 11, 12, 13, 14, 15, 16, 17, 18, 19, & 20

N.T.S.

JANUARY 14, 2014

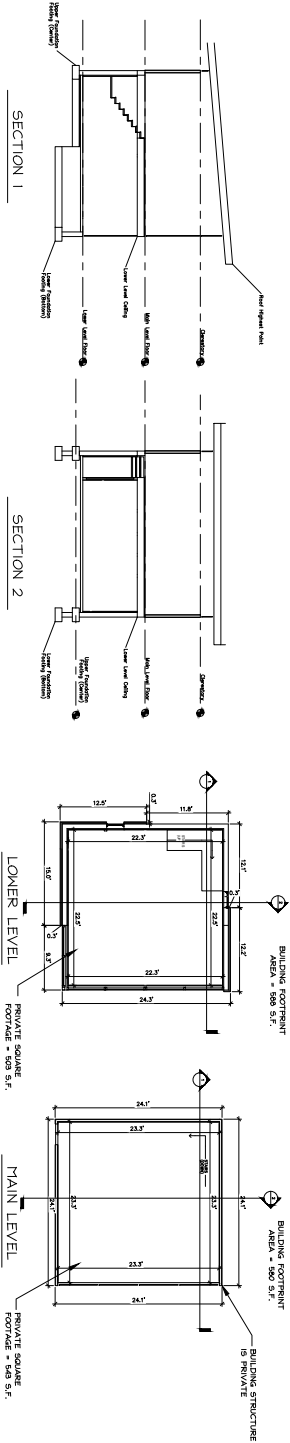

NOTE: SEE BUILDING UNIT ELEVATION TABLE FOR ELEVATION OF CEILING, FLOORS, FOUNDATION, AND ROOF ELEVATIONS.

BUILDING UNIT ELEVATION TABLE

BUILDING UNIT	Foundation (Bottom)	Flooring (General)	Lower Level Ceiling	Upper Level Ceiling	Floor Level	Ceiling	Roof Height
0	252.00	252.00	252.00	252.00	252.00	252.00	252.00
1	252.00	252.00	252.00	252.00	252.00	252.00	252.00
2	252.00	252.00	252.00	252.00	252.00	252.00	252.00
3	252.00	252.00	252.00	252.00	252.00	252.00	252.00
4	252.00	252.00	252.00	252.00	252.00	252.00	252.00
5	252.00	252.00	252.00	252.00	252.00	252.00	252.00
6	252.00	252.00	252.00	252.00	252.00	252.00	252.00
7	252.00	252.00	252.00	252.00	252.00	252.00	252.00
8	252.00	252.00	252.00	252.00	252.00	252.00	252.00
9	252.00	252.00	252.00	252.00	252.00	252.00	252.00
10	252.00	252.00	252.00	252.00	252.00	252.00	252.00
11	252.00	252.00	252.00	252.00	252.00	252.00	252.00
12	252.00	252.00	252.00	252.00	252.00	252.00	252.00
13	252.00	252.00	252.00	252.00	252.00	252.00	252.00
14	252.00	252.00	252.00	252.00	252.00	252.00	252.00
15	252.00	252.00	252.00	252.00	252.00	252.00	252.00
16	252.00	252.00	252.00	252.00	252.00	252.00	252.00
17	252.00	252.00	252.00	252.00	252.00	252.00	252.00
18	252.00	252.00	252.00	252.00	252.00	252.00	252.00
19	252.00	252.00	252.00	252.00	252.00	252.00	252.00
20	252.00	252.00	252.00	252.00	252.00	252.00	252.00

AREA DESIGNATION TABLE

FOOTPRINT	SQUARE	SQ. FT.
UNITED COMMON SQUARE FOOTAGE		0 S.F.

LEGEND

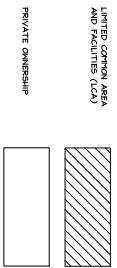

VILLAGE NEST GARAGES (VNG)

N.T.S.

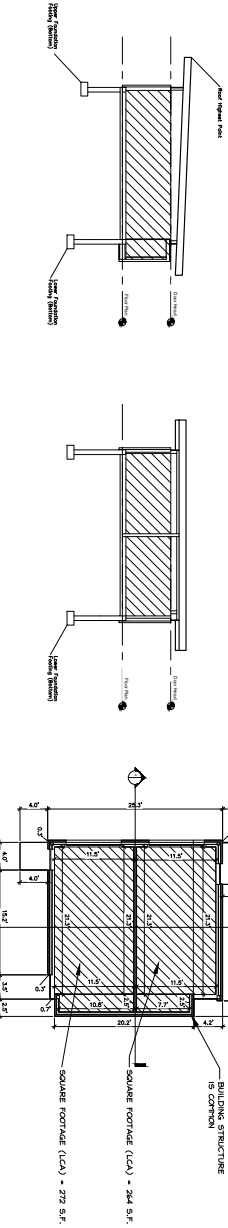

NOTE: SEE BUILDING UNIT ELEVATION TABLE FOR ELEVATION OF CEILING, FLOORS, FOUNDATION, AND ROOF ELEVATIONS.

SUMMIT EDEN VILLAGE NESTS  
 CONTINUOUS BUILDING FLOOR PLANS AND SECTIONS

LOCATED IN THE NORTHEAST QUARTER OF SECTION 8  
 TOWNSHIP 7 NORTH, RANGE 2 EAST SALT LAKE BASE AND  
 MERIDIAN, WEBER COUNTY, UTAH

BUILDING ELEVATION TABLE

Building #	Lower Foundation (Bottom)	Upper Foundation (Bottom)	Lower Level Ceiling	Upper Level Ceiling	Roof Height
26	252.00	252.00	252.00	252.00	252.00

AREA DESIGNATION TABLE

PRIVATE SQUARE	SQ. FT.
PRIVATE SQUARE FOOTAGE	508 S.F.







## Exhibit C

Minutes of the Ogden Valley Commission Regular Meeting held October 22, 2013, in the Weber County Commission Chambers, 1<sup>st</sup> Floor, commencing at 5:00 p.m.

*Present:* Pen Hollist, Chair; Ann Miller; Laura Warburton, John Howell, Kevin Parson

*Absent/Excused:* Greg Graves; Dennis Montgomery

*Staff Present:* Rob Scott, Planning Director; Sean Wilkinson, Planner; Chris Allred, Legal Counsel;  
Kary Serrano, Secretary

---

- **Pledge of Allegiance**

- **Roll Call:** Chair Hollist stated that Dennis Montgomery resigned, Greg Graves was excused, and all others are present.

1. **Minutes:**

- 1.1. Approval of the August 8, 2013 and September 24, 2013 meeting minutes

**MOTION:** Chair Hollist declared the meeting minutes of August 8, 2013 and September 24, 2013 approved as written.

Chair Hollist asked if any Planning Commissioners had any conflicts of interest or ex parte communications to declare for any of the items. There were no conflicts of interest or ex parte communications reported.

2. **Petitions, Applications and Public Hearings:**

- 2.1. **Administrative Items**

- a. **New Business:**

1. **UVS9241A:** Consideration and action on final approval of Summit at Powder Mountain Phase 1A located at Powder Mountain Ski Resort within the Forest Valley-3 Zone (FV-3), Forest-40 Zone (F-40) (Summit Mountain Holding Group LLC, Applicant)

Sean Wilkinson reviewed the staff report and mentioned that there will be a potential change in the future to this phase. The restricted lots had to be rechecked for accuracy and staff recommends approval of the current 24 lot proposal. If there are changes, the amendments will come back to the Planning Commission for an amendment. The potential change will consist of Lots 1-4, 9, and 10 being separated as Phase 1E due to access concerns, and extra engineering work that is necessary. Any approval tonight is subject to the requirements of the County Engineering Division, Weber Fire District, Weber County Surveyor, and any other agency reviews. This phase will not go to the County Commission for final approval until all review agencies have granted approval.

Eric Langvardt, Langvardt Design Group, said that he didn't have anything new and as staff has indicated the access on Lots 1-4, 9-10 need to be studied further so they can most sensibly place the access on the land. They need to clarify with their engineers with the restricted lot issue but everything else is as it was in the PRUD submittals.

**MOTION:** Commissioner Howell moved to recommend to the County Commission approval of UVS9241A subject to staff and other agencies listed in the staff report and in conformance with the General Plan and County Ordinance to include the corrections on Exhibit A, Sheets 2, 3 and 4. Commissioner Parson seconded.

**FRIENDLY AMENDMENT:** Commissioner Warburton recommended that the County receives clear information on the topographies so they can identify which lots are restricted and which are not.

**VOTE:** A vote was taken with all members voting aye and Chair Hollist declared that the motion carried (5-0).

2. **UVS9241B:** Consideration and action on final approval of Summit at Powder Mountain Phase 1B located at Powder Mountain Ski Resort within the Commercial Valley Resort Recreation-1 Zone (CVR-1), Forest Valley-3 Zone (FV-3) (Summit Mountain Holding Group LLC, Applicant)

Sean Wilkinson said Phase 1B consists of Lots 24 through what was Lot 35. Lot 35 is now Developable Parcel B, where the 15 nest units are located. Those 15 nest units are located on this parcel and the others are lots for single family dwellings. Phase 1B is the smallest phase but it does have quite a large area for open space further down into the development. Phase 1B is also split by the county line and is located in both Weber and Cache County. There is an Interlocal Agreement that was signed by both counties and Weber County has been designated as the Land Use Authority for the Cache County land.

Sean Wilkinson said these lots were identified as cabin single family lots except for the nest units on Development Parcel B, and the setbacks and height requirements were specified in the PRUD approval. Lots 24-41 all have frontage on two roads. There is the main public road (Summit Pass) and there is Heart Wood Drive which is a private road. A no access line designation is required on Summit Pass. Any approval is subject to the review agency requirements and staff is recommending approval of this phase.

Kimbal Wheatley, who resides in Huntsville, said this is the first development where the impact of the units resides in Weber County and the taxes belong to another county. He asked if the units in Cache County are in addition to the units approved in Weber County. Chair Hollist stated that the units in Cache County count against the 154 that are approved. The only thing that happens here is Lots 32, 33, & 34 will pay their taxes to Cache County. They are not bonus lots because they appear in another county.

Commissioner Howell asked how much property is in Cache County and Russ Watts, Development Director for Summit, said there are about 3,700 acres in Cache County, which is mostly ski terrain.

**MOTION:** Commissioner Parson moved to recommend to the County Commission approval of UVS9241B subject to all review agency requirements and conditions of approval in the staff report, based on its compliance with applicable land use codes. Commissioner Warburton seconded.

**VOTE:** A vote was taken with all members voting aye and Chair Hollist declared that the motion carried (5-0).

**3. UVS9241C:** Consideration and action on final approval of Summit at Powder Mountain Phase 1C located at Powder Mountain Ski Resort within the Forest Valley-3 Zone (FV-3) (Summit Mountain Holding Group LLC, Applicant)

Sean Wilkinson reviewed the staff report and said this phase has several lots with potential frontage on two roads so they will need no access lines to clarify where the access will actually come from. In addition, the lots closer to the village have no setbacks on side property lines and are very narrow lots some as small as 17-18 feet wide. Parking standards are a problem for these lots and the parking variance that was granted as part of the PRUD was for the nest units. Where these are single family dwellings, each one is required to have two side by side parking stalls. During that PRUD approval the developers stated they would be able to meet that requirement except for the nest units. On some of these lots it is impossible to meet this requirement because the lots are too narrow.

Sean Wilkinson said there are these options for parking; 1. Require the lot width to increase to accommodate side by side parking. 2. Adjust the number of side by side spaces, by allowing tandem back-to-back parking spaces. 3. Reduce the number of required parking spaces from two to one. Approval is subject to the requirements the Engineering Division, Fire District, Water and Sewer District, and other review agencies. This phase will not go to the County Commission until all the agency requirements have been satisfied.

Chair Hollist asked about access involving Lots 42 and 41; Sean Wilkinson replied this is an access exception for Lot 42 through Lot 41. That is part of the access exception application that has already been submitted.

Eric Langvardt said he wanted to address the parking issue. They would like to explore the opportunity to adjust the parking stalls whether they allow for a narrower stall or do two of them side by side. Their smallest lots are 18 feet and have 16 foot doors for two small cars. They do think it's less of a size issue on these lots and would ask for either a reduced side by side or a tandem allowance because on some of these lots tandem parking works better.

Chair Hollist asked Sean if it was possible for them to specify two parking spaces and they can be either side by side or tandem depending upon the topography. Sean Wilkinson replied the only problem that they would have is the size of the side by side where there is an actual standard that says nine feet wide.

Commissioner Howell asked about snow removal. Sean Wilkinson said some of these lots may not actually have driveways; they have zero front yard setbacks.

Eric Langvardt asked if they could they have the flexibility to do side by side or tandem depending on lot width. Side by side parking is allowed. If it is less than 20 ft. tandem parking is required.

Rob Scott said his concern is about the limited visitor parking. Russ Watts described the plan for parking at mid-mountain and shuttling to the homes.

Commissioner Howell asked for the distance from the shuttle area to the village area? Russ Watts replied that it is about 2.25 miles from mid-mountain. This issue will be addressed as part of their DRR-1 submittal.

Steve Clarke said he wanted clarification on the concept for the commercial area, the residential area, and the zero lot setbacks from the road. Chair Hollist replied that along the Summit Pass road, they have moved from the large ranchettes and the housing gets closer together with more density as they move towards the village. Sean Wilkinson replied as part of the PRUD there is no commercial in Phase 1C; this is entirely residential except for the conference center.

Commissioner Hollist asked Summit to briefly remind the Planning Commission of what is coming next. Eric Langvardt mentioned the DRR-1 rezone and future commercial areas inside and outside of the PRUD boundary.

Commissioner Parson asked if there was any overflow parking. Eric Langvardt replied there will be places for parking but for right now there is no commercial proposed. As part of the DRR-1 rezone, Summit is proposing.

**MOTION:** Commissioner Miller moved to recommend to the County Commission approval of UVS9241C including allowing tandem or side by side parking with the requirement that they need more than 20 feet to do the side by side parking. Commissioner Warburton seconded.

**VOTE:** A vote was taken with all members voting aye and Chair Hollist declared that the motion carried (5-0).

**4. UVS9241D:** Consideration and action on final approval of Summit at Powder Mountain Phase 1D located at Powder Mountain Ski Resort within the Forest Valley-3 Zone (FV-3), Forest-40 Zone (F-40) (Summit Mountain Holding Group LLC, Applicant)

**5. UVS924DP:** Consideration and action on final approval of Summit at Powder Mountain Phase 1D, Development Parcel D located at Powder Mountain Ski Resort (Daybreak Ridge) within the Forest Valley-3 Zone (FV-3), Forest-40 Zone (F-40) (Summit Mountain Holding Group LLC, Applicant)

Sean Wilkinson reviewed both staff reports UVS9241D and UVS9241DP and said Phase 1D is a 20 Lot Subdivision and the access for these lots will be on a private road. There is still a need for no access lines to determine access locations. Phase 1D has a similar situation with the parking as they had with Phase 1C because of the lot sizes. Phase 1D Development Parcel D is the "Village Nest" with 20 units in this parcel. These units have garage parking spaces designated on the subdivision plat. Some of the garage units are located underneath some of the nest units and others are just stand alone garages for parking. The unit layouts are very similar to what was proposed before, and they do meet the PRUD standards for architecture. Both of these phases will have to meet all the agency review requirements.

Chair Hollist asked what the maximum height requirement is. Sean Wilkinson said the maximum height is 35 ft.



Eric Langvardt and Ray Bertoldi discussed the design elements and how they work with the land. The uits step down the hill to preserve views and they blend in with the trees.

Commissioner Warburton asked about the square footage, not including the garage. Eric Langvardt replied that these are 1800 square feet.

Chair Hollist excused Commissioner Parson from the meeting and said they still had a quorum to continue.

**MOTION:** Commissioner Miller moved to recommend to the County Commission approval of UVS9241D including allowing tandem or side by side parking with the requirement that they need more than 20 feet to do the side by side parking. Commissioner Warburton seconded.

**VOTE:** A vote was taken with all members voting aye and Chair Hollist declared motion carried (4-0).

**MOTION:** Commissioner Howell moved to recommend approval to the County Commission of UVS924DP subject to staff and any other agency requirements. Commissioner Warburton seconded.

**VOTE:** A vote was taken with all members voting aye and Chair Hollist declared that the motion carried (4-0).

3. **Public Comments for Items not on the Agenda:** Russ Watts reported on the status of the well at Powder Mountain. They are in the final stages of testing the well; they are around 180-200 gallons per minute. They still need to pass the 24 hour test. They will have an aquifer report to present later on.
4. **Remarks from Planning Commissioners:** Commissioner Warburton reported on the Utah APA Conference. This Planning Commission does a lot of administrative work that could be done by staff. She discussed streamlining a process for administrative approvals by staff so that the Planning Commission can focus on long range planning. Commissioner Howell concurred with Commissioner Warburton.

Chair Hollist brought up the Ogden Valley Charrette that will be worked on in January and February. Several professors from Utah State and Weber State will lead teams on various topics affecting Ogden Valley.

Dr. Bell scheduled Thursday at 10:00 A.M. to look at things that they are talking about in Ogden Valley.

5. **Report from the Planning Director:**
  - a. **Information Item:** Powder Mountain Park and Ride Extension: Sean Wilkinson said two years ago the Powder Mountain Park and Ride was granted a two extension through October 2013. The request is for an extension until October 2015. Two years ago when the Planning Commission approved the first extension they had indicated that staff would do the review and determine whether or not another extension would be granted. They have received some documents from Summit indicating they have been very successful with the Park and Ride. Last year there were 15, 560 riders between UTA and the Powder Mountain Shuttles. Of those riders 57% began their journey in Ogden on the bus up to the mountain. The Park and Ride lot in Eden seems to be working very well and there have not been any complaints or any problems. Staff has determined that a two year extension will be granted through October 2015, however this issued will be opened up further as part of the upcoming DRR-1 Rezone application.

Steve Clarke said he has worked with Dr. Lee Schussman and other individuals on future general planning for a transportation center that would provide the option for many people to come to Eden and be able to enjoy commercial aspects of Eden area. He is pleased with the two year extension and hoped that would continue to develop.

Rob Scott mentioned the APA UT award of merit for the Agri-Tourism Ordinance and acknowledged the Planning Commission and Scott Mendoza who was the project coordinator. The next item is that Dennis Montgomery has resigned from the Planning Commission and we have advertised for his replacement. The County Commission has made some significant decisions; they approved the Ogden Valley Pathway

Master Plan and map and have set November 19th as the public hearing date for consideration of the amendments to the Modern Income Housing Plan.

6. **Remarks from the County Attorney:** There were no remarks from the County Attorney.
7. **Adjourn:** The meeting was adjourned at 7:00 P.M.

Kary Serrano, Secretary,  
Weber County Planning Division

**MINUTES  
OF THE BOARD OF COMMISSIONERS OF WEBER COUNTY**

Tuesday, January 21, 2014 - 10:00 a.m.  
Commission Chambers, 2380 Washington Blvd., Ogden, Utah

*In accordance with the requirements of Utah Code Annotated Section 52-4-7(1)(d), the County Clerk records in the minutes the names of all citizens who appear and speak at a County Commission meeting and the substance "in brief" of their comments. Such statements may include opinion or unreported facts. The County does not verify the accuracy or truth of any statement but includes it as part of the record pursuant to State law.*

**COMMISSIONERS:** Kerry W. Gibson, Chair, Jan M. Zogmaister and Matthew G Bell.

**OTHERS PRESENT:** Ricky D. Hatch, County Clerk/Auditor; David C. Wilson, Deputy County Attorney; Fátima Fernelius, of the Clerk/Auditor’s Office, took minutes.

- A. WELCOME – Chair Gibson
- B. PLEDGE OF ALLEGIANCE – Deputy Ray Day
- C. THOUGHT OF THE DAY – Commissioner Bell

**D. CONSENT ITEMS:**

- 1. Purchase Orders for \$1,367,920.56
- 2. Warrants #305551- #305757 for \$1,433,915.96
- 3. Minutes for the meetings held on January 7 and 14, 2014
- 4. New business licenses
- 5. New beer licenses
- 6. Retirement Agreement with Ann M. Stark – Contract C2014-11  
Commissioner Bell moved to approve the consent items; Commissioner Zogmaister seconded, all voting aye.

**E. ACTION ITEMS:**

**1. FIRST READING OF FEE ORDINANCE AMENDMENTS RELATING TO THE SOLID WASTE DIVISION OF THE WEBER COUNTY OPERATIONS DEPARTMENT**

Gary Laird, of the County Solid Waste Division, presented changes to the transfer station tipping fee (increasing to \$32/ton from \$30/ton) and the demolition and construction waste tipping fee (decreasing to \$26/ton from \$30/ton). No price change has occurred in seven years. He noted that they have seen a decrease in waste for the last several years at the Transfer Station. The commissioners noted that a lot of related discussion has occurred recently, including at a WACOG meeting. The changes take effect July 1, 2014.

Commissioner Zogmaister moved to approve the first reading of the fee ordinance amendments relating to the Solid Waste Division of the County Operations Department; Commissioner Bell seconded, all voting aye.

**2. CONTRACT WITH WHITAKER CONSTRUCTION FOR THE OGDEN BAY WATERFOWL MANAGEMENT AREA PROJECT AS PART OF THE WEBER EMERGENCY WATERSHED PROTECTION PROJECT – CONTRACT C2014-12**

Jared Andersen, County Engineer, stated that the county went through a qualification bid process on awarding this contract. The selection committee unanimously selected Whitaker Construction. Commissioner Bell moved to approve Contract C2014-12 with Whitaker Construction for the Ogden Bay Waterfowl Management Area project as part of the Weber Emergency Watershed Protection Project; Commissioner Zogmaister seconded. Commissioners Bell and Commissioner Zogmaister voted aye and Chair Gibson voted nay.

**3. FIRST AMENDMENT TO THE CITYWATCH ONLINE SERVICE AGREEMENT EXTENDING OUR CURRENT CONTRACT WITH CITYWATCH FOR ANOTHER YEAR – CONTRACT C2014-13**

Lance Peterson, of County Emergency Management, noted that for the past three years the county has had an emergency alert notification computer program service through CityWatch. This renews the contract for one more year at the same price of the past contract. The \$66,000 is 100% reimbursable through a Homeland Security grant.

## Exhibit C

Commissioner Bell moved to approve Contract C2014-13, first amendment to the CityWatch Online Service Agreement extending our current contract with CityWatch for another year; Commissioner Zogmaister seconded, all voting aye.

#### 4. **CONTRACT WITH PING4ALERTS INC., TO PROVIDE WIDER AREA EMERGENCY NOTIFICATIONS VIA CELL PHONE – CONTRACT C2014-14**

Lance Peterson, of County Emergency Management, presented this license agreement for \$20,001 through 12/31/2015 with two extensions for a \$20,000 total. He noted that alerts can now be sent to geographic areas.

Commissioner Bell moved to approve Contract C2014-14 with Ping4Alerts Inc., to provide wider area emergency notifications via cell phone; Commissioner Zogmaister seconded, all voting aye.

#### 5. **SITE DEVELOPMENT AGREEMENT FOR \$2,475.00 FOR REMOVAL OF THE TEMPORARY TRAILER AND LANDSCAPING AT WOLF MOUNTAIN (NOW KNOWN AS SKYLINE MOUNTAIN BASE) – CONTRACT C2014-15**

Sean Wilkinson, County Planning Division Director, noted that Wolf Mountain is undergoing some changes, including a name change and updates to their site plan. The temporary trailer had been approved for up to five years and the associated landscaping was never installed. The developers have put up a financial guarantee for the removal of the trailer and the four 6 ft. pine trees in pots.

Commissioner Zogmaister moved to approve Contract C2014-15, Site Development Agreement for \$2,475.00 for the removal of the temporary trailer and landscaping at Wolf Mountain/Skyline Mountain Base; Commissioner Bell seconded, all voting aye.

#### 6. **FINAL APPROVAL OF SUMMIT EDEN PHASES 1A, 1B, 1C, 1D, SUMMIT EDEN RIDGE NESTS –P.R.U.D., SUMMIT EDEN VILLAGE NESTS CONDOMINIUMS AND THE ROAD DEDICATION PLAT FOR SUMMIT PASS AND SPRING PARK**

Sean Wilkinson, County Planning Division Director, showed an area map. He said that these subdivision and road dedication plats for the development at Powder Mountain are complete. All the agency reviews have come back favorable, all necessary changes have been made, and the Mylar plats have been signed by the County Surveyor's Office.

In 2013 the P.R.U.D. was approved for 154 units at Powder Mountain. These phases encompass 148 of those 154 units. Six units that were in the very first phase are not being developed at this time. All P.R.U.D. and Planning Commission conditions have been addressed. The Utah Division of Drinking Water has granted plan approval of the Hidden Lake Well, construction has begun on the water tank, and Summit has filed for annexation into the Powder Mountain Water & Sewer District. The Powder Mountain District engineer has concluded his plan review and is waiting for the District Board to authorize the release of the approval letters for the upgrade of the sewer system. There are approximately 40 documents (easements, agreement, conveyances, etc.) associated with this subdivision. Some of those are still under review but will be completed and recorded at the same time as all of the plats.

Almost all of the improvement costs for the subdivision are currently in escrow but there is a shortage of approximately \$233,866.94, based on cost estimates submitted by Summit. This amount will have to be provided before all the plats can be recorded. There are only two public roads (Summit Pass and Spring Park) and construction began last year. Commissioner Bell said that this is a major milestone for this project. He noted that most county departments have been involved with it, and that county staff has put in thousands of hours into this project, which has been scrutinized from many angles, and that it is difficult for the public to grasp and see all the work that has been done. Commissioner Zogmaister echoed Commission Bell's comments about the time, effort and expertise that have been put into this project and stated that the public will see an excellent product that comes from all parties.

Tom Jolley, Executive Vice President/General Counsel for Summit Mountain Holding Group, on behalf of the developer sincerely thanked the commissioners and county staff for the thousands of hours stating that it represents a major milestone for the development. They are grateful to all county staff for the enormous amount of work. He had the signed documents by the developer that included changes requested by the County Attorney and Surveyor's Offices.



Commissioner Bell moved to grant final approval of Summit Eden Phases 1A, 1B, 1C, 1D, Summit Eden Ridge Nests – P.R.U.D., Summit Eden Village Nests Condominiums and the road dedication Plat for Summit Pass and Spring Park; Commissioner Zogmaister seconded, all voting aye.

**7. REQUEST FOR CONTRACT WITH WEBER COUNTY MOSQUITO ABATEMENT DISTRICT TO PROVIDE EFFECTIVE AND EFFICIENT CORE ADMINISTRATIVE SERVICES TO THE DISTRICT**

This item had been handled last week.

**8. FIRST READING OF AN ORDINANCE WHICH WOULD SEPARATE THE OFFICE OF THE WEBER COUNTY RECORDER/SURVEYOR INTO SEPARATE OFFICES; WITH THE WEBER COUNTY RECORDER AND WEBER COUNTY SURVEYOR TO BE ELECTED IN THE 2014 ELECTION CYCLE, WITH THIS ORDINANCE TO TAKE EFFECT ON THE FIRST MONDAY IN JANUARY, 2015**

Chair Gibson noted that a public meeting was held Friday on this item. The commissioners have been available since then to speak with those who wished to address the issue privately. The commissioners continue to study efficiency and budgetary implications. David Wilson, Deputy County Attorney, explained that if the Commission approved a first reading today they would have opportunity to consider it next week and if they did not take action today this issue could not be addressed for six years.

Commission Zogmaister noted that people have been coming to the commissioners' offices since Friday to voice their opinions and the commissioners have also received emails and telephone calls. It has been good to hear the perspectives from those who receive the services, etc. She noted that there are differences on the proposed budgets by Mr. Rowley and Ms. Kilts; some of that is due to the philosophy on how they would run the offices and she would like those figures clarified. The reasons given for consolidation seven years ago were for efficiency and to save money and it is important to see if those have been accomplished.

Commissioner Zogmaister moved to approve the first reading of the ordinance which would separate the office of the Weber County Recorder/Surveyor into separate offices; with the Weber County Recorder and Weber County Surveyor to be elected in the 2014 election cycle, with this ordinance to take effect on the first Monday in January 2015; Commissioner Bell seconded, all voting aye.

**F. ASSIGN PLEDGE OF ALLEGIANCE & THOUGHT OF THE DAY FOR TUESDAY, JANUARY 28, 2014, 10 A.M.**

**G. PUBLIC COMMENTS:**

Jeanen Smith, Recorder/Surveyor mapper, stated that when she started working for the Recorder's Office 20 years ago she had been impressed by the dedication and work ethic in that office. She added that all the mappers are State certified cadastral mappers.

When the offices combined in 2007, they hoped this would work and tried very hard to make it work; unfortunately it did not. She has witnessed the Recorder's Office slide slowly down in efficiency and morale. The Recorder's Office is down five employees and she asked why. She stated that there is no clear leadership within the Recorder's Office. She asked why the Surveyors have a chief deputy, an administrative assistant and the elected official but the Recorder has no voice, no clear leadership. They have the knowledge and expertise but no authority was assigned to anyone to carry out those duties. Sometimes the problems pile up and there has been no authority to handle them. There is no supervisor with Recorder knowledge that is over the front counter and the chain of command has been broken. Because of this the office is not functioning efficiently. Other county offices have told her that because of some of the policies their work load has increased dramatically. The abstracts of taxpayer records have been abstracted against when there was no description, and her understanding is that a description is necessary. Over abstracting of documents can cause this problem, which she said is another current policy. Ms. Smith did not wish to portray that Mr. Rowley had intentionally caused these problems, stating that he is an excellent surveyor but thinks like a surveyor. She outlined inherent differences between the Recorder's Office and the Surveyor's Office, stating that there has to be a check and balance. She stated that one person cannot wear both hats in that office.

## Exhibit C

They map for taxation purposes only and are expected to record to make a history of all documents, which is a sacred trust. She believes the Recorder's Office can function effectively without a chief deputy and administrative assistant and did so for years like when she first started working there, and the current staff can handle it without increased costs.

Ms. Smith gave the parallel of combining the police and fire departments, then getting rid of employees and training the police to go put out fires and the fire department to handle domestic disputes. She stated that these two offices do not function together, both are needed and our county is large enough to have both offices. As a taxpayer, she wants her records safeguarded by those for whom this is their priority. They have been expressing their concerns for the last seven years about this issue. She urged the Commission to separate these offices and restore the Recorder's Office to the previous standard.

Lance Jensen, a title searcher for 20+ years, echoed Ms. Smith's comments. The efficiencies in the Recorder's Office determines whether or not one is able to get the title work, which affects loans, sales, etc., thus the work of the Recorder's Office is crucial. It is important to have an efficient Recorder's Office. He stated that they thought it was a bad idea to combine those offices in 2007 and it is still a bad idea. He said that title companies support the separation of the two offices for efficiency and taxpayer services.

Connie Brand noted that she knows Mr. Rowley and they happen to live in the same neighborhood. She worked for over 25 years with Clark County, Las Vegas—the majority in the Assessor's Office (which handled parceling functions). She did not understand how the separation would make the Recorder's Office more efficient and productive. She feels that with separation there would be two elected officials that may put procedures in place that may be redundant and possibly conflict, and that it would be more costly. She feels that the current procedure of assigning new parcel numbers and retiring the other parcel numbers is a superior method to ensure a cleaner parcel history and she can understand why the Utah Tax Commission suggested the current procedure, which she said has been industry standard for decades and can reduce confusion and mistakes. She said that there may be management and training issues, employees with longer tenures may not feel listened to, additional employees may need to be hired (since they decreased by 5), and team building may be necessary, but she feels that these issues can be addressed.

Jeff Hales, Weber County resident, a real estate agent/developer for the past 27 years, is very involved with the county's planners, mappers, recorders, surveyors, health department, etc. He has dealt with the subject office as separate and as consolidated and has found that things have become more cumbersome over the years, but perhaps more has been asked of those in their positions. He said that Mr. Rowley is a wonderful man but may be spread a little too thin. As properties are divided, he has noticed that they become log-jammed in the Surveyor's Office. They are competent people and work hard but he feels strongly that the separation is best so that the two departments can act distinctively and that it would free up the time for the Surveyor to meet the needs of his department a bit better.

Lynda Pipkin sees valid points on both sides. She feels that one week to accomplish all the research to make this decision is not sufficient and asked why this issue was not brought up before.

Ernest Rowley, County Recorder, Surveyor, noted that obviously there is a difference of opinion on both sides regarding how the separation of the offices would function regarding staffing. He said that Ms. Kilts and others have indicated the staffing level is fine right now, thus he does not feel that the concern of backlog is a valid concern. If the offices are separated there would be a new elected official and Ms. Kilts would no longer be able to do mapping and that position would need to be filled. At minimum there would be an increase for the elected official's salary. If separated, the salaries of the Surveyor's Office will remain the same but will change in the Recorder's budget. He said that he has operated that office in the most cost effective manner. He referred to Ms. Smith's question as to why the Recorder does not have a chief deputy stating that was a Commission decision made seven years ago, at which time he had asked for one. He has a supervisor for the front area. Debbi Conley also manages the front counter and regarding the allegations that she does not have the knowledge to handle that area Mr. Rowley said that it is the employees' responsibility to be able to handle the front counter, and they can come to him if needed. Ms. Kilts is the mapping supervisor and she can consult with him if needed.

**Exhibit C**

Mr. Rowley cited from the State’s Property Tax Division Standards of Practice guidelines that when parcels are divided new parcel numbers shall be assigned and old parcel numbers permanently retired. He stated that this is not law but is the reason for his current practice. He stated that legislation passed directing County Recorders to spread the abstracted documents in the indexes and his policies are in compliance with the State. He studies as much as possible about the subject of real estate title. Mr. Hales had stated that there are inefficiencies and he agrees. The office was doing fine until this spring when Powder Mountain/Summit brought their very large project to the county. It has taken two full time staff to deal with that for the last several months. He said that backlog is due to a staffing issue. Chair Gibson noted that the county has experienced a unique year or two with unexpected demands on many county offices.

Leann Kilts referred to Mr. Rowley’s comments that at the time the offices were combined there was no chief deputy for the Recorder but in seven years there is still no chief deputy or administrative assistant—there has been no such help for the Recorder. Additionally, the Recorder lost five employees and supervisors. She had also suggested at the first meeting after the consolidation occurred that they continue having the useful monthly meetings, but Mr. Rowley did not continue them. They do not have staff or supervisor meetings, and some of the office feels there is no direction. Ms. Kilts said that they take their questions to Mr. Rowley because he is the Recorder/Surveyor, and they want those decisions to come from him.

Ms. Kilts is under the understanding that Miradi was created so that they could track subdivisions and see where the bottlenecking comes from. Miradi has been online for several years and she believes that the accountability is not just recent Powder Mountain/Summit problems. By separating the offices, she would like to restore the integrity of the Recorder’s Office. She feels the Recorder’s Office has no say, that when they voice concerns or comments those fall on deaf years. She would like to restore communication with other county offices, title companies, taxpayers, and improve customer service, which she feels has been lost. Customer service is important to her, and the office is also very important to her. She expressed her willingness to continue working with Mr. Rowley if the office is separated and stated that her heart and soul is in Weber County and with the taxpayers. She stated that first and foremost the customers deserve to have their needs and concerns met. She feels that the employees in the Recorder’s Office have been swept under the rug by this administration. She reiterated that the office should be separated.

**H. ADJOURN**

Commissioner Bell moved to adjourn at 11:21 a.m.; Commissioner Zogmaister seconded, all voting aye.

Attest:

\_\_\_\_\_  
Kerry W. Gibson, Chair  
Weber County Commission

\_\_\_\_\_  
Ricky D. Hatch, CPA  
Weber County Clerk/Auditor



# Staff Report for Administrative Approval

Weber County Planning Division

## Synopsis

### Application Information

**Application Request:** Consideration and action on a request for a one year time extension of final approval for The Summit Eden Village Nest Condominiums.

**Agenda Date:** Thursday, October 16, 2014

**Applicant:** Summit Mountain Holding Group, LLC

**File Number:** UVS 924DP

### Property Information

**Approximate Address:** Powder Mountain Ski Resort (Daybreak Ridge)

**Project Area:** 1 Acre with 20 Units

**Zoning:** Forest Valley 3 Zone (FV-3) Forest-40 Zone (F-40)

**Existing Land Use:** Ski Resort

**Proposed Land Use:** Residential Condominium Subdivision

**Parcel ID:** 23-012-0032

**Township, Range, Section:** T7N, R2E, Section 8

### Adjacent Land Use

<b>North:</b>	Ski Resort	<b>South:</b>	Ski Resort
<b>East:</b>	Ski Resort	<b>West:</b>	Ski Resort

### Staff Information

**Report Presenter:** Jim Gentry  
jgentry@co.weber.ut.us  
801-399-8767

**Report Reviewer:** SW

## Applicable Ordinances

- Weber County Land Use Code Title 106 (Subdivisions)
- Weber County Land Use Code Title 104 (Zones) Chapter 14 (FV-3 Zone)
- Weber County Land Use Code Title 104 (Zones) Chapter 9 (F-40 Zone)

## Background

The Summit Eden Village Nest Condominiums (formerly Summit at Powder Mountain Phase 1D, Development Parcel D) received final subdivision approval on October 22, 2013. The applicant is requesting a 12-month time extension, as it is their intention to break ground on this phase of development in 2015, and by waiting an escrow for the improvements won't have to be given until they are ready to do the development.

Title 106 (Weber County Land Use Code) Chapter 1 Section 7(b) states: "A final subdivision plat or a phase of a subdivision that receives a recommendation for final approval from the Planning Commission shall be offered to the County Commission for final approval and recording within one (1) year from the date of the Planning Commission's recommendation for final approval. After one (1) year from that date, the plat shall have no validity. Subdivisions with multiple phases must record a new phase within one year from the date of the previous phase being recorded until the subdivision is completed or the plat shall have no validity. The Planning Director may grant a onetime extension for final subdivision approval for a maximum of one (1) year. **A multiple phase subdivision may receive only one time extension, not one time extension per phase.**"

The Summit Eden Village Nest Condominiums is the first Phase of the subdivision in need of an extension under the current subdivision ordinance regulations. If this extension is granted, the subdivision expiration date will be October 22, 2015. All of the requirements and conditions of approval for the subdivision remain unchanged.



## Exhibit D

### Conformance to the General Plan

The request meets the requirements of Title 106 (Weber County Land Use Code) Chapter 1 Section 7(b) and does not affect the subdivision's compliance with the Ogden Valley General Plan.

### Conditions of Approval

- All of the requirements and conditions for The Summit Eden Village Nest Condominiums remain unchanged.

### Administrative Approval

The request for approval of a one year time extension (through October 22, 2015) for The Summit Eden Village Nest Condominiums is hereby approved based on the request meeting the requirements of Title 106 (Weber County Land Use Code) Chapter 1 Section 7(b).

  
\_\_\_\_\_  
Sean Wilkinson  
Weber County Planning Director

  
\_\_\_\_\_  
Date

### Exhibits

- A. Applicant's Request Letter



October 13, 2014

Sean Wilkinson  
Weber County Planning Director  
2380 Washington Blvd  
Ogden, UT 84401

**RE: Extension Request for Summit Eden Village Nests Condominiums**

Mr. Wilkinson-

It has been our pleasure working with you on the various projects at Powder Mountain. This letter is to request a one year extension of the condominium plat approval for Summit Eden Village Nests Condominiums that was approved on January 21, 2014 by the County Commission.

The plat has been approved for recording, but requires an additional \$223,866.94 escrow deposit prior to recording. It is our understanding that our current approval expires on October 17, 2014. We plan to break ground on the project next year, thus our request for the extension.

Submitted with this request is a \$300.00 check for the extension fee. Please let us know if there is any further information you require to grant the request. Thank you for all of your continued support and help with the development at Powder Mountain.

Sincerely,

A handwritten signature in blue ink, appearing to read "Russ Watts", with a horizontal line extending from the end of the signature.

Russ Watts  
Watts Enterprises  
5200 South Highland Drive, Suite 101  
Salt Lake City, UT 84117  
(801)-673-5630



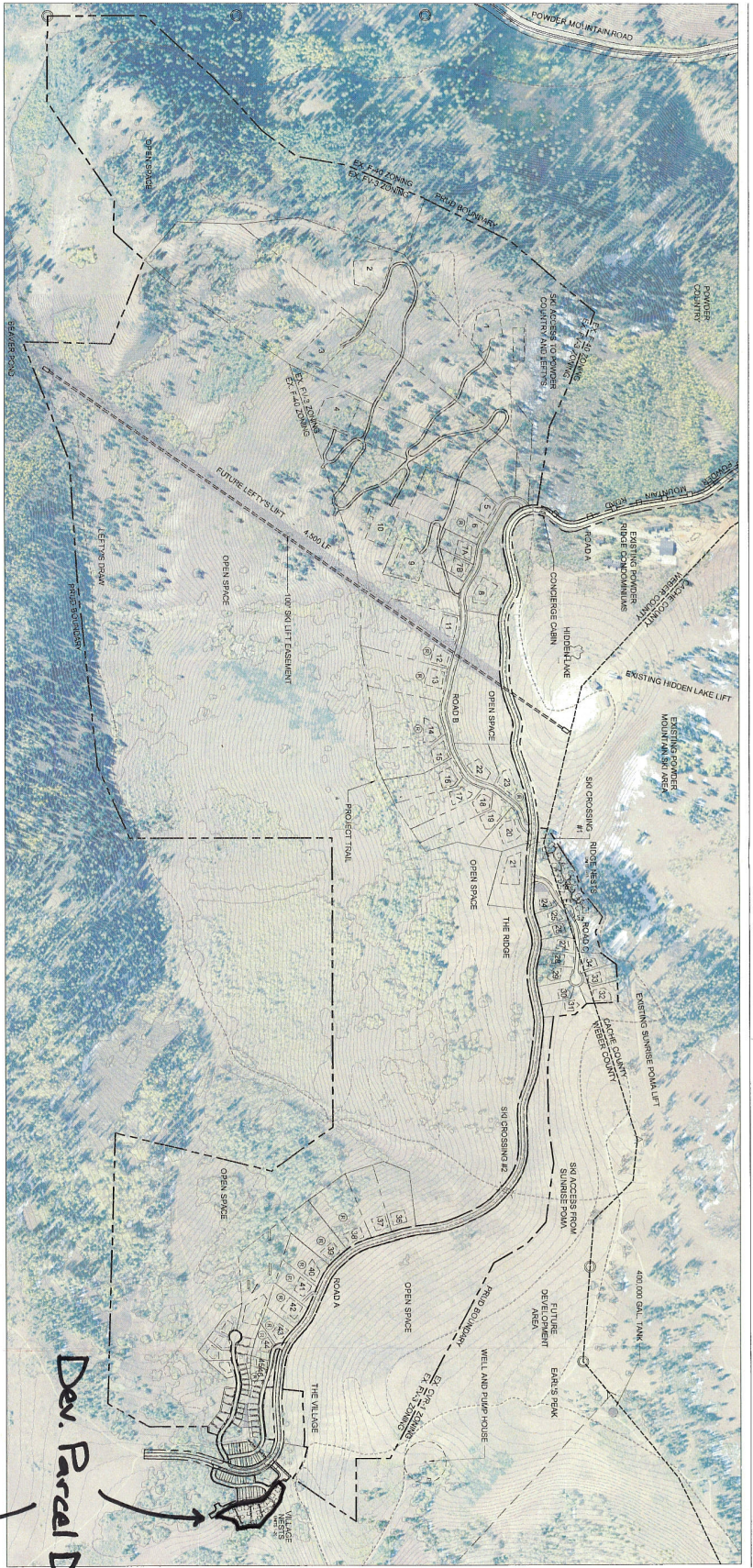

**PRUD DEVELOPMENT DATA**

TOTAL PRUD BOUNDARY AREA	594.23 ACRES
ZONE P-V-3 AREA	392.04 ACRES
ZONE P-4-D AREA	194.83 ACRES
ZONE CVR-1 AREA	2.46 ACRES
CACHE COUNTY AREA	4.90 ACRES
ROAD ROW AREA	18.86 ACRES
SLOPES > 40%	171.85 ACRES
NET DEVELOPABLE AREA	463.42 ACRES
PROPOSED LOTS	116 LOTS
PROPOSED UNITS	154 UNITS
ESTATE SINGLE FAMILY	28 UNITS
CABIN SINGLE FAMILY	11 UNITS
HILL-SIDE SINGLE FAMILY	35 UNITS
VILLAGE SINGLE FAMILY	17 UNITS
VILLAGE LITERATION ST	35 UNITS
NESTS	35 UNITS
PROPOSED DENSITY	1 UNITS/60 ACRES
PROPOSED OPEN SPACE	384.19 ACRES (64.6%)

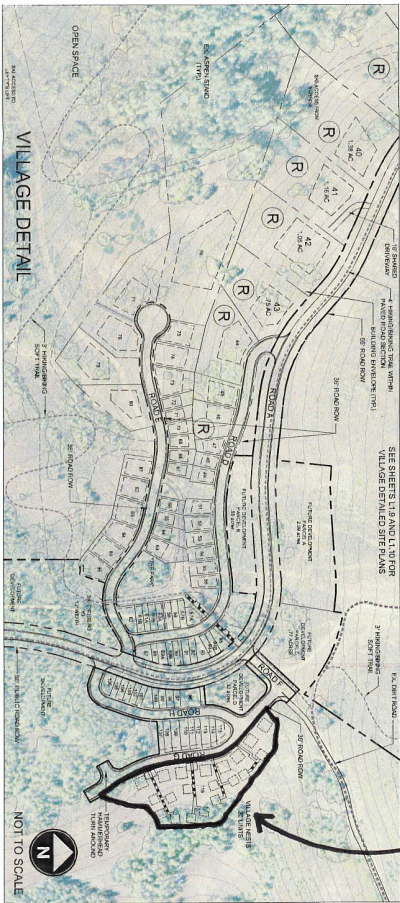

DATE:	MAY 26, 2019
PROJECT:	900200000
DRAWN BY:	EL
REVIEW BY:	PHD
VERSION:	1
REVISIONS:	
SCALE:	AS SHOWN
REVISIONS:	
<b>SHEET TITLE</b>	
OVERALL SITE PLAN	
SHEET NUMBER	
L1.3	



**SUMMIT EDEN**  
 PHASE 1 PRUD SUBMITTAL  
 POWDER MOUNTAIN, WEBER COUNTY, UTAH





Summit Powder Mountain Village is the activity center for the Resort with Main Street retail shops, destination amenities such as lodges, public plazas, recreational facilities and trail heads to access the outdoors. The Summit Powder Mountain Village is modeled after small mountain villages in North American and Europe with walkable, interconnected streets and is made up of boutique hotels, condominiums, townhomes, small single family lots and "nests" making it the most diverse development area at the Resort.

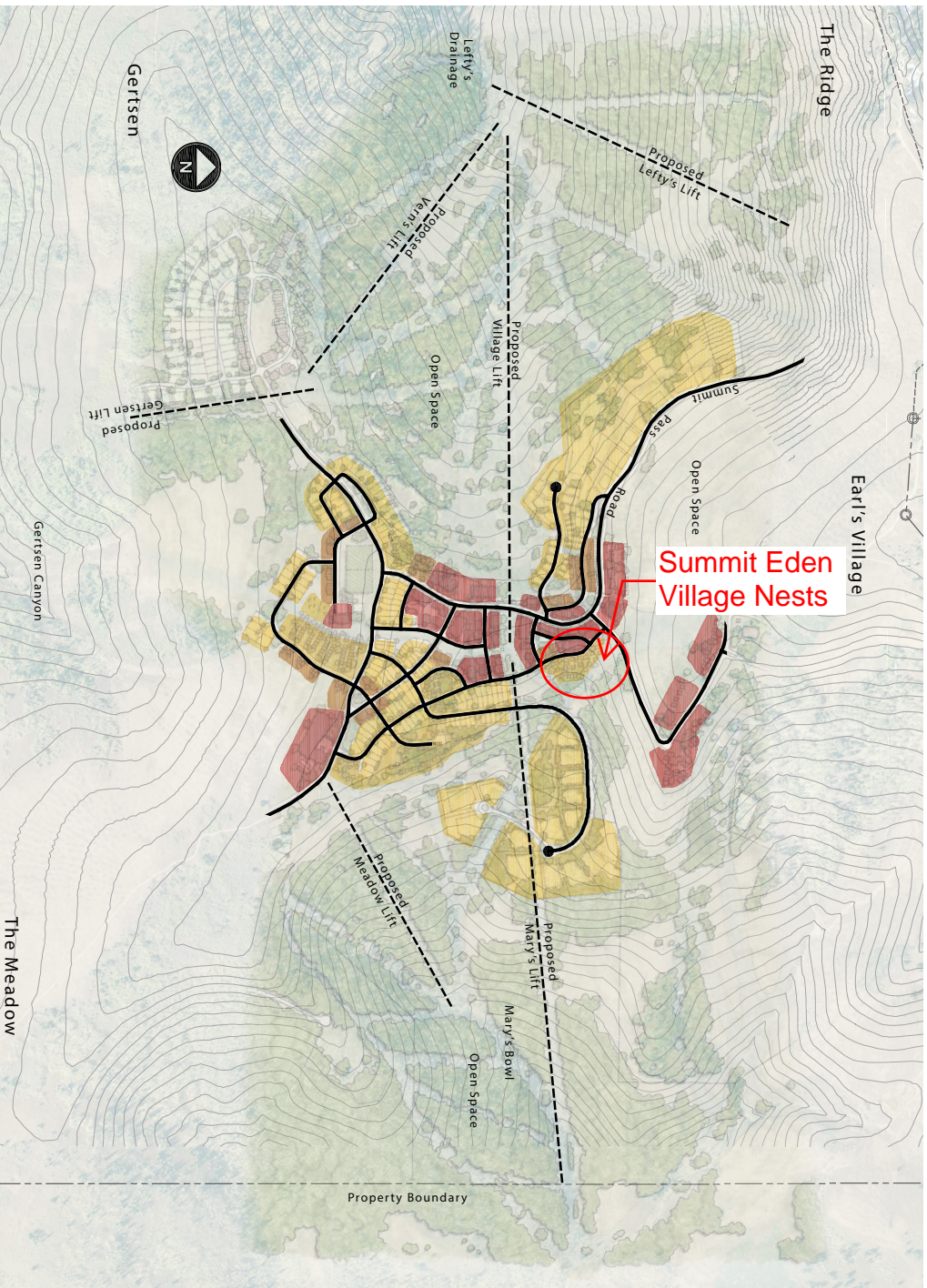

DEVELOPMENT LEGEND	DEVELOPMENT DATA
<span style="display: inline-block; width: 20px; height: 10px; background-color: #e91e63; border: 1px solid black;"></span> MIXED USE	580 ROOMS
<span style="display: inline-block; width: 20px; height: 10px; background-color: #e91e63; border: 1px solid black;"></span> HOTELS	100,000 SF
<span style="display: inline-block; width: 20px; height: 10px; background-color: #e91e63; border: 1px solid black;"></span> COMMERCIAL/SKIER SERVICES	90 ROOMS
<span style="display: inline-block; width: 20px; height: 10px; background-color: #e91e63; border: 1px solid black;"></span> RETREATS	150 UNITS
<span style="display: inline-block; width: 20px; height: 10px; background-color: #e91e63; border: 1px solid black;"></span> MULTI FAMILY	
<span style="display: inline-block; width: 20px; height: 10px; background-color: #fff9c4; border: 1px solid black;"></span> SINGLE FAMILY	268 UNITS
<span style="display: inline-block; width: 20px; height: 10px; background-color: #fff9c4; border: 1px solid black;"></span> SINGLE FAMILY LOTS	186 NESTS

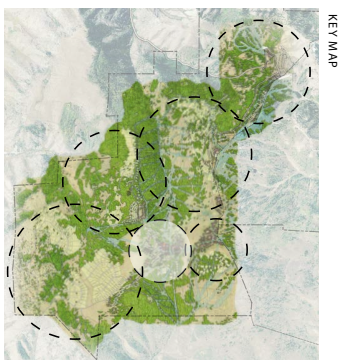





The heart of the Summit Powder Mountain Village is Main Street. Main Street will be comprised of boutique hotels and shops, residential lofts over retail, various lodges and amenities all focused around vibrant pedestrian streets littered with public spaces and access to the abundant outdoors. The Summit Powder Mountain Village was located to provide access to three drainages from its core; East to Mary's Bowl, South to Gertsen Canyon and West to Lecky's while also positioning this diverse development area to be in the least visually sensitive area on the mountain.

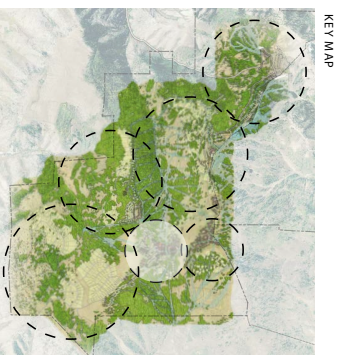

KEY MAP



## Survey Review 1-17-14

**Project** [Summit Eden Village Nests Condominiums](#)  
**User** [Larry Slagowski](#)  
**Department** [Weber County Surveyor's Office](#)  
**Created** 2014-01-17 12:41:46  
**Modified** 2014-01-17 12:41:46  
**Approved** Yes

### Notes

---

Survey office has approved Phase 1D, Development Parcel D (Village Nest) for final approval

## Engineering Review 6

**Project** [Summit Eden Village Nests Condominiums](#)  
**User** [Dana Shuler](#)  
**Department** [Weber County Engineering Division](#)  
**Created** 2014-01-17 08:37:02  
**Modified** 2014-01-17 08:37:02  
**Approved** Yes

### Notes

---

I have had a chance to review the plan(s) and have the following comment(s):

#### General Comments (no response required)

1. Plan approval from DDW is required prior to commencing construction on any water infrastructure (letter from DDW dated 9/11/13 excludes Ridge Nests, Village Nests, and Phase 1E).
2. Open space and common area improvements shall be submitted including but not limited to landscaping, structures, signs, parking, and other amenities.
3. Compaction tests will be required on sub-base, base, and asphalt.
4. All improvements need to be either installed or escrowed for prior to recording of the subdivision.
5. Building permits will be required for the elevated walkway and lift station construction.
6. A plan approval letter from PMWSID is required.
7. Phase 1D will need to be recorded prior to or concurrent to this subdivision.
8. A Weber County Storm Water Construction Activity Permit is required for any construction that:
  1. disturbs more than 5000 square feet of land surface area,
  2. consists of the excavation and/or fill of more than 200 cubic yards of material, or
  3. requires a building permit for which excavation or fill is a part of the construction.
9. A Storm Water Pollution Prevention Plan (SWPPP) is required to be submitted for all new development where construction is required. The State now requires that a Utah Discharge Pollution Elimination Systems (UPDES) permit be acquired for all new development. A copy of the permit needs to be submitted to the County before final approval. Permits can now be obtained online thru the Utah State Department of Environmental Quality at the following web site: <https://secure.utah.gov/swp/client>.

#### Plat comments (no response required):

1. 2014/01/14 version – no comments

#### Improvement Plan set specifics (no response required)

1. A wet stamped copy of the improvement drawings was received 01/09/2014.

#### Escrow Estimate comments (no response required)

1. Version received on 01/02/2014 – no comments  
After all items have been addressed, a wet stamped copy of the improvement drawings will be required.

I have tried to address all items of concern from the Engineering Department. However, this review does not forego other items of concern that may come to this department's attention during additional reviews or during construction of improvements. If you have any comments or questions concerning this review, feel free to contact me.

## Exhibit F

# Weber Fire District Review-3

**Project** [Summit Eden Village Nests Condominiums](#)  
**User** [Brandon Thueson](#)  
**Department** [Weber County Special Events](#), [Weber Fire District](#)  
**Created** 2013-12-03 14:15:13  
**Modified** 2013-12-03 14:16:14  
**Approved** Yes

## Notes

**Date:** December 3, 2013  
**Project Name:** Summit at Powder Mountain Phase  
**ID- Parcel D- Village Nest Condos- Review #3**  
**Project Address:** Daybreak Ridge (New Road)

**Contractor/Contact:** Russ Watts/ NV5

FEE NOTICE: Weber Fire District has various fees associated with plan reviews, and inspections. Please be prepared to make payments at the time of inspections or when you pick up your approved plans. Impact Fees are due prior to taking out a building permit. Make checks payable to: **Weber Fire District**.

**Status:** **APPROVED**

### Specific Comments:

1. It was noted during a review of the resubmitted construction documents that LPG tanks were to be installed to supply the residences with fuel. LPG tank installations are under the jurisdiction of both the Utah State Fire Marshal's office and the Weber Fire District. A plan of the installation must be submitted to the State Fire Marshal's office for review and approval.
2. A deferred submittal will be required for the LPG tanks and piping systems.

Note: The construction documentation was approved, however the LPG tank installation must meet any requirements that Utah State has in addition to the requirements of the International Fire Code, including distances to lot lines, separation distances between tanks, and distances to residential structures.

Every effort has been made to provide a complete and thorough review of these plans. This review DOES NOT relieve the owner, contractor and/or developer from compliance with any and all applicable codes, and standards.

Any change or revision of this plan will render this review void and will require submittal of the new, or revised, layout for fire department review. If you have any questions, please contact me at 801-782-3580.

Brandon Thueson

Fire Marshal

## Property Taxes

<a href="#">Summit Eden Village Nests Condominiums</a>	<b>Project</b>
<a href="#">Carolyn Laird</a>	<b>User</b>
<a href="#">Weber County Treasurer's Office</a>	<b>Department</b>
2013-11-01 14:29:02	<b>Created</b>
2013-11-01 14:29:02	<b>Modified</b>
Yes	<b>Approved</b>

## Notes

Property Taxes for parcel 230120032 have been paid in full through the 2012 Property Tax year. 2013 Property Taxes are due by 12-02-2013.

## Exhibit G

### Findings, Conditions, and Requirements from the April 9, 2013 Staff Report to the Weber County Commission for the Summit at Powder Mountain PRUD

#### Conditions of Approval

The following items must be addressed prior to final subdivision approval:

- Requirements of the Weber County Engineering Division
- Requirements of the Weber Fire District
- Requirements of the Weber-Morgan Health Department
- Requirements of the Weber County Building Inspection Division
- Requirements of the State Division of Drinking Water and Division of Water Quality
- Requirements of Powder Mountain Water and Sewer Improvement District including updated sewer and culinary water feasibility letters
- Sewer capacity assessment letter verifying adequate sewer capacity for the PRUD
- Requirements of the zoning development agreement
- All development parcels must be brought under the same taxing districts
- All delinquent taxes on development parcels must be paid
- Compliance with all applicable county ordinances whether listed in this staff report or not
- Approval of the Cache County units subject to the interlocal agreement or county line adjustment being completed prior to final subdivision approval
- Compliance with Chapter 36-B (Hillside Review) lot size tables

#### Ogden Valley Planning Commission Recommendation

The OVPC unanimously recommended approval of this PRUD on March 19, 2013 subject to several conditions and requirements. The OVPC included the following findings, conditions, and requirements in its recommendation for approval:

OVPC Findings:

- The architectural design of the proposed housing units is acceptable and complies with the PRUD criteria of Chapter 22-D.
- Accessory buildings are not proposed for any of the single-family dwelling lots.
- The landscape plans for the village and nest areas are sufficient and comply with applicable ordinance requirements.
- The units in Cache County are approved subject to an interlocal agreement with Cache County.
- The trails master plan is acceptable subject to the developers providing access and connections to existing trails on the Weber Pathways Ogden Valley Master Plan.
- The road pattern and public/private designations are adequate; however a road maintenance agreement between the developers and Weber County is required.
- Alternative road design elements will require a variance to the Weber County Subdivision Ordinance from the County Commission.
- A secondary access road in Cache County is required.
- The Access Exception application is approved subject to meeting design requirements.
- The restricted lots meet applicable standards.
- The zoning development agreement has been complied with, but the real estate transfer fee must remain at 1.5%.
- Delinquent property taxes on property within the PRUD boundary must be paid prior to final subdivision approval from the County Commission.
- Certification is required from the Summit Eden Design Review Board that each house plan submitted for a building permit complies with their Design Guidelines and the PRUD approval.
- The site plan with 116 lots and 154 units is approved.
- PRUD variations of the FV-3 zoning requirements for lot size, setback, and building heights are approved.
- Time share/nightly rental units shall be designated on the site plan.
- The conference center on Lot 76 is approved as a non-residential accessory use.
- Parking space adjustments from two spaces to one space are allowed for the nest units.
- The conditions of approval in the staff report must be complied with.