

SWPPP for Legacy Mountain

Instructions to the Contractor:

Please familiarize yourself with the SWPPP document and fill in blanks with additional information such as Operator/SWPPP Contact/Stormwater Team names, phone numbers and e-mails, as well as start/end dates, training personnel, inspection schedule, and any other needed information throughout the document. Please submit an NOI and include a copy of the letter from the state notifying you of their receipt of your complete NOI/application in Appendix B. Fill in information in Section 9.2 of this document any time there are revisions to the document. Certifications found in Section 10 are required per Part 9.16.1 of the UCGP. This should be signed by a corporate officer, president, general partner, or similar per Part 9.16.1.a, or a duly authorized representative made in writing. If there are multiple authorized Owners/Operators, please make additional copies of the Certification so that all may sign.

Please place this page in Appendix G after completing the above items.

Storm Water Pollution Prevention Plan

for:

Legacy Mountain
Nighthawk Lane
Near Huntsville City, Utah 84317

Operator:

Company/Organization: _____

Name: _____

Address: _____

Phone: _____

Email: _____

Primary SWPPP Contact

Company/Organization: _____

Name: _____

Address: _____

Phone: _____

Email: _____

Original SWPPP Preparation Individual/Date:

SWPPP originally prepared by Ryan Bingham, P.E. (Civil Engineer) on 1-7-2021

UPDES Permit Tracking Number*:

UTR _____

**This is the unique number assigned to your project after you have applied for coverage under the Utah Pollutant Discharge Elimination System (UPDES) construction general permit. If this template is filled out first, you can leave the tracking number blank until after you have applied for coverage.*

Contents

SECTION 1: CONTACT INFORMATION/ RESPONSIBLE PARTIES	1
1.1 Storm Water Team	1
SECTION 2: NATURE OF CONSTRUCTION ACTIVITIES	2
2.1 Construction Site Estimates	2
2.2 Construction Activity Descriptions	2
2.3 Phase/Sequence of Construction Activity	2
2.4 Maps	2
SECTION 3: WATER QUALITY	3
3.1 Discharge Information	3
3.2 Receiving Waters	3
3.3 Impaired Waters	3
3.4 High Water Quality	3
SECTION 4: POLLUTION PREVENTION STANDARDS	4
4.1 Potential Sources of Pollution	4
4.2 Non-Storm Water Discharges	4
4.3 Dewatering Practices	5
4.4 Natural Buffers or Equivalent Sediment Controls	5
SECTION 5: EROSION AND SEDIMENT CONTROLS – BMPS	8
5.1 List of Erosion and Sediment BMPs on Site	8
5.2 Linear Site Perimeter Control Exemption	9
5.3 Final Stabilization	13
SECTION 6: BMPS - POLLUTION PREVENTION/OPERATIONAL CONTROLS	14
6.1 Spill Prevention and Response	14
6.2 Pollution Prevention Controls	15
SECTION 7: SPECIAL CONDITIONS	20
7.1 Emergency Related Projects	20
7.2 UIC Class 5 Injection Wells	20
7.3 Chemical Treatment	21
SECTION 8: INSPECTIONS & CORRECTIVE ACTIONS	22
8.1 Inspections	22
8.2 Corrective Actions	22
8.3 Delegation of Authority	22
SECTION 9: RECORDKEEPING	23
9.1 Recordkeeping	23
9.2 Log of Changes to the SWPPP	23
SECTION 10: CERTIFICATION	24
Appendix A – Site Maps	
Appendix B – NOI	
Appendix C – Inspection Reports	
Appendix D –Corrective Action Report	
Appendix E – Subcontractor Certifications/Agreements/Delegation of Authority	
Appendix F – Training Logs (CGP Part 6) and Certifications	
Appendix G – Additional Information (i.e., Other permits and out of date SWPPP documents)	
Appendix H – BMP Specifications	
Appendix I – Construction General Permit	

SECTION 1: CONTACT INFORMATION/ RESPONSIBLE PARTIES

1.1 Storm Water Team

Name and/or Position, and Contact	Responsibilities, Qualifications, and Training
Responsible Person: Company Name: Position: Telephone Number: Email:	Responsibility(ies): Qualifications: Training:
Responsible Person: Company Name: Position: Telephone Number: Email:	Responsibility(ies): Qualifications: Training:
Responsible Person: Company Name: Position: Telephone Number: Email:	Responsibility(ies): Qualifications: Training:

SECTION 2: NATURE OF CONSTRUCTION ACTIVITIES

2.1 Construction Site Estimates

The following are estimates for the construction site.

Total project area (lot size):	252.4 acres
Construction site area to be disturbed:	104.1 acres

2.2 Construction Activity Descriptions

Describe the general scope of the work for the project, major phases of construction, etc:
Construction of a new 250± acre residential subdivision will be accomplished with this project. Work will include site grading, underground utilities through the new roadways and storm drainage areas, paved roadways with rolled curb and gutter on each side, and detention ponding areas to serve stormwater.

2.3 Phase/Sequence of Construction Activity

Construction will begin with clearing the roadway portions of the site and stripping the surface. Underground utilities will be constructed, and the roads will be rough graded. The detention ponding areas will be graded and re-shaped as necessary. Surface improvements will follow, which include rolled curb and gutter, asphalt paved roadways, and landscaping on areas that require revegetation as part of the stabilization phase.

2.4 Maps

The General Location Map and Sediment and Erosion Control Plan Map(s) are filed in Appendix A

SECTION 3: WATER QUALITY

3.1 Discharge Information

Does your project/site discharge storm water into a Municipal Separate Storm Sewer System (MS4)? Yes No

List the MS4 that receives the discharge from the construction project: Weber County

3.2 Receiving Waters

Names of Receiving Waters

Name of Receiving Water (first surface water that receives storm water or where storm system discharges to)	Is the water impaired or high quality?	If high quality: Is it Category 1 or 2? If impaired: List pollutants that the waterbody is impaired for
1. Two Unnamed Intermittent Streams flow near the project and receive runoff from the site.	<input type="checkbox"/> Not high quality/impaired <input type="checkbox"/> Impaired, has approved TMDL <input type="checkbox"/> Impaired, no TMDL <input checked="" type="checkbox"/> High quality	Category 1

3.3 Impaired Waters

The above-listed receiving waters are listed as being not impaired.

3.4 High Water Quality

Because this site discharges to surface waters listed as being high water quality, additional precautions must be taken to reduce the probability of releasing pollutants to these surface waters. There are several precautions that can be taken to reduce the risk of discharging pollutants. BMP Material Use may be utilized to ensure fertilizers are not overused and excess is swept onto landscaping or otherwise properly cleaned up. BMP Portable Toilets should be used, ensuring all four corners of each facility are staked to prevent tipping over. Construction Sequencing should be used to limit the footprint of areas disturbed at any one time. This could include limiting disturbed areas to within the ROW and storm drain infrastructure and ponds. Once those areas are stabilized, construction could be allowed for individual lots for prospective and new home owners.

SECTION 4: POLLUTION PREVENTION STANDARDS

4.1 Potential Sources of Pollution

Pollutant-Generating Activity	Pollutants or Pollutant Constituents (that could be discharged if exposed to storm water)	Location on Site (or reference SWPPP site map where this is shown)
Paving	Concrete, Asphalt, Oils	Building and Parking Lot Areas
Solid Waste Storage and Disposal	Garbage/Trash	Staging Area and throughout the site.
Usage and Maintenance of Construction Vehicles	Fuels and Oils	Entire Site
Site Grading	Sediments	Entire Site

4.2 Non-Storm Water Discharges

Check allowable non-storm water discharges that are present and describe the measures used to reduce them or prevent them from contributing pollutants to discharges:

Authorized Non-Storm Water Discharges	Present	Comments/Controls
Discharges from emergency fire-fighting activities	<input type="checkbox"/> Y <input checked="" type="checkbox"/> N	
Fire hydrant flushing	<input checked="" type="checkbox"/> Y <input type="checkbox"/> N	Direct flushed water to settling basin to percolate or evaporate. Do not allow untreated storm water to enter storm drain system.
Properly managed landscape irrigation (excludes fertilizer injector systems)	<input type="checkbox"/> Y <input checked="" type="checkbox"/> N	
Properly managed vehicle and equipment wash water with no soaps, solvents, or detergents	<input checked="" type="checkbox"/> Y <input type="checkbox"/> N	Do not allow discharge of waters if soaps or detergents are used.
Water used to control dust	<input checked="" type="checkbox"/> Y <input type="checkbox"/> N	Utilize appropriate application rate. Do not over-water areas for dust control.
Drinking water, includes uncontaminated water line flushing	<input checked="" type="checkbox"/> Y <input type="checkbox"/> N	Use only uncontaminated water for line flushings, etc.
External building washdown with no soaps, solvents, detergents, or hazardous substances	<input type="checkbox"/> Y <input checked="" type="checkbox"/> N	
Pavement wash waters with no detergents or toxic or hazardous materials. Must have a	<input checked="" type="checkbox"/> Y <input type="checkbox"/> N	Utilize Sediment Trap if pavement washing is used.

sediment basin, sediment trap, of similarly effective control prior to discharge.		
Uncontaminated air conditioning or compressor condensate	<input type="checkbox"/> Y <input checked="" type="checkbox"/> N	
Uncontaminated, non-turbid discharges of ground water (from natural sources) or spring water	<input type="checkbox"/> Y <input checked="" type="checkbox"/> N	
Uncontaminated foundation or footing drains	<input type="checkbox"/> Y <input checked="" type="checkbox"/> N	

4.3 Dewatering Practices

Check box if section not applicable to this site

Describe the general scope of dewatering practices for the project and any BMPs used to manage the dewatering practices:

Utilize only percolation and/or evaporation as a means of release for any water removed as a result of dewatering for water encountered in trenches, foundations, or similar work.

BMP DO: Dewatering Operations

<i>Installation Schedule:</i>	Utilize throughout any activities that are found to require dewatering. Ensure that a dewatering permit is obtained before any dewatering takes place. Insert permit in Appendix G
<i>Maintenance and Inspection:</i>	Inspect BMPs each workday. Be proactive instead of reactive. Repair or replacement to take place upon discovery of the failure of the BMP
<i>Responsible Staff:</i>	Provided by Contractor
<i>Design Specifications and Drawings:</i>	See corresponding BMP details in Appendix H

4.4 Natural Buffers or Equivalent Sediment Controls

Buffer Compliance Alternatives

Are there any surface waters within 50 feet of your project's earth disturbances?

YES NO

List the water body: Two Unnamed Intermittent Streams flow near the project and receive runoff from the site.

Check the compliance alternative that you have chosen:

I will provide and maintain a 50-foot undisturbed natural buffer around the surface water.

It is infeasible to provide and maintain a full 50-foot undisturbed natural buffer. I will provide and implement erosion and sediment controls to achieve the required sediment load reduction for my conditions.

- Reason that a 50' buffer could not be maintained:
- Width of buffer that will be retained: 0
- Additional controls used to achieve equivalent sediment load reduction of a 50' buffer:
- Description of the calculations and assumptions used to determine sediment load reductions:

The project qualifies as “small residential lot” disturbing less than an acre. The natural buffer is preserved in accordance with CGP A.2.3., storm water is treated by site erosion and sediment controls before discharge, natural buffers are shown on the site map, and buffer areas are marked on site. Select one of the 2 alternatives for small residential lots:

Alternative 1: Using Table A-1 in CGP for requirements

- Width of buffer that will be retained:
- Additional controls to be used:

Alternative 2: Using Tables A-2 through A-7 in CGP for requirements

- Width of buffer that will be retained:
- Sediment Risk Level Determined:
- Additional controls to be used:

I qualify for one of the exceptions in Part A.2.2. (If you have checked this box, provide information on the applicable buffer exception that applies, below.)

There is no discharge of storm water through the area between the disturbed portions of the site and the surface water that is located within 50 feet.

No natural buffer exists due to preexisting development disturbances that occurred prior to the initiation of planning for this project.

For a linear project, site constraints (e.g., limited right-of-way) make it infeasible for me to meet any of the compliance alternatives.

- Reason it is infeasible: This project includes a roadway stream crossing.
- Buffer width retained or supplemental controls used: 0 feet retained. Construction of the crossing should occur during the dry season when

the stream is anticipated to be dry. Two layers of silt fence (3 to 5 feet apart) shall be used at this area to reduce potential sediment loads.

Buffer disturbances are authorized under a CWA Section 404 permit.

- Describe earth disturbances in buffer area:

Buffer disturbances will occur for the construction of a water-dependent structure or water access area (e.g., pier, boat ramp, and trail).

- Describe earth disturbances in buffer area:

SECTION 5: EROSION AND SEDIMENT CONTROLS – BMPS

5.1 List of Erosion and Sediment BMPs on Site

CGP Requirement	Example BMPs	EPA SWPPP Guide Section	BMPs Selected (Name and Reference Number if applicable)
Preserve vegetation where possible and direct storm water to vegetated areas when feasible (CGP 2.2.2.)	Phasing to minimize disturbance, signs/fences to protect areas not being disturbed.	Chapter 4, ESC Principle 1	PEV – Preservation of Existing Vegetation.
Install sediment controls along perimeter areas that receive pollutant discharges (CGP 2.2.3.).	Silt fence, fiber rolls, earth berms	Chapter 4, ESC Principle 7	SF – Silt Fence or GB – Gravel Barrier
Minimize sediment track-out (CGP 2.2.4.)	Restrict access, stabilize exits, track-out pads, tire washing station, clean-up sediments	Chapter 4, ESC Principle 9	SCE – Stabilized Construction Entrance
Manage stockpiles with perimeter controls and locate away from storm water conveyances (CGP 2.2.5.)	Sediment barriers downgradient, proper location, covered stockpiles, diverting storm water from stockpiles	Chapter 4, ESC Principle 4	SM – Stockpile Management PC – Plastic Covering
Minimize dust (CGP 2.2.6.)	Water application, mulching, chemical dust suppression techniques		DC – Dust Controls
Minimize steep slope disturbance (CGP 2.2.7.)	Erosion control blankets, tackifiers, protect slopes from disturbance	Chapter 4, ESC Principle 5	PEV – Preservation of Existing Vegetation
Preserve topsoil (CGP 2.2.8.)	Stockpile topsoil	Chapter 4, ESC Principle 1	SM – Stockpile Management
Minimize soil compaction where final cover is vegetation (CGP 2.2.9.)	Restrict vehicle access, recondition soils before seeding		SF – Silt Fence or Other visible barrier may be used to restrict access to these locations
Protect storm drain inlets (CGP 2.2.10.)	Inserts, rock-filled bags, covers	Chapter 4, ESC Principle 6	IP/SB – Inlet Protection Silt Bags IP/GB – Inlet Protection Gravel Bags

Slow down runoff with erosion controls and velocity dissipation devices (CGP 2.2.11.)	Check dams, riprap	Chapter 4, ESC Principle 3	CD – Rock Check Dams
Appropriately design any sediment basins or impoundments (CGP 2.2.12.)	Design to 2-year 24-hour storm or 3,600 cubic feet per acre drained, include design specifications	Chapter 4, ESC Principle 8	DIDM – Detention/Infiltration Device Maintenance
Follow requirements for any treatment chemicals (polymers, flocculants, coagulants, etc.)	Store in leak proof containers and cover, proper training, minimize use		MS – Material Storage
Stabilize exposed portions of site with 14 days of inactivity (CGP 2.2.14).	Seeding, erosion control blankets, gravel, hydromulch	Chapter 9	SP – Seeding and Planting

BMP CS: Construction Sequencing

<i>Installation Schedule:</i>	Utilize during planning stages and follow plan throughout construction.
<i>Maintenance and Inspection:</i>	Modify written plan before any changes in construction activities are initiated.
<i>Responsible Staff:</i>	Provided by Contractor
<i>Design Specifications and Drawings:</i>	See corresponding BMP details in Appendix H

BMP: Detention/Infiltration Device Maintenance

<i>Installation Schedule:</i>	Remove silt after sufficient accumulation. Periodically clean pre-treatment inlets.
<i>Maintenance and Inspection:</i>	May need to utilize this BMP more frequently as required.
<i>Responsible Staff:</i>	Provided by Contractor
<i>Design Specifications and Drawings:</i>	See corresponding BMP details in Appendix H

<i>BMP DC: Dust Controls</i>	
<i>Installation Schedule:</i>	Use regularly as needed to prevent dust from leaving the site in the air.
<i>Maintenance and Inspection:</i>	Daily and as needed, ensure equipment used for dust controls is functioning properly. Inspect site weekly for areas of dust concern, and promptly utilize BMP DC as needed.
<i>Responsible Staff:</i>	Provided by Contractor
<i>Design Specifications and Drawings:</i>	See corresponding BMP details in Appendix H

<i>BMP ET: Employee Training</i>	
<i>Installation Schedule:</i>	Utilize before beginning work and at required intervals throughout project.
<i>Maintenance and Inspection:</i>	Promote clear identification of problems and identify solutions (BMPs). Integrate employee feedback into training and BMP implementation.
<i>Responsible Staff:</i>	Provided by Contractor
<i>Design Specifications and Drawings:</i>	See corresponding BMP details in Appendix H

<i>BMP IDC: Illegal Dumping Controls</i>	
<i>Installation Schedule:</i>	Implement measures to detect, correct, and enforce against illegal dumping of pollutants on streets, and into the storm drain system. Raise public awareness throughout project.
<i>Maintenance and Inspection:</i>	Establish tracking system to identify hot spots, patterns in time of occurrence, mode of dumping, and responsible parties. Look for trends and concentrate efforts accordingly.
<i>Responsible Staff:</i>	Provided by Contractor
<i>Design Specifications and Drawings:</i>	See corresponding BMP details in Appendix H

<i>BMP IP-SB: Silt Bags</i>	
<i>Installation Schedule:</i>	Before work begins upon existing inlets and immediately upon construction of new inlets.
<i>Maintenance and Inspection:</i>	Inspection after all storm events and as required between events.
<i>Responsible Staff:</i>	Provided by Contractor
<i>Design Specifications and Drawings:</i>	See corresponding BMP details in Appendix H

<i>BMP IP-GB: Gravel Bags</i>	
<i>Installation Schedule:</i>	Before work begins upon existing inlets and immediately upon construction of new inlets.
<i>Maintenance and Inspection:</i>	Inspect at least every 14 days and after storm events. Remove accumulated sediment when it reaches ½ bag height. Replace damaged bags and clean up spilled gravel.
<i>Responsible Staff:</i>	Provided by Contractor
<i>Design Specifications and Drawings:</i>	See corresponding BMP details in Appendix H

<i>BMP SS: Street Sweeping</i>	
<i>Installation Schedule:</i>	Utilize throughout construction for existing and new roadway surfaces.
<i>Maintenance and Inspection:</i>	Check streets daily for sediment buildup from construction activity. Sweep when found.
<i>Responsible Staff:</i>	Provided by Contractor
<i>Design Specifications and Drawings:</i>	See corresponding BMP details in Appendix H

<i>BMP PEV: Preservation of Existing Vegetation</i>	
<i>Installation Schedule:</i>	Provide training and strategically placed barriers (to limit construction traffic to essential areas) before construction or earthwork begins, and utilize throughout construction.
<i>Maintenance and Inspection:</i>	Maintenance requirements are low.
<i>Responsible Staff:</i>	Provided by Contractor
<i>Design Specifications and Drawings:</i>	See corresponding BMP details in Appendix H

<i>BMP SP: Seeding and Planting</i>	
<i>Installation Schedule:</i>	Provided by Landscaper
<i>Maintenance and Inspection:</i>	Adequate watering and fertilization shall be used. Grass shall be watered and mowed.
<i>Responsible Staff:</i>	Provided by Contractor
<i>Design Specifications and Drawings:</i>	See corresponding BMP details in Appendix H

<i>BMP SF: Silt Fence</i>	
<i>Installation Schedule:</i>	Install before any soil disturbance occurs.
<i>Maintenance and Inspection:</i>	Inspect immediately after any rainfall. Look for bypassing or undercutting and repair as required. Remove sediment that reaches one-half fence height.
<i>Responsible Staff:</i>	Provided by Contractor
<i>Design Specifications and Drawings:</i>	See corresponding BMP details in Appendix H

<i>BMP SBB: Gravel Barrier</i>	
<i>Installation Schedule:</i>	Install along perimeter of site before any soil disturbance occurs. Use on any areas where silt fence would be impractical, such as any hardscaped areas along the site perimeter.
<i>Maintenance and Inspection:</i>	Inspect immediately after any rainfall and a minimum of once every two weeks. Reshape or replace damaged bags immediately. Remove buildup of sediment.
<i>Responsible Staff:</i>	Provided by Contractor
<i>Design Specifications and Drawings:</i>	See corresponding BMP details in Appendix H

<i>BMP SCE: Stabilized Construction Entrance</i>	
<i>Installation Schedule:</i>	Install before any construction vehicles leave the site
<i>Maintenance and Inspection:</i>	Inspect entrance and adjacent roadway daily for sediment buildup and loss of gravel. Repair as required.
<i>Responsible Staff:</i>	Provided by Contractor
<i>Design Specifications and Drawings:</i>	See corresponding BMP details in Appendix H

<i>BMP SM: Stockpile Management</i>	
<i>Installation Schedule:</i>	Utilize when stockpiles are used. Locate away from drainage courses and inlets.
<i>Maintenance and Inspection:</i>	Conduct regular inspections during and after rainfall events.
<i>Responsible Staff:</i>	Provided by Contractor
<i>Design Specifications and Drawings:</i>	See corresponding BMP details in Appendix H

5.2 *Linear Site Perimeter Control Exemption*

Check box if section not applicable to this site

If the site is linear and perimeter controls are not feasible, describe other practices in use:

5.3 *Final Stabilization*

Description of final stabilization practices and schedule:

Type of stabilization (vegetation/landscaped, graveled, paved, etc.)	Location	Implementation Schedule
Seeding and Planting	See Landscaping Plan	As construction progress allows.
Pavement	Within Right of Ways	Once underground utilities are placed and grading/prep work are completed.

SECTION 6: BMPS - POLLUTION PREVENTION/OPERATIONAL CONTROLS

6.1 Spill Prevention and Response

Describe spill procedures and materials available for expeditious containment, clean-up and disposal of spills:

Keep Rags and/or absorbent material on-site for immediate cleanup and remediation. Do not hose down or bury contaminated soil or material. Utilize landfill or transfer station that is licensed to handle hazardous waste for disposal.

Identify the employee responsible for detection and response of spills and leaks:

Operator listed on NOI is responsible, unless delegated otherwise.

Any discharges in 24 hours equal to or in excess of the reportable quantities listed in 40 CFR 117, 40 CFR 110, and 40 CFR 302 will be reported to the National Response Center and the Division of Water Quality (DWQ) as soon as practical after knowledge of the spill is known to the permittees. The permittee shall submit within 14 calendar days of knowledge of the release a written description of: the release (including the type and estimate of the amount of material released), the date that such release occurred, the circumstances leading to the release, and measures taken and/or planned to be taken to the Division of Water Quality (DWQ), 288 North 1460 West, P.O. Box 144870, Salt Lake City, Utah 84114-4870. The Storm Water Pollution Prevention Plan must be modified within 14 calendar days of knowledge of the release to provide a description of the release, the circumstances leading to the release, and the date of the release. In addition, the plan must be reviewed to identify measures to prevent the reoccurrence of such releases and to respond to such releases, and the plan must be modified where appropriate.

Agency	Phone Number
National Response Center	(800) 424-8802
Division of Water Quality (DWQ) 24-Hr Reporting	(801)-231-1769 (801) 536-4123
Utah Department of Health Emergency Response	(801) 580-6681

Material	Media Released To	Reportable Quantity
Engine oil, fuel, hydraulic & brake fluid	Land	25 gallons
Paints, solvents, thinners	Land	100 lbs (13 gallons)
Engine oil, fuel, hydraulic & brake fluid	Water	Visible Sheen
Antifreeze, battery acid, gasoline, engine degreasers	Air, Land, Water	100 lbs (13 gallons)
Refrigerant	Air	1 lb

6.2 Pollution Prevention Controls

CGP Requirements	Example BMPs	EPA SWPPP Guide Section	BMPs Selected (Name and Reference Number if applicable)
Equipment and vehicle fueling (CGP 2.3.1)	Spill kits, SPCCP, drip pans, locate activities away from conveyances, use secondary containment	Chapter 5, P2 Principle 4	VEC – Vehicle and Equipment Fueling
Equipment and vehicle washing (CGP 2.3.2.)	Locating away from surface waters and storm water conveyances, directing wash waters to a sediment basin or sediment trap, using filtration devices	Chapter 5, P2 Principle 5	VEC – Vehicle and Equipment Cleaning
Storage, handling, and disposal of building products and waste (CGP 2.3.3.)	Cover (plastic sheeting / temporary roofs), secondary containment, leakproof containers, proper dumpsters, secured portable toilets, locate away from storm water conveyances	Chapter 5, P2 Principle 1 and 2	MS – Materials Storage PT – Portable Toilets
Washing of stucco, paint, concrete, form release oils, curing compounds, etc. (CGP 2.3.4.)	Leak proof containers, lined pits, locate away from storm water conveyances	Chapter 5, P2 Principle 3	MU – Material Use SCU – Spill Clean Up
Properly apply fertilizer (CGP 2.3.5)	Follow manufacture specifications, document deviations in applications, avoid applications to frozen ground, before heavy rains, or to storm water conveyances		MU – Material Use

<i>BMP CBC: Catch Basin Cleaning</i>	
<i>Installation Schedule:</i>	Operator/Contractor to utilize during construction while under obligation of the NOI. Owner to utilize throughout the remainder of the life of the storm drain system.
<i>Maintenance and Inspection:</i>	Annual/monthly inspection of public and private facilities to ensure sediment that reaches more than 2 inches in depth is removed. This will help maintain functionality of these facilities.
<i>Responsible Staff:</i>	Provided by Contractor
<i>Design Specifications and Drawings:</i>	See corresponding BMP details in Appendix H

<i>BMP CWM: Concrete Waste Management</i>	
<i>Installation Schedule:</i>	Install before concrete is used onsite.
<i>Maintenance and Inspection:</i>	Inspect subcontractors to ensure concrete wastes are being properly managed. Dispose of hardened concrete on a regular basis. Empty washout before volume exceeds 2/3 of capacity.
<i>Responsible Staff:</i>	Provided by Contractor
<i>Design Specifications and Drawings:</i>	See corresponding BMP details in Appendix H

<i>BMP HWM: Hazardous Waste Management</i>	
<i>Installation Schedule:</i>	Utilize through project, especially during training, waste disposal, and material use.
<i>Maintenance and Inspection:</i>	Inspect hazardous waste receptacles and areas regularly. Arrange for regular hazardous waste collection.
<i>Responsible Staff:</i>	Provided by Contractor
<i>Design Specifications and Drawings:</i>	See corresponding BMP details in Appendix H

<i>BMP MU: Material Use</i>	
<i>Installation Schedule:</i>	Use throughout duration of construction and train personnel before construction materials are used on site.
<i>Maintenance and Inspection:</i>	Use throughout duration of construction and train personnel before construction materials are used on site. Minimize discharges of fertilizers containing nitrogen or phosphorous by selecting alternative, less hazardous materials as much as possible. Do not over apply fertilizers, herbicides, and pesticides. Prepare only amount needed.
<i>Responsible Staff:</i>	Provided by Contractor
<i>Design Specifications and Drawings:</i>	See corresponding BMP details in Appendix H

<i>BMP MS: Materials Storage</i>	
<i>Installation Schedule:</i>	Install before any construction materials are brought to the site.
<i>Maintenance and Inspection:</i>	Utilize throughout construction. Inspect areas daily and repair damage and correct incorrectly stored items.
<i>Responsible Staff:</i>	Provided by Contractor
<i>Design Specifications and Drawings:</i>	See corresponding BMP details in Appendix H

<i>BMP PC: Plastic Covering</i>	
<i>Installation Schedule:</i>	Utilize whenever stockpiles are present.
<i>Maintenance and Inspection:</i>	Inspect daily during construction during the workweek.
<i>Responsible Staff:</i>	Provided by Contractor
<i>Design Specifications and Drawings:</i>	See corresponding BMP details in Appendix H

<i>BMP PT: Portable Toilets</i>	
<i>Installation Schedule:</i>	Locate in convenient locations. Construct as required.
<i>Maintenance and Inspection:</i>	Utilize licensed service with daily observation for leak detection. Arrange for collection with licensed service.
<i>Responsible Staff:</i>	Provided by Contractor
<i>Design Specifications and Drawings:</i>	See corresponding BMP details in Appendix H

<i>BMP SP: Seeding and Planting</i>	
<i>Installation Schedule:</i>	Provided by Contractor
<i>Maintenance and Inspection:</i>	Adequate watering and fertilization shall be used. Grass shall be watered and mowed.
<i>Responsible Staff:</i>	Provided by Contractor
<i>Design Specifications and Drawings:</i>	See corresponding BMP details in Appendix H
<i>BMP SCU: Spill Clean-Up</i>	
<i>Installation Schedule:</i>	Immediately upon spills that may be harmful to receiving waters.
<i>Maintenance and Inspection:</i>	Clean up spills immediately and remediate cause. Document all spills with required data. Contact required authorities for any spill of reportable quantity.
<i>Responsible Staff:</i>	Provided by Contractor
<i>Design Specifications and Drawings:</i>	See corresponding BMP details in Appendix H
<i>BMP SDF: Storm Drain Flushing</i>	
<i>Installation Schedule:</i>	Use for any piping which has or develops a sediment deposit propensity. Utilize schedule that keeps pipes clear of excessive buildup.
<i>Maintenance and Inspection:</i>	When possible, flushed effluent should be collected, decanted, evaporated, and disposed of in a landfill.
<i>Responsible Staff:</i>	Provided by Contractor
<i>Design Specifications and Drawings:</i>	See corresponding BMP details in Appendix H
<i>BMP UOR: Used Oil Recycling</i>	
<i>Installation Schedule:</i>	Implement before any vehicle maintenance occurs on-site.
<i>Maintenance and Inspection:</i>	Contract with a firm specializing in recycling or disposing of this material if necessary. May also be taken to service stations, auto parts retail stores, or landfills.
<i>Responsible Staff:</i>	Provided by Contractor
<i>Design Specifications and Drawings:</i>	See corresponding BMP details in Appendix H

<i>BMP VEC: Vehicle and Equipment Cleaning</i>	
<i>Installation Schedule:</i>	Install Before any construction vehicles leave the site.
<i>Maintenance and Inspection:</i>	Requirements for this BMP are minimal. Some repair may be necessary.
<i>Responsible Staff:</i>	Provided by Contractor
<i>Design Specifications and Drawings:</i>	See corresponding BMP details in Appendix H
<i>BMP VEF: Vehicle and Equipment Fueling</i>	
<i>Installation Schedule:</i>	Install before fuel is brought to the site
<i>Maintenance and Inspection:</i>	Inspect tanks and fueling areas regularly and keep spill cleanup materials onsite.
<i>Responsible Staff:</i>	Provided by Contractor
<i>Design Specifications and Drawings:</i>	See corresponding BMP details in Appendix H
<i>BMP VEMR: Vehicle and Equipment Maintenance & Repair</i>	
<i>Installation Schedule:</i>	Utilize during any equipment or vehicle maintenance that occurs on-site.
<i>Maintenance and Inspection:</i>	Keep equipment clean, don't allow excessive build-up of oil and grease. Inspect equipment for leaks on a regular basis. Check incoming vehicles for leaking oil and fluids. Do not hose down areas, rather use dry sweeping.
<i>Responsible Staff:</i>	Provided by Contractor
<i>Design Specifications and Drawings:</i>	See corresponding BMP details in Appendix H
<i>BMP WHD: Waste Handling and Disposal</i>	
<i>Installation Schedule:</i>	Utilize at all times while construction waste is being generated onsite.
<i>Maintenance and Inspection:</i>	Inspect areas frequently for trash and debris. Ensure site dumpster is available and being used. Arrange for regular collection.
<i>Responsible Staff:</i>	Provided by Contractor
<i>Design Specifications and Drawings:</i>	See corresponding BMP details in Appendix H

SECTION 7: SPECIAL CONDITIONS

7.1 Emergency Related Projects

Emergency-Related Project? Yes No

7.2 UIC Class 5 Injection Wells

Instructions (CGP 7.3.8.):

- If you are using any of the following storm water controls at your site as they are described below, you must document any contact you have had with DWQ for implementing the requirements for underground injection wells in the Safe Drinking Water Act and DEQ’s implementing regulation at UAC R317-7.
- There may be additional local requirements related to such structures
- For the State UIC Contact at DWQ call (801) 536-4300.

Check box if section not applicable to this site

Class V UIC Wells on site (all must be reported to DWQ for inventory):

- Infiltration trenches (if storm water is directed to any shaft or hole that is deeper than its widest surface dimension or has a subsurface fluid distribution system)
- Commercially manufactured pre-cast or pre-built subsurface detention vault/infiltration system
- Drywell, seepage pit, or improved sinkhole (if storm water is directed to any shaft or hole that is deeper than its widest surface dimension or has a subsurface fluid distribution system)

Description of your Class V Injection Well and any local requirements:

Detention ponding areas may be classified as Class V Injection Wells. If this is the case, ensure that the required documentation is supplied to the State for inventory.

Description of any additional BMPs used in conjunction with the UIC well.

BMP: Detention/Infiltration Device Maintenance

<i>Installation Schedule:</i>	Remove silt after sufficient accumulation. Periodically clean pre treatment inlets.
<i>Maintenance and Inspection:</i>	May need to utilize this BMP more frequently as required.
<i>Responsible Staff:</i>	Provided by Contractor
<i>Design Specifications and Drawings:</i>	See corresponding BMP details in Appendix H

7.3 Chemical Treatment

Check box if section not applicable to this site

Soil Types

List all the soil types (including soil types expected to be found in fill material) that are expected to be exposed during construction and that will be discharged to locations where chemicals will be applied:

Treatment Chemicals

List all treatment chemicals that will be used at the site and explain why these chemicals are suited to the soil characteristics:

Describe the dosage of all treatment chemicals you will use at the site or the methodology you will use to determine dosage:

Provide information from any applicable Safety Data Sheets (SDS):

Describe how each of the chemicals will stored:

Include references to applicable state or local requirements affecting the use of treatment chemicals, and copies of applicable manufacturer's specifications regarding the use of your specific treatment chemicals and/or chemical treatment systems:

Special Controls for Cationic Treatment Chemicals (if applicable)

If you have been authorized by DWQ to use cationic treatment chemicals, identify the specific controls and implementation procedures you are required to implement to ensure that your use of cationic treatment chemicals will not lead to a violation of water quality standards or harm aquatic life:

Schematic Drawings of Storm Water Controls/Chemical Treatment Systems

Provide schematic drawings of any chemically-enhanced storm water controls or chemical treatment systems to be used for application of treatment chemicals:

Training

Describe the training that personnel who handle and apply chemicals have received prior to permit coverage, or will receive prior to the use of treatment chemicals:

SECTION 8: INSPECTIONS & CORRECTIVE ACTIONS

8.1 Inspections

Minimum Inspection Schedule Requirements:

Standard Frequency:
<input type="checkbox"/> Once every 7 calendar days.
<input type="checkbox"/> Once every 14 calendar days and within 24 hours of the end of a storm event of 0.5 inches or greater. Rain gauge/weather station used: Contractor to keep rain gauge onsite if this option is chosen.
Increased Frequency (if applicable):
<input type="checkbox"/> <i>Sites discharging to impaired or high-quality waters:</i> Once every 7 calendar days and within 24 hours of the end of a storm event of 0.5 inches or greater.
Decreased Frequency (if applicable):
<input type="checkbox"/> <i>Arid areas:</i> once a month and within 24 hours of a 0.5-inch storm event or greater.
<input type="checkbox"/> <i>Semi-arid areas:</i> once a month and within 24 hours of a 0.5-inch storm event or greater during the dry season:
<input type="checkbox"/> <i>Frozen conditions with work suspended – must have 3 months of continuous expected frozen conditions based on historical averages:</i> no inspections
<input type="checkbox"/> <i>Frozen conditions with continued activities - must have 3 months of continuous expected frozen conditions based on historical averages:</i> once per month
Other:
<input type="checkbox"/> Describe alternative frequency:

Inspection Reports are filed in Appendix C

8.2 Corrective Actions

Correction Action Report is filed in Appendix D.

8.3 Delegation of Authority

See the signed delegation of authority forms (if applicable in Appendix E.)

SECTION 9: RECORDKEEPING

9.1 *Recordkeeping*

Keep a copy of the NOI and Construction General Permit UTRC00000 onsite. Copies of the SWPPP and all reports must be retained for at least three years from the filing of the NOT.

9.2 *Log of Changes to the SWPPP*

Description of the Amendment	Date of Amendment	Amendment Prepared by [Name(s) and Title]

SECTION 10: CERTIFICATION

Owner

I certify under penalty of law that this document and all attachments were prepared under my direction or supervision in accordance with a system designed to assure that qualified personnel properly gathered and evaluated the information submitted. Based on my inquiry of the person or persons who manage the system, or those persons directly responsible for gathering the information, the information submitted is, to the best of my knowledge and belief, true, accurate, and complete. I am aware that there are significant penalties for submitting false information, including the possibility of fine and imprisonment for knowing violations.

Name:

Title:

Signature:

Date:

General Contractor

I certify under penalty of law that this document and all attachments were prepared under my direction or supervision in accordance with a system designed to assure that qualified personnel properly gathered and evaluated the information submitted. Based on my inquiry of the person or persons who manage the system, or those persons directly responsible for gathering the information, the information submitted is, to the best of my knowledge and belief, true, accurate, and complete. I am aware that there are significant penalties for submitting false information, including the possibility of fine and imprisonment for knowing violations.

Name:

Title:

Signature:

Date:

SWPPP APPENDICES

Attach the following documentation to the SWPPP:

Appendix A – Site Maps

Appendix B – NOI

Appendix C – Inspection Reports

Appendix D – Corrective Action Report

***Appendix E – Subcontractor
Certifications/Agreements/Delegation of
Authority (see CGP 9.16(1)b.)***

Appendix F – Training Logs and Certifications (see CGP 6)

***Appendix G – Additional Information (i.e., Other permits such as
dewatering, stream alteration, wetland; and out of
date swppp documents)***

Appendix H – BMP Instruction and Detail Specifications

Appendix I – Construction General Permit

Appendix A: Site Maps

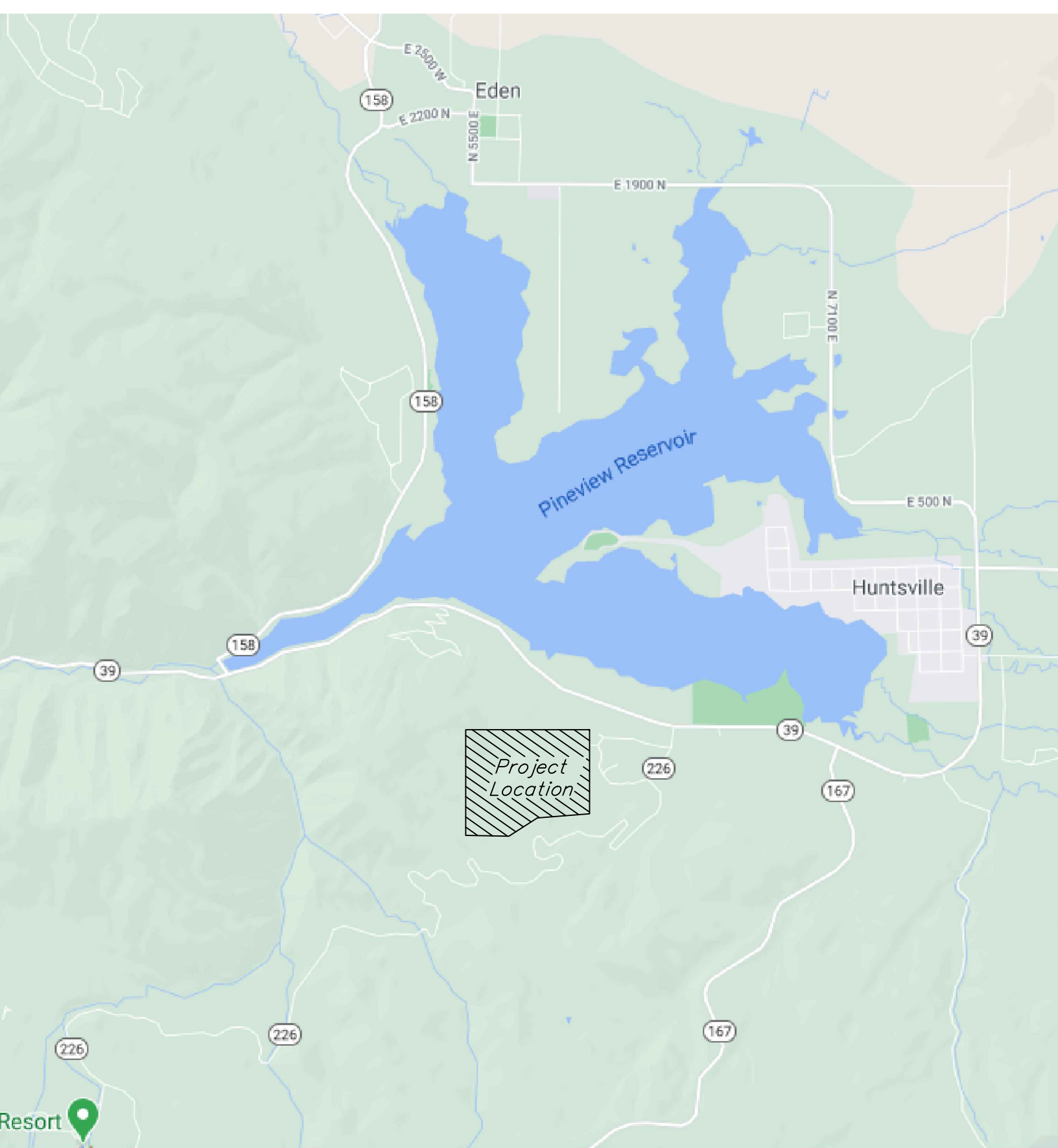

General Location Map

Scale: NTS



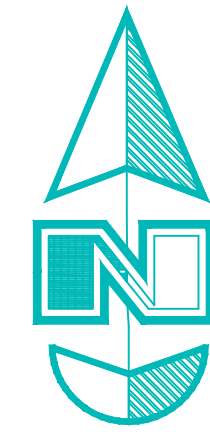

Scale: 1" = 200'

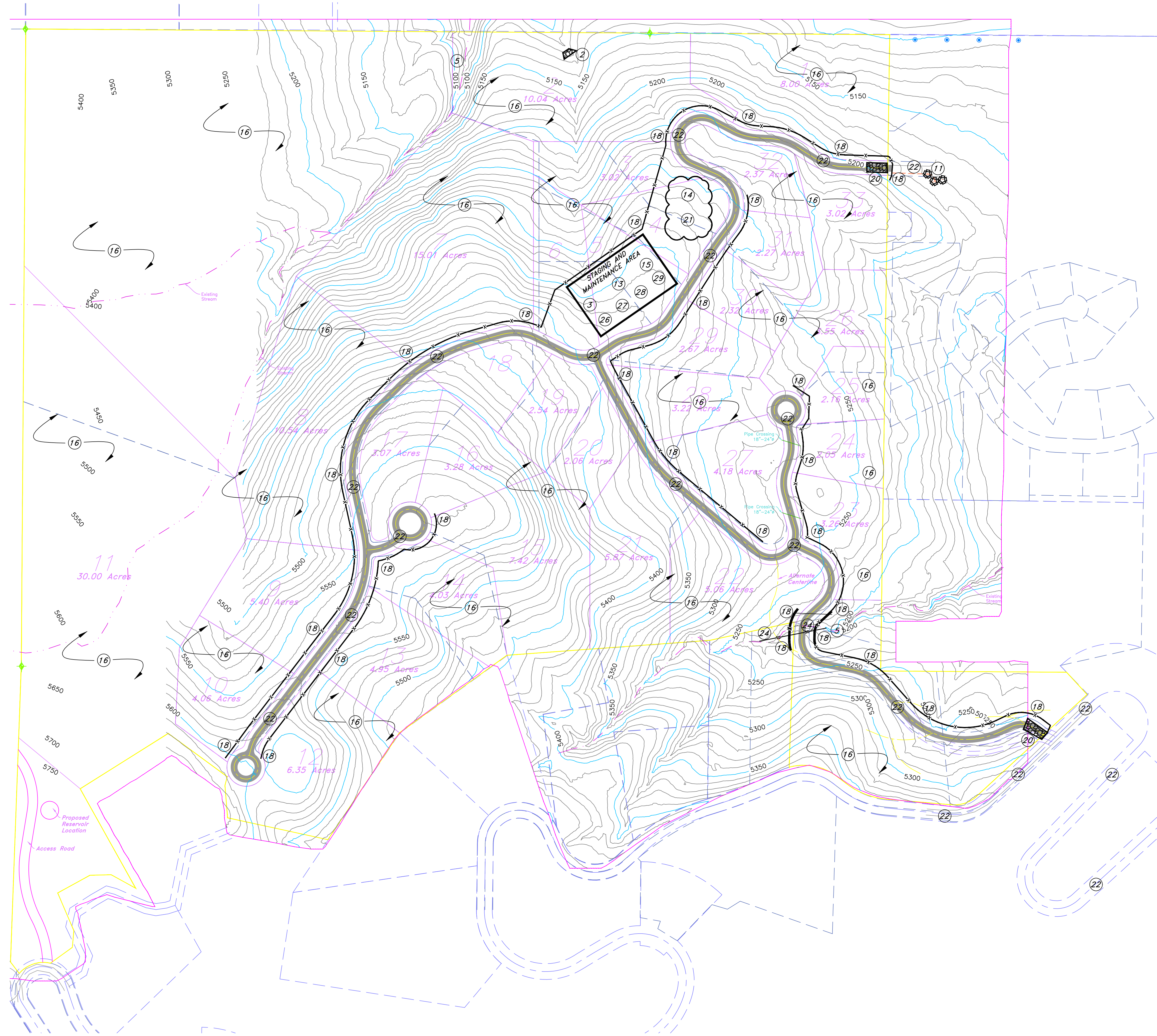
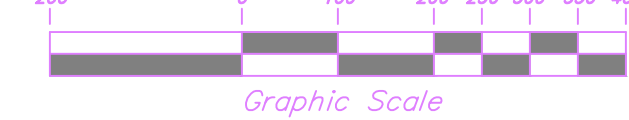

SELECTED BMPs

1. Utilize BMP CBC Catch Basin Cleaning
2. Const. BMP CD Rock Check Dams
3. Utilize BMP CWM Concrete Waste Management
4. Utilize BMP CS Construction Sequencing
5. Utilize BMP DIDM Detention/Infiltration Device Maintenance
6. Utilize BMP DW Dewatering Operations
7. Utilize BMP DC Dust Controls
8. Utilize BMP ET Employee Training
9. Utilize BMP HWM Hazardous Waste Management
10. Const. BMP IDC Illegal Dumping Controls
11. Const. BMP IP Initial Protection (Gravel Bags or Silt Bags are the recommended choice)
12. Utilize BMP MU Material Use
13. Utilize BMP MS Material Storage
14. Const. BMP PC Plastic Covering
15. Const. BMP PT Portable Toilets
16. Utilize BMP PEV Preservation of Existing Vegetation
17. Const. BMP SP Seeding and Planting
18. Const. BMP SF Silt Fence and/or GB Gravel Barrier
19. Utilize BMP SCU Spill Clean-Up
20. Const. BMP SCE Stabilized Construction Entrance
21. Const. BMP SM Stockpile Management
22. Utilize BMP SS Street Sweeping
23. Utilize BMP SDF Storm Drain Flushing
24. Const. BMP TSC Temporary Stream Crossing
25. Utilize BMP UOR Used Oil Recycling
26. Utilize BMP VEC Vehicle and Equipment Cleaning
27. Utilize BMP VEF Vehicle and Equipment Fueling
28. Utilize BMP VEMR Vehicle and Equipment Maintenance & Repair
29. Utilize BMP WHD Waste Handling and Disposal

NOTES:

This sheet constitutes the Sediment and Erosion Control Plan (SECP). This sheet may be included in the improvement drawing plan set for this project, but only as a courtesy. This sheet is most importantly included in the Storm Water Pollution Prevention Plan (SWPPP) for this project. It is located in Appendix A of the SWPPP.

Also note that although the BMP details for the BMPs listed in the SECP may also be included in the improvement drawing plan set as a courtesy, they are most importantly included Appendix H of the SWPPP.

Neither the SECP nor the combination of the SECP along with the BMP details constitutes a SWPPP. Those are only appendices to the SWPPP. The SWPPP for this project was developed using the State Template. A copy of the SWPPP needs to be available while the NOI is active in accordance with Section 7.4.1 (Page 33) of the Utah Construction General Permit (UPDES Permit No. UTRC00000).

Storm Water Pollution Prevention Plan
Existing Conditions
Legacy Mountain

Jan 2021

SHEET NO.

SECP

20N224

GREAT BASIN ENGINEERING

5746 SOUTH 1475 EAST OGDEN, UTAH 84403
 MAIN (801)394-4515 S.L.C (801)521-0222 FAX (801)392-7544
 WWW.GRETBASINENGINEERING.COM

REV DESCRIPTION

Appendix B: NOI

Appendix C: Inspection Reports

Place all completed inspection reports in this appendix. You may also put blank inspection reports here to be completed.

You are encouraged to create your own inspection forms for each site. Inspection reports must have the following information:

- 1) The inspection date.
- 2) The UPDES ID number (UTR_____).
- 3) Name and title of personnel making the inspections.
- 4) Summary of inspection findings and any necessary corrective actions:
 - a. Are storm water controls properly installed and operational? If failed then why?
 - b. Presence of any conditions that could lead to spills or leaks.
 - c. Locations where new or modified controls are necessary.
 - d. Signs of visible erosion or sediment depositing related to your discharges.
 - e. Any incidents of noncompliance.
 - f. Visual quality of any discharges occurring.
- 5) Rainfall amount if the inspection was triggered by a precipitation event.
- 6) If it was unsafe to inspect any areas of the site, a description of the area and reason.

Appendix D: Corrective Action Report

Corrective Action Report

Inspection Date	Inspector Name(s)	Description of BMP Deficiency	Corrective Action Needed (including planned date/responsible person)	Date Action Taken/Responsible person

Appendix E: Subcontractor Certifications/Agreements/Delegation of Authority (CGP 9.16.(1)b.)

A sample subcontractor agreement form and delegation of authority form have been included in this appendix. If these are used, keep complete signed forms here.

SUBCONTRACTOR CERTIFICATION
STORM WATER POLLUTION PREVENTION PLAN

Project Number: _____

Project Title: _____

Operator(s): _____

As a subcontractor, you are required to comply with the Storm water Pollution Prevention Plan (SWPPP) for any work that you perform on-site. Any person or group who violates any condition of the SWPPP may be subject to substantial penalties or loss of contract. You are encouraged to advise each of your employees working on this project of the requirements of the SWPPP. A copy of the SWPPP is available for your review at request.

Each subcontractor engaged in activities at the construction site that could impact storm water must be identified and sign the following certification statement:

I certify under the penalty of law that I have read and understand the terms and conditions of the SWPPP for the above designated project and agree to follow the BMPs and practices described in the SWPPP.

This certification is hereby signed in reference to the above named project:

Company: _____

Address: _____

Telephone Number: _____

Type of construction service to be provided: _____

Signature: _____

Title: _____

Date: _____

Delegation of Authority

I, _____, hereby designate the person or specifically described position below to be a duly authorized representative for the purpose of overseeing compliance with environmental requirements, including the UPDES "General Permit for Storm Water Discharges Associated with Construction Activity" (CGP), at the construction site:

_____, Permit No. UTR _____

The designee is authorized to sign all reports required by the Permit and other information requested by the Director of the Utah Division of Water Quality, or by an authorized representative of the Executive Secretary.

Name of Person or Position: _____

Owner/Operator: _____

Mailing Address: _____

City, State, Zip Code: _____

Phone Number: _____

By signing this authorization, I confirm that I meet the requirements to make such a designation as set forth in Part G.16.1.2. of the CGP, and that the designee above meets the definition of a "duly authorized representative" as set forth in Part G.16.1.2 of the CGP.

I certify under penalty of law that this document and all attachments were prepared under my direction or supervision in accordance with a system designed to assure that qualified personnel properly gather and evaluate the information submitted. Based on my inquiry of the person or persons who manage the system, or those persons directly responsible for gathering the information, the information submitted is, to the best of my knowledge and belief, true, accurate, and complete. I am aware that there are significant penalties for submitting false information, including the possibility of fine and imprisonment for knowing violations.

Name: _____

Title: _____

Signature: _____

Date: _____

Appendix F: Training Logs and Certifications (see CGP 6)

A sample training log has been included in this appendix to keep track of trainings that have been provided. At a minimum, storm water team members that require training should be provided with the following if it relates to their duties (CGP Part 6.3.):

- The permit deadlines associated with installation, maintenance, and removal of storm water controls and with stabilization;
- The location of all storm water controls on the site required by this permit and how they are to be maintained;
- The proper procedures to follow with respect to the permit's pollution prevention requirements; and
- When and how to conduct inspections, record applicable findings, and take corrective actions

Certifications for SWPPP inspectors or writers can also be placed in this appendix.

SWPPP Training Log

Storm Water Pollution Prevention Training Log

Project Name: _____

Project Location: _____

Instructor's Name(s): _____

Instructor's Title(s): _____

Course Location: _____ Date: _____

Course Length (hours): _____

Storm Water Training Topic: *(check as appropriate)*

- Erosion Control BMPs
- Sediment Control BMPs
- Non-Storm Water BMPs
- Emergency Procedures
- Good Housekeeping BMPs

Specific Training Objective: _____

Attendee Roster: *(attach additional pages as necessary)*

No.	Name of Attendee	Company
1		
2		
3		
4		
5		
6		
7		
8		
9		
10		

Appendix G: Additional Information

Use this appendix for additional information such as other permits (dewatering, stream alteration, etc.) or out of date SWPPP documents.

Appendix H: BMP Instruction and Detail Specifications

Use this appendix if complete BMP specifications are not provided in Section 5 or 6 of the SWPPP.

BMP: Catch Basin Cleaning

CBC

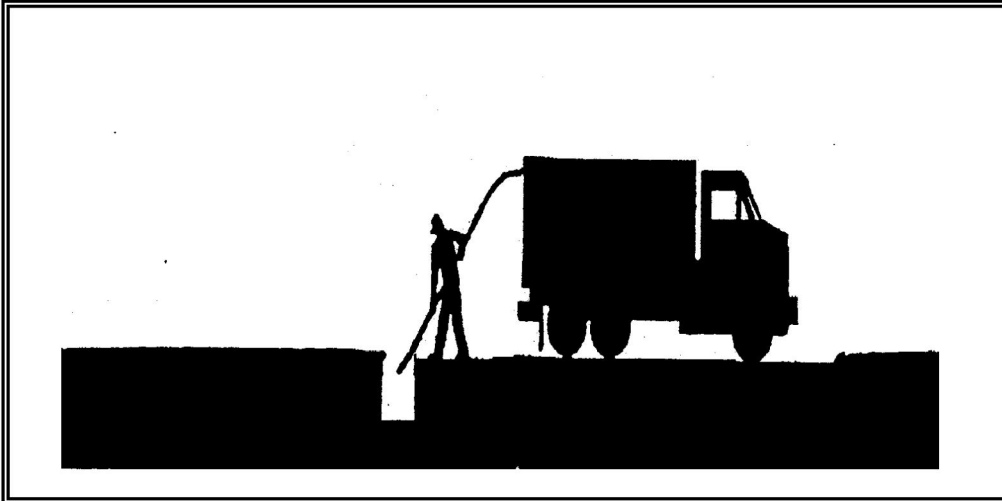

PROGRAM ELEMENTS

- New Development
- Residential
- Commercial Activities
- Industrial Activities
- Municipal Facilities
- Illegal Discharges

DESCRIPTION:

Maintain catch basin and stormwater inlets on a regular basis to remove pollutants, reduce high pollutant concentrations during the first flush of storms, prevent clogging of the downstream conveyance system, and restore the catch basins' sediment trapping capacity. A catch basin is distinguished from a stormwater inlet by having at its base a sediment sump designed to catch and retain sediments below the overflow point. This information sheet focuses on the cleaning of accumulated sediments from catch basins.

APPROACH:

Regular maintenance of catch basins and inlets is necessary to ensure their proper functioning. Clogged catch basins are not only useless but may act as a source of sediments and pollutants. In general, the key to effective catch basins are:

- ▶ At least annual inspections.
- ▶ Prioritize maintenance to clean catch basins and inlets in areas with the highest pollutant loading.
- ▶ Clean catch basins in high pollutant load areas just before the wet season to remove sediments and debris accumulated during the summer.
- ▶ Keep accurate logs of the number of catch basins cleaned.
- ▶ Record the amount of waste collected.

LIMITATIONS:

There are no major limitations to this best management practice.

MAINTENANCE:

Regular maintenance of public and private catch basins and inlets is necessary to ensure their proper functioning. Clogged catch basins are not only useless but may act as a source of sediments and pollutants. In general, the keys to effective catch basins are:

- ▶ Annual/monthly inspection of public and private facilities to ensure structural integrity, a clean sump, and a stenciling of catch basins and inlets.
- ▶ Keep logs of the number of catch basins cleaned.
- ▶ Record the amount of waste collected.

TARGETED POLLUTANTS

- Sediment
- Nutrients
- Heavy Metals
- Toxic Materials
- Oxygen Demanding Substances
- Oil & Grease
- Floatable Materials
- Bacteria & Viruses

- High Impact
- Medium Impact
- Low or Unknown Impact

IMPLEMENTATION REQUIREMENTS

- Capital Costs
- O&M Costs
- Regulatory
- Training
- Staffing
- Administrative

- High
- Medium
- Low

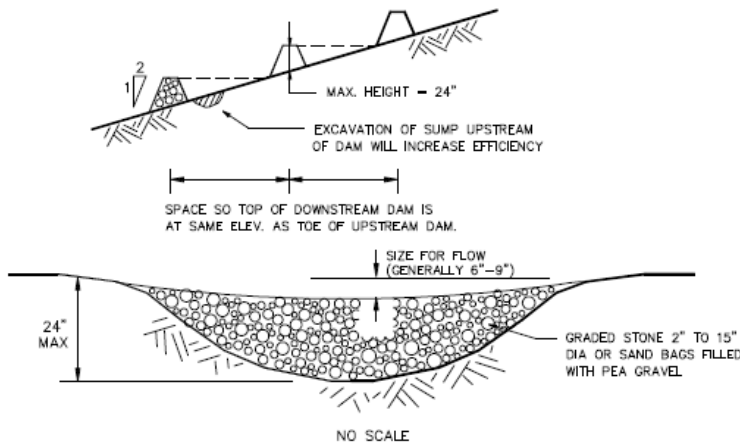

DESCRIPTION:

A small, temporary dam constructed across a drainage ditch to reduce velocity of concentrated storm water flows, thereby reducing the erosion of the ditch.

APPLICATION:

- ▶ Temporary drainage paths
- ▶ Permanent drainage ways not yet stabilized
- ▶ Existing drainage paths receiving increased flows due to construction

INSTALLATION/APPLICATION CRITERIA:

- ▶ Prepare location of dam by removing any debris and rough grading any irregularities in channel bottom
- ▶ Place rocks by hand or with appropriate machinery, do not dump
- ▶ Construct dam with center lower to pass design flow
- ▶ Construct 50% side slopes on dam

LIMITATIONS:

- ▶ Maximum recommended drainage area is 10 acres
- ▶ Maximum recommended height is 24"
- ▶ Do not use in running stream

MAINTENANCE:

- ▶ Inspect dams daily during prolonged rainfall, after each major rain event and at a minimum of once monthly.
- ▶ Remove any large debris and repair any damage to dam, channel or sideslopes
- ▶ Remove accumulated sediment when it reaches one half the height of the dam

OBJECTIVES

- Housekeeping Practices
- Contain Waste
- Minimize Disturbed Areas
- Stabilize Disturbed Areas
- Protect Slopes/Channels
- Control Site Perimeter
- Control Internal Erosion



WEBER COUNTY

ENGINEERING DEPARTMENT

2380 Washington Blvd., Suite 240
Ogden, UT 84401
(801) 399-8374

TARGETED POLLUTANTS

- Sediment
- Nutrients
- Toxic Materials
- Oil & Grease
- Floatable Materials
- Other Waste

- High Impact
- Medium Impact
- Low or Unknown Impact

IMPLEMENTATION REQUIREMENTS

- Capital Costs
- O&M Costs
- Maintenance
- Training

- High
- Medium
- Low

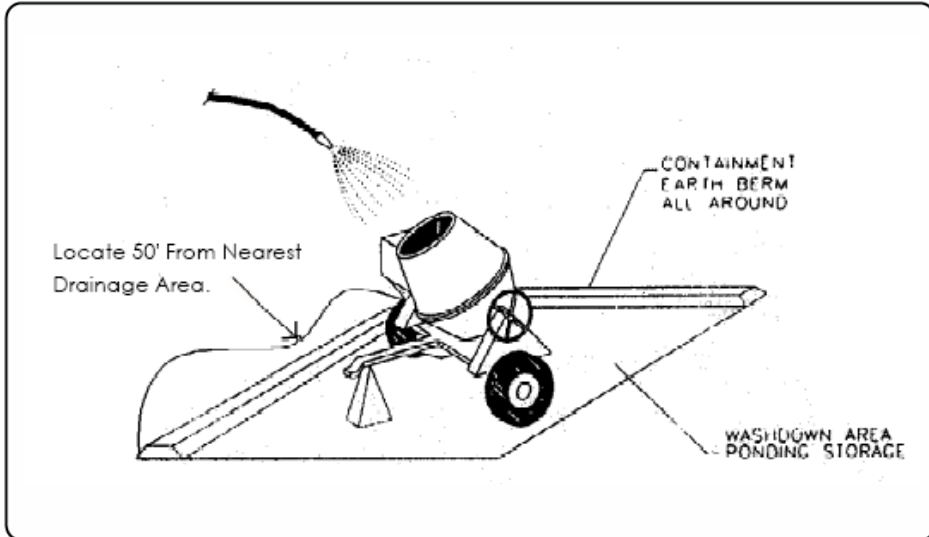

DESCRIPTION:

Prevent or reduce the discharge of pollutants to storm water from concrete waste by conducting washout off-site, performing on-site washout in a designated area, and training employees and subcontractors.

APPLICATIONS:

- ▶ This technique is applicable to all types of sites.

INSTALLATION/APPLICATION CRITERIA:

- ▶ Store dry and wet materials under cover, away from drainage areas.
- ▶ Avoid mixing excess amounts of fresh concrete or cement on-site.
- ▶ Perform washout of concrete trucks off-site or in designated areas only.
- ▶ Do not wash out concrete trucks into storm drains, open ditches, streets, or streams.
- ▶ Do not allow excess concrete to be dumped on-site, except in designated areas.
- ▶ When washing concrete to remove fine particles and expose the aggregate, avoid creating runoff by draining the water within a bermed or level area. (See Earth Berm Barrier information sheet.)
- ▶ Train employees and subcontractors in proper concrete waste management.

LIMITATIONS:

- ▶ Off-site washout of concrete wastes may not always be possible.

MAINTENANCE:

- ▶ Inspect subcontractors to ensure that concrete wastes are being properly managed.
- ▶ If using a temporary pit, dispose hardened concrete on a regular basis.

OBJECTIVES

- Housekeeping Practices
- Contain Waste
- Minimize Disturbed Areas
- Stabilize Disturbed Areas
- Protect Slopes/Channels
- Control Site Perimeter
- Control Internal Erosion



WEBER COUNTY

ENGINEERING DEPARTMENT

2380 Washington Blvd., Suite 240
Ogden, UT 84401
(801) 399-8374

TARGETED POLLUTANTS

- Sediment
- Nutrients
- Toxic Materials
- Oil & Grease
- Floatable Materials
- Other Construction Waste

- High Impact
- Medium Impact
- Low or Unknown Impact

IMPLEMENTATION REQUIREMENTS

- Capital Costs
- O&M Costs
- Maintenance
- Training

- High
- Medium
- Low



In sequenced construction, sites are completed in stages and completed portions are permanently stabilized before other areas are disturbed

DESCRIPTION:

Construction sequencing requires creating and following a work schedule that balances the timing of land disturbance activities and the installation of measures to control erosion and sedimentation, in order to reduce on-site erosion and off-site sedimentation. Staging areas can be used to limit contamination and erosion.

APPROACH:

Construction sequencing can be used to plan earthwork and erosion and sediment control (ESC) activities at sites where land disturbances might affect water quality in a receiving water body.

Construction sequencing schedules should, at a minimum, include the following:

- The ESC practices that are to be installed
- Principal development activities
- Which measures should be installed before other activities are started
- Compatibility with the general contract construction schedule

The following activities and features should be included (as they apply):

- Construction access—entrance to site, construction routes, areas designated for equipment parking
- Sediment traps and barriers—basin traps, sediment fences, outlet protection
- Runoff conveyance system—stabilize stream banks, storm drains, channels, inlet and outlet protection, slope drains
- Land clearing and grading—site preparation (cutting, filling, and grading, sediment traps, barriers, diversions, drains, surface roughening)
- Landscaping and final stabilization—top-soiling, trees and shrubs, permanent seeding, mulching, sodding, riprap

LIMITATIONS:

- Weather and other unpredictable variables may affect construction sequence schedules.

MAINTENANCE:

- The construction sequence should be followed throughout the project and the written plan should be modified before any changes in construction activities are executed.

APPLICATIONS

- Manufacturing
- Material Handling
- Vehicle Maintenance
- Construction
- Commercial Activities
- Roadways
- Waste Containment
- Housekeeping Practices

TARGETED POLLUTANTS

- Sediment
- Nutrients
- Heavy Metals
- Toxic Materials
- Oxygen Demanding Substances
- Oil & Grease
- Floatable Materials
- Bacteria & Viruses

- High Impact
- Medium Impact
- Low or Unknown Impact

IMPLEMENTATION REQUIREMENTS

- Capital Costs
- O&M Costs
- Maintenance
- Training

- High
- Medium
- Low

BMP: Detention/Infiltration Device Maintenance

DIDM

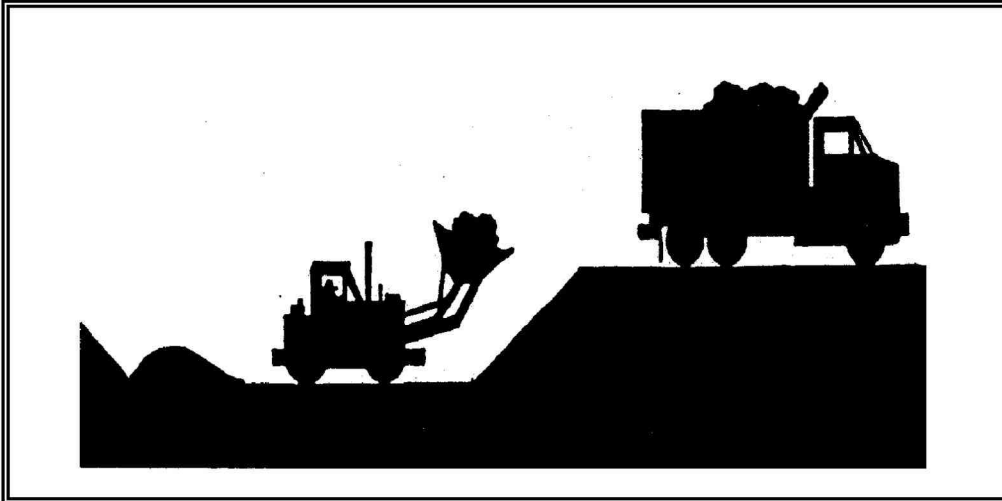

DESCRIPTION:

Proper maintenance and siltation removal is required on both a routine and corrective basis to promote effective storm water pollutant removal efficiencies for wet/dry detention pond and infiltrative devices.

APPROACH:

- ▶ Remove silt after sufficient accumulation.
- ▶ Periodically clean accumulated sediment and silt out of pre-treatment inlets.
- ▶ Infiltration device silt removal should occur when the infiltration rate drops below 1/2 inch per hour.
- ▶ Removal of accumulated paper, trash, and debris should occur every six months or as needed to prevent clogging of control devices.
- ▶ Vegetation growth should not be allowed to exceed 18 inches in height.
- ▶ Mow the slopes periodically and check for clogging, erosion and tree growth on the embankment.
- ▶ Corrective maintenance may require more frequent attention (as required).
- ▶ Create a public education campaign to explain the function of wet/dry detention pond/infiltration devices and their operation requirements for proper effectiveness.
- ▶ Encourage the public to report wet/dry detention pond/infiltration devices needing maintenance.

LIMITATIONS:

- ▶ Wet detention pond dredging can produce slurred waste that often exceeds the requirements of many landfills.
- ▶ Frequent sediment removal is labor and cost intensive.

PROGRAM ELEMENTS

- New Development
- Residential
- Commercial Activities
- Industrial Activities
- Municipal Facilities
- Illegal Discharges

TARGETED POLLUTANTS

- Sediment
- Nutrients
- Heavy Metals
- Toxic Materials
- Oxygen Demanding Substances
- Oil & Grease
- Floatable Materials
- Bacteria & Viruses

- High Impact
- Medium Impact
- Low or Unknown Impact

IMPLEMENTATION REQUIREMENTS

- Capital Costs
- O&M Costs
- Regulatory
- Training
- Staffing
- Administrative

- High Medium Low

Dewatering Operations (DW)

Description

The BMPs selected for construction dewatering vary depending on site-specific features such as soils, topography, anticipated discharge quantities, and discharge location. Dewatering typically involves pumping water from an inundated area to a BMP, and then downstream to a receiving waterway, sediment basin, or well-vegetated area. Dewatering typically involves use of several BMPs in sequence.



Photograph DW-1. A relatively small dewatering operation using straw bales and a dewatering bag.

Appropriate Uses

Dewatering operations are used when an area of the construction site needs to be dewatered as the result of a large storm event, groundwater, or existing ponding conditions. This can occur during deep excavation, utility trenching, and wetland or pond excavation.

Design and Installation

Dewatering techniques will vary depending on site conditions. However, all dewatering discharges must be treated to remove sediment before discharging from the construction site. Discharging water into a sediment trap or basin is an acceptable treatment option. Water may also be treated using a dewatering filter bag, and a series of straw bales or sediment logs. If these previous options are not feasible due to space or the ability to passively treat the discharge to remove sediment, then a settling tank or an active treatment system may need to be utilized. Settling tanks are manufactured tanks with a series of baffles to promote settling. Flocculants can also be added to the tank to induce more rapid settling. This is an approach sometimes used on highly urbanized construction sites. Contact the state agency for special requirements prior to using flocculents and land application techniques.



Photograph DW-2. Dewatering bags used for a relatively large dewatering operation.

Some commonly used methods to handle the pumped water without surface discharge include land application to vegetated areas through a perforated discharge hose (i.e., the "sprinkler method") or dispersal from a water truck for dust control.

Dewatering Operations	
Functions	
Erosion Control	Moderate
Sediment Control	Yes
Site/Material Management	Yes

Dewatering Operations (DW)

Dewatering discharges to non-paved areas must minimize the potential for scour at the discharge point either using a velocity dissipation device or dewatering filter bag.

Design Details are provided for these types of dewatering situations:

DW-1. Dewatering for Pond Already Filled with Water

DW-2 Dewatering Sump for Submersed Pump

DW-3 Sump Discharge Settling Basin

DW-4 Dewatering Filter Bag

Maintenance and Removal

When a sediment basin or trap is used to enable settling of sediment from construction dewatering discharges, inspect the basin for sediment accumulation. Remove sediment prior to the basin or trap reaching half full. Inspect treatment facilities prior to any dewatering activity. If using a sediment control practice such as a sediment trap or basin, complete all maintenance requirements as described in the fact sheets prior to dewatering.

Properly dispose of used dewatering bags, as well as sediment removed from the dewatering BMPs. Depending on the size of the dewatering operation, it may also be necessary to revegetate or otherwise stabilize the area where the dewatering operation was occurring.

Dewatering Operations (DW)

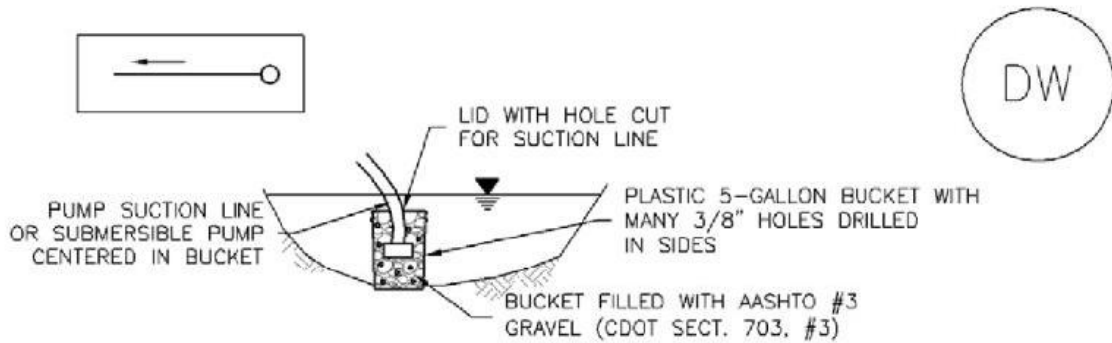

DW-1. DEWATERING POND ALREADY FILLED WITH WATER

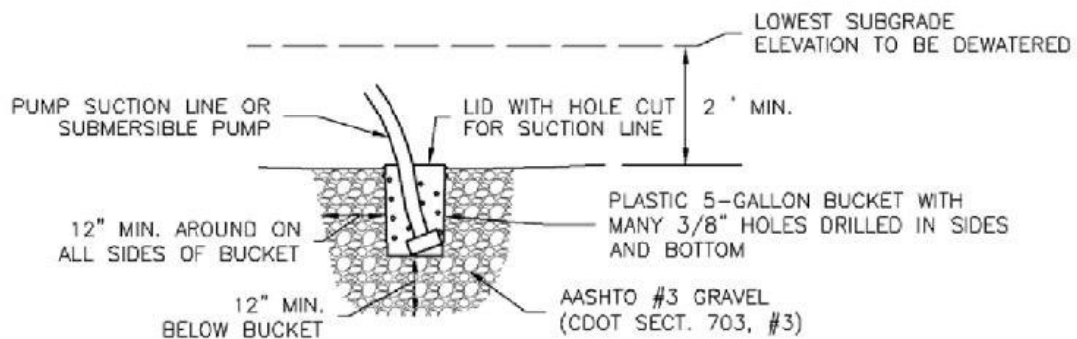

DW-2. DEWATERING SUMP FOR SUBMERSED PUMP

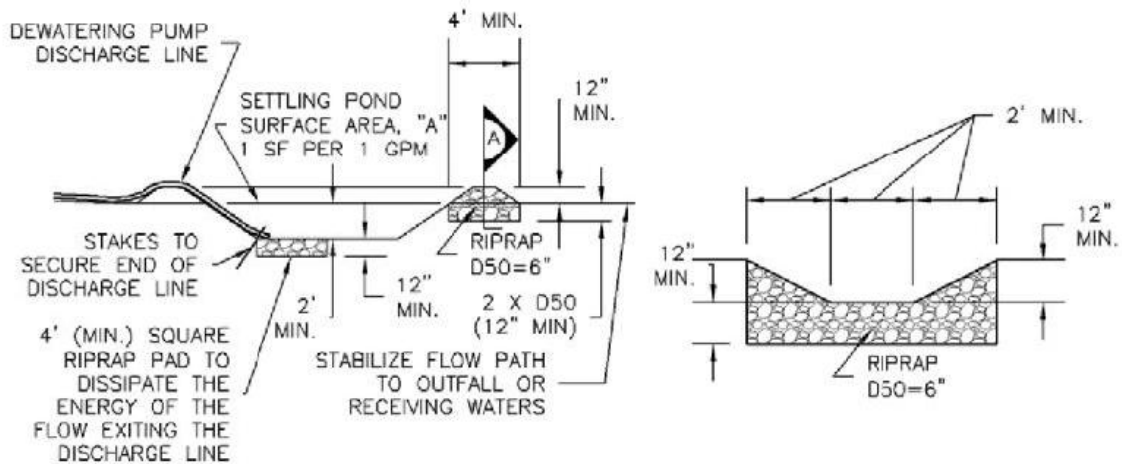

DW-3. SUMP DISCHARGE SETTLING BASIN

SETTLING BASIN SECTION A

Dewatering Operations (DW)

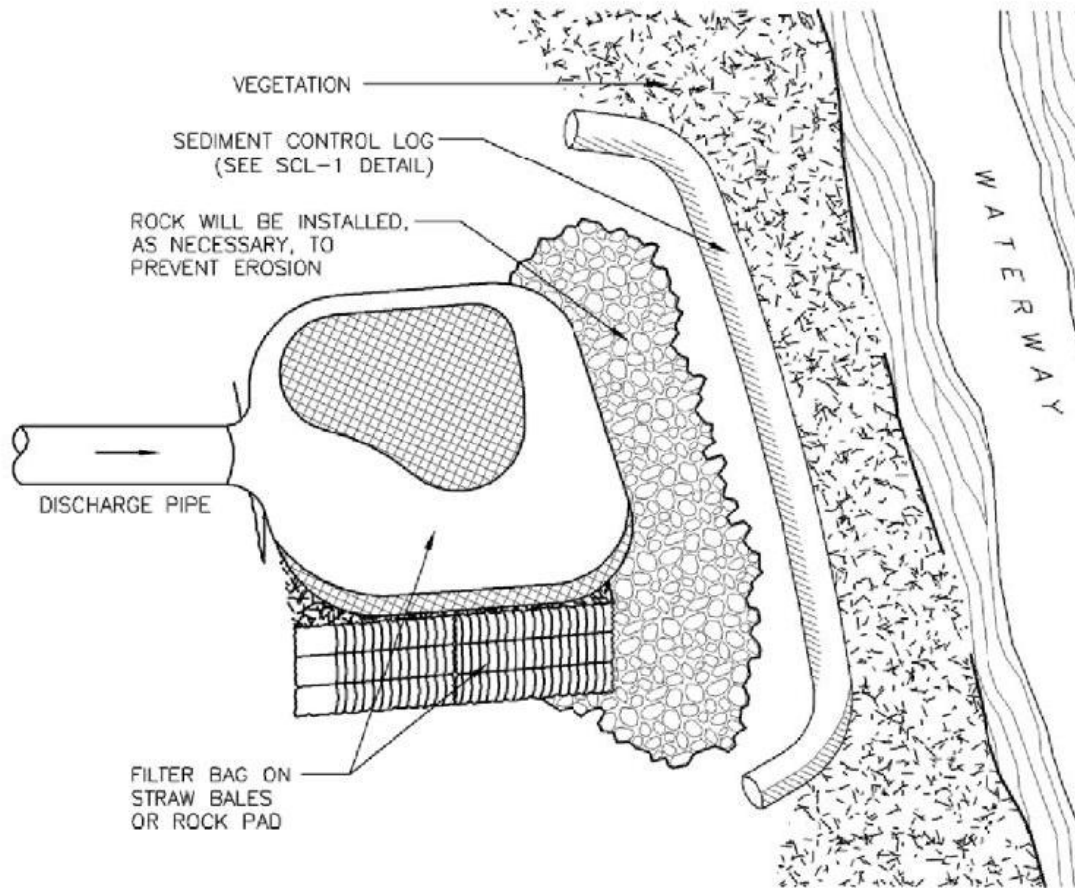

DW-4. DEWATERING FILTER BAG

DEWATERING INSTALLATION NOTES

1. SEE PLAN VIEW FOR;
 - LOCATION OF DEWATERING EQUIPMENT.
 - TYPE OF DEWATERING OPERATION (DW-1 TO DW-4).
2. THE OWNER OR CONTRACTOR SHALL OBTAIN A CONSTRUCTION DISCHARGE (DEWATERING) PERMIT FROM THE STATE PRIOR TO ANY DEWATERING OPERATIONS DISCHARGING FROM THE SITE. ALL DEWATERING SHALL BE IN ACCORDANCE WITH THE REQUIREMENTS OF THE PERMIT.
3. THE OWNER OR OPERATOR SHALL PROVIDE, OPERATE, AND MAINTAIN DEWATERING SYSTEMS OF SUFFICIENT SIZE AND CAPACITY TO PERMIT EXCAVATION AND SUBSEQUENT CONSTRUCTION IN DRY CONDITIONS AND TO LOWER AND MAINTAIN THE GROUNDWATER LEVEL A MINIMUM OF 2-FEET BELOW THE LOWEST POINT OF EXCAVATION AND CONTINUOUSLY MAINTAIN EXCAVATIONS FREE OF WATER UNTIL BACK-FILLED TO FINAL GRADE.

Dewatering Operations (DW)

DEWATERING INSTALLATION NOTES

4. DEWATERING OPERATIONS SHALL USE ONE OR MORE OF THE DEWATERING SUMPS SHOWN ABOVE, WELL POINTS, OR OTHER MEANS APPROVED BY THE LOCAL JURISDICTION TO REDUCE THE PUMPING OF SEDIMENT, AND SHALL PROVIDE A TEMPORARY SEDIMENT BASIN OR FILTRATION BMP TO REDUCE SEDIMENT TO ALLOWABLE LEVELS PRIOR TO RELEASE OFF SITE OR TO A RECEIVING WATER. A SEDIMENT BASIN MAY BE USED IN LIEU OF SUMP DISCHARGE SETTLING BASIN SHOWN ABOVE IF A 4-FOOT-SQUARE RIPRAP PAD IS PLACED AT THE DISCHARGE POINT AND THE DISCHARGE END OF THE LINE IS STAKED IN PLACE TO PREVENT MOVEMENT OF THE LINE.

DEWATERING MAINTENANCE NOTES

1. INSPECT BMPs EACH WORKDAY, AND MAINTAIN THEM IN EFFECTIVE OPERATING CONDITION. MAINTENANCE OF BMPs SHOULD BE PROACTIVE, NOT REACTIVE. INSPECT BMPs AS SOON AS POSSIBLE (AND ALWAYS WITHIN 24 HOURS) FOLLOWING A STORM THAT CAUSES SURFACE EROSION, AND PERFORM NECESSARY MAINTENANCE.

2. FREQUENT OBSERVATIONS AND MAINTENANCE ARE NECESSARY TO MAINTAIN BMPs IN EFFECTIVE OPERATING CONDITION. INSPECTIONS AND CORRECTIVE MEASURES SHOULD BE DOCUMENTED THOROUGHLY.

3. WHERE BMPs HAVE FAILED, REPAIR OR REPLACEMENT SHOULD BE INITIATED UPON DISCOVERY OF THE FAILURE.

4. DEWATERING BMPs ARE REQUIRED IN ADDITION TO ALL OTHER PERMIT REQUIREMENTS.

5. TEMPORARY SETTLING BASINS SHALL BE REMOVED WHEN NO LONGER NEEDED FOR DEWATERING OPERATIONS. ANY DISTURBED AREA SHALL BE COVERED WITH TOPSOIL, SEEDED AND MULCHED OR OTHERWISE STABILIZED IN A MANNER APPROVED BY THE LOCAL JURISDICTION.

NOTE: MANY JURISDICTIONS HAVE BMP DETAILS THAT VARY FROM UDFCD STANDARD DETAILS. CONSULT WITH LOCAL JURISDICTIONS AS TO WHICH DETAIL SHOULD BE USED WHEN DIFFERENCES ARE NOTED.

(DETAILS ADAPTED FROM DOUGLAS COUNTY, COLORADO, NOT AVAILABLE IN AUTOCAD)

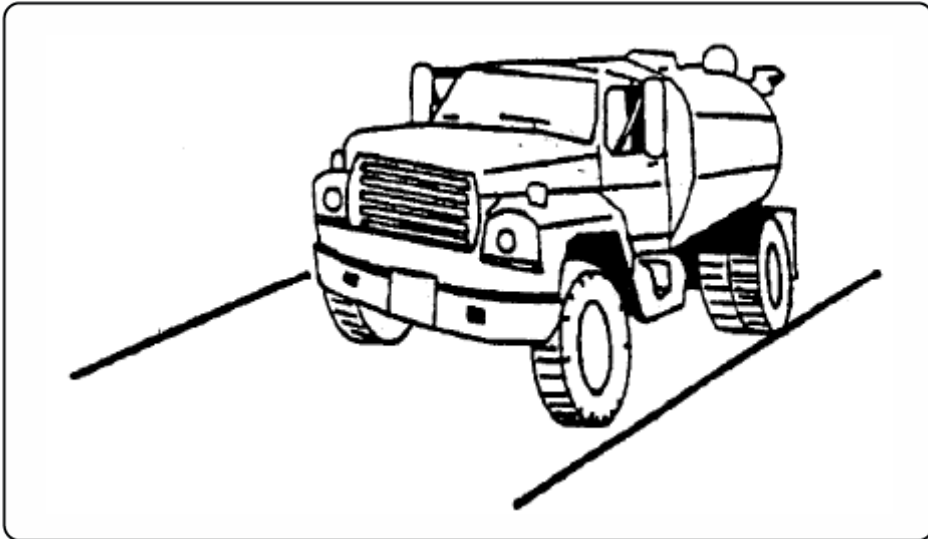

DESCRIPTION:

Dust control measures are used to stabilize soil from wind erosion, and reduce dust by construction activities.

APPLICATION:

- ▶ Dust control is useful in any process area, loading and unloading area, material handling areas, and transfer areas where dust is generated. Street sweeping is limited to areas that are paved.

INSTALLATION/APPLICATION CRITERIA:

- ▶ Mechanical dust collection systems are designed according to the size of dust particles and the amount of air to be processed. Manufacturers' recommendations should be followed for installation (as well as the design of the equipment).
- ▶ Two kinds of street sweepers are common: brush and vacuum. Vacuum sweepers are more efficient and work best when the area is dry.
- ▶ Mechanical equipment should be operated according to the manufacturers' recommendations and should be inspected regularly.

LIMITATIONS:

- ▶ Is generally more expensive than manual systems.
- ▶ May be impossible to maintain by plant personnel (the more elaborate equipment).
- ▶ Is labor and equipment intensive and may not be effective for all pollutants (street sweepers).

MAINTENANCE:

- ▶ If water sprayers are used, dust-contaminated waters should be collected and taken
- ▶ for treatment. Areas will probably need to be resprayed to keep dust from spreading.

OBJECTIVES

- Housekeeping Practices
- Contain Waste
- Minimize Disturbed Areas
- Stabilize Disturbed Areas
- Protect Slopes/Channels
- Control Site Perimeter
- Control Internal Erosion



WEBER COUNTY

ENGINEERING DEPARTMENT

2380 Washington Blvd., Suite 240
Ogden, UT 84401
(801) 399-8374

TARGETED POLLUTANTS

- Sediment
- Nutrients
- Toxic Materials
- Oil & Grease
- Floatable Materials
- Other Waste

- High Impact
- Medium Impact
- Low or Unknown Impact

IMPLEMENTATION REQUIREMENTS

- Capital Costs
- O&M Costs
- Maintenance
- Training

- High
- Medium
- Low

**DESCRIPTION:**

Employee training, like equipment maintenance, is a method by which to implement BMPs. Employee training should be used in conjunction with all other BMPs as part of the facility's SWPPP.

The specific employee training aspects of each of the source controls are highlighted in the individual information sheets. The focus of this information sheet is more general, and includes the overall objectives and approach for assuring employee training in stormwater pollution prevention. Accordingly, the organization of this information sheet differs somewhat from the other information sheets in this chapter.

OBJECTIVES:

Employee training should be based on four objectives:

- ◆ Promote a clear identification and understanding of the problem, including activities with the potential to pollute stormwater;
- ◆ Identify solutions (BMPs);
- ◆ Promote employee ownership of the problems and the solutions; and
- ◆ Integrate employee feedback into training and BMP implementation.

APPROACH:

- ◆ Integrate training regarding stormwater quality management with existing training programs that may be required for your business by other regulations.
- ◆ Businesses that are not regulated in Federal, State, or local regulations, may use the information in this handbook to develop a training program to reduce their potential to pollute stormwater.
- ◆ Employee training is a vital component of many of the individual source control BMPs included in this manual.



HAZARDOUS MATERIAL

DESCRIPTION:

Prevent or reduce the discharge of pollutants to stormwater from hazardous waste through proper material use, waste disposal, and training of employees and subcontractors.

APPLICATION:

Many of the chemicals used on-site can be hazardous materials which become hazardous waste upon disposal. These wastes may include:

- ▶ Paints and solvents; petroleum products such as oils; fuels and greases; herbicides and pesticides; acids for cleaning masonry; and concrete curing compounds.

In addition, sites with existing structures may contain wastes which must be disposed of in accordance with federal, state and local regulations, including:

- ▶ Sandblasting grit mixed with lead, cadmium or chromium based paints, asbestos, and PCBs.

INSTALLATION/APPLICATION CRITERIA:

The following steps will help reduce stormwater pollution from hazardous wastes:

- ▶ Use the entire product before disposing of the container.
- ▶ Do not remove the original product label; it contains important safety and disposal information.
- ▶ Do not over-apply herbicides and pesticides. Prepare only the amount needed. Follow the recommended usage instructions. Over-application is expensive and environmentally harmful. Apply surface dressings in several smaller applications, as opposed to one large application, to allow time for infiltration and to avoid excess material being carried off-site by runoff. Do not apply these chemicals just before it rains. People applying pesticides must be certified in accordance with federal and state regulations.

LIMITATIONS:

- ▶ Hazardous waste that cannot be reused or recycled must be disposed of by a licensed hazardous waste collector.

MAINTENANCE:

- ▶ Inspect hazardous waste receptacles and areas regularly.
- ▶ Arrange for regular hazardous waste collection.

OBJECTIVES

- New Development
- Residential
- Commercial Activities
- Industrial Activities
- Municipal Facilities
- Illegal Discharges



WEBER COUNTY

ENGINEERING DEPARTMENT

2380 Washington Blvd., Suite 240
Ogden, UT 84401
(801) 399-8374

TARGETED POLLUTANTS

- Sediment
- Nutrients
- Heavy Metals
- Toxic Materials
- Oxygen Demanding Substance
- Oil & Grease
- Floatable Materials
- Bacteria & Viruses
- High Impact
- Medium Impact
- Low or Unknown Impact

IMPLEMENTATION REQUIREMENTS

- Capital Costs
- O&M Costs
- Regulatory
- Training
- Staffing
- Administrative
- High
- Medium
- Low

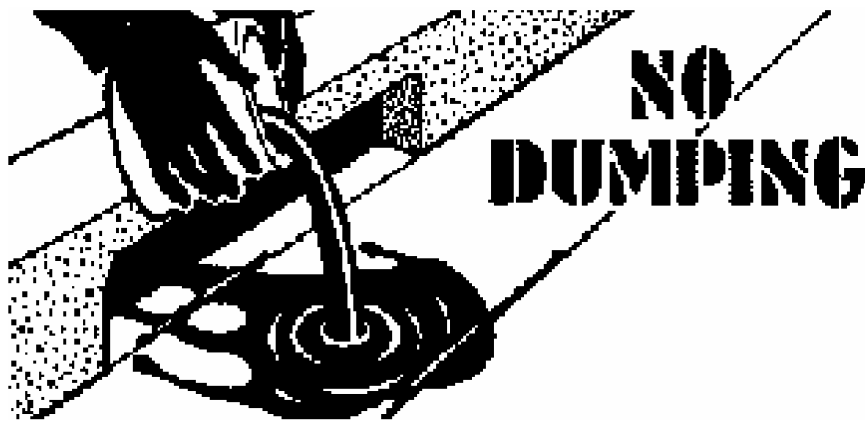

PROGRAM ELEMENTS

- New Development
- Residential
- Commercial Activities
- Industrial Activities
- Municipal Facilities
- Illegal Discharges

DESCRIPTION:

Implement measures to detect, correct, and enforce against illegal dumping of pollutants on streets, into the storm drain system, and into creeks. Substances illegally dumped on streets, into the storm drain system, and into creeks includes paints, used oil and other automotive fluids, construction debris, chemicals, fresh concrete, leaves, grass clippings, and pet wastes. All of these wastes can cause storm water and receiving water quality problems as well as clog the storm drain system.

APPROACH:

One of the keys to success is increasing the general public's awareness of the problem and to at least identify the incident, if not correct it. There are a number of ways of accomplishing this:

- ▶ Train municipal staff from all departments to recognize and report incidents.
- ▶ Deputize municipal staff who may come into contact with illegal dumping with the authority to write illegal dumping tickets for offenders caught in the act.
- ▶ Educate the public.
- ▶ Provide the public with a mechanism for reporting such as a hot line.

Establish system for tracking incidents which will identify:

- ▶ Illegal dumping "hot spots",
- ▶ Types and quantities (in some cases) of wastes,
- ▶ Patterns in time of occurrence (time of day/night, month, or year),
- ▶ Mode of dumping (abandoned containers, "midnight dumping" from moving vehicles, direct dumping of materials, accident/spills), and
- ▶ Responsible parties.

A tracking system also helps manage the program by indicating trends, and identifying who, what, when, and where efforts should be concentrated.

LIMITATIONS

The elimination of illegal dumping is dependent on the availability, convenience, and cost of alternative means of disposal.

TARGETED POLLUTANTS

- Sediment
- Nutrients
- Heavy Metals
- Toxic Materials
- Oxygen Demanding Substances
- Oil & Grease
- Floatable Materials
- Bacteria & Viruses

- High Impact
- Medium Impact
- Low or Unknown Impact

IMPLEMENTATION REQUIREMENTS

- Capital Costs
- O&M Costs
- Regulatory
- Training
- Staffing
- Administrative

- High Medium Low

BMP: Inlet Protection - Gravel Bags

IP-GB

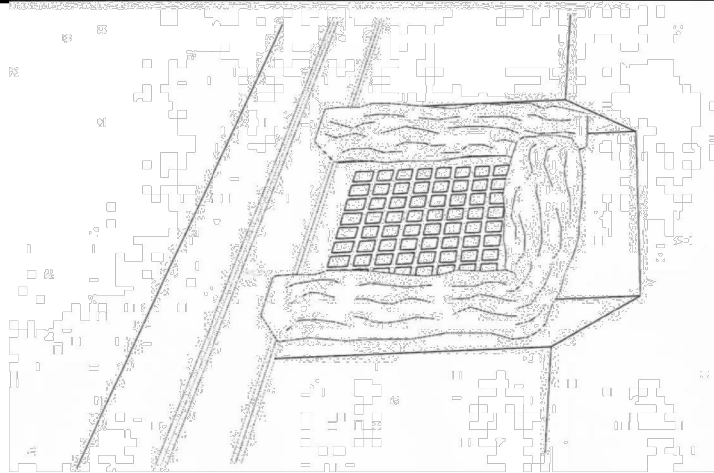

OBJECTIVES

- Housekeeping Practices
- Contain Waste
- Minimize Disturbed Areas
- Stabilize Disturbed Areas
- Protect Slopes/Channels
- Control Site Perimeter
- Control Internal Erosion

TARGETED POLLUTANTS

H M L

- Sediment
- Nutrients
- Heavy Metals
- Toxic Materials
- Oil & Grease
- Floatable Materials
- Bacteria & Viruses
- Other Waste

IMPLEMENTATION REQUIREMENTS

H M L

- Capital Costs
- O&M Costs
- Maintenance
- Training
- Staffing
- Administrative

H = High M = Medium L = Low

DESCRIPTION:

Sediment barrier erected around storm drain inlet.

APPLICATION:

Construct at storm drainage inlets located down-gradient of areas to be disturbed by construction

INSTALLATION / APPLICATION CRITERIA:

- Provide up-gradient sediment controls, such as silt fence during construction of inlet
- When construction of curb and gutter and roadway is complete, install gravel filled bags around perimeter of inlet
- Fill to recommended levels to reduce splitting of bags

LIMITATIONS:

- Recommended maximum contributing drainage area of one acre
- Requires shallow sloped adjacent to inlet.

MAINTENANCE:

- Inspect inlet protection following storm event and at a minimum of once every 14 days.
- Remove accumulated sediment when it reaches half the height of the bag.
- Look for bypassing or undercutting and repair or realign as needed.
- Replace and clean up spilled gravel when bags split.

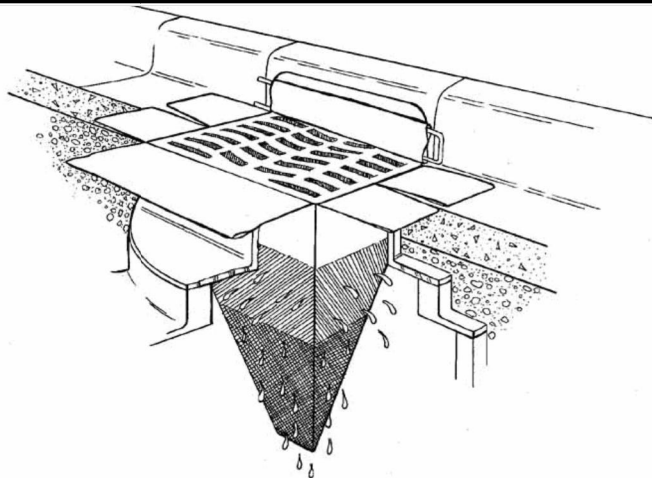

DESCRIPTION:

Collect and trap sediment and debris entering catch basins from either grated or curb inlets. Insert is made of fabric and is placed in the drain inlet around the perimeter of the grate. Runoff passes through the bag before discharging into the drain outlet pipe. Overflow holes are usually provided to pass larger flows without causing a backwater at the grate. Certain manufactured products include polymers intended to increase pollutant removal effectiveness.

APPLICATIONS:

- Storm drain inlet boxes

INSTALLATION / APPLICATION CRITERIA:

- Regular Maintenance is necessary
- Evaluation of the device chosen should be balanced with cost
- Hydraulic capacity controls effectiveness
- Most useful in small drainage areas (< 1 Acre)
- Ideal in combination with other BMP's

LIMITATIONS:

- Cost
- Maintenance required to prevent plugging and remain effective

MAINTENANCE:

Inspection after all storm events and as required between events

OBJECTIVES

- Housekeeping Practices
- Contain Waste
- Minimize Disturbed Areas
- Stabilize Disturbed Areas
- Protect Slopes/Channels
- Control Site Perimeter
- Control Internal Erosion

TARGETED POLLUTANTS

H M L

- Sediment
- Nutrients
- Heavy Metals
- Toxic Materials
- Oil & Grease
- Floatable Materials
- Bacteria & Viruses
- Other Waste

IMPLEMENTATION REQUIREMENTS

H M L

- Capital Costs
- O&M Costs
- Maintenance
- Training
- Staffing
- Administrative

H = High M = Medium L = Low



DESCRIPTION:

Prevent or reduce the discharge of pollutants to storm water from material use by using alternative products, minimizing hazardous material use on-site, and training employees and subcontractors.

APPLICATION:

The following materials are commonly used on construction sites:

- ▶ Pesticides and herbicides, fertilizers, detergents, plaster and other products, petroleum products such as fuel, oil, and grease.
- ▶ Other hazardous chemicals such as acids, lime, glues, paints, solvents, and curing compounds.

INSTALLATION/APPLICATION CRITERIA:

- ▶ Use less hazardous, alternative materials as much as possible.
- ▶ Minimize use of hazardous materials on-site.
- ▶ Use only materials where and when needed to complete the construction activity.
- ▶ Follow manufacturer's instructions regarding uses, protective equipment, ventilation, flammability, and mixing of chemicals.
- ▶ Personnel who use pesticides should be trained in their use.
- ▶ Do not over apply fertilizers, herbicides, and pesticides. Prepare only the amount needed.
- ▶ Unless on steep slopes, till fertilizers in to the soil rather than hydroseeding.
- ▶ Do not apply these chemicals just before it rains.

LIMITATIONS:

- ▶ Alternative materials may not be available, suitable, or effective in every case.

MAINTENANCE:

- ▶ Maintenance of this best management practice is minimal.

OBJECTIVES

- Housekeeping Practices
- Contain Waste
- Minimize Disturbed Areas
- Stabilize Disturbed Areas
- Protect Slopes/Channels
- Control Site Perimeter
- Control Internal Erosion



WEBER COUNTY

ENGINEERING DEPARTMENT

2380 Washington Blvd., Suite 240
Ogden, UT 84401
(801) 399-8374

TARGETED POLLUTANTS

- Sediment
- Nutrients
- Toxic Materials
- Oil & Grease
- Floatable Materials
- Other Construction Waste

- High Impact
- Medium Impact
- Low or Unknown Impact

IMPLEMENTATION REQUIREMENTS

- Capital Costs
- O&M Costs
- Maintenance
- Training

- High
- Medium
- Low

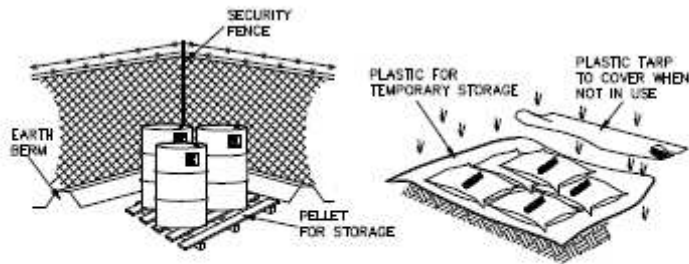

- ▶ CONTROLLED STORAGE LOCATION
- ▶ BERMED PERIMETER IMPOUNDMENT
- ▶ STORAGE OFF GROUND
- ▶ COVER WHEN NOT IN USE

DESCRIPTION:

Controlled storage of on-site materials.

APPLICATION:

- ▶ Storage of hazardous, toxic, and all chemical substances.
- ▶ Any construction site with outside storage of materials.

INSTALLATION/APPLICATION CRITERIA:

- ▶ Designate a secured area with limited access as the storage location. Ensure no waterways or drainage paths are nearby.
- ▶ Construct compacted earthen berm (See Earth Berm Barrier Information Sheet), or similar perimeter containment around storage location for impoundment in the case of spills.
- ▶ Ensure all on-site personnel utilize designated storage area. Do not store excessive amounts of material that will not be utilized on site.
- ▶ For active use of materials away from the storage area ensure materials are not set directly on the ground and are covered when not in use. Protect storm drainage during use.

LIMITATIONS:

- ▶ Does not prevent contamination due to mishandling of products.
- ▶ Spill Prevention and Response Plan still required.
- ▶ Only effective if materials are actively stored in controlled location.

MAINTENANCE:

- ▶ Inspect daily and repair any damage to perimeter impoundment or security fencing.
- ▶ Check materials are being correctly stored (i.e. standing upright, in labeled containers, tightly capped) and that no materials are being stored away from the designated location.

OBJECTIVES

- Housekeeping Practices
- Contain Waste
- Minimize Disturbed Areas
- Stabilize Disturbed Areas
- Protect Slopes/Channels
- Control Site Perimeter
- Control Internal Erosion



WEBER COUNTY

ENGINEERING DEPARTMENT

2380 Washington Blvd., Suite 240
Ogden, UT 84401
(801) 399-8374

TARGETED POLLUTANTS

- Sediment
- Nutrients
- Toxic Materials
- Oil & Grease
- Floatable Materials
- Other Construction Waste

- High Impact
- Medium Impact
- Low or Unknown Impact

IMPLEMENTATION REQUIREMENTS

- Capital Costs
- O&M Costs
- Maintenance
- Training

- High
- Medium
- Low

BMP PC

PLASTIC COVERING



DESCRIPTION

Plastic covering is used to cover exposed areas, which need immediate protection from erosion.

PURPOSE

The purpose of this BMP includes, but is not limited to:

- Providing immediate temporary erosion protection to slopes, piles and disturbed areas that cannot be covered by mulching.
- Protecting exposed surfaces from water and/or wind erosion.
- Used in winter months as a temporary erosive control device when grass seed will not germinate.

APPLICATIONS

This BMP may be used in disturbed areas, which require immediate erosion protection, areas seeded during winter and spring to aid in germination and for protection from heavy rain. Plastic covering may be used on steep slopes, construction sites and on stockpiles and/or excess materials. It may be used in combination with other BMPs.

LIMITATIONS

This BMP should not be used:

- For long term erosion control.
- Without controlling surface water runoff from the plastic covered area.

CONSTRUCTION GUIDELINES

- Plastic must be secured by staking or using weight (i.e. sandbag or tires) to prevent movement. Rebar must not be used as a staking mechanism.
- Plastic covering must be "keyed" in at the top of the slope.
- Additional BMPs, such as a berm and/or sediment control, must be used to control surface water runoff from plastic.

BMP MAINTENANCE

- During construction, inspect BMPs daily during the workweek.

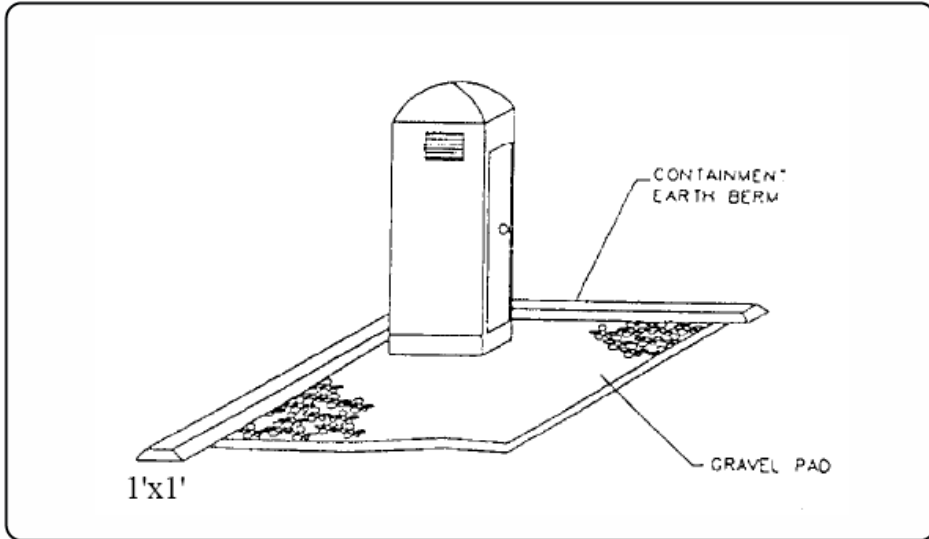

DESCRIPTION:

Temporary on-site sanitary facilities for construction personnel.

APPLICATION:

- ▶ All sites with no permanent sanitary facilities or where permanent facility is too far from activities.

INSTALLATION/APPLICATION CRITERIA:

- ▶ Locate portable toilets in convenient locations throughout the site.
- ▶ Prepare level, gravel surface and provide clear access to the toilets for servicing and for on-site personnel.
- ▶ Construct earth berm perimeter (See Earth Berm Barrier Information Sheet), control for spill/protection leak.

LIMITATIONS:

No limitations.

MAINTENANCE:

- ▶ Portable toilets should be maintained in good working order by licensed service with daily observation for leak detection.
- ▶ Regular waste collection should be arranged with licensed service.
- ▶ All waste should be deposited in sanitary sewer system for treatment with appropriate agency approval.

OBJECTIVES

- Housekeeping Practices
- Contain Waste
- Minimize Disturbed Areas
- Stabilize Disturbed Areas
- Protect Slopes/Channels
- Control Site Perimeter
- Control Internal Erosion



WEBER COUNTY

ENGINEERING DEPARTMENT

2380 Washington Blvd., Suite 240
Ogden, UT 84401
(801) 399-8374

TARGETED POLLUTANTS

- Sediment
- Nutrients
- Toxic Materials
- Oil & Grease
- Floatable Materials
- Other Construction Waste

- High Impact
- Medium Impact
- Low or Unknown Impact

IMPLEMENTATION REQUIREMENTS

- Capital Costs
- O&M Costs
- Maintenance
- Training

- High
- Medium
- Low

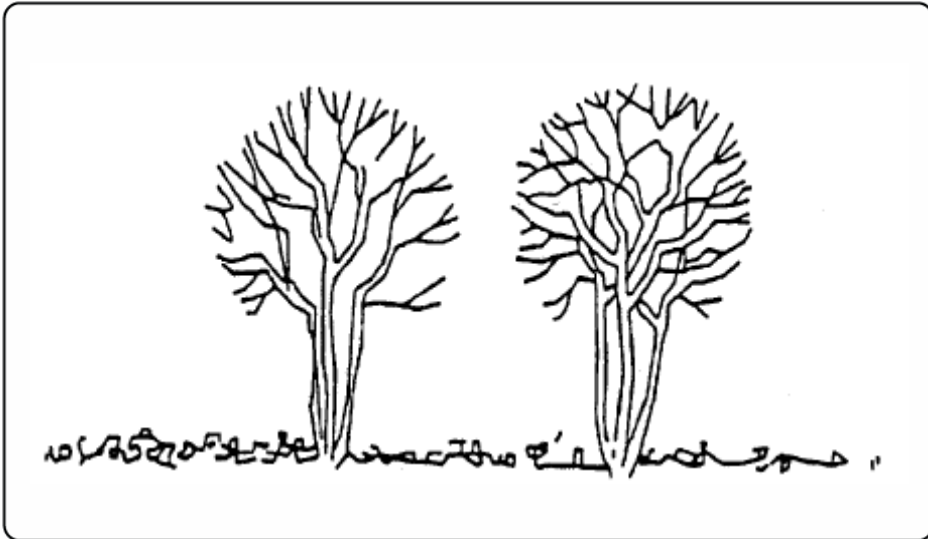

DESCRIPTION:

Carefully planned preservation of existing vegetation minimizes the potential of removing or injuring existing trees, vines, shrubs and/or grasses that serve as erosion controls.

APPLICATIONS:

- ▶ This technique is applicable to all types of sites. Areas where preserving vegetation can be particularly beneficial are floodplains, wetlands, stream banks, steep slopes, and other areas where erosion controls would be difficult to establish, install, or maintain.

INSTALLATION/APPLICATION CRITERIA:

- ▶ Clearly mark, flag or fence vegetation or areas where vegetation should be preserved.
- ▶ Prepare landscaping plans which include as much existing vegetation as possible and state proper care during and after construction.
- ▶ Define and protect with berms, fencing, signs, etc. a setback area from vegetation to be preserved.
- ▶ Propose landscaping plans which do not include plant species that compete with the existing vegetation.
- ▶ Do not locate construction traffic routes, spoil piles, etc. where significant adverse impact on existing vegetation may occur.

LIMITATIONS:

- ▶ Requires forward planning by the owner/developer, contractor and design staff.
- ▶ For sites with diverse topography, it is often difficult and expensive to save existing trees while grading the site satisfactorily for the planned development.
- ▶ May not be cost effective with high land costs.

MAINTENANCE:

- ▶ Inspection and maintenance requirements for protection of vegetation are low.
- ▶ Maintenance of native trees or vegetation should conform to landscape plan specifications.

OBJECTIVES

- Housekeeping Practices
- Contain Waste
- Minimize Disturbed Areas
- Stabilize Disturbed Areas
- Protect Slopes/Channels
- Control Site Perimeter
- Control Internal Erosion



WEBER COUNTY

ENGINEERING DEPARTMENT

2380 Washington Blvd., Suite 240
Ogden, UT 84401
(801) 399-8374

TARGETED POLLUTANTS

- Sediment
- Nutrients
- Toxic Materials
- Oil & Grease
- Floatable Materials
- Other Waste

- High Impact
- Medium Impact
- Low or Unknown Impact

IMPLEMENTATION REQUIREMENTS

- Capital Costs
- O&M Costs
- Maintenance
- Training

- High
- Medium
- Low

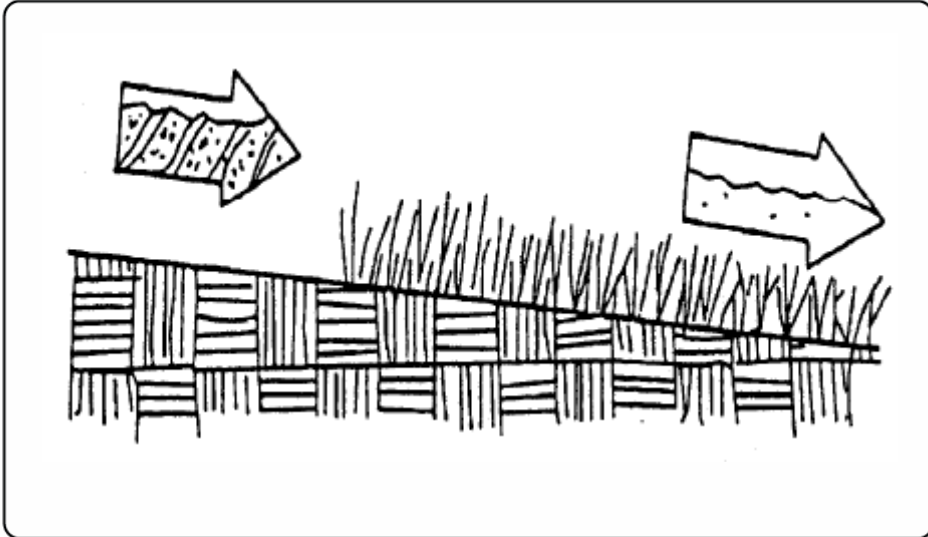

DESCRIPTION:

- ▶ Seeding of grass and plantings of trees, shrubs, vines and ground covers provide long-term stabilization of soil. In some areas, with suitable climates, grasses can be planted for temporary stabilization.

APPLICATION:

- ▶ Appropriate for site stabilization both during and after construction
- ▶ Any graded/cleared areas where construction activities have ceased.
- ▶ Open space cut and fill areas.
- ▶ Steep slopes, spoil piles, vegetated swales, landscape corridors, stream banks.

INSTALLATION/APPLICATION CRITERIA:

Type of vegetation, site and seedbed preparation, planting time, fertilization and water requirements should be considered for each application. Grasses:

- ▶ Ground preparation: fertilize and mechanically stabilize the soil.
- ▶ Tolerant of short-term temperature extremes and waterlogged soil composition.
- ▶ Appropriate soil conditions: shallow soil base, good drainage, slope 2:1 or flatter.
- ▶ Mowing, irrigating, and fertilizing are vital for promoting vigorous grass growth.

Trees and Shrubs:

- ▶ Selection criteria: vigor, species, size, shape & wildlife food source.
- ▶ Soil conditions: select species appropriate for soil, drainage & acidity.
- ▶ Other factors: wind/exposure, temperature extremes, and irrigation needs.

Vines and Ground Covers:

- ▶ Ground preparation: lime and fertilizer preparation.
- ▶ Use proper seeding rates.
- ▶ Appropriate soil conditions: drainage, acidity and slopes.
- ▶ Generally avoid species requiring irrigation.

LIMITATIONS:

- ▶ Permanent and temporary vegetation may not be appropriate in dry periods without irrigation.
- ▶ Fertilizer requirements may have potential to create stormwater pollution.

MAINTENANCE:

- ▶ Shrubs and trees must be adequately watered and fertilized and if needed pruned.
- ▶ Grasses may need to be watered and mowed.

OBJECTIVES

- Housekeeping Practices
- Contain Waste
- Minimize Disturbed Areas
- Stabilize Disturbed Areas
- Protect Slopes/Channels
- Control Site Perimeter
- Control Internal Erosion



WEBER COUNTY

ENGINEERING DEPARTMENT

2380 Washington Blvd., Suite 240
Ogden, UT 84401
(801) 399-8374

TARGETED POLLUTANTS

- Sediment
- Nutrients
- Toxic Materials
- Oil & Grease
- Floatable Materials
- Other Waste

- High Impact
- Medium Impact
- Low or Unknown Impact

IMPLEMENTATION REQUIREMENTS

- Capital Costs
- O&M Costs
- Maintenance
- Training

- High
- Medium
- Low

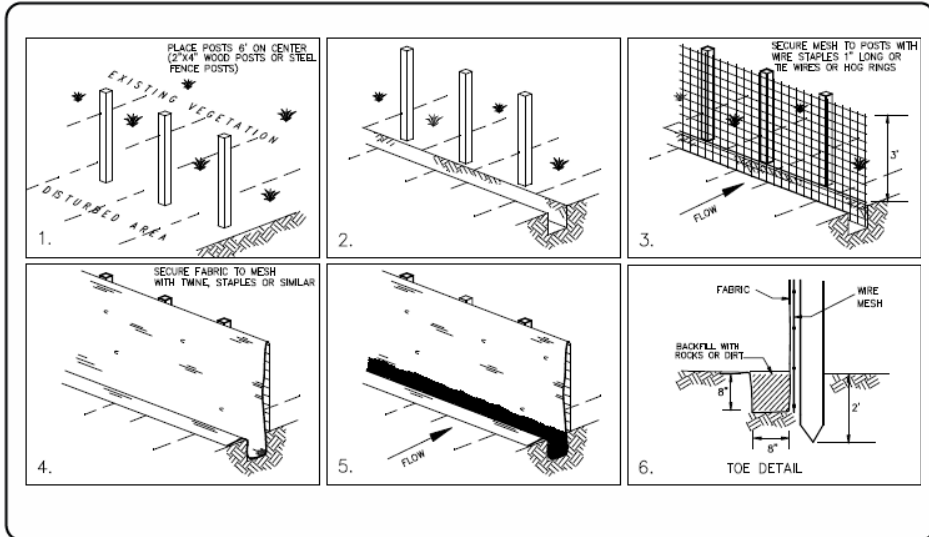

OBJECTIVES

- Housekeeping Practices
- Contain Waste
- Minimize Disturbed Areas
- Stabilize Disturbed Areas
- Protect Slopes/Channels
- Control Site Perimeter
- Control Internal Erosion

DESCRIPTION:

- ▶ A temporary sediment barrier consisting of entrenched filter fabric stretched across and secured to supporting posts.

APPLICATION:

- ▶ Perimeter control: place barrier at downgradient limits of disturbance
- ▶ Sediment barrier: place barrier at toe of slope or soil stockpile
- ▶ Protection of existing waterways: place barrier at top of stream bank
- ▶ Inlet protection: place fence surrounding catchbasins

INSTALLATION/APPLICATION CRITERIA:

- ▶ Place posts 6 feet apart on center along contour (or use preassembled unit) and drive 2 feet minimum into ground. Excavate an anchor trench immediately upgradient of posts.
- ▶ Secure wire mesh (14 gage min. With 6 inch openings) to upslope side of posts. Attach with heavy duty 1 inch long wire staples, tie wires or hog rings.
- ▶ Cut fabric to required width, unroll along length of barrier and drape over barrier. Secure fabric to mesh with twine, staples, or similar, with trailing edge extending into anchor trench.
- ▶ Backfill trench over filter fabric to anchor.

LIMITATIONS:

- ▶ Recommended maximum drainage area of 0.5 acre per 100 feet of fence
- ▶ Recommended maximum upgradient slope length of 150 feet
- ▶ Recommended maximum uphill grade of 2:1 (50%)
- ▶ Recommended maximum flow rate of 0.5 cfs
- ▶ Ponding should not be allowed behind fence

MAINTENANCE:

- ▶ Inspect immediately after any rainfall and at least daily during prolonged rainfall.
- ▶ Look for runoff bypassing ends of barriers or undercutting barriers.
- ▶ Repair or replace damaged areas of the barrier and remove accumulated sediment.
- ▶ Reanchor fence as necessary to prevent shortcutting.
- ▶ Remove accumulated sediment when it reaches ½ the height of the fence.



WEBER COUNTY

ENGINEERING DEPARTMENT

2380 Washington Blvd., Suite 240
Ogden, UT 84401
(801) 399-8374

TARGETED POLLUTANTS

- Sediment
- Nutrients
- Toxic Materials
- Oil & Grease
- Floatable Materials
- Other Waste

- High Impact
- Medium Impact
- Low or Unknown Impact

IMPLEMENTATION REQUIREMENTS

- Capital Costs
- O&M Costs
- Maintenance
- Training

- High
- Medium
- Low

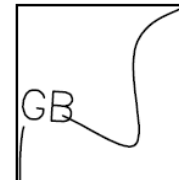
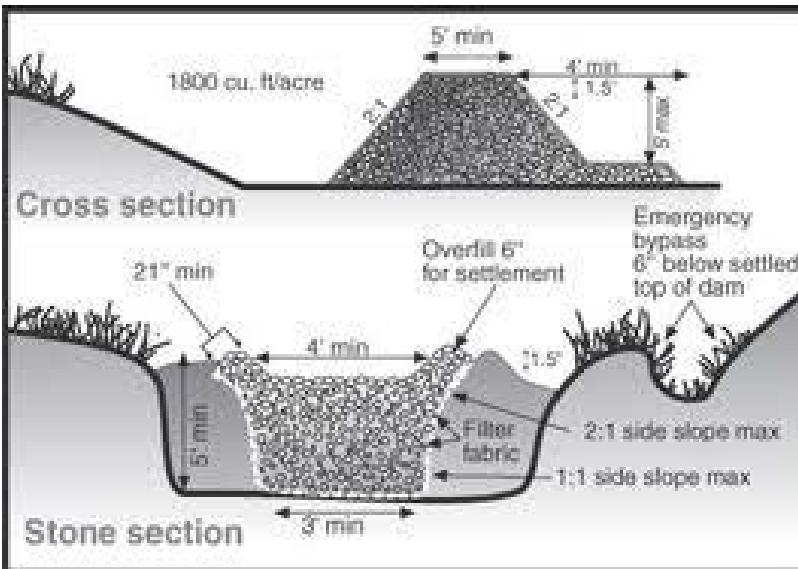

Definition and Purpose

A gravel bag barrier is a series of gravel-filled bags placed on a level contour to intercept sheet flows. Gravel bags pond sheet flow runoff, allowing sediment to settle out, and release runoff slowly as sheet flows, preventing erosion.

Appropriate Applications

- As a linear sediment control measure:
 - Below the toe of slopes and erodible slopes.
 - As sediment traps at culvert/pipe outlets.
 - Below other small cleared areas.
 - Along the perimeter of a site.
 - Down slope of exposed soil areas.
 - Around temporary stockpiles and spoil areas.
 - Parallel to a roadway to keep sediment off paved areas.
 - Along streams and channels.
- As linear erosion control measures:
 - Along the face and at grade breaks of exposed and erodible slopes to shorten slope length and spread runoff as sheet flow.
 - At the top of slopes to divert runoff away from disturbed slopes.

- As check dams across mildly sloped construction roads.

Limitations

- Gravel berms may be difficult to remove.
- Removal problems limit their usefulness in landscaped areas.
- Gravel bag berm may not be appropriate for drainage areas greater than 5 acres.
- Runoff will pond upstream of the filter, possibly causing flooding if sufficient spaces does not exist.
- Degraded gravel bags may rupture when removed, spilling contents.
- Installation can be labor intensive.
- Berms may have limited durability for long-term projects.
- When used to detain concentrated flows, maintenance requirements increase.

Standards and Specifications

- Locate gravel bag berms on level contours.
 - Slopes between 20:1 and 2:1 (H:V): gravel bags should be placed at a maximum interval of 50 ft. (a closer spacing is more effective), with the first row near the slope toe.
 - Slopes 2:1 (H:V) or steeper: gravel bags should be placed at a maximum interval of 25 ft. (a closer spacing is more effective), with the first row placed the slope toe.
- Turn the ends of the gravel bag barriers up slope to prevent runoff from going around the berm.
- Allow sufficient space up slope from the gravel bag berm to allow ponding, and to provide room for sediment storage.
- For installation near the toe of the slope, consider moving the gravel bag barriers away from the slope toe to facilitate cleaning. To prevent flows behind the barrier, bags can be placed perpendicular to the berm to serve as cross barriers.
- Drainage area should not exceed 5 acres.

Maintenance and Inspection

- Inspect BMPs prior to forecast rain, daily during extended rain events, after rain events, weekly during the rainy season, and at two-week

Gravel Barrier | GB

intervals during the non-rainy season.

- Gravel bags exposed to sunlight will need to be replaced every two to three months due to degrading of the bags.
- Reshape or replace gravel bags as needed.
- Repair washouts or other damage as needed.
- Sediment that accumulates in the BMP must be periodically removed in order to maintain BMP effectiveness. Sediment should be removed when the sediment accumulation reaches one-third of the barrier height. Sediment removed during maintenance may be incorporated into earthwork on the site or disposed of at an appropriate location.
- Remove gravel bag berms when no longer needed. Remove sediment accumulation and clean, re-grade, and stabilize the area. Removed sediment should be incorporated in the project or disposed of.

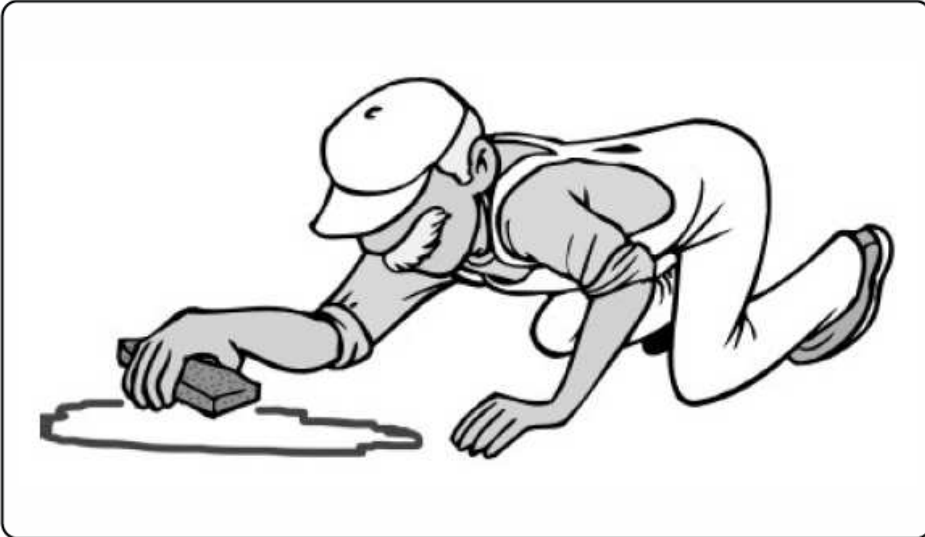

DESCRIPTION:

Practices to clean-up leakage/spillage of on-site materials that may be harmful to receiving waters.

APPLICATION:

- ▶ All sites

GENERAL:

- ▶ Store controlled materials within a storage area.
- ▶ Educate personnel on prevention and clean-up techniques.
- ▶ Designate an Emergency Coordinator responsible for employing preventative practices and for providing spill response.
- ▶ Maintain a supply of clean-up equipment on-site and post a list of local response agencies with phone numbers.

METHODS:

- ▶ Clean-up spills/leaks immediately and remediate cause.
- ▶ Use as little water as possible. NEVER HOSE DOWN OR BURY SPILL CONTAMINATED MATERIAL.
- ▶ Use rags or absorbent material for clean-up. Excavate contaminated soils. Dispose of clean-up material and soil as hazardous waste.
- ▶ Document all spills with date, location, substance, volume, actions taken and other pertinent data.
- ▶ Contact local Fire Department and State Division of Environmental Response and Remediation (Phone #536-4100) for any spill of reportable quantity.

OBJECTIVES

- Housekeeping Practices
- Contain Waste
- Minimize Disturbed Areas
- Stabilize Disturbed Areas
- Protect Slopes/Channels
- Control Site Perimeter
- Control Internal Erosion



WEBER COUNTY

ENGINEERING DEPARTMENT

2380 Washington Blvd., Suite 240
Ogden, UT 84401
(801) 399-8374

TARGETED POLLUTANTS

- Sediment
- Nutrients
- Toxic Materials
- Oil & Grease
- Floatable Materials
- Other Construction Waste

- High Impact
- Medium Impact
- Low or Unknown Impact

IMPLEMENTATION REQUIREMENTS

- Capital Costs
- O&M Costs
- Maintenance
- Training

- High
- Medium
- Low

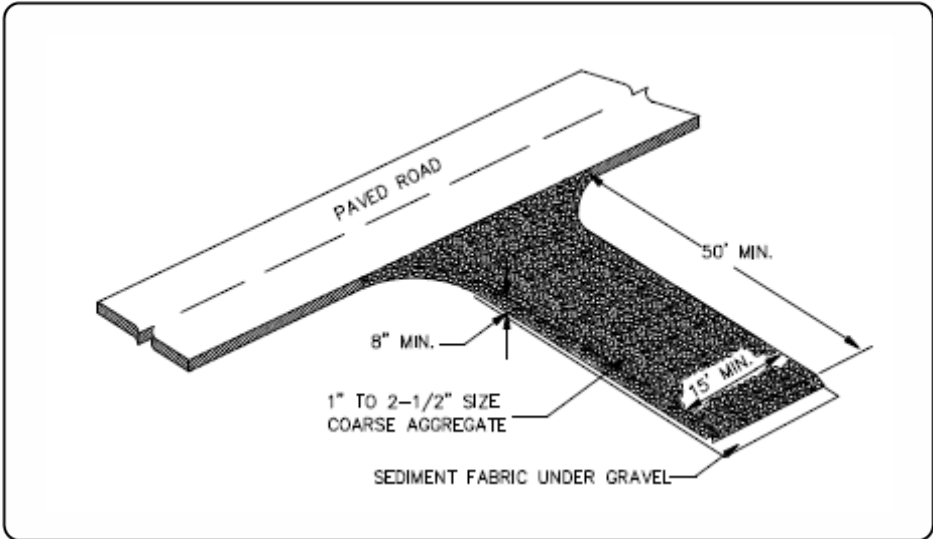

OBJECTIVES

- Housekeeping Practices
- Contain Waste
- Minimize Disturbed Areas
- Stabilize Disturbed Areas
- Protect Slopes/Channels
- Control Site Perimeter
- Control Internal Erosion



WEBER COUNTY

ENGINEERING DEPARTMENT

2380 Washington Blvd., Suite 240
 Ogden, UT 84401
 (801) 399-8374

DESCRIPTION:

A stabilized pad of crushed stone located where construction traffic enters or leaves the site from or to paved surface.

APPLICATIONS:

- ▶ At any point of ingress or egress at a construction site where adjacent traveled way is paved. Generally applies to sites over 2 acres unless special conditions exist.

INSTALLATION/APPLICATION CRITERIA:

- ▶ Clear and grub area and grade to provide maximum slope of 2%.
- ▶ Compact subgrade and place filter fabric if desired (recommended for entrances to remain for more than 3 months).
- ▶ Place coarse aggregate, 1 to 2-1/2 inches in size, to a minimum depth of 8 inches.

LIMITATIONS:

- ▶ Requires periodic top dressing with additional stones.
- ▶ Should be used in conjunction with street sweeping on adjacent public right-of-way.

MAINTENANCE:

- ▶ Inspect daily for loss of gravel or sediment buildup.
- ▶ Inspect adjacent roadway for sediment deposit and clean by sweeping or shoveling.
- ▶ Repair entrance and replace gravel as required to maintain control in good working condition.
- ▶ Expand stabilized area as required to accommodate traffic and prevent erosion at driveways.

TARGETED POLLUTANTS

- Sediment
- Nutrients
- Toxic Materials
- Oil & Grease
- Floatable Materials
- Other Waste

- High Impact
- Medium Impact
- Low or Unknown Impact

IMPLEMENTATION REQUIREMENTS

- Capital Costs
- O&M Costs
- Maintenance
- Training

- High
- Medium
- Low

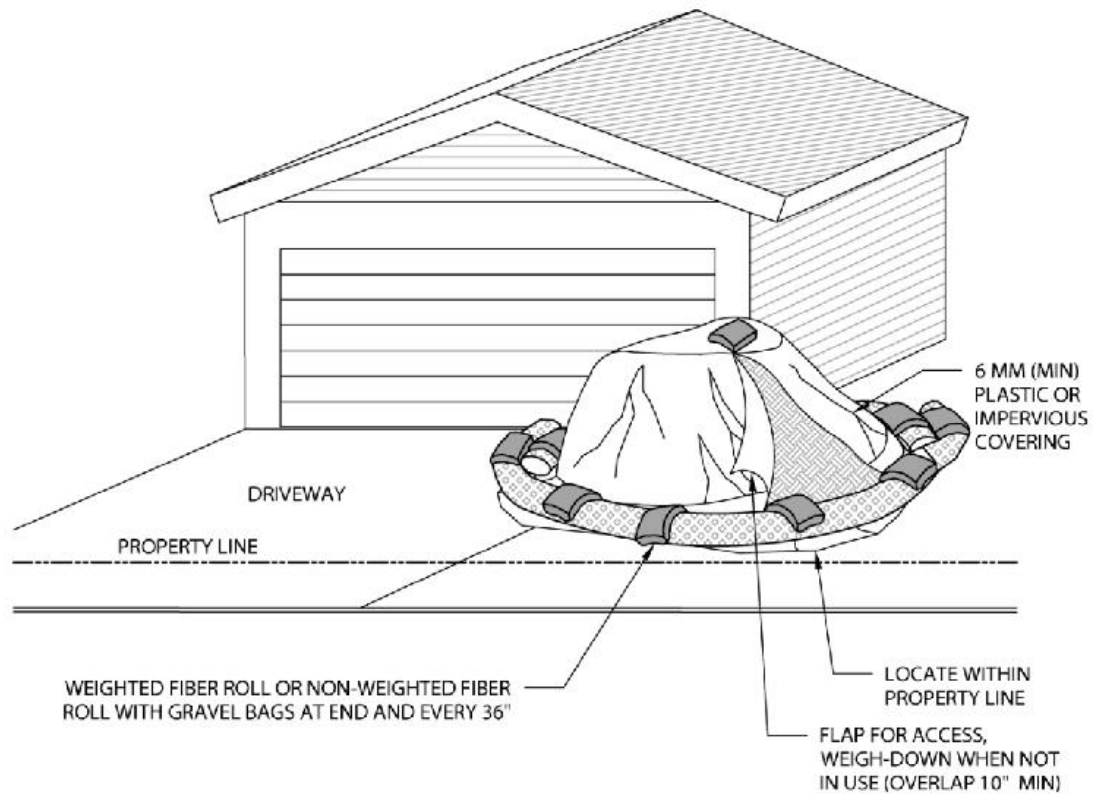

NOTES:

1. LOCATE STOCK AND/OR SPOIL PILES AWAY FROM DRAINAGE COURSES, DRAIN INLETS OR CONCENTRATED FLOWS OF STORMWATER.
2. ALL STOCK AND/OR SPOIL PILE PERIMETERS SHALL BE PROTECTED WITH TEMPORARY LINEAR SEDIMENT BARRIERS.
3. COVER ALL STOCK AND/OR SPOIL PILES WITH 6 MM PLASTIC, CANVAS TARP OR IMPERVIOUS COVER TO PREVENT WIND AND RAIN EROSION. EVENLY SPACE WEIGHTS (GRAVEL BAGS) ON COVER TO KEEP IN PLACE DURING WIND.
4. CONDUCT REGULAR INSPECTIONS OF STOCK AND/OR SPOIL PILES DURING AND AFTER RAIN EVENTS
5. VERY LARGE STOCK AND/OR SPOIL PILES MAY REQUIRE SILT FENCE IN LIEU OF FIBER ROLLS.
6. REMOVE SPOIL PILES FROM CONSTRUCTION SITE AS SOON AS POSSIBLE.
7. STOCK/SPOIL PILES MUST BE STORED WITHIN THE APPROVED STAGING AREA.

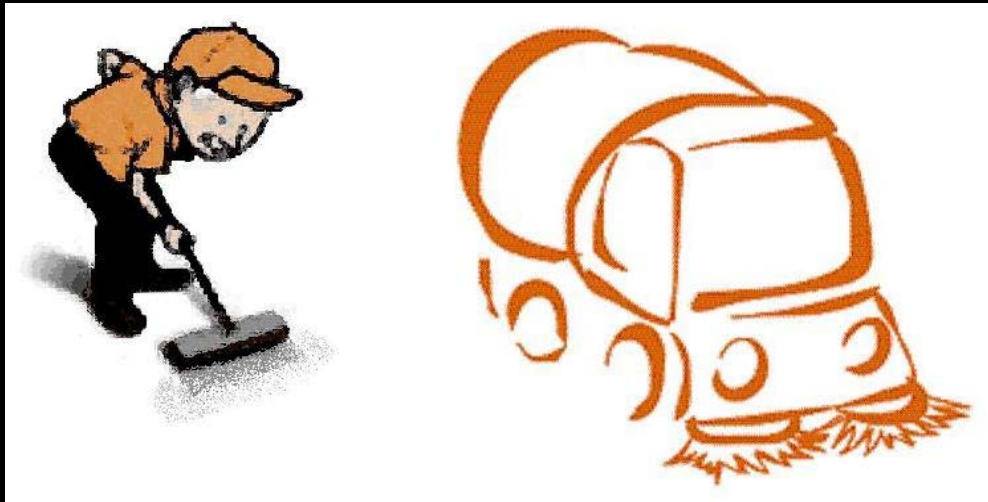

OBJECTIVES

- Housekeeping Practices
- Contain Waste
- Minimize Disturbed Areas
- Stabilize Disturbed Areas
- Protect Slopes/Channels
- Control Site Perimeter
- Control Internal Erosion

TARGETED POLLUTANTS

H M L

- Sediment
- Nutrients
- Heavy Metals
- Toxic Materials
- Oil & Grease
- Floatable Materials
- Bacteria & Viruses
- Other Waste

IMPLEMENTATION REQUIREMENTS

H M L

- Capital Costs
- O&M Costs
- Maintenance
- Training
- Staffing
- Administrative

H = High M = Medium L = Low

DESCRIPTION:

Prevent sediment from entering storm water by sweeping the streets near construction activities.

APPLICATION:

- Useful for any paved streets near construction sites where sediment is blown, tracked, or spilled onto the streets.

INSTALLATION / APPLICATION CRITERIA:

- The equipment used should be appropriate for the conditions. Vacuum sweepers work more effectively when the area is dry. Brush sweepers work better when the sediment is wet or stuck to the surface.
- Mechanical equipment should be operated and maintained according to the manufacturer's recommendations

LIMITATIONS:

- Is labor and equipment intensive
- May cause dust

MAINTENANCE:

- The street should be checked daily for any sediment deposits. Street sweeping should be implemented whenever sediment from construction activity is found on the streets

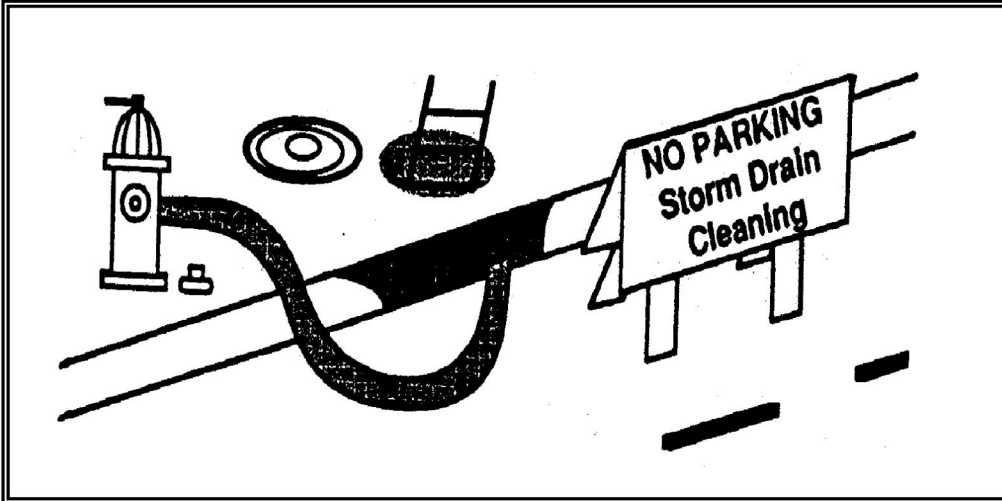

DESCRIPTION:

A storm drain is "flushed" with water to suspend and remove deposited materials. Flushing is particularly beneficial for storm drain pipes with grades too flat to be self-cleansing. Flushing helps ensure pipes convey design flow and remove pollutants from the storm drain system.

APPROACH:

- ▶ Locate reaches of storm drain with deposit problems and develop a flushing schedule that keeps the pipe clear of excessive buildup.
- ▶ Whenever possible, flushed effluent should be collected, decanted, evaporated, and disposed of in a landfill.

LIMITATIONS:

- ▶ Most effective in small diameter pipes (36-inch diameter pipe or less, depending on water supply and sediment collection capacity).
- ▶ Water source must be available.
- ▶ May have difficulty finding downstream area to collect sediments.
- ▶ Requires liquid/sediment disposal.

PROGRAM ELEMENTS

- New Development
- Residential
- Commercial Activities
- Industrial Activities
- Municipal Facilities
- Illegal Discharges

TARGETED POLLUTANTS

- Sediment
- Nutrients
- Heavy Metals
- Toxic Materials
- Oxygen Demanding Substances
- Oil & Grease
- Floatable Materials
- Bacteria & Viruses

- High Impact
- Medium Impact
- Low or Unknown Impact

IMPLEMENTATION REQUIREMENTS

- Capital Costs
- O&M Costs
- Regulatory
- Training
- Staffing
- Administrative

- High Medium Low

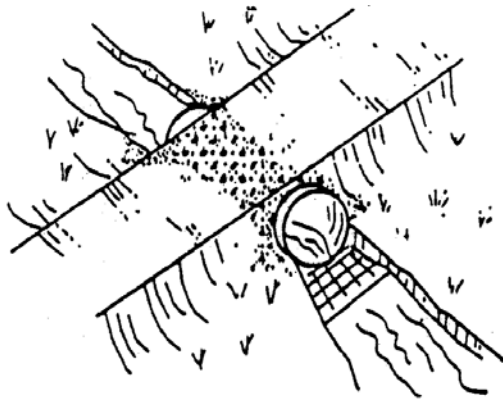

DESCRIPTION:

A temporary access stream crossing is a temporary culvert, ford or bridge placed across a waterway to provide access for construction purposes for a period of less than one year. Temporary access crossings are not intended to be used to maintain traffic for the general public.

APPLICATIONS:

Temporary stream crossings should be installed at all designated crossings of perennial and intermittent streams on the construction site, as well as for dry channels which may be significantly eroded by construction traffic.

INSTALLATION/APPLICATION:

Requires knowledge of stream flows and soil strength and should be designed under the direction of a Utah registered engineer with knowledge of both hydraulics and construction loading requirements for structures.

LIMITATIONS:

- ▶ May be expensive for a temporary improvement.
- ▶ Requires other BMP's to minimize soil disturbance during installation and removal.
- ▶ Fords should only be used in dry weather.
- ▶ A Stream Alteration Permit may be required, contact the Utah Division of Water Rights before implementation.

MAINTENANCE:

- ▶ Inspect weekly and after each significant rainfall, including assessment of foundations.
- ▶ Periodically remove silt from crossings.
- ▶ Replace lost aggregated from inlets and outlets of culverts.

OBJECTIVES

- Housekeeping Practices
- Contain Waste
- Minimize Disturbed Areas
- Stabilize Disturbed Areas
- Protect Slopes/Channels
- Control Site Perimeter
- Control Internal Erosion

TARGETED POLLUTANTS

- Sediment
- Nutrients
- Toxic Materials
- Oil & Grease
- Floatable Materials
- Other Waste

- High Impact
- Medium Impact
- Low or Unknown Impact

IMPLEMENTATION REQUIREMENTS

- Capital Costs
- O&M Costs
- Maintenance
- Training

- High
- Medium
- Low



Used oil can be disposed of at a waste collection facility, where it will be collected and later sent to a recycling facility

APPLICATIONS

- Manufacturing
- Material Handling
- Vehicle Maintenance
- Construction
- Commercial Activities
- Roadways
- Waste Containment
- Housekeeping Practices

DESCRIPTION:

Used motor oil is a hazardous waste because it contains heavy metals picked up from the engine during use. Since it is toxic to humans, wildlife, and plants, it should be disposed of at a local recycling or disposal facility or by contracting with an outside firm specializing in recycling or disposing of this material.

APPROACH:

- When establishing oil recycling programs, municipalities should provide the public with the proper informational resources.
- The public can also call 1-800-RECYCLE or contact Earth's 911 at www.1800cleanup.org/ for more information.
- Municipalities also need to address oil filter recycling in their recycling programs.
- To make recycling motor oil more convenient for the do-it-yourselfers, oil recycling programs should be located throughout all communities.
- Two types of programs currently in use are drop-off locations and curbside collection. Drop-off locations include service stations, recycling centers, auto parts retail stores, quick lubes, and landfills.

LIMITATIONS:

- If oil is mixed with other substances or if storage containers have residues of other substances, this can contaminate oil and make it a hazardous waste.
- It is often difficult to effectively educate the public and convince them of the importance of recycling oil. This limitation can be addressed if municipalities include recycling information in utility bill inserts, newspaper ads, and mailings.

MAINTENANCE:

- Costs for used motor oil recycling programs vary depending on whether a community has already established similar types of recycling programs.
- Major costs associated with oil recycling programs include advertisement costs and oil collection costs.

TARGETED POLLUTANTS

- Sediment
- Nutrients
- Heavy Metals
- Toxic Materials
- Oxygen Demanding Substances
- Oil & Grease
- Floatable Materials
- Bacteria & Viruses

<ul style="list-style-type: none"> <input checked="" type="checkbox"/> High Impact <input checked="" type="checkbox"/> Medium Impact <input type="checkbox"/> Low or Unknown Impact
--

IMPLEMENTATION REQUIREMENTS

- Capital Costs
 - O&M Costs
 - Maintenance
 - Training
- | | | |
|--|--|------------------------------|
| <input checked="" type="checkbox"/> High | <input checked="" type="checkbox"/> Medium | <input type="checkbox"/> Low |
|--|--|------------------------------|

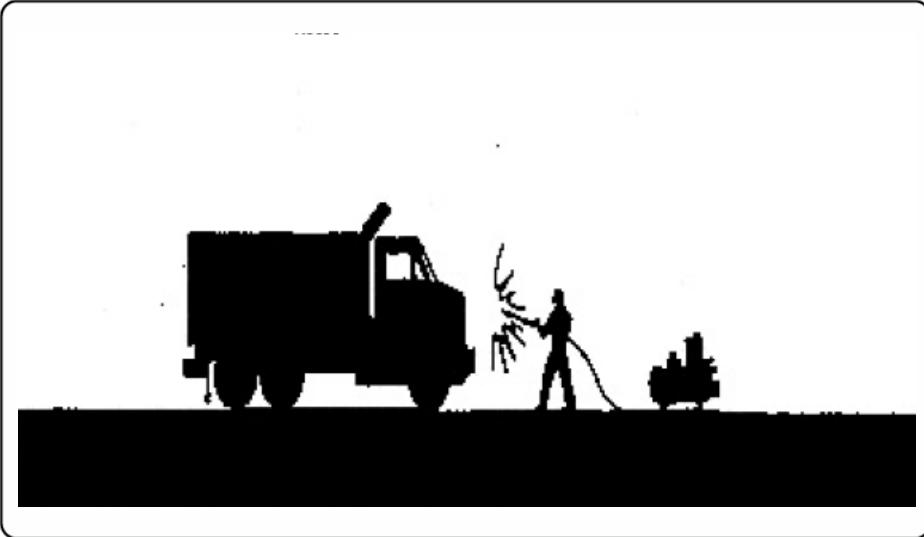

DESCRIPTION:

Prevent or reduce the discharge of pollutants to stormwater from vehicle and equipment washing and steam cleaning by using off-site facilities, washing in designated, contained areas only, eliminating discharges to the storm drain by infiltrating or recycling the wash water, and training employees and subcontractors.

APPROACH:

- ▶ Use off-site commercial washing and steam cleaning businesses as much as possible. Washing vehicles and equipment outdoors or in areas where wash water flows onto paved surfaces or into drainage pathways can pollute stormwater. If you wash a large number of vehicles or pieces of equipment, consider conducting this work at an off-site commercial business. These businesses are better equipped to handle and dispose of the wash waters properly. Performing this work off-site can also be economical by eliminating the need for a separate washing operation at your site.
- ▶ If washing must occur on-site, use designated, bermed wash areas to prevent wash water contact with stormwater, creeks, rivers, and other water bodies. The wash area can be sloped for wash water collection and subsequent infiltration into the ground.
- ▶ Use as little water as possible to avoid having to install erosion and sediment controls for the wash area. Use phosphate-free biodegradable soaps. Educate employees and subcontractors on pollution prevention measures. Do not permit steam cleaning on-site. Steam cleaning can generate significant pollutant concentrations.

LIMITATIONS:

- ▶ Even phosphate-free, biodegradable soaps have been shown to be toxic to fish before the soap degrades.
- ▶ Sending vehicles/equipment off-site should be done in conjunction with Stabilized Construction Entrance. (See BMP in the Construction Section).
- ▶ The measures outlined in this fact sheet are insufficient to address all the environmental impacts and compliance issues related to steam cleaning.

MAINTENANCE:

- ▶ Minimal, some berm repair may be necessary.

OBJECTIVES

- Manufacturing
- Material Handling
- Vehicle Maintenance
- Construction
- Commercial Activities
- Roadways
- Waste Containment
- Housekeeping Practices



WEBER COUNTY

ENGINEERING DEPARTMENT

2380 Washington Blvd., Suite 240
Ogden, UT 84401
(801) 399-8374

TARGETED POLLUTANTS

- Sediment
- Nutrients
- Heavy Metals
- Toxic Materials
- Oxygen Demanding Substance
- Oil & Grease
- Floatable Materials
- Bacteria & Viruses
- High Impact
- Medium Impact
- Low or Unknown Impact

IMPLEMENTATION REQUIREMENTS

- Capital Costs
- O&M Costs
- Maintenance
- Training
- High
- Medium
- Low

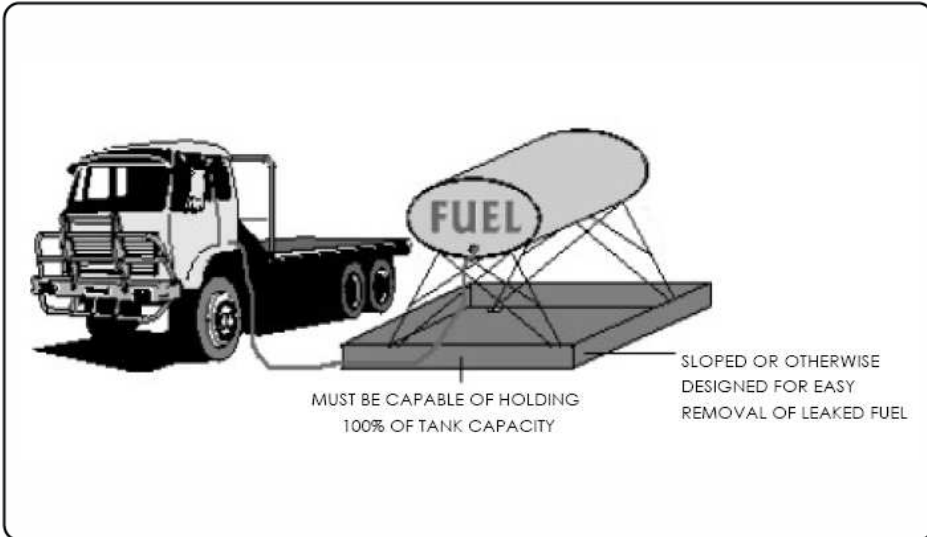

OBJECTIVES

- Manufacturing
- Material Handling
- Vehicle Maintenance
- Construction
- Commercial Activities
- Roadways
- Waste Containment
- Housekeeping Practices



WEBER COUNTY

ENGINEERING DEPARTMENT

2380 Washington Blvd., Suite 240
Ogden, UT 84401
(801) 399-8374

DESCRIPTION:

Prevent fuel spills and leaks, and reduce their impacts to stormwater by using off-site facilities, fueling in designated areas only, enclosing or covering stored fuel, implementing spill controls, and training employees and subcontractors.

APPROACH:

- ▶ Use off-site fueling stations as much as possible. Fueling vehicles and equipment outdoors or in areas where fuel may spill/leak onto paved surfaces or into drainage pathways can pollute stormwater. If you fuel a large number of vehicles or pieces of equipment, consider using an off-site fueling station. These businesses are better equipped to handle fuel and spills properly. Performing this work off-site can also be economical by eliminating the need for a separate fueling area at your site.
- ▶ If fueling must occur on-site, use designated areas, located away from drainage courses, to prevent the runoff of stormwater and the runoff of spills.
- ▶ Discourage "topping-off" of fuel tanks.
- ▶ Always use secondary containment, such as a drain pan or drop cloth, when fueling to catch spills/leaks. Place a stockpile of spill cleanup materials where it will be readily accessible. Use adsorbent materials on small spills rather than hosing down or burying the spill. Remove the adsorbent materials promptly and dispose of properly.
- ▶ Carry out all federal and state requirements regarding stationary above ground storage tanks. Avoid mobile fueling of mobile construction equipment around the site; rather, transport the equipment to designated fueling areas. With the exception of tracked equipment such as bulldozers and perhaps forklifts, most vehicles should be able to travel to a designated area with little lost time. Train employees and subcontractors in proper fueling and cleanup procedures.

LIMITATIONS:

- ▶ Sending vehicles/equipment off-site should be done in conjunction with Stabilized Construction Entrance (See BMP sheet in Construction section).

MAINTENANCE:

- ▶ Keep ample supplies of spill cleanup materials on-site.
- ▶ Inspect fueling areas and storage tanks on a regular schedule.

TARGETED POLLUTANTS

- Sediment
- Nutrients
- Heavy Metals
- Toxic Materials
- Oxygen Demanding Substance
- Oil & Grease
- Floatable Materials
- Bacteria & Viruses
- High Impact
- Medium Impact
- Low or Unknown Impact

IMPLEMENTATION REQUIREMENTS

- Capital Costs
- O&M Costs
- Maintenance
- Training
- High
- Medium
- Low

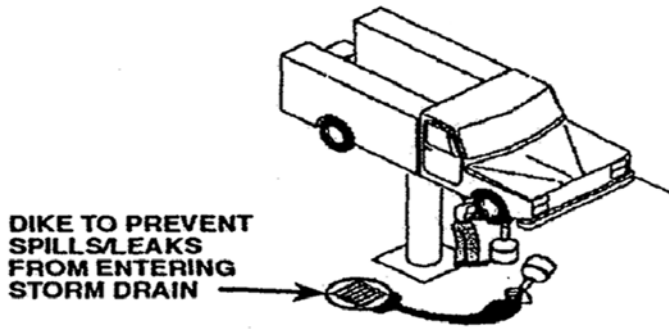

(INSIDE MAINTENANCE FACILITY)

APPLICATIONS

- Manufacturing
- Material Handling
- Vehicle Maintenance
- Construction
- Commercial Activities
- Roadways
- Waste Containment
- Housekeeping Practices

DESCRIPTION:

Prevent or reduce the discharge of pollutants to stormwater from vehicles and equipment maintenance and repair by running a dry shop.

APPROACH:

- ▶ Keep equipment clean, don't allow excessive build-up of oil and grease.
- ▶ Keep drip pans or containers under the areas that might drip.
- ▶ Do not change motor oil or perform equipment maintenance in non-appropriate areas.
- ▶ Inspect equipment for leaks on a regular basis.
- ▶ Segregate wastes.
- ▶ Make sure oil filters are completely drained and crushed before recycling or disposal.
- ▶ Make sure incoming vehicles are checked for leaking oil and fluids.
- ▶ Clean yard storm drain inlets regularly and especially after large storms.
- ▶ Do not pour materials down drains or hose down work areas; use dry seeping.
- ▶ Store idle equipment under cover.
- ▶ Drain all fluids from wrecked vehicles.
- ▶ Recycle greases, used oil or oil filters, antifreeze, cleaning solutions, automotive batteries, hydraulic, and transmission fluids.
- ▶ Switch to non-toxic chemicals for maintenance when possible.
- ▶ Clean small spills with rags, general clean-up with damp mops and larger spills with absorbent material.
- ▶ Paint signs on storm drain inlets to indicate that they are not to receive liquid or solid wastes.
- ▶ Train employees, minimize use of solvents.

LIMITATIONS:

- ▶ Space and time limitations may preclude all work being conducted indoors.
- ▶ It may not be possible to contain and clean up spills from vehicles/equipment brought on-site after working hours.
- ▶ Dry pans are generally too small to contain antifreeze, which may gush from some vehicles, so drip pans may have to be purchased or fabricated.
- ▶ Dry floor cleaning methods may not be sufficient for some spills.

MAINTENANCE:

Should be low if procedures for the approach are followed.

TARGETED POLLUTANTS

- Sediment
- Nutrients
- Heavy Metals
- Toxic Materials
- Oxygen Demanding Substances
- Oil & Grease
- Floatable Materials
- Bacteria & Viruses

- High Impact
- Medium Impact
- Low or Unknown Impact

IMPLEMENTATION REQUIREMENTS

- Capital Costs
- O&M Costs
- Maintenance
- Training

- High
- Medium
- Low



APPLICATIONS

- Manufacturing
- Material Handling
- Vehicle Maintenance
- Construction
- Commercial Activities
- Roadways
- Waste Containment
- Housekeeping Practices

DESCRIPTION:

Prevent or reduce the discharge of pollutants to stormwater from waste handling and disposal; reducing waste generation and disposal through source reduction, re-use, and recycling; and preventing runoff and runoff from waste management areas.

APPROACH:

- ▶ Substitute or eliminate raw materials.
- ▶ Modify process or equipment.
- ▶ SARA Title III, Section 313 requires reporting for over 300 listed chemicals and chemical compounds. This requirement should be used to track these chemicals although this is not as accurate a means of tracking as other approaches.
- ▶ Use design data and review: process flow diagram, materials and applications diagram, piping and instructions, equipment list, plot plan.
- ▶ Use economic data and review: Waste treatment and disposal cost. Product utility and economic cost. Operation and maintenance labor cost.
- ▶ Recycle materials whenever possible.
- ▶ Segregation and separate waste.
- ▶ Cover, enclose, or berm industrial wastewater management areas whenever possible to prevent contact with runoff or runoff.
- ▶ Equip waste transport vehicles with anti-spill equipment.
- ▶ Minimize spills and fugitive losses such as dust or mist from loading systems.
- ▶ Ensure that sediments or wastes are prevented from being tracked off-site.
- ▶ Training and supervision.
- ▶ Stencil storm drains on the facility's property with prohibitive message regarding waste disposal.

LIMITATIONS:

Hazardous waste that cannot be re-used or recycled must be disposed of by a licensed hazardous waste hauler.

TARGETED POLLUTANTS

- Sediment
- Nutrients
- Heavy Metals
- Toxic Materials
- Oxygen Demanding Substances
- Oil & Grease
- Floatable Materials
- Bacteria & Viruses

- High Impact
- Medium Impact
- Low or Unknown Impact

IMPLEMENTATION REQUIREMENTS

- Capital Costs
- O&M Costs
- Maintenance
- Training

- High
- Medium
- Low

Appendix I: Construction General Permit

If all storm water team members access the CGP via the internet while on site the following link to access the Construction General Permit is sufficient:

<http://construction.stormwater.utah.gov>

Otherwise, include a printed out copy of the Construction General Permit in this appendix.

STATE OF UTAH
DEPARTMENT OF ENVIRONMENTAL QUALITY
DIVISION OF WATER QUALITY
Utah Pollutant Discharge Elimination System (UPDES)
General Permit for Storm Water Discharges from Construction Activities
UPDES Permit No. UTRC00000

This Permit is issued in compliance with the provisions of the Utah Water Quality Act, Title 19, Chapter 5, Utah Code Annotated 2004, as amended (the "Act") and the federal Water Pollution Control Act (33 U.S.c. §§ 1251 et. seq., as amended by the Water Quality Act of 1987, P.L. 100-4), and the rules and Regulations made pursuant to those statutes. This permit authorizes "owners/operators" of construction activities (defined in Part 1.1.1 and Part 10) that meet the requirements of Part 1. of this Utah Pollutant Discharge Elimination System (UPDES) general permit, to discharge pollutants in accordance with the effluent limitations and conditions set forth herein. Permit coverage is required from the "commencement of earth-disturbing activities" (see Part 10) until "final stabilization" (see Part 2.2.14).

This permit becomes effective on July 1, 2019.

This permit and the authorization to discharge expire at midnight on June 30, 2024.

Signed this 18th day of June, 2019



Erica Brown Gaddis, PhD
Director

Table of Contents

1. COVERAGE UNDER THIS PERMIT 1

1.1. ELIGIBILITY CONDITIONS 1

1.2. DISCHARGES AUTHORIZED UNDER THIS PERMIT. 3

1.3. PROHIBITED DISCHARGES..... 4

1.4. NOTICE OF INTENT (NOI)..... 4

1.5. REQUIREMENT TO POST A NOTICE OF YOUR PERMIT COVERAGE..... 6

2. TECHNOLOGY-BASED EFFLUENT LIMITATIONS..... 7

2.1. GENERAL STORM WATER CONTROL DESIGN, INSTALLATION, AND MAINTENANCE REQUIREMENTS. 7

2.2. EROSION AND SEDIMENT CONTROL REQUIREMENTS..... 8

2.3. POLLUTION PREVENTION REQUIREMENTS..... 13

3. WATER QUALITY-BASED EFFLUENT LIMITATIONS. 17

3.1. GENERAL EFFLUENT LIMITATION TO MEET APPLICABLE WATER QUALITY STANDARDS. 17

3.2. DISCHARGE LIMITATIONS FOR SITES DISCHARGING TO SENSITIVE WATERS..... 17

4. SITE INSPECTION REQUIREMENTS. 19

4.1. PERSON(S) RESPONSIBLE FOR INSPECTING THE SITE. 19

4.2. FREQUENCY OF INSPECTIONS..... 19

4.3. INCREASE IN INSPECTION FREQUENCY FOR SITES DISCHARGING TO SENSITIVE WATERS..... 19

4.4. REDUCTIONS IN INSPECTION FREQUENCY..... 20

4.5. AREAS THAT MUST BE INSPECTED..... 21

4.6. REQUIREMENTS FOR INSPECTIONS 22

4.7.	INSPECTION REPORT	22
4.8.	INSPECTIONS BY DWQ	23
5.	CORRECTIVE ACTIONS	24
5.1.	CONDITIONS TRIGGERING CORRECTIVE ACTION.....	24
5.2.	CORRECTIVE ACTION DEADLINES	24
5.3.	CORRECTIVE ACTION REQUIRED BY DWQ	24
5.4.	CORRECTIVE ACTION REPORT	24
6.	STAFF TRAINING REQUIREMENTS.....	26
7.	STORM WATER POLLUTION PREVENTION PLAN (SWPPP)	27
7.1.	GENERAL REQUIREMENTS.....	27
7.2.	SWPPP WRITER/REVIEWER CERTIFICATION REQUIREMENT	27
7.3.	SWPPP CONTENTS.	27
7.4.	ON-SITE AVAILABILITY OF YOUR SWPPP	33
7.5.	SWPPP MODIFICATIONS.	33
8.	HOW TO TERMINATE COVERAGE.....	34
8.1.	MINIMUM INFORMATION REQUIRED IN NOT.....	34
8.2.	CONDITIONS FOR TERMINATING CGP COVERAGE.....	34
8.3.	HOW TO SUBMIT YOUR NOT.....	35
8.4.	DEADLINE FOR SUBMITTING THE NOT.	35
8.5.	PARTIAL NOT REQUIREMENTS.....	35
8.6.	EFFECTIVE DATE OF TERMINATION OF COVERAGE.	35
9.	STANDARD PERMIT CONDITIONS.....	36
10.	DEFINITIONS AND ACRONYMS.....	40

Appendix A – BUFFER REQUIREMENTS

1. COVERAGE UNDER THIS PERMIT

To be covered under this permit you must meet the eligibility conditions and follow the requirements for applying for permit coverage in this Part.

1.1. ELIGIBILITY CONDITIONS

1.1.1. All “operators” of a construction site must sign on the notice of intent or NOI (see part 1.4 for NOI). Owners (or lessee’s) and general contractors are both considered “operators” for the purposes of this permit (see definition of “operator” in Part 10). Except for areas listed in part 1.2.2, this permit does not cover area that is not legally owned or leased by the operator defined in Part 10, that has operational control over construction plans and specifications.

1.1.2. The Project:

- a. A project covered by this permit will **disturb 1 or more acres** of land, or will disturb less than 1 acre of land but be part of a common plan of development or sale¹ that will ultimately disturb 1 or more acres of land; or
- b. A project’s **discharges have been designated** by the Director as needing a permit under UAC 317-8-3.9(1)(a)5. or UAC 317-8-3.9(6)(e)2.
- c. **Single lot residential projects** that disturb **less than 1 acre** of land and are part of a common plan of development or sale may be covered under the Common Plan Permit (UTRH00000) in lieu of this permit. Information on this permit can be found on the DWQ construction storm water web site at <https://deq.utah.gov/legacy/permits/water-quality/utah-pollutant-discharge-elimination-system/storm-water-general-construction.htm>.
- d. Projects **less than five acres** with a **rainfall erosivity factor** (“R” in the revised universal soil loss equation, or RUSLE) value of **less than five** during the period of construction activity may waive the requirements of this permit by submitting an **Erosivity Waiver Certification**. Information on the Erosivity Waiver can be found on the DWQ construction storm water web site at <https://deq.utah.gov/legacy/permits/water-quality/utah-pollutant-discharge-elimination-system/storm-water-general-construction.htm>.

1.1.3. A project is located within the state of Utah, except for Indian Country (Storm water permits for Indian Country within the State must be acquired through EPA Region VIII, except for facilities on the Navajo Reservation or on the Goshute Reservation which must acquire storm water permits through EPA Region IX).

1.1.4. Discharges from a project cannot;

- a. **already have coverage** under the UPDES CGP or any other UPDES permit for a storm water discharge associated with construction activity (UPDES wastewater and industrial permit coverage for separate discharges associated with the site is allowed) or,

¹ See definition for common plan of development or sale in Part 10

- b. **be in the process of receiving coverage** under a different UPDES permit for a storm water discharge from construction activities that has been denied, terminated, or revoked²,
- c. **be treated with “cationic treatment chemicals”** (see Definitions) unless and until you notify DWQ in advance of receiving permit coverage and have received written approval. To be able to use “cationic treatment chemicals” you must demonstrate to DWQ that appropriate controls and implementation procedures are used to ensure that your use of cationic treatment chemicals will not lead to discharges that cause an exceedance of water quality standards or harm fish populations.

1.1.5. Eligibility for Emergency-Related Construction Activities. If you are conducting earth-disturbing activities in response to a public emergency (e.g., natural disaster, widespread disruption in essential public services), and the related work requires immediate authorization to avoid imminent endangerment to human health, public safety, or the environment, or to reestablish public services, your requirements are:

- a. If the emergency related activity is accomplished within 30-days you are waived from the normal requirements to submit an NOI and prepare a SWPPP, but you must submit a report to DWQ within 45-days and show:
 - (1) the nature of the emergency work performed,
 - (2) a description of earth disturbances that occurred,
 - (3) the proximity of the work to waters of the State, and what was done to protect water quality during the emergency work, and
 - (4) the occurrence of the public emergency must be substantiated.
- b. If the emergency activity continues longer than 30-days you are authorized to discharge on the condition that a complete and accurate NOI is submitted within 30 calendar days after commencing earth-disturbing activities establishing that you are eligible under this permit. You are also required to provide emergency documentation in your SWPPP to substantiate the occurrence of the public emergency.

1.1.6. Water Quality Standards – Eligibility for New Sources. If you are a “new source” (as defined in Part 10), you are not eligible for coverage under this permit for discharges that have the reasonable potential to cause, or contribute to an excursion above any applicable water quality standard. Where such a determination is made, adjustments must be made to storm water controls to bring the discharge into compliance with water quality standards immediately or permit coverage will be rescinded. DWQ expects that compliance with the storm water control requirements of this permit, including the requirements applicable to such discharges in Part 3.2, will result in discharges that will not cause, have the reasonable potential to cause, or contribute to an excursion above any applicable water quality standard.

² Projects having been denied, terminated, or revoked must resolve the problem causing the ineligibility before the same or other coverage will be restored.

1.1.7. Discharging to Waters with High Water Quality – Eligibility for New Sources. If you are a “new source” (as defined in Part 10), you are eligible to discharge to a Category 1 water if your discharge is temporary and limited and where best management practices will be employed to minimize pollution effects, to a Category 2 water only if your discharge will not lower the water quality of the applicable water body. In the absence of information demonstrating otherwise, DWQ expects that compliance with the storm water control requirements of this permit, including the requirements applicable to such discharges in Part 3.2, will result in discharges that will not lower the water quality of the applicable water.

Your project will be considered to discharge to a Category 1 or 2 water if the first surface water to which you discharge is identified by the state as a Category 1 or 2 water. For discharges that enter a storm sewer system prior to discharge, the first surface water to which you discharge is the water body that receives the storm water discharge from the storm sewer system. Please refer to water quality information at <http://mapserv.utah.gov/surfacewaterquality/>

1.2. DISCHARGES AUTHORIZED UNDER THIS PERMIT. The following is a list of discharges that are allowed under this permit provided that appropriate storm water controls are designed, installed, and maintained:

1.2.1. Storm water discharges, including **storm water, snowmelt, and surface water runoff and drainage**, associated with construction activity under UAC R317-8-3.9(6)(d)10. or UAC R317-8-3.9(6)(e)1.;

1.2.2. Storm water discharges from **construction support activities** (e.g., concrete or asphalt batch plants, equipment staging yards, material storage areas, excavated material disposal areas, borrow areas) provided:

- a. The support **activity is directly related to the construction site** required to have permit coverage for storm water discharges;
- b. The support activity **does not serve multiple unrelated construction projects**;
- c. The support activity **does not continue to operate beyond the completion of the construction activity** at the project it supports; and
- d. Storm water controls are implemented in accordance with Part 2 and, if applicable, Part 3, for discharges from the support activity areas.

1.2.3. The following non-storm water discharges from your construction activity are allowed under this permit, provided that you comply with all applicable requirements for these discharges in Part 2:

- a. Discharges from emergency fire-fighting activities;
- b. Fire hydrant flushings;
- c. Properly managed landscape irrigation;
- d. Water used to wash vehicles and equipment, provided that there is no discharge of soaps, solvents, or detergents used for such purposes;
- e. Water used to control dust;

- f. Potable water including uncontaminated water line flushings;
 - g. External building washdown, provided soaps, solvents, and detergents are not used, and external surfaces do not contain hazardous substances;
 - h. Pavement wash waters, provided spills or leaks of toxic or hazardous materials have not occurred (unless all spill material has been removed) and where detergents (including biodegradable soy bean oils and biodegradable detergents) are not used. You are prohibited from directing pavement wash waters directly into any surface water, storm drain inlet, or storm water conveyance unless the conveyance is connected to a sediment basin, sediment trap, or similarly effective control for the pollutants present. Per 2.2.5.d., hosing of accumulated sediments on pavement into any storm water conveyance is prohibited;
 - i. Uncontaminated air conditioning or compressor condensate;
 - j. Uncontaminated, non-turbid discharges of ground water (from natural sources) or spring water; and,
 - k. Foundation or footing drains where flows are not contaminated with process materials such as solvents, contaminated ground water, or sediment from construction activity.
- 1.2.4.** Comingling of the non-storm water discharges above with other permitted discharges is also authorized.
- 1.2.5. Discharging of construction dewatering** (groundwater that intersects with excavation) must be permitted under UTG070000 (Construction Dewatering and Hydrostatic Test Permit), and the Municipal Separate Storm Sewer System (MS4) (of jurisdiction) notified of the discharge. Permitting is not required under UTG070000 if the construction dewatering does not leave the site (it is percolated into the ground on site).

1.3. PROHIBITED DISCHARGES.

- 1.3.1.** Wastewater from washing tools and vehicles after pouring, prepping, or finishing concrete.
- 1.3.2.** Wastewater from washing and cleanout of stucco, paint, concrete, form release oils, curing compounds, and other construction materials;
- 1.3.3.** Fuels, oils, or other pollutants used in vehicle and equipment operation and maintenance;
- 1.3.4.** Soaps, solvents, or detergents used in vehicle and equipment washing or external building washdown; and
- 1.3.5.** Toxic or hazardous substances from a spill or other release.

To prevent the above-listed prohibited non-storm water discharges, operators must comply with the applicable pollution prevention requirements in Part 2.3.

- 1.4. NOTICE OF INTENT (NOI).** To be covered under this permit, you must develop a SWPPP (see part 7.1), submit a complete and accurate NOI, and remit the permit fee. The permit fee covers a year of permit coverage. If a project extends more than a year the permit must be renewed and the permit fee must be remitted again.

There is a 60-day grace period after the permit expiration date where projects may be completed or the permit renewed.

All NOI applications and project storm water compliance plans must also be submitted to regulated MS4s (see the list of municipalities on the DWQ municipal storm water web site <https://deq.utah.gov/legacy/permits/water-quality/utah-pollutant-discharge-elimination-system/storm-water-municipal.htm>). Not all municipalities are regulated MS4s (see definitions Part 10).

1.4.1. How to Submit Your NOI. NOIs and permit fees may be submitted online at <https://secure.utah.gov/stormwater>. A paper copy of the NOI form may be downloaded from the DWQ construction storm water web site at <https://deq.utah.gov/legacy/permits/water-quality/utah-pollutant-discharge-elimination-system/storm-water-general-construction.htm>, of which the NOI form and permit fee may be mailed to:

Division of Water Quality
PO Box 144870
Salt Lake City, Utah 84114-4870

1.4.2. Start and End of Permit Coverage and Deadlines. Coverage under a permit must be obtained before soil disturbing activities begin. The permit is effective immediately after the NOI has been successfully entered into the storm water database and the permit fee is paid. Active coverage may be affected by the following conditions:

- a. a notice of termination (NOT) is submitted.
- b. the yearly permit fee is kept current and renewed year by year for the period of construction activity,
- c. when this general permit (UTRC00000) expires, if no arrangement has been made for continuing coverage, NOIs may need to be submitted for continuing coverage under a new or reissued replacement permit,
- d. coverage under the CGP is rescinded or revoked for the project site for administrative reasons for which the permittee will be notified in writing, or
- e. if all storm water discharges for the site are permitted under a different general or individual UPDES permit, this permit is terminated on the day the other permit coverage begins.

1.4.3. Exception to NOI Deadline for “Existing Permits”. Existing permits are construction projects with soil disturbances that require coverage under a UPDES construction storm water permit, and which had active coverage under UTRC00000 at the time of expiration of that general permit, or that received coverage before this permit was issued. Existing projects may be automatically covered under this permit. Permittees will be contacted with the email address listed on their NOI if further action is needed. **Existing projects have 3 months** from the issuance of this permit to update site storm water controls and the site SWPPP to meet requirements in this permit.

1.4.4. Continuation of Coverage After this Permit Expires. If this permit is not reissued or replaced by the expiration date, it will be administratively extended by the Director and remain in force and effect until issuance of a comparable CGP. Permit coverage will continue under this permit until the earliest of:

- a. authorization of, and an application process, is provided for coverage under a reissued or replacement version of this permit; or
- b. the permittee's submittal of a Notice of Termination; or
- c. the issuance of an individual permit or denial of coverage (see part 1.4.4 below) for the project's discharges.

DWQ reserves the right to modify or revoke and reissue this permit under UAC317-8-5.6, in which case you will be notified of any relevant changes to which you may be subject.

1.4.5. Procedures for Denial of Coverage. Following a submittal of a complete and accurate NOI, you may be notified in writing by DWQ that you are not covered, and that you must either apply for and/or obtain coverage under an individual UPDES permit or an alternate general UPDES permit. This notification will include a brief statement of the reasons for this decision and will provide application information. Any interested person may request that DWQ consider requiring an individual permit under this paragraph.

If you are already a permittee with coverage under this permit, the notice will set a deadline to file the permit application, and will include a statement that on the effective date of the individual UPDES permit or alternate general UPDES permit, as it applies to you, coverage under this general permit will terminate. DWQ may grant additional time to submit the application if requested. If you are covered under this permit and fail to submit an individual UPDES permit application or an NOI for an alternate general UPDES permit as required by DWQ, then the applicability of this permit to your site is terminated at the end of the day specified by DWQ as the deadline for application submittal. DWQ may take appropriate enforcement action for any unpermitted discharge. If you submit a timely permit application, then when an individual UPDES permit is issued to you or you are provided with coverage under an alternate general UPDES permit, your coverage under this permit is terminated on the effective date of the individual permit or date of coverage under the alternate general permit.

1.5. REQUIREMENT TO POST A NOTICE OF YOUR PERMIT COVERAGE All permitted sites must have a sign posted in a conspicuous, safe, publically accessible place and near the entrance to the project. The font on the sign must large enough for normal corrected vision to easily read the sign contents from a public right-of-way. At a minimum, the notice must include:

- 1.5.1.** the UPDES Permit tracking number,
- 1.5.2.** the name of a contact person for questions, SWPPP requests, or information about the project,
 - a. the contact phone number (must be available during business hours) or
 - b. an email address (must be checked and responded to within 24-hours on week days).

- 2. TECHNOLOGY-BASED EFFLUENT LIMITATIONS.** You must comply with the following technology-based effluent limitations in this Part.
- 2.1. GENERAL STORM WATER CONTROL DESIGN, INSTALLATION, AND MAINTENANCE REQUIREMENTS.** You must design, install, and maintain storm water controls required in Parts 2.2 and 2.3 to minimize the discharge of pollutants in storm water from construction activities. To meet this requirement, you must:
- 2.1.1. Account for the following factors in designing your storm water controls:**
- a. The expected amount, frequency, intensity, and duration of precipitation;
 - b. The nature of storm water runoff and run-on at the site, including factors such as expected flow from impervious surfaces, slopes, and site drainage features. You must design storm water controls to control storm water volume, velocity, and peak flow rates to minimize discharges of pollutants in storm water and to minimize channel and streambank erosion and scour in the immediate vicinity of discharge points; and
 - c. The soil type and range of soil particle sizes expected to be present on the site.
- 2.1.2. Design and install all storm water controls** in accordance with good engineering practices, including applicable design specifications (see manufacturer specifications and/or applicable erosion and sediment control manuals or ordinances – departures from such specifications must reflect good engineering practices and must be explained in your SWPPP).
- 2.1.3. Complete installation of storm water controls** by the time each phase of construction activities has begun.
- a. Before construction activity in any given portion of the site begins, install and make operational any downgradient sediment controls (e.g., buffers, perimeter controls, exit point controls, storm drain inlet protection).
 - b. Following the installation of storm water controls for the initial construction activities (e.g., clearing, grading, excavating), adjust storm water control and management strategies throughout the project to meet and match the needs for each phase of construction, if applicable, as the project progresses towards completion.
- 2.1.4. Ensure that all storm water controls are maintained, remain in effective operating condition during permit coverage, and are protected from activities that would reduce their effectiveness.**
- a. Comply with any specific maintenance requirements for the storm water controls listed in this permit. Regular maintenance is expected and is not limited to response actions from inspections or identified problems.
 - b. Follow maintenance recommendations from the manufacturer or utilize good engineering practices based on site conditions and document deviations from manufacture recommendations.
 - c. Any time maintenance issues are discovered in storm water controls, make repairs immediately if practical, prior to weather or activities utilizing the control, or within seven business days, whichever comes first.

- d. Any time you find that a storm water control needs to be installed (where none had previously been), replaced, or removed, you must record the corrective action as required in Part 5.

2.2. EROSION AND SEDIMENT CONTROL REQUIREMENTS. You must implement erosion and sediment controls in accordance with the following requirements to minimize the discharge of pollutants in storm water from construction activities.

2.2.1. Provide and maintain natural buffers and/or equivalent erosion and sediment controls when a water of the state is located within 50 feet of the site's earth disturbances. Additional guidance for buffers is provided in Appendix A.

- a. Compliance Alternatives. For any discharges to waters of the State located within 50 feet of your site's earth disturbances, you must comply with one of the following alternatives:
 - (1) Provide and maintain a 50-foot undisturbed natural buffer; or
 - (2) Provide and maintain an undisturbed natural buffer that is less than 50 feet and is supplemented by erosion and sediment controls that achieve, in combination, the sediment load reduction equivalent to a 50-foot undisturbed natural buffer; or
 - (3) If infeasible to provide and maintain an undisturbed natural buffer of any size, implement erosion and sediment controls to achieve the sediment load reduction equivalent to a 50-foot undisturbed natural buffer.

b. See Appendix A, Part A.2.2. for exceptions to the compliance alternatives.

2.2.2. Preserve naturally vegetated areas where possible and, if feasible, direct storm water to these areas to maximize storm water infiltration and filtering to reduce pollutant discharges.

2.2.3. Install sediment controls along any perimeter areas of the site that will receive pollutant discharges.

- a. Remove sediment before it has accumulated to the point where the control has become ineffective. Often that is one-half of the above-ground height of any perimeter control.
- b. **Exception.** For areas at "linear construction sites" (as defined in Part 10) where perimeter controls are infeasible (e.g., due to a limited or restricted right-of-way), implement other practices as necessary to minimize pollutant discharges to perimeter areas of the site.

2.2.4. Minimize sediment track-out.

- a. **Restrict vehicle use to properly designated exit points;**
- b. Use appropriate stabilization techniques at all points that exit onto paved roads³.
 - (1) **Exception:** Stabilization is not required for exit points at linear utility construction sites that are used only episodically and for very short durations over the life of the project, provided other exit point controls⁴ are implemented to minimize sediment track-out;

³ An example of appropriate stabilization techniques is the use of aggregate stone with an underlying geotextile or non-woven filter fabric, and turf mats.

- c. Implement additional track-out controls⁵ as necessary to ensure that sediment removal occurs prior to vehicle exit; and
- d. Where sediment has been tracked-out from your site onto paved roads, sidewalks, or other paved areas outside of your site, you must remove deposited sediment before it accumulates significantly and is tracked beyond the immediate vicinity of the project. Frequency of removal is dependent on site conditions, whatever is necessary to control off site tracking. . Remove the track-out by sweeping, shoveling, or vacuuming these surfaces, or by using other similarly effective means of sediment removal. You are prohibited from hosing or sweeping tracked-out sediment into any storm water conveyance, storm drain inlet, or water of the state⁶.

2.2.5. Manage stockpiles or land clearing debris piles composed, in whole or in part, of sediment and/or soil:

- a. Locate the piles outside of any natural buffers established under Part 2.2.1 and away from any storm water conveyances, drain inlets, and areas where storm water flow is concentrated;
- b. Install a sediment barrier along all downgradient perimeter areas;⁷
- c. For piles that will be unused for 14 or more days and are stored in areas that are being inspected at a reduced frequency due to temporary stabilization or frozen conditions (Part 4.4.1. and 4.4.3.), provide cover⁸ or appropriate temporary stabilization (consistent with Part 2.2.14);
- d. You are prohibited from hosing down or sweeping soil or sediment accumulated on pavement or other impervious surfaces into any storm water conveyance, storm drain inlet, or water of the state.
- e. Where practicable, contain and securely protect from wind.

2.2.6. Minimize dust. On areas of exposed soil, minimize the generation of dust through the appropriate application of water or other dust suppression techniques.

2.2.7. Minimize steep slope disturbances. Minimize the disturbance of “steep slopes” (as defined in Part 10).

2.2.8. Preserve native topsoil,⁹ unless infeasible.

⁴ Examples of other exit point controls include preventing the use of exit points during wet periods; minimizing exit point use by keeping vehicles on site to the extent possible; limiting exit point size to the width needed for vehicle and equipment usage; using scarifying and compaction techniques on the soil; and avoiding establishing exit points in environmentally sensitive areas (e.g., karst areas; steep slopes).

⁵ Examples of additional track-out controls include the use of wheel washing, rumble strips, and rattle plates.

⁶ Fine grains that remain visible (i.e., staining) on the surfaces of off-site streets, other paved areas, and sidewalks after you have implemented sediment removal practices are not a violation of Part 2.2.4.

⁷ Examples of sediment barriers include berms, dikes, fiber rolls, silt fences, sandbags, gravel bags, or straw bale.

⁸ Examples of cover include tarps, blown straw and hydromulching.

⁹ Stockpiling topsoil at off-site locations, or transferring topsoil to other locations, is an example of a practice that is consistent with the requirements in Part 2.2.8. Preserving native topsoil is not required where the intended function of a specific area of the site dictates that the topsoil be disturbed or removed. For example, some sites may be designed to be highly impervious after construction, and therefore little or no vegetation is intended to remain, or may not have space to stockpile native topsoil on site for later use, in which case, it may not be feasible to preserve topsoil.

2.2.9. Minimize soil compaction¹⁰ in areas of your site where final vegetative stabilization will occur or where infiltration practices will be installed:

- a. Restrict vehicle and equipment use in these locations to avoid soil compaction; and
- b. Before seeding or planting areas of exposed soil that have been compacted, use techniques that rehabilitate and condition the soils as necessary to support vegetative growth.

2.2.10. Protect storm drain inlets.

- a. Install inlet protection measures that remove sediment from discharges prior to entry into any storm drain inlet that carries storm water flow from your site to a surface water of the state, provided you have authority to access the storm drain inlet;¹¹ and
- b. Clean, or remove and replace, the protection measures as sediment accumulates, the filter becomes clogged, and/or performance is compromised. Where there is evidence of sediment accumulation adjacent to the inlet protection measure, remove the deposited sediment by the end of the same business day in which it is found.

2.2.11. Minimize erosion of storm water conveyance channels and their embankments, outlets, adjacent streambanks, slopes, and downstream waters. Use erosion controls and velocity dissipation devices¹² within and along the length of any storm water conveyance channel and at any outlet to slow down runoff to minimize erosion.

2.2.12. If you install a sediment basin or similar impoundment:

- a. Situate the basin or impoundment outside of any water of the state and any natural buffers established under Part 2.2.1;
- b. Design the basin or impoundment to avoid collecting water from wetlands;
- c. Design the basin or impoundment to provide storage for either:
 - (1) The calculated volume of runoff from a 2-year, 24-hour storm; or
 - (2) 3,600 cubic feet per acre drained.
- d. Utilize outlet structures that withdraw water from near the surface of the sediment basin or similar impoundment, unless infeasible;¹³
- e. Use erosion controls and velocity dissipation devices to prevent erosion at inlets and outlets; and
- f. Remove accumulated sediment to maintain at least one-half of the design capacity and conduct all other appropriate maintenance to ensure the basin or impoundment remains in effective operating condition.

¹⁰ Minimizing soil compaction is not required where the intended function of a specific area of the site dictates that it be compacted.

¹¹ Inlet protection measures can be removed in the event of flood conditions or to prevent erosion

¹² Examples of velocity dissipation devices include check dams, sediment traps, riprap, and grouted riprap at outlets.

¹³ The circumstances in which it is infeasible to design outlet structures in this manner are rare. A possible exception is dealing with or treating for temperature, but there may be other reasons. If you determine that it is infeasible to meet this requirement, you must provide documentation in your SWPPP to support your determination, including the specific conditions or time periods when this exception will apply.

2.2.13. If using treatment chemicals (e.g., polymers, flocculants, coagulants):

- a. **Use conventional erosion and sediment controls before and after the application of treatment chemicals.** Chemicals may only be applied where treated storm water is directed to a sediment control (e.g., sediment basin, perimeter control) before discharge.
- b. **Select appropriate treatment chemicals.** Chemicals must be appropriately suited to the types of soils likely to be exposed during construction and present in the discharges being treated (i.e., the expected turbidity, pH, and flow rate of storm water flowing into the chemical treatment system or area).
- c. **Minimize discharge risk from stored chemicals.** Store all treatment chemicals in leak-proof containers that are kept under storm-resistant cover and surrounded by secondary containment structures (e.g., spill berms, decks, spill containment pallets), or provide equivalent measures designed and maintained to minimize the potential discharge of treatment chemicals in storm water or by any other means (e.g., storing chemicals in a covered area, having a spill kit available on site and ensuring personnel are available to respond expeditiously in the event of a leak or spill).
- d. **Comply with state/local requirements.** Comply with applicable state and local requirements regarding the use of treatment chemicals.
- e. **Use chemicals in accordance with good engineering practices and specifications of the chemical provider/supplier.** Use treatment chemicals and chemical treatment systems in accordance with good engineering practices, and with dosing specifications and sediment removal design specifications provided by the provider/supplier of the applicable chemicals, or document in your SWPPP specific departures from these specifications and how they reflect good engineering practice. Consider changing site conditions that may affect dosing levels such as temperature.
- f. **Ensure proper training.** Ensure that all persons who handle and use treatment chemicals at the construction site are provided with appropriate, product-specific training. Among other things, the training must cover proper dosing requirements.
- g. **Perform additional measures specified by DWQ for the authorized use of cationic chemicals.** If you have been authorized to use cationic chemicals at your site pursuant to Part 1.1.4.c, you must perform all additional measures as conditioned by your authorization to ensure that the use of such chemicals will not cause an exceedance of water quality standards or harm fish populations.

2.2.14. Stabilize exposed portions of the site. Implement and maintain stabilization measures (e.g., seeding protected by erosion controls until vegetation is established, sodding, mulching, erosion control blankets, hydromulch, gravel) that minimize erosion from exposed portions of the site in accordance with Parts 2.2.14.a and 2.2.14.b.

a. **Stabilization Deadlines:**

- (1) Initiate the installation of stabilization measures in any areas of exposed soil where construction activities have permanently ceased or will be temporarily inactive for 14 or more calendar days as soon as possible and prior to the end of the 14th day of inactivity; and

- (2) Complete the installation of stabilization measures as soon as practicable, but no later than 14 calendar days after stabilization has been initiated.¹⁴

- (3) **Exceptions:**

- (i) Arid, semi-arid, and drought-stricken areas¹⁵ (as defined in Part 10). Where a project is an arid, semi-arid, or a seasonally dry period or a period in which drought is occurring, and vegetative stabilization measures are being used:

- (1) Initiate as soon as practicable and, within 14 calendar days of a temporary or permanent cessation of work in any portion of your site, complete the installation of temporary non-vegetative stabilization measures to the extent necessary to prevent erosion;¹⁶

- (2) As soon as practicable, given conditions or circumstances on the site, complete all activities necessary to seed or plant the area to be stabilized; and

- (3) If construction is occurring during the seasonally dry period¹⁷, indicate in your SWPPP the beginning and ending dates of the seasonally dry period and your site conditions. Also include the schedule you will follow for initiating and completing vegetative stabilization.

- (ii) **Discharges to a sediment- or nutrient-impaired water** (a water having a TMDL identifying sediment or nutrients as the cause of impairment) or to a water that is high quality for antidegradation purposes (see part 3). Complete stabilization as soon as practicable, but no later than seven (7) calendar days after stabilization has been initiated.

- b. **Final Stabilization Criteria** (for any areas not covered by permanent structures):

- (i) Establish uniform, perennial vegetation (i.e., evenly distributed, without large bare areas) that provides 70 percent or more of the vegetative cover that was provided by vegetation prior to commencing earth-disturbing activities; and/or

- (ii) Implement permanent non-vegetative stabilization measures¹⁸ to provide effective cover.

- (iii) **Exceptions:**

- (1) **Arid, semi-arid, and drought-stricken areas** (as defined in Part 10). Final stabilization is met if the area has been seeded or planted in a manner that vegetation is expected to be

¹⁴ If vegetative stabilization measures are being implemented, stabilization is considered “installed” when all activities necessary to seed or plant the area are completed. If non-vegetative stabilization measures are being implemented, stabilization is considered “installed” when all such measures are implemented or applied.

¹⁵ If you are in an area receiving more than 20 inches of average annual precipitation that is in a drought (as determined by the NOAA drought predictor <http://www.cpc.ncep.noaa.gov/products/Drought/>) and a seasonal dry period, to comply with drought conditions you must identify the normal seasonal dry period in the SWPPP.

¹⁶ The extent necessary to prevent erosion in arid and semi-arid areas means for visually flat areas, stabilization is not required (roughly from 0 percent up to 5 percent) unless an erosion concern exists. Areas with slopes roughly 5 percent to 20 percent must have, at minimum, controls to reduce storm water velocities to a point that erosion is controlled. Over a 20 percent slope requires soil surface stabilization. The amount of stabilization provided must increase commensurately with increasingly steeper slopes.

¹⁷ The lower elevations of the Wasatch Front are semi-arid, the seasonal dry period for the Wasatch Front is June, July, and August.

¹⁸ Examples of permanent non-vegetative stabilization measures include riprap, gravel, gabions, and geotextiles.

established within three (3) years which provides 70 percent or more of the cover that was provided by vegetation prior to commencing earth disturbing activities and, to the extent necessary to prevent erosion on the seeded or planted area, non-vegetative erosion controls meet standards in footnote 16.

- (2) Disturbed areas on agricultural land that are restored to their preconstruction agricultural use. The Part 2.2.14b final stabilization criteria does not apply.
- (3) Areas that need to remain disturbed. In limited circumstances, stabilization may not be required if the intended function of a specific area of the site necessitates that it remain disturbed, and only the minimum area needed remains disturbed (e.g., dirt access roads, utility pole pads, areas being used for storage of vehicles, equipment, materials).

2.3. POLLUTION PREVENTION REQUIREMENTS: Implement pollution prevention controls in accordance with the following requirements to minimize the discharge of pollutants in storm water and to prevent the discharge of pollutants from spilled or leaked materials from construction activities.

2.3.1. For equipment and vehicle fueling and maintenance:

- a. Provide an effective means of eliminating the discharge of spilled or leaked chemicals, including fuels and oils, from these activities;¹⁹
- b. If applicable, comply with the Spill Prevention Control and Countermeasures (SPCC) requirements in 40 CFR part 112 and Section 311 of the CWA;
- c. Ensure adequate supplies are available at all times to handle spills, leaks, and disposal of used liquids;
- d. Use drip pans and absorbents under or around leaky vehicles;
- e. Dispose of or recycle oil and oily wastes in accordance with other federal, state, tribal, or local requirements; and
- f. Clean up spills or contaminated surfaces immediately, using dry clean up measures (do not clean contaminated surfaces by hosing the area down), and eliminate the source of the spill to prevent a discharge or a continuation of an ongoing discharge.

2.3.2. For equipment and vehicle washing:

- a. Provide an effective means of minimizing the discharge of pollutants from equipment and vehicle washing, wheel wash water, and other types of wash waters;²⁰

¹⁹ Examples of effective means include:

- Locating activities away from waters of the state and storm water inlets or conveyances so that storm water coming into contact with these activities cannot reach waters of the state;
- Providing secondary containment (e.g., spill berms, decks, spill containment pallets) and cover where appropriate; and
- Having a spill kit available on site and ensuring personnel are available to respond expeditiously in the event of a leak or spill.

- b. Ensure there is no discharge of soaps, solvents, or detergents in equipment and vehicle wash water; and
- c. For storage of soaps, detergents, or solvents, provide either (1) cover (e.g., plastic sheeting, temporary roofs) to minimize the exposure of these detergents to precipitation and to storm water, or (2) a similarly effective means designed to minimize the discharge of pollutants from these areas.

2.3.3. For storage, handling, and disposal of building products and materials:

- a. For building materials and building products²¹ that have the potential to mobilize or release pollutants, provide either (1) cover (e.g., plastic sheeting, temporary roofs) to minimize the exposure of these products to precipitation and to storm water, or (2) a similarly effective means designed to minimize the discharge of pollutants from these areas.
- b. **For pesticides, herbicides, insecticides, fertilizers, and landscape materials:**
 - (1) In storage areas, provide either (1) cover (e.g., plastic sheeting, temporary roofs) to minimize the exposure of these chemicals to precipitation and to storm water, or (2) a similarly effective means designed to minimize the discharge of pollutants from these areas; and
 - (2) Comply with all application and disposal requirements included on the registered pesticide, herbicide, insecticide, and fertilizer label (see also Part 2.3.5).
- c. **For diesel fuel, oil, hydraulic fluids, other petroleum products, and other chemicals:**
 - (1) Store chemicals in water-tight containers, and provide either (1) cover (e.g., plastic sheeting, temporary roofs) to minimize the exposure of these containers to precipitation and to storm water, or (2) a similarly effective means designed to minimize the discharge of pollutants from these areas (e.g., having a spill kit available on site and ensuring personnel are available to respond expeditiously in the event of a leak or spill), or provide secondary containment (e.g., spill berms, decks, spill containment pallets); and
 - (2) Clean up spills immediately, using dry clean-up methods where possible, and dispose of used materials properly. You are prohibited from hosing the area down to clean surfaces or spills. Eliminate the source of the spill to prevent a discharge or a furtherance of an ongoing discharge.
- d. **For hazardous or toxic wastes:**²²
 - (1) Separate hazardous or toxic waste from construction and domestic waste;
 - (2) Store waste in sealed containers, which are constructed of suitable materials to prevent leakage and corrosion, and which are labeled in accordance with applicable Resource

²⁰ Examples of effective means include locating activities away from waters of the state and storm water inlets or conveyances and directing wash waters to a sediment basin or sediment trap, using filtration devices, such as filter bags or sand filters, or using other similarly effective controls.

²¹ Examples of building materials and building products typically present at construction sites include asphalt sealants, copper flashing, roofing materials, adhesives, concrete admixtures, and gravel and mulch stockpiles.

²² Examples of hazardous or toxic waste that may be present at construction sites include paints, caulks, sealants, fluorescent light ballasts, solvents, petroleum-based products, wood preservatives, additives, curing compounds, and acids.

Conservation and Recovery Act (RCRA) requirements and all other applicable federal, state, tribal, or local requirements;

- (3) Store all outside containers within appropriately-sized secondary containment (e.g., spill berms, decks, spill containment pallets) to prevent spills from being discharged, or provide a similarly effective means designed to prevent the discharge of pollutants from these areas (e.g., storing chemicals in a covered area, having a spill kit available on site);
- (4) Dispose of hazardous or toxic waste in accordance with the manufacturer's recommended method of disposal and in compliance with federal, state, tribal, and local requirements;
- (5) Clean up spills immediately, using dry clean-up methods, and dispose of used materials properly. You are prohibited from hosing the area down to clean surfaces or spills. Eliminate the source of the spill to prevent a discharge or a furtherance of an ongoing discharge; and
- (6) Follow all other federal, state, tribal, and local requirements regarding hazardous or toxic waste.

e. **For construction and domestic wastes:**²³

- (1) Provide waste containers (e.g., dumpster, trash receptacle) of sufficient size and number to contain construction and domestic wastes;
- (2) Provide containment or cover for waste that is blowable or that can leach nutrients, metals, pesticides, herbicides, oil, grease, bacteria, or other pollutants;
- (3) On business days, clean up and dispose of waste in designated waste containers; and
- (4) Clean up immediately if containers overflow.

f. **For sanitary waste**, position portable toilets so that they are secure and will not be tipped or knocked over. Locate them away from waters of the state and, when possible, at least 10 feet from any storm water conveyance, inlet, curb and gutter, or conduit to a waterway. If it is not possible to maintain at least 10 feet of separation, evaluate the need for additional controls such as secondary containment, additional surface preparation, or berms and implement as appropriate.

2.3.4. For washing applicators and containers used for stucco, paint, concrete, form release oils, curing compounds, or other materials:

- a. Direct wash water into a leak-proof container or leak-proof and lined pit designed so that no overflows can occur due to inadequate sizing or precipitation;
- b. Handle washout or cleanout wastes as follows:
 - (1) Do not dump liquid wastes in storm sewers or waters of the state;
 - (2) Dispose of liquid wastes properly²⁴; and

²³ Examples of construction and domestic waste include packaging materials, scrap construction materials, masonry products, timber, pipe and electrical cuttings, plastics, styrofoam, concrete, demolition debris; and other trash or building materials.

- (3) Remove and dispose of hardened concrete waste consistent with your handling of other construction wastes in Part 2.3.3; and
- c. Locate any washout or cleanout activities as far away as possible from waters of the state and storm water inlets or conveyances, and, to the extent feasible, determine areas to be used for these activities and conduct such activities only in these areas.

2.3.5. For the application of fertilizers:

- a. Apply at a rate and in amounts consistent with manufacturer's specifications, or document in the SWPPP departures from the manufacturer specifications where appropriate in accordance with Part 7.3.5.b.(5)(ix);
- b. Apply at the appropriate time of year for your location, and preferably timed to coincide as closely as possible to the period of maximum vegetation uptake and growth;
- c. Avoid applying before heavy rains that could cause excess nutrients to be discharged;
- d. Never apply to frozen ground;
- e. Never apply to storm water conveyance channels; and
- f. Follow all other federal, state, tribal, and local requirements regarding fertilizer application.

2.3.6. Emergency Spill Notification Requirements: Discharges of toxic or hazardous substances from a spill or other release are prohibited (see Part 1.3). Where a leak, spill, or other release containing a hazardous substance or oil in an amount equal to or in excess of a reportable quantity established under either 40 CFR 110, 40 CFR 117, or 40 CFR 302 occurs during a 24-hour period, you must notify the National Response Center (NRC) at (800) 424-8802 in accordance with the requirements of 40 CFR 110, 40 CFR 117, and 40 CFR 302 as soon as you have knowledge of the release. You must also, within seven (7) calendar days of knowledge of the release, provide a description of the release, the circumstances leading to the release, and the date of the release. State, tribal, or local requirements may necessitate additional reporting of spills or discharges to local emergency response, public health, or drinking water supply agencies.

2.3.7. Construction Dewatering Requirements: Water or accumulated storm water that is removed from excavations, trenches, foundations, vaults, or other similar points of accumulation must be permitted by UPDES permit UTG070000 (UPDES Construction Dewatering and Hydrostatic Test Permit) in accordance with Part 1.2.5., unless it can be managed on site. An option for on site management is percolation of the water back into the ground (assuming it is uncontaminated).

²⁴ Proper disposal of liquid waste: 1) evaporate the waste and dispose of the residual solids with other solid waste, 2) have a liquid waste hauler for wash water haul it off and dispose of it, 3) settle it and pretreat it if necessary with arrangements to discharge the liquid waste to a treatment plant that has the ability to treat it and dispose of it.

3. WATER QUALITY-BASED EFFLUENT LIMITATIONS.

3.1. GENERAL EFFLUENT LIMITATION TO MEET APPLICABLE WATER QUALITY STANDARDS.

Discharges must be controlled as necessary to meet applicable water quality standards. DWQ expects that compliance with the conditions in this permit will result in storm water discharges being controlled as necessary to meet applicable water quality standards. If at any time you become aware, or DWQ determines, that discharges are not being controlled as necessary to meet applicable water quality standards, you must take corrective action as required in Parts 5.1 and 5.2, and document the corrective actions as required in Part 5.4.

DWQ may insist that you install additional controls on a site-specific basis, or require you to obtain coverage under an individual permit, if information in your NOI or from other sources indicates that your discharges are not controlled as necessary to meet applicable water quality standards. This includes situations where additional controls are necessary to comply with a wasteload allocation in an EPA-established or approved TMDL.

The NOI process requires that you determine if the watershed that you discharge into is impaired or if it is considered high quality. Only the first surface water you discharge to is used when determining if your discharge enters an impaired or high quality waterbody. For discharges that enter a storm water system prior to discharge, the first water of the state to which you discharge is the waterbody that receives the storm water discharge from the storm sewer system. Please refer to water quality information at <http://mapserv.utah.gov/surfacewaterquality/>

Each of these cases, impaired or high quality, may require an extra effort to maintain water quality standards. An impaired water body can have an approved TMDL (see Part 10 for definitions) or it can be on the list waiting a TMDL study. An EPA-approved TMDL is a water quality standard. If your project is in an area covered by an EPA-approved TMDL that has sediment or nutrients (particularly phosphorus) identified as the pollutant(s) of concern, you must provide an extra effort to prevent sediment from leaving the site. Nutrients are a component in topsoil from natural biotic systems. Nitrogen (a nutrient) is infused into the soil from biotic systems but also at times from the atmosphere during certain weather conditions. Some soils have phosphorus (a nutrient) from geologic formations in addition to biotic sources. Special efforts including site controls and management efforts must be employed for impaired or high quality waters, but especially for areas with TMDLs identifying sediment or nutrients as the pollutants of concern. Your SWPPP must show the special efforts you are taking for sensitive water bodies.

3.2. DISCHARGE LIMITATIONS FOR SITES DISCHARGING TO SENSITIVE WATERS²⁵

For any portion of the site that discharges to a sediment or nutrient-impaired water or to a water that is identified as impaired or high quality you must comply with the inspection frequency specified in 4.3 and you must comply with the stabilization deadline specified in Part 2.2.14.²⁶

²⁵ Your construction site will be considered to discharge to an impaired or high quality water if the first water to which you discharge is an impaired or high quality water for the pollutants contained in the discharge from your site. For discharges that enter a storm sewer system prior to discharge, the first water to which you discharge is the waterbody that receives the storm water discharge from the storm sewer system.

If you discharge to a water that is impaired for a parameter other than sediment or nutrients, you must address that parameter in your SWPPP if that pollutant has a presence in the construction process for your site. If the impaired parameter is naturally occurring in soils, it is assumed that the erosion control BMPs required by this permit will address the concern and it does not need to be addressed in the SWPPP as a pollutant source. You must deploy whatever control mechanisms that's needed to limit the discharge of that pollutant to meet water quality standards. This includes, if requested by DWQ, comparing the load discharged from the site for that pollutant to ensure it does not exceed a wasteload allocation for that pollutant in the applicable TMDL for the watershed.

²⁶ If you qualify for any of the reduced inspection frequencies in Part 4.4, you may conduct inspections in accordance with Part 4.4 for any portion of your site that discharges to a sensitive water.

4. SITE INSPECTION REQUIREMENTS.

4.1. PERSON(S) RESPONSIBLE FOR INSPECTING THE SITE. The person(s) inspecting your site may be a person on your staff or a third party you hire to conduct such inspections. You are responsible for ensuring that the person who conducts inspections is a “qualified person” and currently certified.

a. A “qualified person” is a person knowledgeable in the principles and practice of erosion and sediment controls and pollution prevention, who possesses the skills to assess conditions at the construction site that could impact storm water quality, and the skills to assess the effectiveness of any storm water controls selected and installed to meet the requirements of this permit, such as but not limited to the following:

- (1) Utah Registered Storm Water Inspector (RSI)
- (2) Certified Professional in Erosion and Sediment Control (CPESC)
- (3) Certified Professional in Storm Water Quality (CPSWQ)
- (4) Certified Erosion, Sediment, and Storm Water Inspector (CESSWI)
- (5) Certified Inspector of Sediment and Erosion Control (CISEC)
- (6) National Institute for Certification in Engineering Technologies, Erosion and Sediment Control, Level 3 (NICET)
- (7) Utah Department of Transportation Environmental Control Supervisor (ECS)

4.2. FREQUENCY OF INSPECTIONS.²⁷ At a minimum, you must conduct a site inspection in accordance with one of the two schedules listed below, unless you are subject to the Part 4.3 site inspection frequency for discharges to sensitive waters or qualify for a Part 4.4 reduction in the inspection frequency:

4.2.1. At least once every seven (7) calendar days; or

4.2.2. Once every 14 calendar days and within 24 hours of the occurrence of a storm event of 0.50 inches or greater, or the occurrence of runoff from snowmelt sufficient to cause a discharge.²⁸ To determine if a storm event of 0.50 inches or greater has occurred on your site, you must either keep a properly maintained rain gauge on your site, or obtain the storm event information from a weather station that is representative of your location. For any day of rainfall during normal business hours that measures 0.50 inches or greater, you must record the total rainfall measured for that day in accordance with Part 4.7.1.d.

4.3. INCREASE IN INSPECTION FREQUENCY FOR SITES DISCHARGING TO SENSITIVE WATERS. For any portion of the site that discharges to a sediment or nutrient-

²⁷ Inspections are only required during the site’s normal working hours.

²⁸ “Within 24 hours of the occurrence of a storm event” means that you must conduct an inspection within 24 hours once a storm event has produced 0.50 inches within a 24-hour period, even if the storm event is still continuing. Thus, if you have elected to inspect bi-weekly in accordance with Part 4.2.2 and there is a storm event at your site that continues for multiple days, and each day of the storm produces 0.50 inches or more of rain, you must conduct an inspection within 24 hours of the first day of the storm and within 24 hours after the end of the storm.

impaired water or to a high quality water (see Part 3), instead of the inspection frequency specified in Part 4.2, you must conduct inspections in accordance with the following inspection frequencies:

Once every seven (7) calendar days and within 24 hours of the occurrence of a storm event of 0.50 inches or greater, or the occurrence of runoff from snowmelt sufficient to cause a discharge. To determine if a storm event of 0.50 inches or greater has occurred on your site, you must either keep a properly maintained rain gauge on your site, or obtain the storm event information from a weather station that is representative of your location. For any day of rainfall during normal business hours that measures 0.50 inches or greater, you must record the total rainfall measured for that day in accordance with Part 4.7.1d.

4.4. REDUCTIONS IN INSPECTION FREQUENCY.

4.4.1. STABILIZED AREAS.

- a. **Temporarily Stabilized Areas.** You may reduce the frequency of inspections to twice per month for the first month, no more than 14 calendar days apart, then once per month in any area of your site where the stabilization steps in part 2.2.14.a. have been completed. If construction activity resumes in this portion of the site at a later date, the inspection frequency immediately increases to that required in Parts 4.2 and 4.3, as applicable. You must document the beginning and ending dates of this period in your SWPPP.
- b. **Permanently Stabilized Areas.** Inspections requirements are suspended.
- c. **Exception For “Linear Construction Sites”** (as defined in Part 10) where disturbed portions have undergone final stabilization at the same time active construction continues on others, you may reduce the frequency of inspections to twice per month for the first month, no more than 14 calendar days apart, in any area of your site where the stabilization steps in 2.2.14.a have been completed. After the first month, inspect once more within 24 hours of the occurrence of a storm event of 0.50 inches or greater. If there are no issues or evidence of stabilization problems, you may suspend further inspections. If “wash-out” of stabilization materials and/or sediment is observed, following re-stabilization, inspections must resume at the inspection frequency required in Part 4.4.1.a. Inspections must continue until final stabilization is visually confirmed following a storm event of 0.50 inches or greater.

4.4.2. ARID, SEMI-ARID (as defined in Part 10). For inspection frequencies (shown below) where it is required to inspect after a storm event, to determine if a storm event of 0.50 inches or greater has occurred on your site you must either keep a properly maintained rain gauge on your site or obtain the storm event information from a weather station that is representative of your location.

- a. **Arid Areas:** Inspections are required once a month and within 24 hours of the occurrence of a storm event of 0.50 inches or greater.
- b. **Semi-Arid Areas:** Inspections are the same as in parts 4.2.1 and 4.2.2 except for the seasonally dry times of the year where they go to once a month and within 24 hours of the occurrence of a

storm event of 0.50 inches or greater.²⁹ Where the inspection frequency changes to once a month the SWPPP must show the reference for the seasonally dry time period.

4.4.3. Frozen conditions

- a. If you are suspending construction activities due to frozen conditions, you may temporarily suspend inspections on your site until thawing conditions (as defined in Part 10) begin to occur if:
 - (1) Runoff is unlikely due to continuous frozen conditions that are likely to continue at your site for at least three (3) months based on historic seasonal averages. If unexpected weather conditions (such as above freezing temperatures or rain events) make discharges likely, you must immediately resume your regular inspection frequency as described in Parts 4.2 and 4.3, as applicable;
 - (2) Land disturbances have been suspended; and
 - (3) Disturbed areas of the site have been stabilized, where possible, in accordance with Part 2.2.14.a.
- b. If you are still conducting construction activities during frozen conditions, you may reduce your inspection frequency to once per month if:
 - (1) Runoff is unlikely due to continuous frozen conditions that are likely to continue at your site for at least three (3) months based on historic seasonal averages. If unexpected weather conditions (such as above freezing temperatures or rain events) make discharges likely, you must immediately resume your regular inspection frequency as described in Parts 4.2 and 4.3, as applicable; and
 - (2) Except for areas in which you are actively conducting construction activities, disturbed areas of the site have been stabilized in accordance with Part 2.2.14.a.

You must document the beginning and ending dates of this period in your SWPPP.

4.5. AREAS THAT MUST BE INSPECTED: During your site inspection, you must at a minimum inspect the following areas of your site:

- 4.5.1.** All areas that have been cleared, graded, or excavated and that have not yet completed stabilization consistent with Part 2.2.14.a;
- 4.5.2.** All storm water controls (including pollution prevention controls) installed at the site to comply with this permit;³⁰
- 4.5.3.** Material, waste, borrow, and equipment storage and maintenance areas that are covered by this permit;
- 4.5.4.** All areas where storm water typically flows within the site, including drainage ways designed to divert, convey, and/or treat storm water;

²⁹ The Seasonally dry period for the semi-arid areas on the Wasatch Front is June, July, and August. For other areas there are a few internet sites where it is possible to look up the annual rainfall for an area.

³⁰ This includes the requirement to inspect for sediment that has been tracked out from the site onto paved roads, sidewalks, or other paved areas consistent with Part 2.2.4.

- 4.5.5. All points of discharge from the site; and
- 4.5.6. All locations where stabilization measures have been implemented.
- 4.5.7. You are not required to inspect areas that, at the time of the inspection, are considered unsafe to your inspection personnel.
- 4.6. **REQUIREMENTS FOR INSPECTIONS;** During your site inspection, you must at a minimum:
 - 4.6.1. Check whether all storm water controls (i.e., erosion and sediment controls and pollution prevention controls) are properly installed, appear to be operational, and are working as intended to minimize pollutant discharges. Consider what has caused a BMP's failure if it is not operational;
 - 4.6.2. Check for the presence of conditions that could lead to spills, leaks, or other accumulations of pollutants on the site;
 - 4.6.3. Identify any locations where new or modified storm water controls are necessary to meet the requirements of Parts 2 and/or 3;
 - 4.6.4. Check for signs of visible erosion and sedimentation (i.e., sediment deposits) that have occurred and are attributable to your discharge at points of discharge and, if applicable, the banks of any waters of the state flowing within or immediately adjacent to the site;
 - 4.6.5. Identify any incidents of noncompliance observed;
 - 4.6.6. If a discharge is occurring during your inspection:
 - a. Identify all discharge points at the site; and
 - b. Observe and document the visual quality of the discharge, and take note of the characteristics of the storm water discharge, including color; odor; floating, settled, or suspended solids; foam; oil sheen; and other indicators of storm water pollutants.
 - 4.6.7. Based on the results of your inspection, complete any necessary maintenance under Part 2.1.4 and corrective action under Part 5.
- 4.7. **INSPECTION REPORT**³¹
 - 4.7.1. You must complete an inspection report within 24 hours of completing any site inspection. Each inspection report must include the following:
 - a. The inspection date;
 - b. The UPDES CGP permit tracking number;
 - c. Names and titles of personnel making the inspection;
 - d. A summary of your inspection findings, covering at a minimum the observations you made in accordance with Part 4.6, including any necessary maintenance or corrective actions;
 - e. If you are inspecting your site at the frequency specified in Part 4.2.2, Part 4.3, Part 4.4.1.c, Part 4.4.2.a, or Part 4.4.2.b and you conducted an inspection because of rainfall measuring 0.50

³¹ See DWQ construction storm water web page for ideas and examples of self-inspection forms.

inches or greater, you must include the applicable rain gauge or weather station readings that triggered the inspection; and

- f. If you determined that it is unsafe to inspect a portion of your site, you must describe the reason you found it to be unsafe and specify the locations to which this condition applies.
- 4.7.2. Each inspection report must be signed in accordance with 9.16(1)b. of this permit.
- 4.7.3. You must keep a copy, in paper or electronic form, of all inspection reports at the site or at an easily accessible location, so that it can be made available at the time of an on-site inspection or upon request by DWQ, a local municipality of jurisdiction, or by the EPA.
- 4.7.4. You must retain all inspection reports completed for this Part for at least three (3) years from the date that your permit coverage expires or is terminated.
- 4.8. **INSPECTIONS BY DWQ MS4 OR EPA:** You must allow an authorized representative of DWQ, the MS4 of jurisdiction or the EPA to conduct the following activities at reasonable times. To the extent that you are utilizing shared controls that are not on site to comply with this permit, you must make arrangements for DWQ to have access at all reasonable times to those areas where the shared controls are located.
 - 4.8.1. Enter onto all areas of the site, including any construction support activity areas covered by this permit, any off-site areas where shared controls are utilized to comply with this permit, discharge locations, adjoining waterbodies, and locations where records are kept under the conditions of this permit;
 - 4.8.2. Access and copy any records that must be kept under the conditions of this permit;
 - 4.8.3. Inspect your construction site, including any construction support activity areas covered by this permit (see Part 1.2.2), any storm water controls installed and maintained at the site, and any off-site shared controls utilized to comply with this permit; and
 - 4.8.4. Sample or monitor for the purpose of ensuring compliance.

5. CORRECTIVE ACTIONS

5.1. CONDITIONS TRIGGERING CORRECTIVE ACTION: You must take corrective action to address any of the following conditions identified at your site:

- 5.1.1. A storm water control needs repair or replacement (beyond routine maintenance required under Part 2.1.4); or
- 5.1.2. A storm water control necessary to comply with the requirements of this permit was never installed, or was installed incorrectly; or
- 5.1.3. Your discharges are causing an exceedance of applicable water quality standards; or
- 5.1.4. A prohibited discharge has occurred (see Part 1.3).

5.2. CORRECTIVE ACTION DEADLINES: For any corrective action triggering conditions in Part 5.1, you must:

- 5.2.1. When site conditions warrant immediate attention, take all reasonable steps to minimize or prevent the discharge of pollutants until a permanent solution for the problem is installed and made operational;
- 5.2.2. When the problem does not require a new or replacement control or significant repair, the corrective action must be completed by the close of the next business day;
- 5.2.3. When the problem requires a new or replacement control or significant repair, the corrective action must be completed no later than seven (7) calendar days from the time of discovery. If it is infeasible to complete the installation or repair within seven (7) calendar days (e.g., due to availability of materials, excessive costs to expedite shipping or activities, or lengthy installation times) you must document in your records why it is infeasible and provide a reasonable correction schedule.

5.3. CORRECTIVE ACTION REQUIRED BY DWQ: You must comply with any corrective actions required by DWQ as a result of permit violations found during an inspection carried out under Part 4.8.

5.4. CORRECTIVE ACTION REPORT: For each corrective action taken in accordance with this Part, you must complete a report in accordance with the following:

- 5.4.1. Within 24 hours of identifying the corrective action condition, document the specific condition and the date and time it was identified.
- 5.4.2. Within 24 hours of the observed completion of a corrective action and in accordance with the deadlines in Part 5.2, document the actions taken to address the condition, including the date and whether any SWPPP modifications are required.
- 5.4.3. Where these actions result in changes to any of the storm water controls or procedures documented in your SWPPP, you must modify your SWPPP (and SWPPP map) accordingly within seven (7) calendar days of completing this work.
- 5.4.4. You must keep a copy of all corrective action reports at the site or at an easily accessible location, so that it can be made available at the time of an on-site inspection or upon request by

DWQ. Corrective action reports may be maintained and made available in paper or electronically.

- 5.4.5.** You must retain all corrective action reports completed for this Part for at least three (3) years from the date that your permit coverage expires or is terminated.

6. STAFF TRAINING REQUIREMENTS

Each operator, or group of multiple operators, must assemble a “storm water team” to carry out compliance activities associated with the requirements in this permit.

- 6.1. PRIOR TO THE COMMENCEMENT OF CONSTRUCTION ACTIVITIES**, you must ensure that the following personnel³² on the storm water team understand the requirements of this permit and their specific responsibilities with respect to those requirements:
- 6.1.1.** Personnel who are responsible for the design, installation, maintenance, and/or repair of storm water controls (including pollution prevention controls);
 - 6.1.2.** Personnel responsible for the application and storage of treatment chemicals (if applicable);
 - 6.1.3.** Personnel who are responsible for conducting inspections as required in Part 4.1; and
 - 6.1.4.** Personnel who are responsible for taking corrective actions as required in Part 5.
- 6.2. YOU ARE RESPONSIBLE FOR ENSURING THAT ALL ACTIVITIES ON THE SITE COMPLY** with the requirements of this permit. You are not required to provide formal training for subcontractors or other outside service providers, but you must ensure that such personnel understand any requirements of this permit that may be affected by the work they are subcontracted to perform. You should document that you have explained or have given subcontractors information about how to perform their work in compliance with the SWPPP.
- 6.3. AT A MINIMUM, MEMBERS OF THE STORM WATER TEAM MUST BE TRAINED** to understand the following if related to the scope of their job duties (e.g., only personnel responsible for conducting inspections need to understand how to conduct inspections):
- 6.3.1.** The permit deadlines associated with installation, maintenance, and removal of storm water controls and with stabilization;
 - 6.3.2.** The location of all storm water controls on the site required by this permit and how they are to be maintained;
 - 6.3.3.** The proper procedures to follow with respect to the permit’s pollution prevention requirements; and
 - 6.3.4.** When and how to conduct inspections, record applicable findings, and take corrective actions.
- 6.4. EACH MEMBER OF THE STORM WATER TEAM MUST HAVE EASY ACCESS TO AN ELECTRONIC OR PAPER COPY** of applicable portions of this permit, the most updated copy of your SWPPP, and other relevant documents or information that must be kept with the SWPPP.

³² If the person requiring training is a new employee who starts after you commence construction activities, you must ensure that this person has the proper understanding as required above prior to assuming particular responsibilities related to compliance with this permit.

7. STORM WATER POLLUTION PREVENTION PLAN (SWPPP)

7.1. GENERAL REQUIREMENTS

All operators associated with a construction site under this permit must develop a SWPPP consistent with the requirements in Part 7 prior to their submittal of the NOI.³³ The SWPPP must be kept up-to-date throughout coverage under this permit.

If a SWPPP was prepared under a previous version of this permit, the operator must review and update the SWPPP to ensure that this permit's requirements are addressed prior to submitting an NOI for coverage under this permit.

7.2. SWPPP WRITER/REVIEWER CERTIFICATION REQUIREMENT Beginning January 1, 2021, a "qualified" SWPPP writer must write or certify SWPPPs for all projects disturbing greater than 5 acres, including small construction projects (1 to 5 acres) that have a perennial surface water within 50 feet of the project, or having a steep slope (70% or 35 degrees or more) with an elevation change from the slope of 10 feet or more (at any point during the time of construction – not including stock piles). A "qualified" SWPPP writer is knowledgeable in the principles and practices that must be considered in the development of a SWPPP. Acceptable qualifications include but are not limited to:

- a. Utah Registered SWPPP Writer (RSW)
- b. Licensed Professional Engineer (PE) in a related field or Professional Geologist (PG)
- c. Certified Professional in Erosion and Sediment Control (CPESC)
- d. Certified Professional in Storm Water Quality (CPSWQ)
- e. National Institute for Certification in Engineering Technologies, Erosion and Sediment Control, Level 3 (NICET)

7.3. SWPPP CONTENTS. At a minimum, the SWPPP must include the information specified in this Part and as specified in other parts of this permit.

7.3.1. Storm Water Team. Identify the personnel (by name or position) that are part of the storm water team, as well as their individual responsibilities, including which members are responsible for conducting inspections.

7.3.2. Nature of Construction Activities.³⁴ Include the following:

- a. A description of the nature of your construction activities, including the age or dates of past renovations for structures that are undergoing demolition;
- b. The size of the property (in acres or length in miles if a linear construction site);

³³ The SWPPP does not establish the effluent limits that apply to your site's discharges; these limits are established in this permit in Parts 2 and 3.

³⁴ If plans change due to unforeseen circumstances or for other reasons, the requirement to describe the sequence and estimated dates of construction activities is not meant to "lock in" the operator to meeting these dates. When departures from initial projections are necessary, this should be documented in the SWPPP itself, or in associated records, as appropriate.

- c. The total area expected to be disturbed by the construction activities including on-site and off-site construction support activity areas (to the nearest quarter acre or nearest quarter mile if a linear construction site);
- d. A description of any on-site and off-site construction support activity areas covered by this permit (see Part 1.2.2);
- e. A description and projected schedule for the following:
 - (1) Commencement of construction activities in each portion of the site, including clearing and grubbing, mass grading, demolition activities, site preparation (i.e., excavating, cutting and filling), final grading, and creation of soil and vegetation stockpiles requiring stabilization;
 - (2) Temporary or permanent cessation of construction activities in each portion of the site;
 - (3) Temporary or final stabilization of exposed areas for each portion of the site; and
 - (4) Removal of temporary storm water controls and construction equipment or vehicles, and the cessation of construction-related pollutant-generating activities.
- f. A list and description of all pollutant-generating activities³⁵ on the site. For each pollutant-generating activity, include an inventory of pollutants or pollutant constituents (e.g., sediment, fertilizers, pesticides, paints, caulks, sealants, fluorescent light ballasts, contaminated substrates, solvents, fuels) associated with that activity, which could be discharged in storm water from your construction site. You must take into account where potential spills and leaks could occur that contribute pollutants to storm water discharges, and any known hazardous or toxic substances, such as PCBs and asbestos, that will be disturbed or removed during construction;
- g. Business days and hours for the project;

7.3.3. Site Map. Include a legible map, or series of maps, showing the following features of the site:

- a. Boundaries of the property;
- b. Locations where construction activities will occur, including:
 - (1) Locations where earth-disturbing activities will occur (note any phasing), including any demolition activities;
 - (2) Approximate slopes before and after major grading activities (note any steep slopes (as defined in Part 10));
 - (3) Locations where sediment, soil, or other construction materials will be stockpiled;
 - (4) Any water of the state crossings;
 - (5) Designated points where vehicles will exit onto paved roads;
 - (6) Locations of structures and other impervious surfaces upon completion of construction; and
 - (7) Locations of on-site and off-site construction support activity areas covered by this permit (see Part 1.2.2).

³⁵ Examples of pollutant-generating activities include paving operations; concrete, paint, and stucco washout and waste disposal; solid waste storage and disposal; and dewatering operations

- c. Locations of all waters of the state within one mile downstream of the site's discharge point. Also identify if any are listed as impaired or high quality water;
- d. Type and extent of pre-construction cover on the site (e.g., vegetative cover, forest, pasture, pavement, structures);
- e. Drainage patterns of storm water and authorized non-storm water before and after major grading activities;
- f. Storm water and authorized non-storm water discharge locations, including:
 - (1) Locations where storm water and/or authorized non-storm water will be discharged to storm drain inlets;³⁶ and
 - (2) Locations where storm water or authorized non-storm water will be discharged directly to waters of the state.
- g. Locations of all potential pollutant-generating activities identified in Part 7.3.2.g;
- h. Locations of storm water controls, including natural buffer areas and any shared controls utilized to comply with this permit; and
- i. Locations where polymers, flocculants, or other treatment chemicals will be used and stored.

7.3.4. Non-Storm water Discharges. Identify all authorized non-storm water discharges in Part 1.2.3 that will or may occur.

7.3.5. Description of Storm water Controls.

- a. For each of the Part 2.2 erosion and sediment control effluent limits, Part 2.3 pollution prevention effluent limits as applicable to your site, you must include the following:
 - (1) A description of the specific control(s) to be implemented to meet the effluent limit;
 - (2) Any applicable storm water control design specifications (including references to any manufacturer specifications and/or erosion and sediment control manuals/ordinances relied upon);³⁷
 - (3) Routine storm water control maintenance specifications; and
 - (4) The projected schedule for storm water control installation/implementation.
- b. You must also include any of the following additional information as applicable.
 - (1) **Natural buffers** and/or equivalent sediment controls (see Part 2.2.1 and Part 10). You must include the following:
 - (i) The compliance alternative to be implemented;

³⁶ The requirement to show storm drain inlets in the immediate vicinity of the site on your site map only applies to those inlets that are easily identifiable from your site or from a publicly accessible area immediately adjacent to your site.

³⁷ Design specifications may be found in manufacturer specifications and/or in applicable erosion and sediment control manuals or ordinances. Any departures from such specifications must reflect good engineering practice and must be explained in the SWPPP.

- (ii) If complying with alternative 2, the width of natural buffer retained;
 - (iii) If complying with alternative 2 or 3, the erosion and sediment control(s) you will use to achieve an equivalent sediment reduction, and any information you relied upon to demonstrate the equivalency;
 - (iv) If complying with alternative 3, a description of why it is infeasible for you to provide and maintain an undisturbed natural buffer of any size;
 - (v) For “linear construction sites” where it is infeasible to implement compliance alternative 1, 2, or 3, a rationale for this determination, and a description of any buffer width retained and/or supplemental erosion and sediment controls installed; and
 - (vi) A description of any disturbances that are exempt under Part 2.2.1 that occur within 50 feet of a water of the state.
- (2) **Perimeter controls for a “linear construction site”** (see Part 2.2.3). For areas where perimeter controls are not feasible, include documentation to support this determination and a description of the other practices that will be implemented to minimize discharges of pollutants in storm water associated with construction activities.

Note: Routine maintenance specifications for perimeter controls documented in the SWPPP must include the Part 2.2.3.a requirement that sediment be removed before it has accumulated to one-half of the above-ground height of any perimeter control.

- (3) **Sediment track-out controls** (see Parts 2.2.4.b and 2.2.4.c). Document the specific stabilization techniques and/or controls that will be implemented to remove sediment prior to vehicle exit.
- (4) **Sediment basins** (see Part 2.2.12). In circumstances where it is infeasible to utilize outlet structures that withdraw water from the surface, include documentation to support this determination, including the specific conditions or time periods when this exception will apply.
- (5) **Treatment chemicals** (see Part 2.2.13), you must include the following:
- (i) A listing of the soil types that are expected to be exposed during construction in areas of the project that will drain to chemical treatment systems. Also include a listing of soil types expected to be found in fill material to be used in these same areas, to the extent you have this information prior to construction;
 - (ii) A listing of all treatment chemicals to be used at the site and why the selection of these chemicals is suited to the soil characteristics of your site;
 - (iii) If DWQ authorized you to use cationic treatment chemicals for sediment control, include the specific controls and implementation procedures designed to ensure that your use of cationic treatment chemicals will not lead to an exceedance of water quality standards, or harm to aquatic life;
 - (iv) The dosage of all treatment chemicals to be used at the site or the methodology to be used to determine dosage;

- (v) Information from any applicable Safety Data Sheet (SDS);
 - (vi) Schematic drawings of any chemically enhanced storm water controls or chemical treatment systems to be used for application of the treatment chemicals;
 - (vii) A description of how chemicals will be stored consistent with Part 2.2.13.c;
 - (viii) References to applicable local requirements affecting the use of treatment chemicals, and copies of applicable manufacturer's specifications regarding the use of your specific treatment chemicals and/or chemical treatment systems; and
 - (ix) A description of the training that personnel who handle and apply chemicals have received prior to permit coverage, or will receive prior to use of the treatment chemicals at your site.
- (6) **Stabilization measures** (see Part 2.2.14). You must include the following:
- (i) The specific vegetative and/or non-vegetative practices that will be used;
 - (ii) The stabilization deadline that will be met in accordance with Part 2.2.14.a(1)-(2);
 - (iii) It is important to meet the deadlines during the wet times of the year (if the area has a wet time of the year). During the dry times of the year the significance of stabilization deadlines is less important.
- (7) **Spill prevention and response procedures** (see Part 1.3.5 and Part 2.3). You must include the following:
- (i) Procedures for expeditiously stopping, containing, and cleaning up spills, leaks, and other releases. Identify the name or position of the employee(s) responsible for detection and response of spills or leaks; and
 - (ii) Procedures for notification of appropriate facility personnel, emergency response agencies, and regulatory agencies where a leak, spill, or other release containing a hazardous substance or oil in an amount equal to or in excess of a reportable quantity consistent with Part 2.3.6 and established under either 40 CFR 110, 40 CFR 117, or 40 CFR 302, occurs during a 24-hour period. Contact information must be in locations that are readily accessible and available to all employees.
 - (iii) You may also reference the existence of Spill Prevention Control and Countermeasure (SPCC) plans developed for the construction activity under Part 311 of the CWA, or spill control programs otherwise required by an UPDES permit for the construction activity, provided that you keep a copy of that other plan on site or electronically available.³⁸
- (8) **Waste management procedures** (see Part 2.3.3). Describe the procedures you will follow for handling, storing and disposing of all wastes generated at your site consistent with state and local requirements, including clearing and demolition debris, removal of spoil (excess dirt) from the site, construction and domestic waste, hazardous or toxic waste, and sanitary waste.

³⁸ Even if you already have an SPCC or other spill prevention plan in existence, your plans will only be considered adequate if they meet all of the requirements of this Part, either as part of your existing plan or supplemented as part of the SWPPP

- (9) **Application of fertilizers** (see Part 2.3.5). Document any departures from the manufacturer specifications where appropriate.

7.3.6. Procedures for Inspection, Maintenance, and Corrective Action. Describe the procedures you will follow for maintaining your storm water controls, conducting site inspections, and, where necessary, taking corrective actions, in accordance with Part 2.1.4, Part 4, and Part 5 of this permit. Also include:

- a. Personnel responsible for conducting inspections;
- b. The inspection schedule you will follow, which is based on whether your site is subject to Part 4.2 or Part 4.3, or whether your site qualifies for any of the reduced inspection frequencies in Part 4.4;
- c. If you will be conducting inspections in accordance with the inspection schedule in Part 4.2.2, or Part 4.3, the location of the rain gauge or the address of the weather station you will be using to obtain rainfall data;
- d. If you will be reducing your inspection frequency in accordance with Part 4.4.3, the beginning and ending dates of frozen conditions on your site; and
- e. Any maintenance or inspection checklists or other forms that will be used.

7.3.7. Staff Training. Include documentation that the required personnel were, or will be, trained in accordance with Part 6.

7.3.8. Compliance with Other Requirements.

- a. **Utah Water Quality Act Underground Injection Control (UIC) Program Requirements for Certain Subsurface Storm Water Controls.** If you are using any of the following storm water controls at your site, as they are described below, you must document any contact you have had with DWQ for implementing the requirements for underground injection wells in the Safe Drinking Water Act and DEQ's implementing regulations at UAC R317-7. In addition there may be local requirements related to such structures. Such controls (below) would generally be considered Class V UIC wells and all Class V UIC wells must be reported to DWQ for an inventory:
 - b. Infiltration trenches (if storm water is directed to any bored, drilled, driven shaft or dug hole that is deeper than its widest surface dimension, or has a subsurface fluid distribution system);
 - c. Commercially manufactured pre-cast or pre-built proprietary subsurface detention vaults, chambers, or other devices designed to capture and infiltrate storm water flow; and
 - d. Drywells, seepage pits, or improved sinkholes (if storm water is directed to any bored, drilled, driven shaft or dug hole that is deeper than its widest surface dimension, or has a subsurface fluid distribution system).

7.3.9. SWPPP Certification. You must sign and date your SWPPP in accordance with 9.16(1)a.

7.3.10. Post-Authorization Additions to the SWPPP. Once you are authorized for coverage under this permit, you must include the following documents as part of your SWPPP:

- a. A copy of your NOI submitted to DWQ along with any correspondence exchanged between you and DWQ related to coverage under this permit;
- b. A copy of this permit (an electronic copy easily available to the storm water team is also acceptable).

7.4. ON-SITE AVAILABILITY OF YOUR SWPPP

7.4.1. You must keep a current copy of your SWPPP at the site or at an easily accessible location so that it can be made available at the time of an on-site inspection or upon request by DWQ, the EPA, or an MS4. The SWPPP can be stored electronically as long as personnel on-site can access it and make it available for inspector review.

7.5. SWPPP MODIFICATIONS.

7.5.1. You must modify your SWPPP, including the site map(s), within seven (7) days of any of the following conditions:

- a. Whenever you make changes to your construction plans, storm water controls, or other activities at your site that are no longer accurately reflected in your SWPPP. This includes changes made in response to corrective actions triggered under Part 5. You do not need to modify your SWPPP if the estimated dates in Part 7.3.2.f change during the course of construction;
- b. To reflect areas on your site map where operational control has been transferred (e.g., new general contractor or owner), note the change and the date of transfer since initiating permit coverage;
- c. If inspections or investigations by DWQ or its authorized representatives determine that SWPPP modifications are necessary for compliance with this permit;
- d. Where DWQ determines it is necessary to install and/or implement additional controls at your site in order to meet the requirements of this permit, the following must be included in your SWPPP:
 - (1) A copy of any correspondence describing such measures and requirements; and
 - (2) A description of the controls that will be used to meet such requirements.
- e. To reflect any revisions to applicable federal, state, tribal, or local requirements that affect the storm water controls implemented at the site; and
- f. If applicable, if a change in chemical treatment systems or chemically enhanced storm water control is made, including use of a different treatment chemical, different dosage rate, or different area of application.

7.5.2. You must maintain records showing the dates of all SWPPP modifications. The records must include the name of the person authorizing each change (see Part 7.5.1 above) and a brief summary of all changes.

7.5.3. All modifications made to the SWPPP consistent with Part 7.5 must be authorized by a person identified in 9.16.(1)b.

7.5.4. Upon determining that a modification to your SWPPP is required, you must notify any persons or subcontractors that may be impacted by the change to the SWPPP.

8. HOW TO TERMINATE COVERAGE. Until you terminate coverage under this permit, you must comply with all conditions and effluent limitations in the permit. To terminate permit coverage, you must submit to DWQ a complete and accurate Notice of Termination (NOT, the NOT can be done online in the same account that the NOI was taken out in), which certifies that you have met the requirements for terminating in Part 8.

8.1. MINIMUM INFORMATION REQUIRED IN NOT.

8.1.1. UPDES ID (i.e., permit tracking number) provided by DWQ when you received coverage under this permit;

8.1.2. Basis for submission of the NOT (see Part 8.2);

8.1.3. Operator contact information;

8.1.4. Name of site and address (or a description of location if no street address is available); and

8.1.5. NOT certification.

8.2. CONDITIONS FOR TERMINATING CGP COVERAGE. You must terminate CGP coverage only if one or more of the following conditions has occurred:

8.2.1. You have completed all construction activities at your site and, if applicable, construction support activities covered by this permit (see Part 1.2.2.c), and you have met the following requirements:

- a. You have met the requirements for final vegetative or non-vegetative stabilization in Part 2.2.14.b for any areas that (1) were disturbed during construction, (2) are not covered over by permanent structures, and (3) over which you had control during the construction activities.;
- b. You have removed and properly disposed of all construction materials, waste and waste handling devices, and have removed all equipment and vehicles that were used during construction, unless intended for long-term use following your termination of permit coverage;
- c. You have removed all storm water controls that were installed and maintained during construction, except those that are intended for long-term use following your termination of permit coverage or those that are biodegradable; and
- d. You have removed all potential pollutants and pollutant-generating activities associated with construction, unless needed for long-term use following your termination of permit coverage; or

8.2.2. You have transferred control of all areas of the site for which you are responsible under this permit to another operator, and that operator has submitted a new NOI and obtained coverage under this permit. This only applies if the new operator obtains a new NOI. Termination is not required if a transfer form has been signed by both the previous operator and the new one to move the existing coverage; or

8.2.3. Coverage under an individual or alternative general UPDES permit has been obtained.

8.2.4. Completed homes that are occupied by home owners where at least temporary sediment and erosion controls are in place are allowed to be terminated without final stabilization. If a home owner buys a newly completed house the permit can be terminated while the property is being transferred to the home owner. The home owner should not be involved in the permit process. If

a home owner builds his/her house, they must terminate when the house is approved for occupancy where temporary storm water controls are in place on the site.

8.3. HOW TO SUBMIT YOUR NOT.

8.3.1. It is preferred that the DWQ “on-line” NOI system be used to submit an electronic NOT.

Access to the DWQ online storm water database found at the DWQ webpage at <https://secure.utah.gov/stormwater>. You must logon to the account created when the NOI was submitted and find the “Terminate” (or NOT) button for the permit tracking number when you wish to terminate a coverage. In the case where the permittee does not have access to the account for which the NOI was submitted the permittee must either contact DWQ and request account access or fill out and submit to DWQ a paper copy of the NOT form, which can be downloaded from the same DWQ website.

8.4. DEADLINE FOR SUBMITTING THE NOT. You must submit your NOT within 30 calendar days after any one of the conditions in Part 8.2 occurs.

8.5. PARTIAL NOT REQUIREMENTS. A partial NOT must be filed if a portion of the permitted site is sold to a new owner prior to completion of construction. You must notify the new owner of the requirement to obtain a storm water permit unless the new owner is the home owner. Prior to releasing a residential lot to a home owner the site must be temporarily stabilized as required in 8.2.4. You must notify DWQ of the change in ownership and provide the name, address, and telephone number of the new owner.

8.6. EFFECTIVE DATE OF TERMINATION OF COVERAGE. Your authorization to discharge under this permit terminates at midnight of the calendar day that a complete NOT is submitted to DWQ.

9. STANDARD PERMIT CONDITIONS.

9.1. DUTY TO COMPLY.

- (1) The permittee must comply with all conditions of the UPDES permit. Any permit noncompliance is a violation of the Utah Water Quality Act, as amended and is grounds for enforcement action; permit termination, revocation and reissuance or modification; or denial of a permit renewal application.
- (2) Penalties for Violations of Permit Conditions. The Utah Water Quality Act, in 19-5-115, provides that any person who violates the Act, or any permit, rule, or order adopted under it is subject to a civil penalty not to exceed \$10,000 per day of such violation.
- (3) Willful Non-Compliance or Negligence. Any person who willfully or with gross negligence violates the Act, or any permit, rule or order adopted under it is subject to a fine of not more than \$25,000 per day of violation. Any person convicted under 19-5-115 a second time shall be punished by a fine not exceeding \$50,000 per day.
- (4) False Statements. The Act provides that any person who knowingly makes any false material statement, representation, or certification in any application, record, report, plan, or other document filed or required to be maintained under the Act, the rules, or this Permit, or who knowingly falsifies, tampers with, or renders inaccurate, any monitoring device or method required to be maintained under the Act shall upon conviction, be punished by a fine of not more than \$10,000 or by imprisonment for 6 months, or by both. Utah Code Ann. § 19-5-115(4).

9.2. DUTY TO REAPPLY. If the permittee wishes to continue an activity regulated by this permit after the expiration date of the permit, the permittee shall apply for and obtain a new permit as required in R317-8-3.1

9.3. NEED TO HALT OR REDUCE ACTIVITY NOT A DEFENSE. It shall not be a defense for a permittee in an enforcement action that it would have been necessary to halt or reduce the permitted activity in order to maintain compliance with the conditions of this permit. (Upon reduction, loss, or failure of the treatment facility, the permittee, to the extent necessary to maintain compliance with the permit, shall control production of all discharges until the facility is restored or an alternative method of treatment is provided.)

9.4. DUTY TO MITIGATE. The permittee shall take all reasonable steps to minimize or prevent any discharge or sludge use or disposal in violation of the UPDES permit which has a reasonable likelihood of adversely affecting human health or the environment.

9.5. DUTY TO PROVIDE INFORMATION. The permittee shall furnish to the Director, within a reasonable time, any information which the Director may request to determine whether cause exists for modifying, revoking and reissuing, or terminating the permit or to determine compliance with this permit. The permittee shall also furnish to the Director, upon request, copies of records required to be kept by the permit.

9.6. OTHER INFORMATION. When the permittee becomes aware that he or she failed to submit any relevant facts or submitted incorrect information in the Notice of Intent or in any other report to the Director, he or she shall promptly submit such facts or information.

9.7. OIL AND HAZARDOUS SUBSTANCE LIABILITY. Nothing in this Permit shall be construed to preclude the institution of any legal action or relieve the Permittee from any responsibilities, liabilities, or penalties to which the Permittee is or may be subject under the "Act".

9.8. PROPERTY RIGHTS. The issuance of this Permit does not convey any property rights of any sort, nor any exclusive privileges, nor does it authorize any injury to private property nor any invasion of personal rights, nor any infringement of Federal, State or local laws or regulations.

9.9. SEVERABILITY. The provisions of this Permit are severable, and if any provision of this Permit, or the application of any provision of this Permit to any circumstance, is held invalid, the application of such provision to other circumstances, and the remainder of this Permit shall not be affected thereby.

9.10. RECORDS RETENTION.

- (1) The Permittee shall retain copies of SWPPPs and all reports required by this Permit, and records of all data used to complete the Notice of Intent to be covered by this Permit, for a period of at least three years from the date that the site is finally stabilized. This period may be extended by request of the Director at any time.
- (2) After final stabilization of the construction site is complete, the SWPPP is no longer required to be maintained on site, but may be maintained by the Permittee(s) at its primary headquarters. However, you must continue to allow DWQ access to the SWPPP as described in paragraph B.10(1) (above).

9.11. ADDRESSES. All written correspondence under this permit shall be directed to the Division of Water Quality at the following address:

Department of Environmental Quality
Division of Water Quality
195 North 1950 West
PO Box 144870
Salt Lake City, Utah 84114-4870

9.12. STATE LAWS.

- (1) Nothing in this Permit shall be construed to preclude the institution of any legal action or relieve the Permittee from any responsibilities, liabilities, or penalties established pursuant to any applicable State law or regulation under authority preserved by Utah Code Ann. § 19-5-117.
- (2) No condition of this Permit shall release the Permittee from any responsibility or requirements under other environmental statutes or regulations.

9.13. PROPER OPERATION AND MAINTENANCE. The Permittee shall at all times properly operate and maintain all facilities and systems of treatment and control (and related appurtenances) which are installed or used by the Permittee to achieve compliance with the conditions of this Permit and with the requirements of SWPPPs. Proper operation and maintenance also includes adequate laboratory controls and appropriate quality assurance procedures. Proper operation and maintenance requires the operation of backup or auxiliary

facilities or similar systems, installed by a Permittee only when necessary to achieve compliance with the conditions of the Permit.

9.14. INSPECTION AND ENTRY. The Permittee shall allow, upon presentation of credentials, the Director or an authorized representative:

- (1) To enter upon the Permittee's premises where a regulated facility or activity is located or conducted, or where records must be kept under the conditions of this Permit;
- (2) Have access to and copy at reasonable times, any records that must be kept under the conditions of this Permit;
- (3) Inspect at reasonable times any facilities, equipment (including monitoring and control equipment), practices, or operations regulated or required under this Permit; and
- (4) Sample or monitor at reasonable times, for the purposes of assuring permit compliance or as otherwise authorized by law, any substances or parameters at any location.

9.15. REOPENER CLAUSE.

- (1) Reopener Due to Water Quality Impacts. If there is evidence indicating that the storm water discharges authorized by this Permit cause, have the reasonable potential to cause or contribute to, a violation of a water quality standard, the discharger may be required to obtain an individual permit or an alternative general permit in accordance with Part 1.4.4 of this Permit or the Permit may be modified to include different limitations and/or requirements.
- (2) Reopener Guidelines. Permit modification or revocation will be conducted according to UAC R317-8-5.6 and UAC R317-8-6.2.
- (3) Permit Actions. This Permit may be modified, revoked and reissued, or terminated for cause. The filing of a request by the Permittee for a Permit modification, revocation and reissuance, or termination, or a notification of planned changes or anticipated noncompliance does not stay any Permit condition.

9.16. SIGNATORY REQUIREMENTS.

- (1) All Notices of Intent, SWPPPs, reports, certifications or information submitted to the Director, or that this Permit requires to be maintained by the Permittee, shall be signed as follows:
 - a. All notice of intent (NOIs), notices of termination (NOTs), and SWPPPs shall be signed as follows:
 - i. For a corporation: by a responsible corporate officer. For the purpose of this section, a responsible corporate officer means: a president, secretary, treasurer, or vice-president of the corporation in charge of a principal business function, or any other person who performs similar policy or decision-making functions for the corporation; or the manager of one or more manufacturing, production or operating facilities employing more than 250 persons or having gross annual sales or expenditures exceeding \$25,000,000 (in second-quarter 1980 dollars) if authority to sign documents has been assigned or delegated to the manager in accordance with corporate procedures;

- ii. For a partnership of sole proprietorship: by a general partner or the proprietor, respectively; or
- iii. For a municipality, State, Federal, or other public agency: by either a principal executive officer or ranking elected official. For purposes of this section, a principal executive officer of a Federal agency includes (1) the chief executive officer of the agency, or (2) a senior executive officer having responsibility for the overall operations of a principal geographic unit of the agency (e.g. Regional Administrators of EPA).
- b. All reports required by the Permit and other information requested by the Director or by an authorized representative of the Director shall be signed by a person described above or by a duly authorized representative of that person. A person is a duly authorized representative only if:
 - i. The authorization is made in writing by a person described above and kept with the SWPPP; and
 - ii. The authorization specifies either an individual or a position having responsibility for overall operation of the regulated site, facility or activity, such as the position of manager, operator, superintendent, or position of equivalent responsibility or an individual or position having overall responsibility for environmental matters for the company. (A duly authorized representative may thus be either a named individual or any individual occupying a named position).
- c. Certification. Any person signing documents under this Part B.16 shall make the following certification:

I certify under penalty of law that this document and all attachments were prepared under my direction or supervision in accordance with a system designed to assure that qualified personnel properly gathered and evaluated the information submitted. Based on my inquiry of the person or persons who manage the system, or those persons directly responsible for gathering the information, the information submitted is, to the best of my knowledge and belief true, accurate, and complete. I am aware that there are significant penalties for submitting false information, including the possibility of fine and imprisonment for knowing violations

10. DEFINITIONS AND ACRONYMS

“Act” – is a reference to the Utah Water Quality Act, or Utah Code Annotated Title 19, Chapter 5.

“Agricultural Land” - cropland, grassland, rangeland, pasture, and other agricultural land, on which agricultural and forest-related products or livestock are produced and resource concerns may be addressed. Agricultural lands include cropped woodland, marshes, incidental areas included in the agricultural operation, and other types of agricultural land used for the production of livestock.

“Antidegradation Policy” or “Antidegradation Requirements” - the water quality standards regulation that requires maintenance of water quality:

Waters whose existing quality is better than the established standards for the designated uses will be maintained at high quality unless it is determined by the Board, after appropriate intergovernmental coordination and public participation in concert with the Utah continuing planning process, allowing lower water quality is necessary to accommodate important economic or social development in the area in which the waters are located. However, existing instream water uses shall be maintained and protected. No water quality degradation is allowable which would interfere with or become injurious to existing instream water uses.

In those cases where potential water quality impairment associated with a thermal discharge is involved, the antidegradation policy and implementing method shall be consistent with Section 316 of the Federal Clean Water Act.

Category 1 Waters: Waters which have been determined by the Board to be of exceptional recreational or ecological significance or have been determined to be a State or National resource requiring protection, shall be maintained at existing high quality through designation, by the Board after public hearing, as Category 1 Waters. New point source discharges of wastewater, treated or otherwise, are prohibited in such segments after the effective date of designation. Protection of such segments from pathogens in diffuse, underground sources is covered in R317-5 and R317-7 and the Regulations for Individual Wastewater Disposal Systems (R317-501 through R317-515). Other diffuse sources (nonpoint sources) of wastes shall be controlled to the extent feasible through implementation of best management practices or regulatory programs.

Discharges may be allowed where pollution will be temporary and limited after consideration of the factors in R317-2-3.5.b.4., and where best management practices will be employed to minimize pollution effects.

Waters of the state designated as Category 1 Waters are listed in UAC R317-2-12.1.

Category 2 Waters: Category 2 Waters are designated surface water segments which are treated as Category 1 Waters except that a point source discharge may be permitted provided that the discharge does not degrade existing water quality. Discharges may be allowed where pollution will be temporary and limited after consideration of the factors in UAC R317-2-3.5.b.4., and where best management practices will be employed to minimize

pollution effects. Waters of the state designated as Category 2 Waters are listed in UAC R317-2-12.2.

Category 3 Waters: For all other waters of the state, point source discharges are allowed and degradation may occur, pursuant to the conditions and review procedures outlined in in the paragraph below (Antidegradation Review).

Antidegradation Review (ADR): An antidegradation review will determine whether the proposed activity complies with the applicable antidegradation requirements for receiving waters that may be affected.

An antidegradation review (ADR) may consist of two parts or levels. A Level I review is conducted to insure that existing uses will be maintained and protected.

Both Level I and Level II reviews will be conducted on a parameter-by-parameter basis. A decision to move to a Level II review for one parameter does not require a Level II review for other parameters. Discussion of parameters of concern is those expected to be affected by the proposed activity.

Antidegradation reviews shall include opportunities for public participation, as described in UAC R317-2-3.5e.

“Arid Areas” – areas with an average annual rainfall of 0 to 10 inches.

“Bank” (e.g., stream bank or river bank) – the rising ground bordering the channel of a water of the State of Utah.

“Best Management Practices (BMPs) – schedules of activities, prohibitions of practices, maintenance procedures, and other physical, structural and/or managerial practices to prevent or reduce pollution of waters of the State. BMPs include treatment requirements, operating procedures, and practices to control storm water associated with construction activity, spillage or leaks, sludge or waste disposal, or drainage from raw material storage.

“Bluff” – a steep headland, promontory, riverbank, or cliff.

“Borrow Areas” – the areas where materials are dug for use as fill, either onsite or off-site.

“Category 1, 2, and/or 3 Waters” – see “Antidegradation Policy” or “Antidegradation Requirements”.

“Cationic Treatment Chemical” – polymers, flocculants, or other chemicals that contain an overall positive charge. Among other things, they are used to reduce turbidity in storm water discharges by chemically bonding to the overall negative charge of suspended silts and other soil materials and causing them to bind together and settle out. Common examples of cationic treatment chemicals are chitosan and cationic PAM.

“Commencement of Earth-Disturbing Activities” - the initial disturbance of soils (or ‘breaking ground’) associated with clearing, grading, or excavating activities or other construction-related activities (e.g., stockpiling of fill material).

“Commencement of Pollutant-Generating Activities” – at construction sites (for the purposes of this permit) occurs in any of the following circumstances:

- Clearing, grubbing, grading, and excavation has begun;

- Raw materials related to your construction activity, such as building materials or products, landscape materials, fertilizers, pesticides, herbicides, detergents, fuels, oils, or other chemicals have been placed at your site;
- Use of authorized non-storm water for washout activities, or dewatering activities, have begun; or
- Any other activity has begun that causes the generation of or the potential generation of pollutants.

“Common Plan of Development or Sale” –is a plan to subdivide a parcel of land into separate parts for separate sale. This can be for a residential, commercial, or industrial development. The plan originates as a single parcel that is separated into parts. This usually goes through an approval process by a local governmental unit, but in some cases, it may not require that process. The original plan is considered the “common plan of development or sale” whether phased or completed in steps.

Additional information related to Common Plan of Development for Permit Purposes:

For UPDES storm water permit purposes, a common plan must have been initiated after October, 1992. A common plan of development or sale remains so until each lot or section of the development has fulfilled its planned purposes (e.g. in a residential development as homes are completed, stabilized, and sold or occupied). As lots or separated sections of the development are completed, the lot or section is stabilized, and the plan purposes are fulfilled for that area, lot, or section, it is no longer part of the common plan of development or sale (e.g. if a home is sold in a development and the owner decides to add a garage somewhere on the lot, that garage project is not part of the common plan of development or sale. In this process a common plan of development or sale may become reduced in size and/or separated by completed areas which are no longer part of the common plan of development or sale, but all unfinished lots remain part of the same common plan of development or sale until they are completed, stabilized, and fulfilled according to the purposes of the plan.

“Construction Activities” – earth-disturbing activities, such as the clearing, grading, and excavation of land.

“Construction and Development Point Source Category” (C&D Rule) – as published in 40 CFR § 450 is the regulation requiring effluent limitations guidelines (ELG’s) and new source performance standards (NSPS) for controlling the discharge of pollutants from construction sites.

“Construction Site” – the land or water area where construction activities will occur and where storm water controls will be installed and maintained. The construction site includes construction support activities, which may be located at a different part of the property from where the primary construction activity will take place, or on a different piece of property altogether. The construction site is often a smaller subset of the lot or parcel within which the project is taking place.

- “Construction Support Activities” – a construction-related activity that specifically supports the construction activity and involves earth disturbance or pollutant-generating activities of its own. This can include activities associated with concrete or asphalt batch plants, equipment staging yards, materials storage areas, excavated material disposal areas, and borrow areas.
- “Construction Waste” – discarded material (such as packaging materials, scrap construction materials, masonry products, timber, steel, pipe, and electrical cuttings, plastics, and styrofoam).
- “Conveyance Channel” – a temporary or permanent waterway designed and installed to safely convey storm water flow within and out of a construction site.
- “Corrective Action” – for the purposes of the permit, any action taken to (1) repair, modify, or replace any storm water control used at the site; (2) clean up and dispose of spills, releases, or other deposits found on the site; and (3) remedy a permit violation.
- “CWA” – the Clean Water Act or the Federal Water Pollution Control Act, 33 U.S.C. section 1251 et seq.
- “Dewatering” – the act of draining rainwater and/or groundwater from building foundations, vaults, and trenches.
- “Director” – the director of the Division of Water Quality, otherwise known as the Executive Secretary of the Utah Water Quality Board.
- “Discharge” – discharge of storm water or “discharge of a pollutant.”
- “Discharge of a Pollutant” – the addition of any “pollutant” or combination of pollutants to “waters of the State” from any “point source,” or any addition of any pollutant or combination of pollutants to the waters of the State. This includes additions of pollutants into waters of the State from: surface runoff which is collected or channeled by man; discharges through pipes, sewers, or other conveyances, leading into privately owned treatment works. See 40 CFR 122.2.
- “Discharge Point” – for the purposes of this permit, the location where collected and concentrated storm water flows are discharged from the construction site.
- “Discharge-Related Activity” – activities that cause, contribute to, or result in storm water and allowable non-storm water point source discharges, and measures such as the siting, construction, and operation of storm water controls to control, reduce, or prevent pollutants from being discharged.
- “Discharge to an Impaired Water” – for the purposes of this permit, a discharge to an impaired water occurs if the first water of the State to which you discharge is identified by DWQ or EPA pursuant to Section 303(d) of the Clean Water Act as not meeting an applicable water quality standard, or is included in an EPA-approved or DWQ established total maximum daily load (TMDL). For discharges that enter a storm sewer system prior to discharge, the water of the State to which you discharge is the first water of the State that receives the storm water discharge from the storm sewer system.
- “Domestic Waste” – for the purposes of this permit, typical household trash, garbage or rubbish items generated by construction activities.

- “Drought-Stricken Area” – for the purposes of this permit, an area in which the National Oceanic and Atmospheric Administration’s U.S. Seasonal Drought Outlook indicates for the period during which the construction will occur that any of the following conditions are likely: (1) “Drought to persist or intensify”, (2) “Drought ongoing, some improvement”, (3) “Drought likely to improve, impacts ease”, or (4) “Drought development likely”. See http://www.cpc.ncep.noaa.gov/products/expert_assessment/sdo_summary.php
- “Earth-Disturbing Activity” or “Land-Disturbing Activity” – actions taken to alter the existing vegetation and/or underlying soil of a site, such as clearing, grading, site preparation (e.g., excavating, cutting, and filling), soil compaction, and movement and stockpiling of top soils.
- “Effective Operating Condition” – for the purposes of this permit, a storm water control is kept in effective operating condition if it has been implemented and maintained in such a manner that it is working as designed to minimize pollutant discharges.
- “Effluent Limitations” – for the purposes of this permit, any of the Part 2 or Part 3 requirements.
- “Electronic Notice of Intent” – DWQ’s online system for submitting electronic Construction General Permit forms. Can be accessed at <https://secure.utah.gov/stormwater>.
- “Emergency-Related Project” – a project initiated in response to a public emergency (e.g., natural disaster, disruption in essential public services), for which the related work requires immediate authorization to avoid imminent endangerment to human health or the environment, or to reestablish essential public services.
- “Excursion” – a violation of a standard or limit.
- “Existing Project” – a construction project that commenced construction activities prior to the issuance date of this permit.
- “Existing Permit Coverage” – means that the permittee had permit coverage under a previous permit prior to the issuance of this permit.
- “Exit Points” – any points of egress from the construction site to be used by vehicles and equipment during construction activities.
- “Exposed Soils” – for the purposes of this permit, soils that as a result of earth-disturbing activities are disturbed and exposed to the elements of weather.
- “Final Stabilization” – All disturbed areas must be covered by permanent structures such as pavement, concrete slab, building, etc., or for areas not covered by permanent structures but that are receiving 20 inches or more of average annual precipitation, vegetation has been established with a uniform (e.g., evenly distributed, without large bare areas) perennial vegetative cover equivalent to 70 percent of the natural background vegetative cover. In the case of areas that are not covered by permanent structures, but that are receiving less than 20 inches of average annual precipitation (arid areas, 0-10 inches; semi-arid areas, 10-20 inches), final stabilization is equivalent to the requirements of 2.2.2.b of this permit, including the provisions for permanent stabilization.

“Groundwater” – water in the voids and interstitial spaces around soil particles beneath the surface of the ground, even if it is only temporary.

“Hazardous Materials” or “Hazardous Substances” or “Hazardous or Toxic Waste” – for the purposes of this permit, any liquid, solid, or contained gas that contain properties that are dangerous or potentially harmful to human health or the environment. See also 40 CFR §261.2.

“Impaired Water” or “Water Quality Impaired Water” or “Water Quality Limited Segment” – for the purposes of this permit, waters identified as impaired on the CWA Section 303(d) list, or waters with an EPA-approved or established TMDL. Your construction site will be considered to discharge to an impaired water if the first water of the state to which you discharge is identified by DWQ pursuant to Section 303(d) of the CWA as not meeting an applicable water quality standard, or is included in an EPA-approved or DWQ established total maximum daily load (TMDL). For discharges that enter a storm sewer system prior to discharge, the first water of the state to which you discharge is the water body that receives the storm water discharge from the storm sewer system.

“Impervious Surface” – for the purpose of this permit, any land surface with a low or no capacity for soil infiltration including, but not limited to, pavement, sidewalks, parking areas and driveways, packed gravel or soil, or rooftops.

“Indian Country” or “Indian Country Lands” – defined at 40 CFR §122.2 as:

1. All land within the limits of any Indian reservation under the jurisdiction of the United States Government, notwithstanding the issuance of any patent, and, including rights-of-way running through the reservation;
2. All dependent Indian communities within the borders of the United States whether within the originally or subsequently acquired territory thereof; and
3. All Indian allotments, the Indian titles to which have not been extinguished, including rights-of-ways running through the same.

“Infeasible” – for the purpose of this permit, infeasible means not technologically possible or not economically practicable and achievable in light of best industry practices. DWQ notes that it does not intend for any permit requirement to conflict with state water rights law.

“Install” or “Installation” – when used in connection with storm water controls, to connect or set in position storm water controls to make them operational.

“Intermittent (or Seasonal) Stream” – one which flows at certain times of the year when ground water provides water for stream flow, or during and immediately after some precipitation events or snowmelt.

“Landward” – positioned or located away from a water body, and towards the land.

“Level Spreader” – a temporary storm water control used to spread storm water flow uniformly over the ground surface as sheet flow to prevent concentrated, erosive flows from occurring.

“Linear Construction Project” – includes the construction of roads, bridges, conduits, substructures, pipelines, sewer lines, towers, poles, cables, wires, connectors, switching, regulating and transforming equipment and associated ancillary facilities in a long, narrow area.

“Minimize” – to reduce and/or eliminate to the extent achievable using storm water controls that are technologically available and economically practicable and achievable in light of best industry practices.

“Municipal Separate Storm Sewer System” or “MS4” – defined at 40 CFR §122.26(b)(8) as a conveyance or system of conveyances (including roads with drainage systems, municipal streets, catch basins, curbs, gutters, ditches, manmade channels, or storm drains):

1. Owned and operated by a state, city, town, county, district, association, or other public body (created by or pursuant to State law) having jurisdiction over disposal of sewage, industrial wastes, storm water, or other wastes, including special districts under State law such as a sewer district, flood control district or drainage district, or similar entity, or a designated and approved management agency under section 208 of the CWA that discharges to waters of the State;
2. Designed or used for collecting or conveying storm water;
3. Which is not a combined sewer; and
4. Which is not part of a Publicly Owned Treatment Works (POTW) as defined at 40 CFR §122.2.

“Native Topsoil” – the uppermost layer of naturally occurring soil for a particular area, and is often rich in organic matter, biological activity, and nutrients.

“Native Vegetation” – the species of plants that have developed for a particular region or ecosystem and are considered endemic to that area.

“Natural Buffer” – for the purposes of this permit, an area of undisturbed natural cover surrounding surface waters within which construction activities are restricted. Natural cover includes the vegetation, exposed rock, or barren ground that exists prior to commencement of earth-disturbing activities.

“Natural Vegetation” – vegetation that occurs spontaneously without regular management, maintenance or species introductions, removals, and that generally has a strong component of native species.

“New Operator of a New or Existing Project” – an operator that through transfer and/or operation replaces the operator of an already permitted construction project.

“New Project” – a construction project that commenced construction activities on or the issuance date of this permit.

“New Source” – for the purpose of this permit, a construction project that commenced construction activities on or after the issuance date of this permit.

“New Source Performance Standards (NSPS)” – for the purposes of this permit, NSPS are technology-based standards that apply to construction sites that are new sources under 40 CFR 450.24.

“Non-Storm Water Discharges” – discharges that do not originate from storm events. They can include, but are not limited to, discharges of process water, air conditioner condensate, noncontact

cooling water, vehicle wash water, sanitary wastes, concrete washout water, paint wash water, irrigation water, or pipe testing water.

“Non-Turbid” – is a term used in this permit to describe water that appears visually clear and there appears to be no evidence of silt or sediment present in the water.

“Notice of Intent” (NOI) – the form (electronic or paper) required for authorization of coverage under the Construction General Permit.

“Notice of Termination” (NOT) – the form (electronic or paper) required for terminating coverage under the Construction General Permit.

“Operational” – for the purpose of this permit, storm water controls are made “operational” when they have been installed and implemented, are functioning as designed, and are properly maintained.

“Operator” – for the purposes of this permit and in the context of storm water discharges associated with construction activity, any party associated with a construction project that meets either of the following two criteria:

1. The party which has operational control over construction plans and specifications, including the ability to make modifications to those plans and specifications (e.g. in most cases this is the owner of the site, sometimes it is a lessor); or
2. The party which has day-to-day operational control of those activities at a project that are necessary to ensure compliance with the permit conditions (e.g., they are authorized to direct workers at a site to carry out activities required by the permit; in most cases this is the general contractor of the project).

“Ordinary High Water Mark” – the line on the shore established by fluctuations of water and indicated by physical characteristics such as a clear, natural line impressed on the bank, shelving, changes in the character of soil, destruction of terrestrial vegetation, and/or the presence of litter and debris.

“Outfall” – see “Discharge Point.”

“Owner” – for the purpose of this permit an owner has legal ownership of property on which construction activity is taking place. Except in the case of leased property, an owner is the party that has ultimate control over the destiny of a project. This is the lessor in the case of leased property.

“Permittee” – is the owner and/or operator named in the NOI for the project.

“Point(s) of Discharge” – see “Discharge Point.”

“Point Source” – any discernible, confined, and discrete conveyance, including but not limited to, any pipe, ditch, channel, tunnel, conduit, well, discrete fissure, container, rolling stock concentrated animal feeding operation, landfill leachate collection system, or vessel or other floating craft from which pollutants are or may be discharged. This term does not include return flows from irrigated agriculture or agricultural storm water runoff.

“Pollutant” – defined at 40 CFR §122.2. A partial listing from this definition includes: dredged spoil, solid waste, sewage, garbage, sewage sludge, chemical wastes, biological materials, heat, wrecked or discarded equipment, rock, sand, cellar dirt, and industrial or municipal waste.

“Pollutant-Generating Activities” – at construction sites (for the purposes of this permit), those activities that lead to or could lead to the generation of pollutants, either as a result of earth disturbance or a related support activity. Some of the types of pollutants that are typically found at construction sites are:

- sediment;
- nutrients;
- heavy metals;
- pesticides and herbicides;
- oil and grease;
- bacteria and viruses;
- trash, debris, and solids;
- treatment polymers; and
- any other toxic chemicals.

“Pollution Prevention Measures” – storm water controls designed to reduce or eliminate the addition of pollutants to construction site discharges through analysis of pollutant sources, implementation of proper handling/disposal practices, employee education, and other actions.

“Polymers” – for the purposes of this permit, coagulants and flocculants used to control erosion on soil or to enhance the sediment removal capabilities of sediment traps or basins. Common construction site polymers include polyacrylamide (PAM), chitosan, alum, polyaluminum chloride, and gypsum.

“Prohibited Discharges” – discharges that are not allowed under this permit, including:

1. Wastewater from washout of concrete;
2. Wastewater from washout and cleanout of stucco, paint, form release oils, curing compounds and other construction materials;
3. Fuels, oils, or other pollutants used in vehicle and equipment operation and maintenance;
4. Soaps or solvents used in vehicle and equipment washing;
5. Toxic or hazardous substances from a spill or other release; and
6. Waste, garbage, floatable debris, construction debris, and sanitary waste from pollutant generating activities.

“Provisionally Covered Under this Permit” – for the purposes of this permit, DWQ provides temporary coverage under this permit for emergency-related projects prior to receipt of a complete and

accurate NOI. Discharges from earth-disturbing activities associated with the emergency-related projects are subject to the terms and conditions of the permit during the period of temporary coverage.

“Receiving Water” – a “Water of the State into which the regulated storm water discharges. If the discharge is to a storm sewer system, the receiving water is the waterbody to which the storm system discharges.

“Regulatory Authority” – as it pertains to this permit means EPA, DWQ, or a local MS4 that oversees construction activity.

“Run-On” – sources of storm water that drain from land located upslope or upstream from the regulated site in question.

“Semi-Arid Areas” – areas with an average annual rainfall of over 10 to 20 inches.

“Site” – for construction activities, the land or water area where earth-disturbing activities take place, including construction support activities.

“Small Construction Activity” – defined at Utah Administrative Code R317-8-3.9(6)(e)1. and incorporated here by reference. A small construction activity includes clearing, grading, and excavating resulting in a land disturbance that will disturb equal to or greater than one (1) acre and less than five (5) acres of land or will disturb less than one (1) acre of total land area but is part of a larger common plan of development or sale that will ultimately disturb equal to or greater than one (1) acre and less than five (5) acres. Small construction activity does not include routine maintenance that is performed to maintain the original line and grade, hydraulic capacity, or original purpose of the site.

“Small Residential Lot” – for the purpose of this permit, a lot being developed for residential purposes that will disturb less than 1 acre of land, but is part of a larger residential project that will ultimately disturb greater than or equal to 1 acre.

“Snowmelt” – the conversion of snow into overland storm water and groundwater flow as a result of warmer temperatures.

“Spill” – for the purpose of this permit, the release of a hazardous or toxic substance from its container or containment.

“Stabilization” – the use of vegetative and/or non-vegetative cover to prevent erosion and sediment loss in areas of disturbed soil exposed from the construction process.

“Steep Slopes” –for this permit steep slopes are defined as those that are 70 percent or greater in grade.

“Storm Event” – a precipitation event that results in a measurable amount of precipitation.

“Storm Sewer” – a system of pipes (separate from sanitary sewers) that carries storm water runoff from buildings and land surfaces.

“Storm Sewer System” – a conveyance or system of conveyances (including roads with drainage systems, municipal streets, catch basins, curbs, gutters, ditches, manmade channels, or storm drains) designed or used for collecting or conveying storm water.

“Storm Water” – storm water runoff from precipitation, snow melt runoff, and surface runoff and drainage.

“Storm Water Control Measure” - refers to any storm water control, BMP, or other method (including narrative effluent limitations) used to prevent or reduce the discharge of pollutants to waters of the state.

“Storm Water Controls” – see “Storm Water Control measure.”

“Storm Water Discharge Associated with Construction Activity” – as used in this permit, a discharge of pollutants in storm water to waters of the state from areas where land disturbing activities (e.g., clearing, grading, or excavation) occur, or where construction materials or equipment storage or maintenance (e.g., fill piles, borrow area, concrete truck chute wash down, fueling), or other industrial storm water directly related to the construction process (e.g., concrete or asphalt batch plants), are located.

“Storm Water Inlet” or “Storm Drain Inlet” – an entrance or opening to a storm water conveyance system, generally placed below grade so as to receive storm water drainage from the surrounding area.

“Storm Water Team” – the group of individuals responsible for oversight of the development and modifications of the SWPPP, and oversight of compliance with the permit requirements. The individuals on the “Storm water Team” must be identified in the SWPPP.

“Subcontractor” – for the purposes of this permit, an individual or company that takes a portion of a contract from the general contractor or from another subcontractor.

“Surface Water” – for this permit a surface water is defined all open water bodies, streams, lakes, ponds, marshes, wetlands, watercourses, waterways, springs, drainage systems, and all other bodies or accumulations of water on the surface only. Surface water is visible water, standing or flowing, above the surface of the ground.

“SWPPP” (Storm Water Pollution Prevention Plan) – a site-specific, written document that, among other things: (1) identifies potential sources of storm water pollution at the construction site; (2) describes storm water control measures to reduce or eliminate pollutants in storm water discharges from the construction site; and (3) identifies procedures the operator will implement to comply with the terms and conditions of this general permit.

“Temporary Stabilization” – a condition where exposed soils or disturbed areas are provided a temporary vegetative and/or non-vegetative protective cover to prevent erosion and sediment loss. Temporary stabilization may include temporary seeding, geotextiles, mulches, and other techniques to reduce or eliminate erosion until either final stabilization can be achieved or until further construction activities take place to re-disturb this area.

“Thawing Conditions” – for the purposes of this permit, thawing conditions are expected based on the historical likelihood of two or more days with daytime temperatures greater than 32°F. This date can be determined by looking at historical weather data. The estimation of thawing conditions is for planning purposes only. During construction the permittee will be required to conduct site inspections based upon actual conditions (i.e., if thawing conditions occur

sooner than expected, the permittee will be required to conduct inspections at the regular frequency).

“Total Maximum Daily Load” or “TMDL” – the sum of the individual wasteload allocations (WLAs) for point sources and load allocations (LAs) for nonpoint sources and natural background. If a receiving water has only one point source discharger, the TMDL is the sum of that point source WLA plus the LAs for any nonpoint sources of pollution and natural background sources, tributaries, or adjacent segments. TMDLs can be expressed in terms of either mass per time, toxicity, or other appropriate measure.

“Toxic Waste” – see “Hazardous Materials.”

“Turbidity” – when the term is used in a narrative it means a condition of water quality characterized by the presence of cloudiness usually caused by suspended solids and/or organic material. It refers to the visual clarity in water and is measured in a test passing light through a sample of water and quantifying the amount of light passing. The measurement is not directly proportional to the quantity of sediment in the water sample it is directly related to the quantity of light that passes through the sample. Particulate size and other factors can affect the amount of light that passes through the sample. This measurement is called nephelometric turbidity units or ntu.

“Uncontaminated Discharge” – a discharge that does not cause or contribute to an exceedance of applicable water quality standards.

“Upland” - the dry land area above and ‘landward’ of the ordinary high water mark.

“Utah Pollutant Discharge Elimination System (UPDES)” – The State of Utah’s program for issuing, modifying, revoking and reissuing, terminating, monitoring, and enforcing permits, and imposing and enforcing pretreatment requirements, under sections 307, 102, 318, and 405 of the Clean water Act (CWA) for the “discharge” of “pollutants” to “Waters of the State”. This program is specifically designed to be compatible with the federal National Pollutant Discharge Elimination System (NPDES) program established and administered by the EPA.

“Water-Dependent Structures” – structures or facilities that are required to be located directly adjacent to a waterbody or wetland, such as a marina, pier, boat ramp, etc.

“Water Quality Standards” –are provisions of State law which consist of a designated use or uses for the waters of the United States, water quality criteria for such waters based upon such uses, and an antidegradation policy to protect high quality waters. Water quality standards protect the public health or welfare, enhance the quality of water and serve the purposes of the Utah Water Quality Act.

“Waters of the State” – means all streams, lakes, ponds, marshes, water-courses, waterways, wells, springs, irrigation systems, drainage systems, and all other bodies or accumulations of water, surface and underground, natural or artificial, public or private, which are contained within, flow through, or border upon this state or any portion thereof, except that bodies of water confined to and retained within the limits of private property, and which do not develop into or constitute a nuisance, or a public health hazard, or a menace to fish and

wildlife, shall not be considered to be "waters of the state" under this definition (Section 19-5-102).

“Wetland” – those areas that are inundated or saturated by surface or groundwater at a frequency and duration sufficient to support, and that under normal circumstances do support, a prevalence of vegetation typically adapted for life in saturated soil conditions. Wetlands generally include swamps, marshes, bogs, and similar areas. On-site evaluations are typically required to confirm the presence and boundaries of wetlands.

“Work day” – for the purposes of this permit, a work day is a calendar day on which construction activities will take place.

Acronyms

C&D – Construction & Development

CGP – Construction General Permit

CFR – Code of Federal Regulations

CPoD – Common Plan of Development or Sale

CWA – Clean Water Act

DEQ – Department of Environmental Quality

DDW – Division of Drinking Water

DWQ – Division of Water Quality

EPA – United States Environmental Protection Agency

MS4 – Municipal Separate Storm Sewer System

NMFS – United States National Marine Fisheries Service

NOI – Notice of Intent

NOT – Notice of Termination

NPDES – National Pollutant Discharge Elimination System

NRC – National Response Center

NRCS – National Resources Conservation Service

POTW – Publicly Owned Treatment Works

SPCC – Spill Prevention Control and Countermeasure

SW – Storm Water

SWMP – Storm Water Management Plan

SWPPP – Storm Water Pollution Prevention Plan

TMDL – Total Maximum Daily Load

UAC – Utah Administrative Code

UCA – Utah Code Annotated

UPDES – Utah Pollution Discharge Elimination System

UWQA – Utah Water Quality Act

WQS – Water Quality Standard

Appendix A

Buffer Requirements

The purpose of this appendix is to assist you in complying with the requirements in Part 2.2.1 of the permit regarding the establishment of natural buffers and/or equivalent sediment controls. This appendix is organized as follows:

A.1. SITES THAT ARE REQUIRED TO PROVIDE AND MAINTAIN NATURAL BUFFERS AND/OR EQUIVALENT EROSION AND SEDIMENT CONTROLS.....	A-2
A.2. COMPLIANCE ALTERNATIVES AND EXCEPTIONS.....	A-2
A.2.1. Compliance Alternatives.....	A-2
A.2.2. Exceptions to Compliance Alternatives.....	A-3
A.2.3. Requirements for Providing and Maintaining Natural Buffers.....	A-4
A.2.4. Guidance for Providing the Equivalent Sediment Reduction as a 50-foot Buffer.....	A-7
A.3. SMALL RESIDENTIAL LOT COMPLIANCE ALTERNATIVES.....	A-11
A.3.1. Small Residential Lot Compliance Alternative Eligibility.....	A-11
A.3.2. Small Residential Lot Compliance Alternatives.....	A-12
Attachment 1 –Sediment Removal Efficiency Tables.....	A-16
Attachment 2 – Using the Sediment Removal Efficiency Tables – Questions and Answers.....	A-18
Attachment 3 – Example of How to Use the Sediment Removal Efficiency Tables.....	A-19

A.1 SITES THAT ARE REQUIRED TO PROVIDE AND MAINTAIN NATURAL BUFFERS AND/OR EQUIVALENT EROSION AND SEDIMENT CONTROLS

The requirement in Part 2.2.1 to provide and maintain natural buffers and/or equivalent erosion and sediment controls applies for any discharges to waters of the state located within 50 feet of your site's earth disturbances. If the water of the state is not located within 50 feet of earth-disturbing activities, Part 2.2.1 does not apply. See Figure A-1.

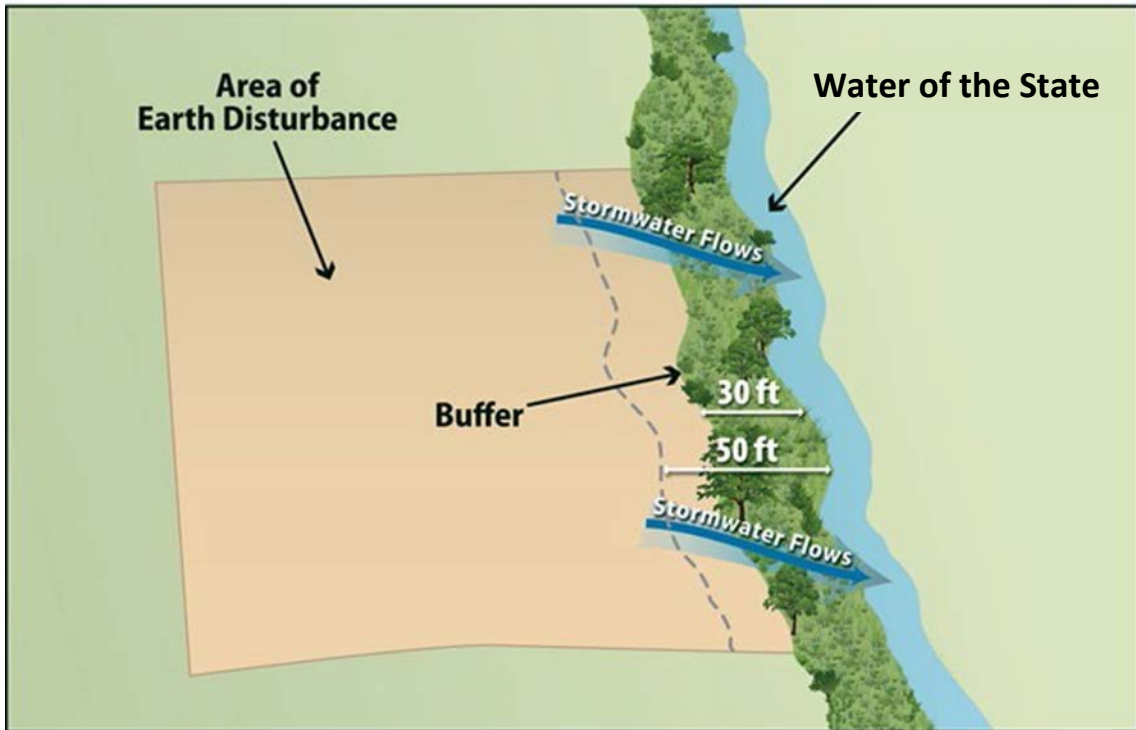

Figure A-1 Example of earth-disturbing activities within 50 feet of a water of the state.

A.2 COMPLIANCE ALTERNATIVES AND EXCEPTIONS

A.2.1. Compliance Alternatives

If Part 2.2.1 applies to your site, you have three compliance alternatives from which you can choose, unless you qualify for any of the exceptions (see below and Part 2.2.1.a):

1. Provide and maintain a 50-foot undisturbed natural buffer; or
2. Provide and maintain an undisturbed natural buffer that is less than 50 feet and is supplemented by erosion and sediment controls that achieve the sediment load reduction equivalent to a 50-foot undisturbed natural buffer; or
3. If infeasible to provide and maintain an undisturbed natural buffer of any size, implement erosion and sediment controls to achieve the sediment load reduction equivalent to a 50-foot undisturbed natural buffer.

The compliance alternative selected must be maintained throughout the duration of permit coverage.

See Part A.2.2 below for exceptions to the compliance alternatives.

See Part A.2.3 for requirements applicable to providing and maintaining natural buffers under compliance alternatives 1 and 2 above.

See Part A.2.4 for requirements applicable to providing erosion and sediment controls that achieve the sediment load reduction equivalent to a 50-foot undisturbed natural buffer under compliance alternatives 2 and 3 above.

A.2.2. Exceptions to the Compliance Alternatives

The following exceptions apply to the requirement to implement one of the Part 2.2.1.a compliance alternatives (see also Part 2.2.1.b):

- The following disturbances within 50 feet of a water of the state are exempt from the requirements Part 2.2.1 and this Appendix:
 - Construction approved under a CWA Section 404 permit; or
 - Construction of a water-dependent structure or water access areas (e.g., pier, boat ramp, trail).
- If there is no discharge of storm water to waters of the state through the area between the disturbed portions of the site and any waters of the state located within 50 feet of your site, you are not required to comply with the requirements in Part 2.2.1 and this Appendix. This includes situations where you have implemented controls measures, such as a berm or other barrier that will prevent such discharges.
- Where no natural buffer exists due to preexisting development disturbances (e.g., structures, impervious surfaces) that occurred prior to the initiation of planning for the current development of the site, you are not required to comply with the requirements in Part 2.2.1 and this Appendix.

Where some natural buffer exists but portions of the area within 50 feet of the water of the state are occupied by preexisting development disturbances, you are required to comply with the requirements in Part 2.2.1 and this Appendix. For the purposes of calculating the sediment load reduction for either compliance alternative 2 or 3, you are not expected to compensate for the reduction in buffer function that would have resulted from the area covered by these preexisting disturbances. Clarity about how to implement the compliance alternatives for these situations is provided in A.2.3 and A.2.4 below.

If during your project, you will disturb any portion of these preexisting disturbances, the area removed will be deducted from the area treated as a “natural buffer.”

- For “linear construction sites” (see Definitions), you are not required to comply with this requirement if site constraints (e.g., limited right-of-way) make it infeasible to implement one of the Part 2.2.1.a compliance alternatives, provided that, to the extent feasible, you limit disturbances within 50 feet of any waters of the state and/or you provide supplemental erosion and sediment controls to treat storm water discharges from earth

disturbances within 50 feet of the water of the state. You must also document in your SWPPP your rationale for why it is infeasible for you to implement one of the Part 2.2.1.a compliance alternatives, and describe any buffer width retained and supplemental erosion and sediment controls installed.

- For “small residential lot” construction (i.e., a lot being developed for residential purposes that will disturb less than 1 acre of land, but is part of a larger residential project that will ultimately disturb greater than or equal to 1 acre), you have the option of complying with one of the “small residential lot” compliance alternatives in Part A.3 of this appendix.

Note that you must document in your SWPPP if any disturbances related to any of the above exceptions occurs within the buffer area on your site.

A.2.3. Requirements for Providing and Maintaining Natural Buffers

This part applies to you if you choose compliance alternative 1 (50-foot buffer), compliance alternative 2 (a buffer of < 50 feet supplemented by additional erosion and sediment controls that achieve the equivalent sediment load reduction as the 50-foot buffer), or if you are providing a buffer in compliance with one of the “small residential lot” compliance alternatives in Part A.3.

Buffer Width Measurement

Where you are retaining a buffer of any size, the buffer should be measured perpendicularly from any of the following points, whichever is further landward from the water:

4. The ordinary high water mark of the water body, defined as the line on the shore established by fluctuations of water and indicated by physical characteristics such as a clear, natural line impressed on the bank, shelving, changes in the character of soil, destruction of terrestrial vegetation, and/or the presence of litter and debris; or
5. The edge of the stream or river bank, bluff, or cliff, whichever is applicable.

Refer to Figure A-2 and Figure A-3. You may find that specifically measuring these points is challenging if the flow path of the water of the state changes frequently, thereby causing the measurement line for the buffer to fluctuate continuously along the path of the waterbody. Where this is the case, DWQ suggests that rather than measuring each change or deviation along the water’s edge, it may be easier to select regular intervals from which to conduct your measurement. For instance, you may elect to conduct your buffer measurement every 5 to 10 feet along the length of the water.

Additionally, note that if earth-disturbing activities will take place on both sides of a water of the state that flows through your site, to the extent that you are establishing a buffer around this water, it must be established on both sides. For example, if you choose compliance alternative 1, and your project calls for disturbances on both sides of a small stream, you would need to retain the full 50 feet of buffer on both sides of the water. However, if your construction activities will only occur on one side of the stream, you would only need to retain the 50-foot buffer on the side of the stream where the earth- disturbance will occur.

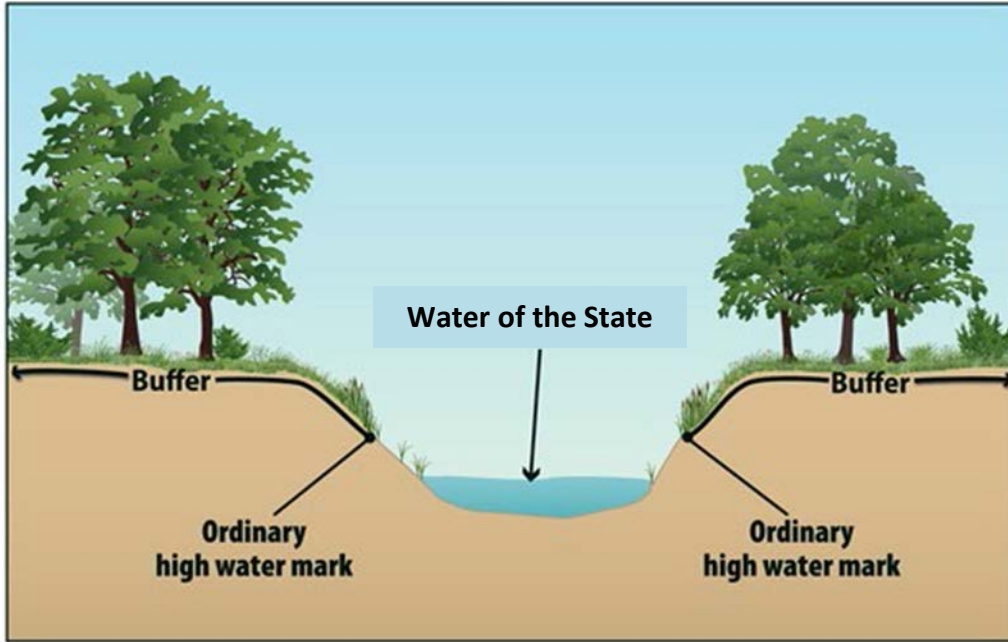

Figure A-2 Buffer measurement from the ordinary high water mark of the water body, as indicated by a clear natural line impressed on the bank, shelving, changes in the character of the soil, destruction of terrestrial vegetation, and/or the presence of litter/debris.

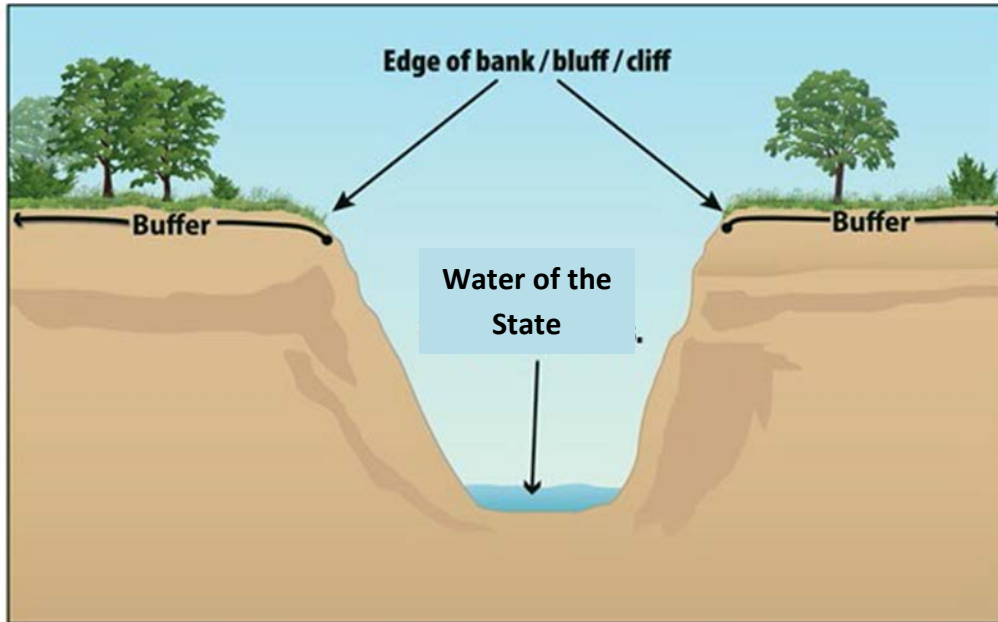

Figure A-3 Buffer measurement from the edge of the bank, bluff, or cliff, whichever is applicable.

Limits to Disturbance Within the Buffer

You are considered to be in compliance with the requirement to provide and maintain a natural buffer if you retain and protect from construction activities the natural buffer that existed prior to the commencement of construction. If the buffer area contains no vegetation prior to the

commencement of construction (e.g., sand or rocky surface), you are not required to plant vegetation. As noted above, any preexisting structures or impervious surfaces may occur in the natural buffer provided you retain and protect from disturbance the buffer areas outside of the preexisting disturbance.

To ensure that the water quality protection benefits of the buffer are retained during construction, you are prohibited from conducting any earth-disturbing activities within the buffer during permit coverage. In furtherance of this requirement, **prior to commencing earth-disturbing activities on your site, you must delineate, and clearly mark off, with flags, tape, or a similar marking device, the buffer area on your site.** The purpose of this requirement is to make the buffer area clearly visible to the people working on your site so that unintended disturbances are avoided.

While you are not required to enhance the quality of the vegetation that already exists within the buffer, you are encouraged to do so where such improvements will enhance the water quality protection benefits of the buffer. (Note that any disturbances within the buffer related to buffer enhancement are permitted and do not constitute construction disturbances.) For instance, you may want to target plantings where limited vegetation exists, or replace existing vegetation where invasive or noxious plant species (see <http://plants.usda.gov/java/noxiousDriver>) have taken over. In the case of invasive or noxious species, you may want to remove and replace them with a diversity of native trees, shrubs, and herbaceous plants that are well-adapted to the climatic, soil, and hydrologic conditions on the site. You are also encouraged to limit the removal of naturally deposited leaf litter, woody debris, and other biomass, as this material contributes to the ability of the buffer to retain water and filter pollutants.

If a portion of the buffer area adjacent to the water of the state is owned by another party and is not under your control, you are only required to retain and protect from construction activities the portion of the buffer area that is under your control. For example, if you comply with compliance alternative 1 (provide and maintain a 50-foot buffer), but 10 feet of land immediately adjacent to the water of the U.S. is owned by a different party than the land on which your construction activities are taking place and you do not have control over that land, you must only retain and protect from construction activities the 40-foot buffer area that occurs adjacent to the property on which your construction activities are taking place. DWQ would consider you to be in compliance with this requirement regardless of the activities that are taking place in the 10-foot area that is owned by a different party than the land on which your construction activities are taking place that you have no control over.

Discharges to the Buffer

You must ensure that all discharges from the area of earth disturbance to the natural buffer are first treated by the site's erosion and sediment controls (for example, you must comply with the Part 2.2.3 requirement to install sediment controls along any perimeter areas of the site that will receive pollutant discharges), **and if necessary to prevent erosion caused by storm water flows within the buffer, you must use velocity dissipation devices.** The purpose of this requirement is to decrease the rate of storm water flow and encourage infiltration so that the pollutant filtering functions of the buffer will be achieved. To comply with this requirement,

construction operators typically will use devices that physically dissipate storm water flows so that the discharge entering the buffer is spread out and slowed down.

SWPPP Documentation

You are required to document in your SWPPP the natural buffer width that is retained. For example, if you are complying with alternative 1, you must specify in your SWPPP that you are providing a 50-foot buffer. Or, if you will be complying with alternative 2, you must document the reduced width of the buffer you will be retaining (and you must also describe the erosion and sediment controls you will use to achieve an equivalent sediment reduction, as required in Part A.2.4 below). Note that you must also show any buffers on your site map in your SWPPP consistent with Part 7.3.3.h. Additionally, if any disturbances related to the exceptions in Part A.2.2 occur within the buffer area, you must document this in the SWPPP.

A.2.4 Guidance for Providing the Equivalent Sediment Reduction as a 50-foot Buffer

This part applies to you if you choose compliance alternative 2 (provide and maintain a buffer that is less than 50 feet that is supplemented by erosion and sediment controls that achieve the sediment load reduction equivalent to a 50-foot buffer) or compliance alternative 3 (implement erosion and sediment controls to achieve the sediment load reduction equivalent to a 50-foot buffer).

Determine Whether it is Feasible to Provide a Reduced Buffer

EPA recognizes that there will be a number of situations in which it will be infeasible to provide and maintain a buffer of any width. While some of these situations may exempt you from the buffer requirement entirely (see A.2.2), if you do not qualify for one of these exemptions, there still may be conditions or circumstances at your site that make it infeasible to provide a natural buffer. For example, there may be sites where a significant portion of the property on which the earth-disturbing activities will occur is located within the buffer area, thereby precluding the retention of natural buffer areas.

Therefore, you should choose compliance alternative 2 if it is feasible for you to retain some natural buffer on your site. (Note: For any buffer width retained, you are required to comply with the requirements in Part A.2.3, above, concerning the retention of vegetation and restricting earth disturbances.) Similarly, if you determine that it is infeasible to provide a natural buffer of any size during construction, you should choose alternative 3.

Design Controls That Provide Equivalent Sediment Reduction as 50-foot Buffer

You must next determine what additional controls must be implemented on your site that, alone or in combination with any retained natural buffer, achieve a reduction in sediment equivalent to that achieved by a 50-foot buffer.

Note that if only a portion of the natural buffer is less than 50 feet, you are only required to implement erosion and sediment controls that achieve the sediment load reduction equivalent to the 50-foot buffer for discharges through that area. You would not be required to provide additional treatment of storm water discharges that flow through 50 feet or more of natural buffer. See Figure A-4.

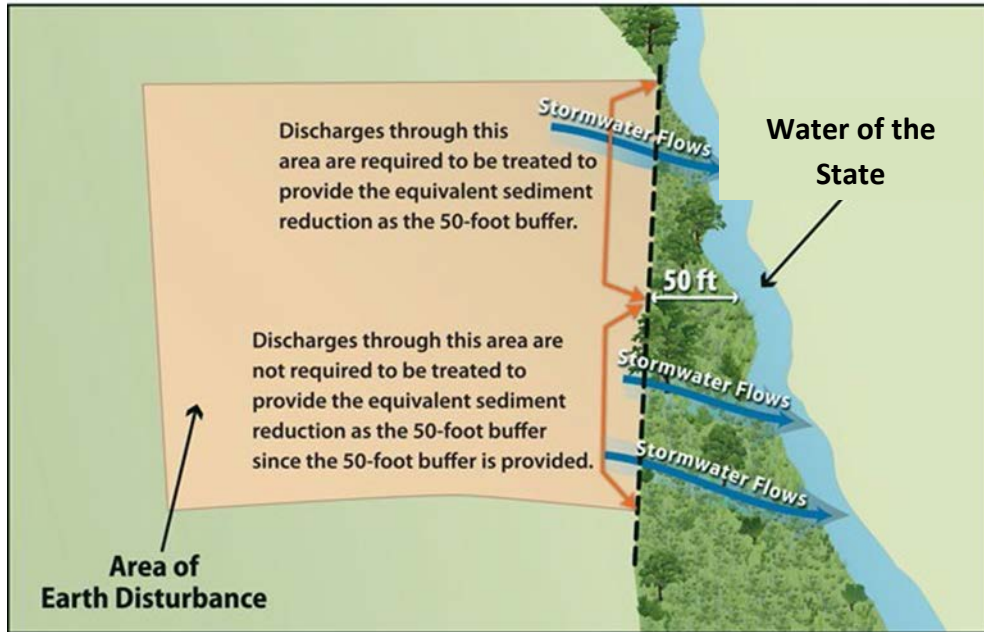

Figure A-4 Example of how to comply with the requirement to provide the equivalent sediment reduction when only a portion of your earth-disturbances discharge to a buffer of less than 50- feet.

Steps to help you meet compliance alternative 2 and 3 requirements are provided below.

Step 1 - Estimate the Sediment Reduction from the 50-foot Buffer

In order to design controls that match the sediment removal efficiency of a 50-foot buffer, you first need to know what this efficiency is for your site. The sediment removal efficiencies of natural buffers vary according to a number of site-specific factors, including precipitation, soil type, land cover, slope length, width, steepness, and the types of erosion and sediment controls used to reduce the discharge of sediment prior to the buffer. EPA has simplified this calculation by developing buffer performance tables covering a range of vegetation and soil types for the areas covered by the CGP. See Attachment 1 of this Appendix, Tables A-8 and A-9. Note: buffer performance values in Tables A-8 and A-9 represent the percent of sediment captured through the use of perimeter controls (e.g., silt fences) and 50-foot buffers at disturbed sites of fixed proportions and slopes.³⁹ The number of tables has been reduced since many were irrelevant and

³⁹ EPA used the following when developing the buffer performance tables:

- The sediment removal efficiencies are based on the U.S. Department of Agriculture’s RUSLE2 (“Revised Universal Soil Loss Equation 2”) model for slope profiles using a 100-foot long denuded slopes.
- Sediment removal was defined as the annual sediment delivered at the downstream end of the 50-foot natural buffer (tons/yr/acre) divided by the annual yield from denuded area (tons/yr/acre).
- As perimeter controls are also required by the CGP, sediment removal is in part a function of the reduction due to a perimeter control (i.e., silt fence) located between the disturbed portion of the site and the upstream edge of the natural buffer and flow traveling through a 50-foot buffer of undisturbed natural vegetation.
- It was assumed that construction sites have a relatively uniform slope without topographic features that accelerate the concentration for erosive flows. (footnote continues on next page)

Table A-8 for Idaho most closely represents northern Utah, and Table A-9 for New Mexico most closely represents southern Utah.

Using Table A-8 for northern Utah or A-9 for southern Utah (see Attachment 1 of this Appendix), you can determine the sediment removal efficiency of a 50-foot buffer for your geographic area by matching the vegetative cover type that best describes your buffer area and the type of soils that predominate at your site. For example, if your site is located in Idaho (northern Utah --Table A-8), and your buffer vegetation corresponds most closely with that of tall fescue grass, and the soil type at your site is best typified as sand, your site's sediment removal efficiency would be 44 percent.

In this step, you should choose the vegetation type in the tables that most closely matches the vegetation that would exist naturally in the buffer area on your site regardless of the condition of the buffer. However, because you are not required to plant any additional vegetation in the buffer area, in determining what controls are necessary to meet this sediment removal equivalency in Step 2 below, you will be able to take credit for this area as a fully vegetated "natural buffer."

Similarly, if a portion of the buffer area adjacent to the water of the state is owned by another party and is not under your control, you can treat the area of land not under your control as having the equivalent vegetative cover and soil type that predominates on the portion of the property on which your construction activities are occurring.

For example, if your earth-disturbances occur within 50 feet of a water of the state, but the 10 feet of land immediately adjacent to the water of the state is owned by a different party than the land on which your construction activities are taking place and you do not have control over that land, you can treat the 10 foot area adjacent to the stream as having the equivalent soil and vegetation type that predominates in the 40 foot area under your control. You would then make the same assumption in Step 2 for purposes of determining the equivalent sediment removal (which would be 44% in this case).

Alternatively, you may do your own calculation of the effectiveness of the 50-foot buffer based upon your site-specific conditions, and may use this number as your sediment removal equivalency standard to meet instead of using Tables A-8 and A-9. This calculation must be documented in your SWPPP.

Step 2 - Design Controls That Match the Sediment Removal Efficiency of the 50-foot Buffer

-
- It was assumed that vegetation has been removed from the disturbed portion of the site and a combination of cuts and fills have resulted in a smooth soil surface with limited retention of near-surface root mass.

To represent the influence of soil, EPA analyzed 11 general soil texture classifications in its evaluation of buffer performance. To represent different types of buffer vegetation, EPA evaluated 4 or more common vegetative types for each state/territory covered under the permit. For each vegetation type evaluated, EPA considered only permanent, non-grazed, and non-harvested vegetation, on the assumption that a natural buffer adjacent to the water of the U.S. will typically be undisturbed. EPA also evaluated slope steepness and found that sediment removal efficiencies present in Tables A-8 and A-9 are achievable for slopes that are less than nine percent.

Once you determine the estimated sediment removal efficiency of a 50-foot buffer for your site in Step 1, you must next select storm water controls that will provide an equivalent sediment load reduction. These controls can include the installation of a single control, such as a sediment pond or additional perimeter controls, or a combination of storm water controls. Whichever control(s) you select, you must demonstrate in your SWPPP that the controls will provide at a minimum the same sediment removal capabilities as a 50-foot natural buffer (Step 1). You may take credit for the removal efficiencies of your required perimeter controls in your calculation of equivalency, because these were included in calculating the buffer removal efficiencies in Tables C-8 through C-9. (Note: You are reminded that the controls must be kept in effective operating condition until you complete final stabilization on the disturbed portions of the site discharging to the water of the state)

To make the determination that your controls and/or buffer area achieve an equivalent sediment load reduction as a 50-foot buffer, you should use a model or other type of calculation. As mentioned above, there are a variety of models available that can be used to support your calculation, including USDA's RUSLE-series programs and the WEPP erosion model, SEDCAD, SEDIMOT, or other models. An example is provided in Attachment 3 to help illustrate how this determination could be made.

If you retain a buffer of less than 50 feet, you may take credit for the removal that will occur from the reduced buffer and only need to provide additional controls to make up the difference between the removal efficiency of a 50 foot buffer and the removal efficiency of the narrower buffer. For example, if you retain a 30 foot buffer, you can account for the sediment removal provided by the 30 foot buffer retained, and you will only need to design controls to make up for the additional removal provided by the 20 feet of buffer that is not being provided. To do this, you would plug the width of the buffer that is retained into RUSLE or another model, along with other storm water controls that will together achieve a sediment reduction equivalent to a natural 50-foot buffer.

As described in Step 1 above, you can take credit for the area you retained as a "natural buffer" as being fully vegetated, regardless of the condition of the buffer area.

For example, if your earth-disturbances occur 30 feet from a water of the state, but the 10 feet of land immediately adjacent to the water of the U.S. is owned by a different party than the land on which your construction activities are taking place and you do not have control over that land, you can treat the 10-foot area as a natural buffer, regardless of the activities that are taking place in the area. Therefore, you can assume (for purposes of your equivalency calculation) that your site is providing the sediment removal equivalent of a 30-foot buffer, and you will only need to design controls to make up for the additional removal provided by the 20-foot of buffer that is not being provided.

Step 3 - Document How Site-Specific Controls Will Achieve the Sediment Removal Efficiency of the 50-foot Buffer

In Steps 1 and 2, you determined both the expected sediment removal efficiency of a 50-foot buffer at your site, and you used this number as a performance standard to design controls to be installed at your site, which alone or in combination with any retained natural buffer, achieves

the expected sediment removal efficiency of a 50-foot buffer at your site. The final step is to document in your SWPPP the information you relied on to calculate the equivalent sediment reduction as an undisturbed natural buffer.

DWQ will consider your documentation to be sufficient if it generally meets the following:

- For Step 1, refer to the table in Attachment 1 that you used to derive your estimated 50-foot buffer sediment removal efficiency performance. Include information about the buffer vegetation and soil type that predominate at your site, which you used to select the sediment load reduction value in Tables A-8 and A-9. Or, if you conducted a site-specific calculation for sediment removal efficiency, provide the specific removal efficiency, and the information you relied on to make your site-specific calculation.
- For Step 2, (1) Specify the model you used to estimate sediment load reductions from your site; and (2) the results of calculations showing how your controls will meet or exceed the sediment removal efficiency from Step 1.

If you choose compliance alternative 3, you must also include in your SWPPP a description of why it is infeasible for you to provide and maintain an undisturbed natural buffer of any size.

A.3 SMALL RESIDENTIAL LOT COMPLIANCE ALTERNATIVES

EPA has developed two additional compliance alternatives applicable only to “small residential lots” that are unable to provide and maintain a 50 foot buffer.

The following steps describe how a small residential lot operator would achieve compliance with one these 2 alternatives.

A small residential lot (Common Plan Lot) is a lot or grouping of lots being developed for residential purposes that will disturb less than 1 acre of land, but that is part of a larger residential project that will ultimately disturb greater than or equal to 1 acre.

A.3.1 Small Residential Lot Compliance Alternative Eligibility

In order to be eligible for the small residential lot compliance alternatives, the following conditions must be met:

6. The lot or grouping of lots meets the definition of “small residential lot”; and
7. The operator must follow the guidance for providing and maintaining a natural buffer in Part A.2.3 of this Appendix, including:
 - Ensure that all discharges from the area of earth disturbance to the natural buffer are first treated by the site’s erosion and sediment controls, and use velocity dissipation devices if necessary to prevent erosion caused by storm water within the buffer;
 - Document in the SWPPP the natural buffer width retained on the property, and show the buffer boundary on your site plan; and

- Delineate, and clearly mark off, with flags, tape, or other similar marking device, all natural buffer areas.

A.3.2. Small Residential Lot Compliance Alternatives

You must next choose from one of two small residential lot compliance alternatives and implement the storm water control practices associated with that alternative.

Note: The compliance alternatives provided below are not mandatory. Operators of small residential lots can alternatively choose to comply with the any of the options that are available to other sites in Part 2.2.1.a and A.2.1 of this Appendix.

Small Residential Lot Compliance Alternative 1

Alternative 1 is a straightforward tiered-technology approach that specifies the controls that a small residential lot must implement based on the buffer width retained. To meet the requirements of small residential lot compliance alternative 1, you must implement the controls specified in Table A-1 based on the buffer width to be retained. See footnote 40, below, for a description of the controls you must implement.

For example, if you are an operator of a small residential lot that will be retaining a 35-foot buffer and you choose Small Residential Lot Compliance Alternative 1, you must implement double perimeter controls between earth disturbances and the water of the state.

In addition to implementing the applicable control, you must also document in your SWPPP how you will comply with small residential lot compliance alternative 1.

Table A-1 Alternative 1 Requirements⁴⁰

Retain 50 foot Buffer	Retain <50 and >30 Buffer	Retain ≤30 foot Buffer
No Additional Requirements	Double Perimeter Controls	Double Perimeter Controls and 7-Day Site Stabilization

Small Residential Lot Compliance Alternative 2

Alternative 2 specifies the controls that a builder of a small residential lot must implement based on both the buffer width retained and the site’s sediment discharge risk. By incorporating the

⁴⁰Description of Additional Controls Applicable to Small Residential Lot Compliance Alternatives 1 and 2:

- **No Additional Requirements:** If you implement a buffer of 50 feet or greater, then you are not subject to any additional requirements. Note that you are required to install perimeter controls between the disturbed portions of your site and the buffer in accordance with Part 2.2.3.
- **Double Perimeter Control:** In addition to the reduced buffer width retained on your site, you must provide a double row of perimeter controls between the disturbed portion of your site and the water of the U.S. spaced a minimum of 5 feet apart.
- **Double Perimeter Control and 7-Day Site Stabilization:** In addition to the reduced buffer width retained on your site and the perimeter control implemented in accordance with Part 2.2.3, you must provide a double row of perimeter controls between the disturbed portion of your site and the water of the U.S. spaced a minimum of 5 feet apart, and you are required to complete the stabilization activities specified in Parts 2.2.14 within 7 calendar days of the temporary or permanent cessation of earth-disturbing activities.

sediment risk, this approach may result in the implementation of controls that are more appropriate for the site’s specific conditions.

Step 1 – Determine Your Site’s Sediment Risk Level

To meet the requirements of Alternative 2, you must first determine your site’s sediment discharge “risk level” based on the site’s slope, location, and soil type. To help you to determine your site’s sediment risk level, EPA developed five different tables for different slope conditions. You should select the table that most closely corresponds to your site’s average slope.

For example, if your site’s average slope is 7 percent, you should use Table C-4 to determine your site’s sediment risk.

After you determine which table applies to your site, you must then use the table to determine the “risk level” (e.g., “low”, “moderate”, or “high”) that corresponds to your site’s location and predominant soil type.⁴¹

For example, based on Table C-3, a site located in Northern Utah with a 4 percent average slope and with predominately sandy clay loam soils would fall into the “low” risk level.

Table A-2 Risk Levels for Sites with Average Slopes of ≤ 3 Percent

Soil Type Location	Clay	Silty Clay Loam or Clay- Loam	Sand	Sandy Clay Loam, Loamy Sand or Silty Clay	Loam, Silt, Sandy Loam or Silt Loam
Idaho (Northern Utah)	Low	Low	Low	Low	Low
New Mexico (Southern Utah)	Low	Low	Low	Low	Low

Table A-3 Risk Levels for Sites with Average Slopes of > 3 Percent and ≤ 6 Percent

Soil Type Location	Clay	Silty Clay Loam or Clay- Loam	Sand	Sandy Clay Loam, Loamy Sand or Silty Clay	Loam, Silt, Sandy Loam or Silt Loam
Idaho (Northern Utah)	Low	Low	Low	Low	Low
New Mexico (Southern Utah)	Low	Low	Low	Low	Moderate

⁴¹ One source for determining your site’s predominant soil type is the USDA’s Web Soil Survey located at <http://websoilsurvey.nrcs.usda.gov/app/WebSoilSurvey.aspx>.

Table A-4 Risk Levels for Sites with Average Slopes of > 6 Percent and ≤ 9 Percent

Soil Type Location	Clay	Silty Loam or Clay-Loam	Sand	Sandy Clay Loam, Loamy Sand or Silty Clay	Loam, Silt, Sandy Loam or Silt Loam
Idaho (Northern Utah)	Low	Low	Low	Low	Low
New Mexico (Southern Utah)	Low	Low	Low	Low	Moderate

Table A-5 Risk Levels for Sites with Average Slopes of > 9 Percent and ≤ 15 Percent

Soil Type Location	Clay	Silty Loam or Clay-Loam	Sand	Sandy Clay Loam, Loamy Sand or Silty Clay	Loam, Silt, Sandy Loam or Silt Loam
Idaho (Northern Utah)	Low	Low	Low	Low	Low
New Mexico (Southern Utah)	Low	Moderate	Low	Moderate	Moderate

Table A-6 Risk Levels for Sites with Average Slopes of > 15 Percent

Soil Type Location	Clay	Silty Loam or Clay-Loam	Sand	Sandy Clay Loam, Loamy Sand or Silty Clay	Loam, Silt, Sandy Loam or Silt Loam
Idaho (Northern Utah)	Low	Low	Low	Low	Moderate
New Mexico (Southern Utah)	Moderate	Moderate	Moderate	Moderate	High

Step 2 – Determine Which Additional Controls Apply

Once you determine your site’s “risk level”, you must next determine the additional controls you need to implement on your site, based on the width of buffer you plan to retain. Table A-7

specifies the requirements that apply based on the “risk level” and buffer width retained. See footnote 40, above, for a description of the additional controls that are required.

For example, if you are the operator of a small residential lot that falls into the “moderate” risk level, and you decide to retain a 20-foot buffer, using Table A-7 you would determine that you need to implement double perimeter controls to achieve compliance with small residential lot compliance alternative 2.

You must also document in your SWPPP your compliance with small residential lot compliance alternative 2.

Table A-7. Alternative 2 Requirements

Risk Level Based on Estimated Soil Erosion	Retain ≥ 50' Buffer	Retain <50' and >30' Buffer	Retain ≤30' and >10' Buffer	Retain ≤ 10' Buffer
Low Risk	No Additional Requirements	No Additional Requirements	Double Perimeter Control	Double Perimeter Control
Moderate Risk	No Additional Requirements	Double Perimeter Control	Double Perimeter Control	Double Perimeter Control and 7-Day Site Stabilization
High Risk	No Additional Requirements	Double Perimeter Control	Double Perimeter Control and 7-Day Site Stabilization	Double Perimeter Control and 7-Day Site Stabilization

ATTACHMENT 1

Sediment Removal Efficiency Tables⁴²

EPA recognizes that very high removal efficiencies, even where theoretically achievable by a 50-foot buffer, may be very difficult to achieve in practice using alternative controls. Therefore in the tables below, EPA has limited the removal efficiencies to a maximum of 90%. Efficiencies that were calculated at greater than 90% are shown as 90%, and this is the minimum percent removal that must be achieved by alternative controls.

For the Utah CGP only the tables for Idaho and New Mexico are shown. The table for Idaho substitutes for northern Utah and the table for New Mexico substitutes for southern Utah.

Table A-8 Estimated 50-foot Buffer Performance in Idaho* (Northern Utah)

Type of Buffer Vegetation**	Estimated % Sediment Removal				
	Clay	Silty Clay Loam or Clay-Loam	Sand	Sandy Clay Loam, Loamy Sand or Silty Clay	Loam, Silt, Sandy Loam or Silt Loam
Tall Fescue Grass	42	52	44	48	85
Medium-density Weeds	28	30	28	26	60
Low-density Warm-season Native Bunchgrass (i.e., Grama Grass)	25	26	24	24	55
Northern Mixed Prairie Grass	28	30	28	26	50
Northern Range Cold Desert Shrubs	28	28	24	26	50

* Applicable for sites with less than nine percent slope

** Characterization focuses on the under-story vegetation

Table A-9 Estimated 50-foot Buffer Performance in New Mexico* (Southern Utah)

Type of Buffer Vegetation **	Estimated % Sediment Removal				
	Clay	Silty Clay Loam or Clay-Loam	Sand	Sandy Clay Loam, Loamy Sand or Silty Clay	Loam, Silt, Sandy Loam or Silt Loam
Tall Fescue grass	71	85	80	86	90

⁴² The buffer performances were calculated based on a denuded slope upgradient of a 50-foot buffer and a perimeter controls, as perimeter controls are a standard requirement (see Part 2.2.3).

CONSTRUCTION GENERAL STORM WATER PERMIT (CGP)

Medium-density Weeds	56	73	55	66	78
Low-density Warm-season Native Bunchgrass (i.e., Grama Grass)	53	70	51	62	67
Southern Mixed Prairie Grass	53	71	52	63	50
Southern Range Cold Desert Shrubs	56	73	55	65	53

* Applicable for sites with less than nine percent slope

** Characterization focuses on the under-story vegetation

ATTACHMENT 2

Using the Sediment Removal Efficiency Tables – Questions and Answers

– **What if my specific buffer vegetation is not represented in Tables A-8 and A-9?** Tables A-8 and A-9 provide a range of factors affecting buffer performance; however, there are likely instances where the specific buffer vegetation type on your site is not listed. If you do not see a description of the type of vegetation present at your site, you should choose the vegetation type that most closely matches the vegetation type on your site. You can contact your local Cooperative Extension Service Office (<http://nifa.usda.gov/partners-and-extension-map>) for assistance in determining the vegetation type in Tables C-8 through C-9 that most closely matches your site-specific vegetation.

– **What if there is high variability in local soils?** EPA recognizes that there may be a number of different soil type(s) on any given construction site. General soil information can be obtained from USDA soil survey reports (<http://websoilsurvey.nrcs.usda.gov>) or from individual site assessments performed by a certified soil expert. Tables A-8 and A-9 present eleven generic soil texture classes, grouping individual textures where EPA has determined that performance is similar. If your site contains different soil texture classes, you should use the soil type that best approximates the predominant soil type at your site.

– **What if my site slope is greater than 9 percent after final grade is reached?** As indicated in the buffer performance tables, the estimated sediment removal efficiencies are associated with disturbed slopes of up to 9 percent grade. Where your graded site has an average slope of greater than 9 percent, you should calculate a site-specific buffer performance.

– **How do I calculate my own estimates for sediment reduction at my specific site?** If you determine that it is necessary to calculate your own sediment removal efficiency using site-specific conditions (e.g., slopes at your site are greater than 9 percent), you can use a range of available models that are available to facilitate this calculation, including USDA's RUSLE- series programs and the WEPP erosion model, SEDCAD, SEDIMOT, or other equivalent models.

– **What is my estimated buffer performance if my site location is not represented by Tables A-8 and A-9?** If your site is located in an area not represented by Tables A-8 and A-9, you should use the table that most closely approximates conditions at your site (Table A-8 generally represents northern Utah, Table A-9 generally represents southern Utah). You may instead choose to conduct a site-specific calculation of the buffer performance.

– **What if only a portion of my site drains to the buffer area?** If only a portion of your site drains to a water of the State, where that water is within 50 feet of your earth disturbances, you are only required to meet the equivalency requirement for the storm water flows corresponding to those portions of the site. See Attachment 3 for an example of how this is expected to work.

ATTACHMENT 3

Example of How to Use the Sediment Removal Efficiency Tables

Arid Location With Pre-existing Disturbances in the Natural Buffer (6.5 acre site located in southern Utah)

An operator of a site in southern Utah determines that it is not feasible to provide a 50-foot buffer, but a 28-foot buffer can be provided. Because the operator will provide a buffer that is less than 50 feet, the operator must determine which controls, in combination with the 28-foot buffer, achieve a sediment load reduction equivalent to the 50-foot buffer. In this example, the project will disturb 6.5 acres of land, but only 1.5 acres of the total disturbed area drains to the buffer area. Within the 28-foot buffer area is a preexisting concrete walkway. The equivalence analysis starts with Step 1 in Part A.2.4 of this Appendix with a review of the southern Utah buffer performance (Table A-9). The operator determines that the predominate vegetation type in the buffer area is prairie grass, the soil type is similar to silt, and the site is of a uniform, shallow slope (e.g., 3 percent grade). Although the operator will take credit for the disturbance caused by the concrete walkway as a natural buffer in Step 2, here the operator can treat the entire buffer area as being naturally vegetated with prairie grass. Based on this information, the operator refers to Table A-9 to estimate that the 50-foot buffer would retain 50 percent of eroded soil.

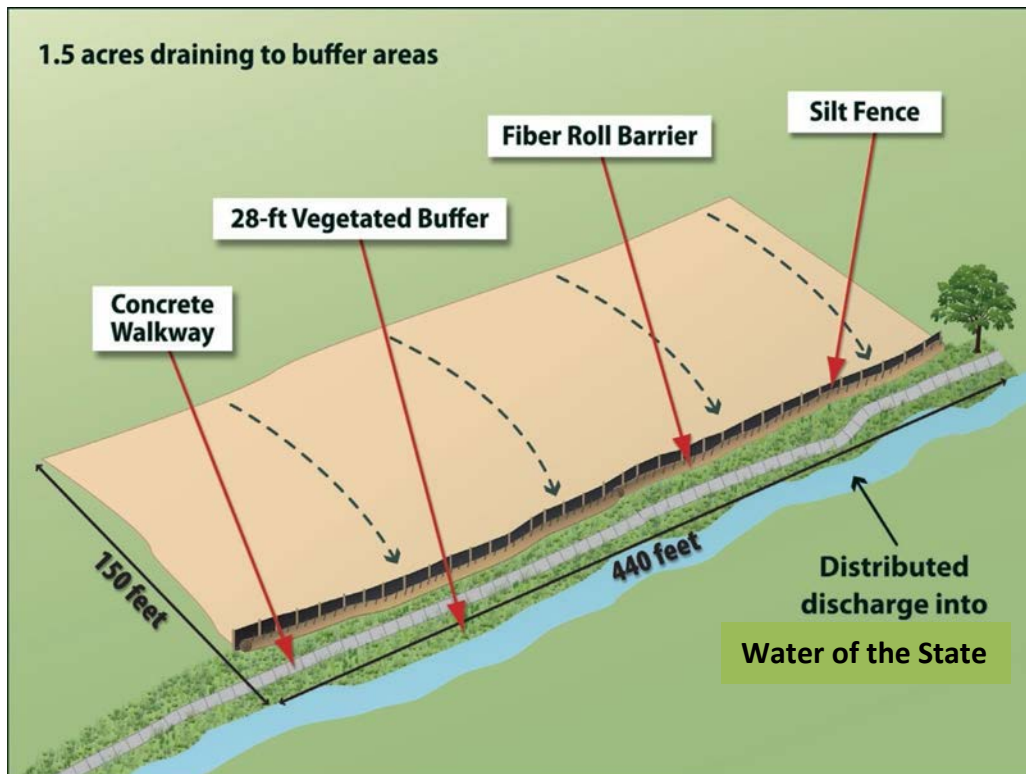

Figure A-5 Example – Equivalent Sediment Load Reductions at a 6.5 ac Site in Southern Utah.

The second step is to determine, based on the 50 percent sediment removal efficiency found in Table A-9, what sediment controls, in combination with the 28-foot buffer area, can be implemented to reduce

sediment loads by 50 percent or more. The operator does not have to account the reduction in buffer function caused by the preexisting walkway, and can take credit for the entire 28-foot buffer being fully vegetated in the analysis. For this example, using the RUSLE2 profile model, the operator determined that installing a fiber roll barrier between the silt fence (already required by Part 2.2.3) and the 28-foot buffer will achieve an estimated 84 percent sediment removal efficiency. See Figure A-5. Note that this operator is subject to the requirement in Part A.2.3 of this Appendix to ensure that discharges through the silt fence, fiber roll barrier, and 28-foot buffer do not cause erosion within the buffer. The estimated sediment reduction is greater than the required 50 percent; therefore the operator will have met the buffer alternative requirement.