

WESTERN WEBER PLANNING COMMISSION

MEETING AGENDA

December 8, 2020

5:00 p.m.

Join Zoom Meeting

<https://us02web.zoom.us/j/87386618567>

Meeting ID: 873 8661 8567

One tap mobile

+13462487799,,87386618567# US (Houston)

+16699006833,,87386618567# US (San Jose)

- *Pledge of Allegiance*
- *Roll Call:*

1. **Minutes:** November 10, 2020

2. **Consent Agenda**

2.1 CUP 2020-19: Consideration and action on a conditional use permit application for Christensen Fabrication Shop, a fabrication shop making parts for the airline, mining, and construction industries.

Applicant: Nathan Christensen and John Bowen; Staff Presenter: Felix Lleverino

3. **Petitions, Applications, and Public Hearings:**

Administrative items

3.1 CUP 2020-18: Consideration and action for a conditional use request for Winston Park, a Planned Residential Unit Development consisting of 57 residential units, and a 17.693 acre open space parcel.

Applicant: Wade Rumsey, Staff Presenter: Tammy Aydelotte

3.2 CUP2020-16: Consideration and action for a conditional use request for a basement accessory apartment within an existing single-family dwelling located at 2259 S. 3750 W., Ogden.

Applicant: Dale McCrary; Staff Presenter: Scott Perkes

3.3 LVS102220: Consideration and action on final approval of Suncrest Meadows Subdivision phase 3

Applicant Representative: Carson Jones; Staff Presenter: Steve Burton

4. **Petitions, Applications, and Public Hearings:**

Legislative items

4.1 ZTA2020-05: Discussion and action on a recommendation to the Weber County Commission regarding potential scenarios to amend § 108-7-25 of the Weber County Code regarding short-term rentals.

Staff Presenter: Scott Perkes

5. **Public Comment for Items not on the Agenda:**

6. **Remarks from Planning Commissioners:**

7. **Planning Director Report:**

8. **Remarks from Legal Counsel:**

Adjourn

*The regular meeting will be held in the Weber County Commission Chambers, in the Weber Center, 1st Floor,
2380 Washington Blvd., Ogden, Utah.*

&

Via Zoom Video Conferencing at the link listed above.

A Pre-Meeting will be held at 4:30 p.m. The agenda for the pre-meeting consists of discussion of the same items listed above, on the agenda for the meeting.

No decisions are made in the pre-meeting, but it is an open, public meeting.

In compliance with the Americans with Disabilities Act, persons needing auxiliary services for these meetings should call the Weber County Planning Commission at 801-399-8791

Meeting Procedures

Outline of Meeting Procedures:

- ❖ The Chair will call the meeting to order, read the opening meeting statement, and then introduce the item.
- ❖ The typical order is for consent items, old business, and then any new business.
- ❖ Please respect the right of other participants to see, hear, and fully participate in the proceedings. In this regard, anyone who becomes disruptive, or refuses to follow the outlined procedures, is subject to removal from the meeting.

Role of Staff:

- ❖ Staff will review the staff report, address the approval criteria, and give a recommendation on the application.
- ❖ The Staff recommendation is based on conformance to the general plan and meeting the ordinance approval criteria.

Role of the Applicant:

- ❖ The applicant will outline the nature of the request and present supporting evidence.
- ❖ The applicant will address any questions the Planning Commission may have.

Role of the Planning Commission:

- ❖ To judge applications based upon the ordinance criteria, not emotions.
- ❖ The Planning Commission's decision is based upon making findings consistent with the ordinance criteria.

Public Comment:

- ❖ The meeting will then be open for either public hearing or comment. Persons in support of and in opposition to the application or item for discussion will provide input and comments.
- ❖ The commission may impose time limits for comment to facilitate the business of the Planning Commission.

Planning Commission Action:

- ❖ The Chair will then close the agenda item from any further public comments. Staff is asked if they have further comments or recommendations.
- ❖ A Planning Commissioner makes a motion and second, then the Planning Commission deliberates the issue. The Planning Commission may ask questions for further clarification.
- ❖ The Chair then calls for a vote and announces the decision.

Commenting at Public Meetings and Public Hearings

Address the Decision Makers:

- ❖ When commenting please step to the podium and state your name and address.
- ❖ Please speak into the microphone as the proceedings are being recorded and will be transcribed to written minutes.
- ❖ All comments must be directed toward the matter at hand.
- ❖ All questions must be directed to the Planning Commission.
- ❖ The Planning Commission is grateful and appreciative when comments are pertinent, well organized, and directed specifically to the matter at hand.

Speak to the Point:

- ❖ Do your homework. Obtain the criteria upon which the Planning Commission will base their decision. Know the facts. Don't rely on hearsay and rumor.
- ❖ The application is available for review in the Planning Division office.
- ❖ Speak to the criteria outlined in the ordinances.
- ❖ Don't repeat information that has already been given. If you agree with previous comments, then state that you agree with that comment.
- ❖ Support your arguments with relevant facts and figures.
- ❖ Data should never be distorted to suit your argument; credibility and accuracy are important assets.
- ❖ State your position and your recommendations.

Handouts:

- ❖ Written statements should be accurate and either typed or neatly handwritten with enough copies (10) for the Planning Commission, Staff, and the recorder of the minutes.
- ❖ Handouts and pictures presented as part of the record shall be left with the Planning Commission.

Remember Your Objective:

- ❖ Keep your emotions under control, be polite, and be respectful.
- ❖ It does not do your cause any good to anger, alienate, or antagonize the group you are standing in front of.

Minutes for Western Weber Planning Commission meeting of November 10, 2020, held in the Weber County Commission Chamber, 2380 Washington Blvd. Floor 1 Ogden UT at 5:00 pm & Via Zoom Video Conferencing

Members Present: Bren Edwards-Chair
Greg Bell-Vice Chair
Wayne Andreotti
Andrew Favero
Bruce Nilson
Sarah Wichern
Jed McCormick

Staff Present: Rick Grover, Planning Director; Charlie Ewert, Principle Planner; Felix Lleverino, Planner II; Scott Perkes, Planner II; Tammy Aydelotte, Planner II; Matt Wilson, Legal Counsel; Marta Borchert, Secretary

- Pledge of Allegiance
- Roll Call

Chair Edwards states that Commissioner Borklund is present at the Commission Chamber. He would like to recognize her for all her years of service. Director Grover states that she served many years and was very faithful. Not only has she been gratuitous that way, but she is currently serving on the Board of Adjustments. She is continuing her public service, her knowledge in Planning and helping the County has been amazing. She was always making comments that are spot on and applicable and germane. She served as chair for the Planning Commission. He thanks Jannette Borklund. Chair Edwards thanks Jannette Borklund for her service on the Planning Commission. She always brought a lot of great information and great expertise to the table. He states that he appreciates all her years of service and her continuing her service with the Board of Adjustments. Commissioner Andreotti seconds that. He states that he enjoyed working with Jannette. She is a great person and will do very well on the Board of Adjustments.

Commissioner Bell asks if they can move the **Public Comment for items not on the agenda**. Mr. Wilson states that if the public wants to comment during this period the comments cannot be for items on the agenda. Planning Commissioners agree to move the **Public Comment for items not on the agenda** and place it after item **Approval of minutes**.

Minutes: November 12, 2019 & October 13, 2020. Minutes approved as presented.

Chair Edwards asks if there are any conflicts of interest or ex parte communication to disclose. Commissioner Bell states that he may have a conflict of interest because he lives near the Taylor Landing Subdivision and he received a notice for the hearing from Weber County concerning this meeting. Mr. Wilson states that he advised Commissioner Bell to declare a conflict of interest it is good to disclose this. He notes that there is no hard and fast rule of the vicinity of a project, but the further the property is the less of a conflict there is. If there is an apparent conflict the remaining Planning Commissioner may vote to decide whether he should be allowed to participate. Chair Edwards asks if there any comments concerning this. Commissioner Wichern states Commissioner Bell would represent his community as long as he is not financially involved she is okay with his participation. She states that the whole community near and far should be represented. Commissioner Nilson states that he agrees with Commissioner Wichern. Commissioner Andreotti states that he also agrees.

MOTION: Commissioner Wichern moves to allow Commissioner Bell to participate in administrative items 3.2 and 3.3 concerning the Taylor Landing Cluster Subdivision. Commissioner Nilson seconds. Motion carries (6-0).

Commission Nilson states that he lives near the Highland Bluff estates, and notes that he does not feel he has a conflict of interest. He states that he has no financial interest. Commissioner Wichern states that she is in the neighborhood as well but she did not receive a notice and she notes that she would not consider it a conflict. Mr. Wilson states that there is more than just a financial

conflict of interest, he notes that there was a training on this recently and he would be happy to provide the training again. He notes that the reason that Commission Bell was advised to disclose was that he lives so close. He notes that Commissioner Wichern made a good point, concerning the notification area then they might not need to disclose a conflict. Commissioner Nilson states that he did not receive a notice.

Public Comment for Items not on the Agenda:

Kenyon Dove Downton Ogden, states that he is an attorney at Smith and Knowles law firm. He states that he represents Ms. Shae Bitton and other interested parties. He would like to comment on something that is not on the agenda but is related to the Taylor Landing Subdivision. He wants to make sure the Planning Commission aware that there is pending litigation against Weber County concerning Taylor Landings preliminary approval. He states that he would like to bring up the potential conflict of interest concerning Commissioner Favero and Tom Favero. Tom Favero is the farmer that is intended to farm the open space in the Taylor Landing Subdivision. He believes that he has written evidence from the states that Commission Favero has a pecuniary interest in Favero Farms LLC. He states that he wanted to bring these items to the attention of the Planning Commission and would request that this item be tabled until the lawsuit can be resolved to avoid unnecessary cost to Weber County Taxpayers and if the Court finds in favor of his client everything done will be undone including the appeal by the County Commission. Mr. Wilson states that he has been unable to reach Mr. Dove for the past 24 hrs. and has been unable to respond to him. Regarding the conflict of interest, he has received personal guarantees that Commissioner Favero is not part of that the Favero Farms LLC. Mr. Dove can provide the information that he has. He notes that the reason they are moving forward with the consideration of final approval is that it is the applicant's wishes. The applicant has been informed that it is pending litigation, if they want to proceed they are subject to the court's decision. If they receive final approval and the court decides in favor of the Plaintiff everything would be undone. It is up to the applicant if they want to proceed or not.

Boyd Cook asks if he can interject concerning the Favero's. Chair Edwards states that this is a public comment section for items not on the agenda and the previous item should not have been made because it concerns the Taylor Landing Subdivision which is on the agenda.

Chair Edwards asks if there are any comments for items not on the agenda. There is none.

Consent items.

CUP 2020-17: A request for approval of Conditional Use Permit to remove an older water tank and build two new 375,000- gallon water tanks that serve Uintah City.

MOTION: Bruce Nilson moves to approve CUP 2020-17: A request for approval of Conditional Use Permit to remove an older water tank and build two new 375,000- gallon water tanks that serve Uintah City as presented. Commissioner Wichern seconds. Motion carries (7-0).

3.1 LVH 091820: Consideration and action on a request for preliminary approval of Highlands Bluff Estates Phase 1, 1st Amendment, a subdivision proposal to create a 12 lot residential development.

Mr. Lleverino states that this is a standard subdivision for the zone. It is designed to meet the minimum standards for the R-1-12 zone. The minimum lot size would be 12,000 sq. ft. the minimum lot width would be 90 ft. This occupies a property in the Unincorporated Uintah area. The total land acreages for this property is 4.59 acres. Staff looked at subdivision requirements and zoning standards. The proposal creates an intersection off of 2225 East St. All four lots are fronting on that right of way, it terminates a turnaround. This design is also helpful in showing some of the utilities that are existing. It also shows the detention basin area. There is a utility easement running along with lots 1-4. This plan includes relocating that line. What that does is, it allows for those lots to have more usable space for residential development on those lots. He notes that the developer is present, if they want to make some comments they can do so at this time.

Randy Moore states that the proposal meets all of the requirements of the R-1-12 zone. There was a question in the pre-meeting concerning the geotechnical report. There is a copy of this in the staff report. He states that there were no big issues or concerns found in this study. These are large lots they average around a third of an acre per lot. Looking at the underground detention, the exact design of that will be presented at final approval. He states that they decided with that design to avoid any kind of an eyesore of a pond and reduce the maintenance. He asks if there are any questions for him.

Commissioner Bell asks how the applicant is planning on rerouting the storm sewer easement. Mr. Moore states that there is an existing storm drain to the South and it picks up the diagonal line across lots 1-4 it goes to the angle to the top right corner. They are going to maintain and keep the existing line that angles to the top right the existing line that goes through lots 1-4 that pipe will be abandoned it will be pulled out of the ground and the easement will be abandoned. The existing pipe in 2225 E the existing inlet will come in and they will run a new pipe down the new cul da sac which will tie into the existing pipe and go out. Each of the lots has plenty of buildable area without any issue. Commissioner Nilson asks if the slope of the road is running from the West to the East. Mr. Moore states that it rises at the beginning at lot 1 to about the middle and then slopes to the east. The detention basin on the top calculations takes that into account.

Chair Edwards asks if there any more questions for Mr. Moore. There are none.

Mr. Lleverino states that upon thorough review it was determined that road connectivity is not feasible in this location and a cul da sac is appropriate. He notes that they also looked at the site development standards for the zone and the existing utilities. The current zoning is R-1-12 is designed for residential type development. This development fits quite well the zoning. Weber County surveying is getting ready to review for final plat. Engineering had comments some civil drawings are to be submitted soon. The Fire Marshalls looked at preliminary, at this time Staff recommends preliminary approval with the conditions and findings stated in the staff report.

Commission Nilson asks since they have gone from a 60 ft. road to a 50 ft. road is the cul da sac is it adequate for them to turn around. Mr. Lleverino states that they are in discussions right now on whether the 50 ft. is appropriate Engineering will have the final say on how that road is going to be designed the developer is willing to abide by the engineering standards in place. The roadway will be designed for safety. Commissioner Nilson states that he doesn't mind the 50 ft road but the cul da sac gets pretty narrow. They could the cul da sac wider. Mr. Moore states that the drawing went to David Reed and he has review the Frontier project and approved the cul da sac. He states that he spoke to him specifically about the size and the fire trucks.

Chair Edwards asks if there are any more questions. There are none.

Chair Edwards opens the public comment. There is no public comment.

MOTION: Commissioner Andreotti moves to approve LVH 091820: Consideration and action on a request for preliminary approval of Highlands Bluff Estates Phase 1, 1st Amendment, a subdivision proposal to create a 12 lot residential development. This recommendation is based on the following conditions: 1. Weber Basin Water Conservancy District shall approve the plans for connection and extension of all-new secondary water lines. This recommendation is based on the following findings: 1. The proposed subdivision complies with South East Western Weber County Plan. 2. The proposed subdivision complies with the applicable County codes. Commissioner Favero seconds. Motion Carries (4-0).

LVT031120: Request for final approval of Taylor Landing Cluster Subdivision Phase 1A, consisting of 28 lots in the A-1 Zone, located at approximately 4000 W 2200 S, Ogden UT.

LVT031120: Request for final approval of Taylor Landing Cluster Subdivision Phase 2, consisting of 20 lots in the A-1 Zone, located at approximately 4000 W 2200 S, Ogden UT.

Scott Perkes states that on the agenda this is listed as two separate items. 3.2 is for phase 1 A and 3.3 is for phase 2. He would like to review the two items together as one they are both parts of the same subdivision. The Planning Commissioner do not have a problem with item 3.2 and 3.3 being combined.

Mr. Perkes states that this is Phase 1A and Phase 2 of the Taylor Landing Cluster Subdivision. There is a total of 48 lots in the first two final phases in addition to the dedication of the open space associated with phases 1 and 2. This is located at approximately 4000 W 2200 S. The total project area for Phase 1 is 8.52 acres. The total project area for phase 2 5.46 acres. This project was initially denied by the Planning Commission. The denial was then appealed by the applicant to the County Commission who then overturned the denial and approved the subdivision as a whole for preliminary approval. He notes that what they are looking to do is plat the first few lots, Phase 1A has 28 lots and Phase 2 has 20 lots. There is a total of 48 lots. Between the two total plats, there is a total of 13.98 acres of developable land. He notes that the applicant is dedicating a proportionate amount of open space with the subdivision as a whole proposed to dedicate 58.25 percent of the net developable area as agricultural open space. For each of the final phases, they will be dedicating a proportionate amount of the whole with each of those phases. In total, they will be dedicating 18.89 acres of open space. This does match the preliminary plan for acreage. The culinary water is being provided by Taylor West Weber and secondary water is being provided by Hooper Irrigation. Central Weber Sewer is providing sewer. The subdivision is consistent with the primary plan and meets the zoning for area and width for each of these lots in the subdivision there was one change to the final plat in phase 1 with regards to the road that is accessing off of 2200 S. In reviewing this the Engineering department requested that a connection not be made to 2200 S because that connection was close to the 3900 W road. The preference was that the 3900 W road be the primary North-South thoroughfare instead of having a connection within phase 1 of Taylor Landing. They looked at different options for either a hammerhead or a cul de sac the preference with the Engineering department was to hammerhead the area. The configuration has been review by Engineering, the Fire Marshal, and Planning and has been approved. In phase 1A where the hammerhead is now located previously made its connection to 2200 S, on the rest of phase 1 will use 3900 W as a North-South connection. He states that they decided to close off the access and hammerhead it for safety reasons at the end of the proposed right of way. There are a couple of conditions of approval. One of which is that the open space parcel which contains a sewer lift station servicing the project be deeded over to the County as part of the first phase and an HOA be formed and that the HOA's CCNR's match the requirements for cluster subdivision there is a few other conditions in there that are pretty standard, but staff recommends approval based on the conditions and findings in the staff report. Mr. Perkes asks if there are any questions.

Commissioner Nilson states that he is unclear on who owns the open space area. Mr. Perkes states that the open space area is allowed to be kept in private ownership as long as they are used for agricultural purposes and dedicated as such. The open space preservation plan is intended to help in private ownership and be leased out for farming activities. Commissioner Nilson asks what the HOA is taking care of. Mr. Perkes states that the HOA will be taking care of a couple of very small pathways and the detention basins that are associated with the subdivision. It will be a small minimal HOA that will be maintaining the small common areas. Commissioner Nilson asks if the developer can sell the open space to someone else. Mr. Perkes states that they could but a conservation easement will be placed on each of the open space agricultural parcels. The use would have to remain agricultural.

Commissioner Bell states there is a significant change from the first plat to the second one when major road access was cut off to a major thoroughfare. They are now routing all traffic to all of the homes through two existing streets. There is no connection to 2200. Mr. Perkes states that they did recognize that it would limit the access for some time. He notes that they worked with the Fire Marshall and they were fine with using the half-width of a road that isn't improved yet and 3900 W could provide alternative access if there were an emergency. The emergency access for the second point would be provided off of 3900 W. they will be making sure that that road has enough base course on it to support any emergency traffic. Commissioner Bell asks if they gained an extra two lot in this process, does that increase their density. Mr. Perkes states that they have not the Road that is no longer stubbing through did add a lot but they lost a lot on either side. The number of lots is staying consistent. There are 156 total lots throughout the entire subdivision. It does look a bit different because of the hammerhead but all of the lots still match the minimums for area and width.

Boyd Cook Nibley UT, states that he is the CFO for Sierra Homes the developer on this project. He thanks Scott Perkes and the Planning team, they have been awesome to work with. He states that the only thing that he wanted to point out is that looking at phase 2 will show more clearly how the access will be granted to phase 1 B. He asks Mr. Perkes to point out how the traffic is going

to flow through the hammerhead. Mr. Perkes states that the proposed 2025 South street will allow for additional traffic to go into the hammerhead. There is another entrance proposed off of 2200 South towards the West side of the development that will be going up and around and completing the horseshoe. Phase 1B will have full access on 3900 W and that will connect to 2200 S as well. There will also be an access mid-block between 3900 W and 4300 W. There will additional connection points in future phases. Commissioner Bell asks if they have to wait until phase 5 for connectivity. Mr. Perkes states that looking at the big picture yes. Commissioner Bell asks if until phase 5 they are going to have 160 homes on one outlet of 4075 W. Mr. Cook states that they are proposing that the next phase will be phase 3 and that connection will go all the way out to the South portion. Mr. Perkes states that they did have this discussion with the Fire Marshall. They did understand that there are going to be over 30 homes on one access they also understood that they will be using 3900 it will be improved slightly so that the base course will be adequate to hold emergency vehicles for emergency use. Director Grover asks if Engineering had any issues with the traffic situation. Mr. Perkes states that they did see it as a temporary bottleneck. It is not the best scenario, but additional connectivity will be available and 3900 W as a way to provide emergency access if needed. The Fire Marshalls and the Engineers were okay with single access and they reviewed the hammerhead and the safety gained by the hammerhead as an acceptable interim issue for overall connectivity in the subdivision. He notes that they did require the hammerhead understanding that there was going to be limited access in the first few phases and would be remedied with the next phase. Director Grover states that the Engineering Division was the one who recommended that this access not occur, not the developer. Commissioner Bell asks what the reasons for the hammerhead as opposed to a through road. Mr. Perkes states that they were looking at the road separation 3900 W it will be more of a thoroughfare and the distance between one of the potential accesses and the distance there was less than 500 ft. This was something that did not look to be safe. The raised median was going to be an issue with snow removal. There was going to be a potential conflict because the intersection at 3900 was going to be a four-way stop and Engineering did not like the idea of the separation. They preferred to see it as a hammerhead closed off instead of the connection being made. Commissioner Bell states that he does not see a half of a road as much of a thoroughfare especially if it dead-ends into open space and it's only a half of a road. Mr. Perkes points out that it is half a road only for now. Commissioner Bell states that it will be that way for a long time and there is no way of knowing how long that is going to be. Mr. Perkes states that before they would be able to plat Phase 1B it would have to become a full-width road. They would not be able to move forwards with Phase 1B without that road meeting the County standard. The applicant is currently working with the adjacent property owner to secure that ability to make a full County width road before the phase 1B final plat is approved.

Mr. Cook states that to get any of the phases approved they will also be putting in the lift station and they have to make sure that happens at the same time as the development.

Chair Edwards asks if there are any more questions or comments from the Planning Commissioners.

Commissioner Bell states that he thought there was a connectivity plan or ordinance that forced a certain value. He asks if there was an analysis based on this. Mr. Perkes states that that ordinance has not been approved yet, it is not part of the code at the moment. Charlie Ewert states that they have been in the process for the better part of a year. I will come up again in another couple of months for final vetting. Mr. Perkes notes that some connectivity is required by the existing code and for this reason, the applicant was required to provide midblock access pathways to facilitate the connectivity. That was a component that was review as the initial subdivision approval.

Chair Edwards asks if there are any more questions or comments.

MOTION: Commissioner Nilson moves to approve LVT031120: Request for final approval of Taylor Landing Cluster Subdivision Phase 1A, consisting of 28 lots in the A-1 Zone, located at approximately 4000 W 2200 S, Ogden UT, and 3 LVT031120: Request for final approval of Taylor Landing Cluster Subdivision Phase 2, consisting of 20 lots in the A-1 Zone, located at approximately 4000 W 2200 S, Ogden UT. This recommendation for approval is subject to all review agency requirements and based on the following conditions: 1. An HOA shall be established and properly registered with the State of Utah. Associated Covenants, Conditions and Restrictions (CC&R's) shall be reviewed and approved prior to being recorded simultaneously with the final mylars. 2. Per LUC 108-3-5(f)(3), an agreement shall be recorded with the final plats to the title of all open space preservation parcels that details the open space preservation plan and any conditions necessary to execute the open space preservation plan. 3. The small open-space parcel containing the required sewer lift station shall be deeded over to the County simultaneously with the recording of the final plat. 4.

Final letters of approval shall be submitted from Taylor West Weber Water, Hooper Irrigation Company, and the Central Weber Sewer Improvement District prior to recording the final plat. 5. Approved subdivision improvements shall be installed, or an escrow established for their installation prior to recording the final plat. 6. Property taxes that are currently due for 2020 shall be paid in full prior to recording any final plats. This recommendation is based on the following findings: 1. the proposed subdivision conforms to the Western Weber General Plan. 2. The proposed subdivision complies with applicable County ordinances. Commissioner Andreotti seconds. Commissioner Wichern, Votes aye. Commissioner McCormick votes aye. Commissioner Bell votes no. Commissioner Favero states that he would like to make a statement that he is not involved in any venture with Tom Favero and vote aye. Commissioner Nilson votes, aye. Commissioner Andreotti votes, aye. Chair Edwards, votes aye. Motion carries (6-1).

ZTA 2020-05: Public hearing to discuss and take comment on potential scenarios to amend § 108-7-25 of the Weber County Code regarding short-term rentals.

Scott Perkes notes this presentation was given to the Ogden Valley Planning Commissioner on October 27th for a discussion on a couple of scenarios for potential short term rental regulation. In addition to the draft ordinance that would accompany some of the scenarios. He notes that they wanted to bring it to the Western Weber Planning Commission as well. Any potential ordinance would be Countywide and could potentially affect Western Weber. He adds that they will want to have a public hearing and see if there are any comments from the public in Western Weber on this issue.

Mr. Perkes gives an overview of the public comments that he has received to date. He notes that the numbers will be updated before the issue goes to County Commission. The number one concern is community character. There were some concerns about noise and code enforcement, parking, safety, traffic, HOA's, Law enforcement, tax revenue. There are arguments in favor and against some of these topics. For Example, people are concerned that people aren't paying their taxes. They are frustrated that those taxes aren't being collected. Concerning property right there are concerns that it will go up or down. There are people on both sides of the fence concerning this issue. They are concerned with trash and large occupancy, infrastructure, and thing of this nature. He notes that these are some of the issues that have been worked on as a part of the ordinance. He asks how to address this because short term rentals are happening. They are happening in areas where they are allowed but they are also happening quite frequently in areas where they are not allowed. These issues need to be addressed through regulation. He asks if there are any questions or comments on this.

Mr. Perkes states there is a full draft of the ordinance in addition to the scenarios and more information is available on the Frontier website <https://frontier.co.weber.ut.us/p/Project/Index/10593#documents>.

Mr. Perkes gives an overview of the operational requirements. He notes that the short term rentals are not allowed in accessory buildings, accessory dwelling units, and deed-restricted housing. He notes that no matter where they are in the County they do not want short-term rentals to encroach on those uses. A license would need to be secured by property owners before operating a short term rental in an allowed area, they would be responsible to collect their taxes and remit those taxes as well. There are some requirements for operational standards some requirements for them to disseminate information to the public and the potential renters and have advertising requirements so that they could only advertise their property per their approval and they can't be advertising the property for large occupancies or more parking than their property can handle. It will need to be advertised appropriately. There would be occupancy limits, parking requirements, noise limits, trash disposal, and collection requirements. The outdoor light would need to comply with the Ogden Valley Outdoor Lighting requirements. Signage and advertising would not be allowed on the property. They will need to meet fire safety. In a future scenario if they were to adopt a more robust short-term rental regulation all of these items would be associated with any short-term rental that is operating. These are labeled in a lot more detail in the full ordinance. It goes into full detail on what is allowed under the parking requirements and what is allowed under the occupancy.

Mr. Perkes goes through regulatory scenarios. He notes that the Ogden Valley Planning Commission preferred the proof of concept. He notes that it was not included in the packet.

Mr. Perkes states that concerning the 3rd party enforcements, scrape all major and many minor STR sites to identify unique listings and their specific addresses. It allows for efficient licensing, tracking, and renewals. It consistently monitors listings for compliance with the County STRs ordinance and licensing requirements. It consistently monitors rental activity and collects data to be used for enforcement efforts. They have dedicated hotlines staffed 24/7 for neighbors to report non-emergency STR complaints, submit evidence, and initiate automatic follow-ups.

Commissioner Nilson asks if the Ogden Valley Planning Commission has approved this. Mr. Perkes states that they have not. They tabled it for their meeting on the 17th. They wanted a more clearly defined proof of concept scenario. He notes that he has included this into the presentation it is business as usual but they would be adding the proof of concept would look like. It is business as usual but they would be adding the third party enforcement capability and enact the ordinance that would have the operational licensing standards with a tougher fine and violation structure.

Commissioner Wichern states that she likes the direction Ogden Valley is going, there is a concern that there won't be areas in Western Weber with rental capabilities, but there is a housing crisis and they need the ADU's and if they allow the short term rentals it might take away from ADU availabilities. She states that she believes that the ADU's will be considered equally lucrative given Western Weber's distance from the recreation area.

Commissioner Favero asks what the preferred scenarios was. Mr. Perkes states that it was the proof of concept scenario. He notes that under this scenario they would not be changing where short-term rentals are allowed, but they would enact the ordinance with the operational standards and the licensing requirements, stricter penalties, and violation structure. Under the proof of concept, they would put into place some of the tools. Commissioner Favero notes that the proof of concept was not included in the meeting packet. Mr. Perkes states that the ordinance has been updated in Frontier with the full proof of concept.

Commissioner Wichern asks if Ogden Valley has approved this yet. Mr. Perkes states that it was tabled, so that staff could put together a clearer scenario. It will be back before them on the 17th of November. Commissioner Wichern asks if they should wait for Ogden Valley to make a recommendation. Mr. Perkes states that they can.

Chair Edwards states that if the Planning Commissioners don't have any more questions, they will need a motion to open the public hearing.

MOTION: Commissioner Nilson moves to open the public hearing. Commissioner Favero seconds. Motion carries (7-0)

Jan Fullmer 3741 Red Hawk circle Eden, states that she lives in the large unincorporated area of Ogden Valley. She states that a great deal of effort and kudos goes to Scott Perkes. He has had to put together a lot of information. She states that the majority of people who have submitted comments and concerns in the Ogden Valley are totally against any expansion of short term rentals beyond the zoned areas in which they are allowed. It is not consistent with the Ogden Valley General Plan which took two years to develop. There are some property rights issues. Some people intentionally purchased homes or built homes in zones that do not allow short term rentals. They could have picked a home in an area that allowed short term rentals. Some people have purchase home in zones where short term rentals are not allowed to rent but did not know it was not allowed in their area. They indicated they want the allowed areas expanded because this is a source of income for them. They did not look at the zoning before they made the purchases. Some of the people are not even residents of Weber County or residents of Utah. They are located out of state and are looking to buy property as a source of income. She states that they have also finished a study 867 units can be legitimately rented for short term rentals. Of these units, 32 single rooms are part of bed and breakfast the rest of them are either condos, townhomes, or single-family homes in zones that allow short term rentals. They are comprised of one to six bedrooms. The majority of those are on the valley floor. She thanks the Western Weber Planning Commission for waiting to hear from the Ogden Valley Planning Commission. She adds that the people in Ogden Valley are very upset about this, and looking at the scenarios that would expand short term rentals and the fact that the majority of people are totally against it. She adds that they were told that it is not a democratic process and they were very discouraged by this. There are some really big issues in the Ogden Valley.

Chair Edwards asks if there are more comments. There are none.

MOTION: Commissioner Bell moves to close the public hearing. Commissioner Wichern seconds. Motion carries (7-0).

MOTION: Commissioner Wichern moves to table ZTA 2020-05: Public hearing to discuss and take comment on potential scenarios to amend § 108-7-25 of the Weber County Code regarding short-term rentals until the next meeting. Commissioner Bell seconds. Motion carries (7-0).

ZTA- 2020-03: Public Hearing to discuss and take action on a proposal to amend the zoning code to allow for accessory dwelling units in all single-family dwellings as a permitted use.

Director Grover states that this is another item that was instigated by staff. The reason for this is to meet the affordable housing requirement. He notes that they are required to give an update on affordable housing by December 1st. They will want to open and close the public hearing.

Tammy Aydelotte states that this is a staff-driven request to amend the current land use ordinance to allow for accessory dwelling units as a permitted use in any zone that allows for single-family dwellings. The main purpose is for the County to be able to allow for housing types that might accommodate the various needs that may exist and continue to exist in Weber County. She notes that they are looking at projected growth in Weber County alone of almost a 50 percent growth in population just in the next 15 years. They are looking at a population of 380,000 by 2040. They need to make sure they are allowing for the different housing types that are going to come up. The statistics that they looked at were retirement age. These are the younger population that can typically be categorized as somewhat dependent on the core of the working force. The thing to know with the amendment, this allows for accessory apartments as a conditional use. Accessory apartments are allowed almost anywhere single-family dwellings are allowed as long as the property owner applies for a conditional use permit. She notes that they are looking to remove accessory apartments altogether and replace them with accessory dwelling units which would be allowed as a permitted use. They would not have to apply for a conditional use permit, they would apply for a land-use permit. This is much less exhaustive. She adds that they have taken comments from the Planning Commission during worksession. She goes over the changes made from the last work sessions.

Ms. Aydelotte states that under the General Provisions one accessory dwelling per lot would be allowed. An accessory dwelling unit in addition to the main dwelling. An accessory dwelling unit would be subordinate in size and height to the main dwelling that it would appear similar in size and style or would appear as a historical or an agricultural building. Under this provision, short term rentals will not be allowed. The owner must occupy either the main dwelling or the accessory dwelling unit. These applications would need to go through the appropriate review agencies. Specifically water and sewer. She notes that they would require an approval letter from each of those stating that the existing infrastructure has the capacity for an additional dwelling unit that they would allow for some additional infrastructure to be able to accommodate that.

Ms. Aydelotte gives an overview of some of the other changes made from previous meetings. She notes that if an accessory dwelling unit is rented, a business license is required. The Code Enforcement Officer Iris Hennon will be very involved in the process. The business license will be issued after all other approvals for the dwelling unit has been granted.

Ms. Aydelotte asks if there are any questions for her.

Commissioner Wichern states that she had some concerns about 108-19-4(B). She notes that she wants to have restrictions but she does not want to have too many restrictions. She states that there is a possibility that a barn out west could be used as an accessory dwelling unit the barn may be in front of a house or to the side. She states that she is nervous about the height requirements for lots greater than 20,000 sq. ft. In Uintah Highland, some very large lots could have accessory dwelling units that exceeded 1500 sq. ft. without causing an eyesore. That could exceed the height of 25 ft. without looking out of place. She states that this is her main concern. If they expand the limitations when they get above 20,000 sq. ft. because there will probably be more options for larger lots. Ms. Aydelotte states there was a scenario discussed possibly grandfathering some of the buildings. Mr. Ewert states that it was

a stopgap. They wanted to put this in place and if they find that there were a lot of people going in with an existing building then might be able to go in and stitch up the code a little differently at that time. Looking at 108-19-4 (B) (3) “the leader line states that for a lot that has 20,000 sq. ft. or less and has the additional restrictions”. If there is a larger lot anything out West these standards won’t apply because they are supposed to be 1 acre lots. He notes that as Commissioner Wichern stated this is about big lots vs small lots. He asks if they should say anywhere it is less than 20,000 sq. ft. those are the restrictions. They won’t have the 90 percent height restrictions or the 25 percent total lot area. This however does not solve the concern about the 1500 sq. ft. total. Looking at how it is rewritten, previously it was gross floor area and it said 1500 sq. ft. currently it says footprint and essentially as viewed from a birds-eye view. If they could draw a perimeter of the footprint of that building that would be 1500. If there is a basement and a two-story home and the footprint is 1500 sq. ft. this is a substantially sized home in those cases. He asks if this solves the issue. Commissioner Wichern states that it doesn’t. It says that if the ADU’s don’t take up the entire accessory building and if it is just a portion of it the entire building has to meet these criteria. They could just be using the loft of a barn a 1500 sq. ft. footprint barn and this is quite small. She states that in Uintah Highland there are carriage houses that would exceed the 1500 sq. ft. 25 percent of the total lot area might be a better restriction. She states that she is concerned about the 25 ft. and 1500 is more restrictive than what they have comparatively for their lot at the 20,000. Mr. Ewert states that what he is hearing is that there may be some large barns but only a portion of them used for accessory dwelling units. Commissioner Wichern states that this part of the concern. Mr. Ewert states that looking at (B)(1) the intent of the way it is written is not to look at the entire building but to look at the footprint of the accessory dwelling unit only. It was specifically written that way so that they could state what portion of the barn is the accessory dwelling unit and the rest of the barn is used for equipment or animals. He notes that they will only be looking at the portion that has the accessory dwelling unit. It got confusing when applying it to multiple stories. They can draw a perimeter around the exterior of all floors and that is the footprint and not consider the greater building at that point. Commissioner Wichern states that she would like to change the height to 35 ft. it refers to the height of a detached building that houses an accessory dwelling unit. She states that she is concerned about this. There is a restriction for the smaller lots, for the bigger lots she doesn’t want to block people. Mr. Ewert states that if they change this to 35ft. in part 2 it would not negate part 3. It could state no greater than 35 ft. in part 2 and on a lot that is 20,000 sq. ft. or less you still can’t be higher than the height of the main dwelling. Commissioner Wichern states that she would also bump the 40 percent up to 50 percent, they are going to have other footprint requirements to meet, and then they don’t have to worry about it unless it is in the basement.

Chair Edwards asks if there are any other comments.

MOTION: Commissioner Bell moves to open the public hearing. Commissioner Wichern seconds. Motion carries (7-0).

There are no public comments.

MOTION: Commissioner Bell moves to close the public hearing. Commissioner Wichern seconds. Motion carries (7-0).

MOTION: Commissioner Bell moves to forward a positive recommendation to the County Commission on ZTA 2020-03 Public Hearing to discuss and take action on a proposal to amend the zoning code to allow for accessory dwelling units in all single-family dwellings as a permitted use. With the added changes concerning section 108-19-4 concerning (B) (1) change the 40 percent to 50 percent and end the sentence after of the gross floor area of the main dwelling. On Part 2 change the 25 to 35. This recommendation is based on the findings that 1. The changes are supported by and are part of the execution of, the 2003 West Central Weber General Plan. 2. The changes are necessary to address the growing need for various housing types in Weber County. 3. The changes will enhance the general health and welfare of County residents. Commissioner McCormick seconds. Motion carries (7-0)

ZTA 2019-06: A public hearing to consider and take action on ZTA 2019-06, a request to amend the Weber County Land Use Code to create standards for storage units in the commercial zones.

Charlie Ewert states that as they looked at the change of storage units adding the use in and adding standard for and comparing the differences the zones are almost the same zones in terms of the chapter. The chapter read almost the same way in Western Weber

and the Ogden Valley. When the zones were made for the Ogden Valley they copied and pasted for the C-1 and C-2 zone in Western Weber and filtered out a few of the uses and applied it to the Ogden Valley. Since there have been so many changes to the Ogden Valley's commercial zoning because there have been commercial developments happening in the Ogden Valley and now there are discrepancies between the two chapters if there is a use that is listed in a zone in the Ogden Valley but it is not listed in a zone out West. The code states that if it's not listed it's not allowed. It is strange when there are different nuances of the same use but it is very specifically called out in one portion and not the other. The very specific call-out could lead to some believing it's not allowed if it's not listed in the other section. He states that the code is plenary. His proposal is to take the opportunity and take the CV-1 and the CV-2 zones of the Ogden Valley back into the same chapter as the C-1, C-2 and C-3 zones. If this is not done the possibility of interpretive error because of the discrepancies justifies the reasons to stitch them together. He adds that they can easily make mistakes in interpretations that could easily be appealed if it ran up the appeal chain. He states that his suggestion is to compare apples to apples and make it very clear on the use table what is allowed and where. The subject of the proposed text amendment and a minor subject is outdoor storage. Concerning storage units, the idea is that some village areas have been proposed in the General Plans and they are intended to be pedestrian activity-oriented. When there is development in these areas they are hoping to see big sidewalks with storefronts that are at the street level and parking in the rear. He states that they are quite a bit ahead on their development of those design standards in the Ogden Valley that shows the design standards for the streets. He notes that they are not that far ahead in Western Weber. They will catch up quickly when they start working on the General Plan. If they want to have a pedestrian-oriented experience there is nothing that is going to kill it faster than having a wall of useless space the space is not useful to the pedestrian. It is unlikely that they will have a pedestrian walking to their storage unit and the use itself tended to be a vibrant village. They can however add space in the village for it as long as it is not taking up space that is on the street front, this is space that they want to reserve on the street level retail operation or other commercial operations. The standards push the storage to the second level or the area that is behind the street front or street-oriented commercial space, behind could be in the same building or behind the units that are commercial or it could be in another unit that is behind that building that is on the street front. The concern from the storage unit developer is that this is going to increase the cost of developing storage units. A simple answer to them is that storage units are still allowed without these kinds of standards in the M-1, M-2, and M-3 and the Ogden Valley MV-1 zones. It doesn't eliminate their ability to locate in the area, it just doesn't allow their ability to locate in the village area without the street front standards. The other thing that he is doing is writing a definition of outdoor storage and writing that use in the M-2 and M-3 zones. In the proposal, it states that in the M-2, the M-3 zone is not going to be there that is because in the M-3 zone one of the first things it says that is allowed is anything in the M-2 zone.

MOTION: Commissioner Nilson moves to open the public hearing. Commissioner Andreotti seconds. Motion carries (7-0)

There is no public comment.

MOTION: Commissioner Andreotti moves to close the public hearing. Commissioner Favero seconds. Motion carries (7-0).

MOTION: Commissioner Nilson moves to forward a positive recommendation on the County Commission for file ZTA 2019-06, the addition of development and architectural standards for indoor storage unit facilities and other related clerical edits. 1. Both the West Central Weber General Plan and the Ogden Valley General Plan call for commercial design standards in village areas. 2. The regulations will protect villages from the poor aesthetics that are typical of storage unit facilities, and thereby supporting the potential vitality of village areas. 3. That the clerical edits offered will assist with a more organized, efficient, and accurate administration of the zoning ordinances. 4. That the proposal is not detrimental to the health, safety, and welfare of the public. Commissioner McCormick seconds. Motion carries (7-0).

ZTA 2020-07: A public hearing to consider and take action on ZTA 2020-07, a request to amend the Weber County Land Use Code to add a height limit for weeds and turf grasses.

Charlie Ewert states that two points are added to this. If there are weeds or non-ornamental grasses they need to be maintained at a level of no greater than six inches. If the Planning Commission wants to go higher or lower this can be discussed. It also places the responsibility of weed and other vegetation control and a public right of way that adjoins a property owner's property. It places the

responsibility on the property owner. When it comes to shoveling snow on a sidewalk and there is vegetation that goes right up to the shoulder all of the vegetation is the responsibility of the landowner.

Commissioner Andreotti asks if the area in Western Weber County between the pavement and the drain ditch will apply. Mr. Ewert states that it will and that is one of the areas that the County Commission was targeting and they want to make it very clear that it is the landowner's responsibility to keep those weeds down. Commissioner Andreotti states that a person from the County comes down once or twice a year and they mows about 3 ft. from and the other 6 ft. can have weeds. He states that he doesn't like the idea of clearing the weeds for the County. He adds that if he has to do it he will but not everyone in Warren has a weed whacker. Private citizens should not be whacking the weeds off of the County's right of way. Director Grover states that this is something that if they choose to leave that portion out of it, it would just stay as it is and it would just be required for the private property. He adds that they want to allow that the weeds be a little higher in the public right of way they can do that also. He states that the standards are not set in stone and the County Commission would like their recommendation on this. What brought this about was that they went out with the County Commissioners and the Noxious Weed Board and there was a concern because of the thistle, phragmites, and the puncture weeds that are spreading rampant throughout the area and some of the farmer are not maintaining it. He notes that most of the farmers are taking care of it. There is an area where they are not being taken care of and the noxious weeds are spreading. Subdivision where they have gotten approval and they are not keeping the weeds down until it is developed. These are big concerns that were seen by the County Leadership when they went out on a site visit. They were asked to visit to reduce the visual impact that these have on the residents. Commissioner Andreotti states that he agrees 100 percent with the private properties because he was there on the weed day and it is embarrassing. He states that he is okay with that and the 6-inch height because if they are going to spray them it is easier to spray them at 6 inches. The only issue he has is having to cut the weeds on the County's right of ways. Mr. Ewert states that the other option is to expand the County's capability to knock the weeds down. This does however have a big cost associated, this is why they are hoping to rely on the adjoining landowners to do it. Commissioner Andreotti states that he like having a nice-looking community, but it is also on the local government, and the local landowners to do some of that but there is a line there. Chair Edwards states that the weeds in the ditches sometimes grow taller than the weeds on the side of the road. The landowner may not have the ability to clear the weeds in the ditches. It should be the County's responsibility. He states that it is a safety concern and there are liability concerns. He states that he does not agree with that section as well. Commissioner McCormick states that there is too much frontage for the people to take care of those weeds and where the storm drains it is almost impossible.

Commissioner Wichern states that speaking from the perspective of someone is not from the agricultural area. She states that they spend a lot of money on the homes in her area and even though it is not her land the County has allowed her to take care of it and present it the way she wants to. She states that the biggest issue is concerning the ditches is safety. She asks if the people in Uintah should have to subsidize someone else responsibility. If there is a concern with safety that needs to be considered. Director Grover states that they could put language in the code that requires the weed height to be maintained right of ways where improvements have been fully installed this means curb water and sidewalk. Where the improvements have not been required, this is typically along with farm areas and agriculture, the County will remain silent. Mr. Ewert states that there is another point in favor of this if they have the weed whacker and they are standing on the edge of pavement some of the roads are narrow enough that the passing vehicles are close enough. There are some serious safety concerns. He states that he can revamp it and bring it back with suggestions for curb water and sidewalk. He asks if they should just do curb and gutter. All Planning Commissioner agree that they support this.

Commissioner Bell states that he likes the change but he has a concern because of the number of developments that have been deferred with curb and gutter. It should still apply to them. He asks if there is anything else that they can add. If they don't have curb and gutter they are still responsible. He adds that he does feel that it is ridiculous to have the farmers on the edge of 12th St., it is not reasonable. Chair Edwards agrees and states that most people are going to do what they can in front of their homes to get the weeds down. He adds that the problem is in the agricultural fields that have big drain ditches. In areas such as 1800 S and 3300 S there, this is the shoulder of the road and there might be a foot or more weeds and then there is a drainage ditch. He states that his main concern is maintaining those areas.

Mr. Ewert states that based on the design shred that was done a year and a half ago for the General Plan, the people in the area don't want to see curb and gutter they want to see the Country lifestyle and a part of that is the drainage ditch. There might not be someone to maintain the ditch areas if they don't require the curb gutter and sidewalk unless a regulation gets adopted that says someone has to maintain that. Commissioner Bell states there are a lot of places in the area that don't have curb gutter and sidewalk but are still very residential, there is no reason they should be held accountable for the weed control.

Director Grover states that they may want to put language in the code that states that in areas where there are right of ways that have been fully improved or they have issued deferral agreements, they are required to maintain their weeds but in all the other area, the County will remain silent, this way the farmers are protected. Mr. Ewert agrees and states that will have to see how it applies they move to a standard. They might need to modify it at that point.

MOTION: Commissioner Andreotti moves to open the public hearing. Commissioner Favero seconds. Motion carries (7-0).

Chair Edwards asks if there are any comments from the public. There is no public comment.

MOTION: Commissioner Nilson moves to close the public hearing. Commissioner Andreotti seconds. Motion carries (7-0).

MOTION: Commissioner Nilson moves to forwards a positive recommendation to the County Commission for file ZTA 2020-07, the addition of a weed height regulation, based on the following standards: Staff Report to the Western Weber and Ogden Valley Planning Commission Weber County Planning Division Planning Commission Staff Report -- Weed Height Regulation Ordinance Page 1 of 4 1. Both the West Central Weber General Plan and the Ogden Valley General Plan support a community that is aesthetically pleasant. 2. That the clerical edits offered will assist with a more organized, efficient, and accurate administration of the zoning ordinance. 3. That the proposal is not detrimental to the health, safety, and welfare of the public. With the added condition that section 108-7-6 (a) applies to developments with curb and gutter or the County holds a deferral agreement for the development. Commissioner McCormick seconds. Motion carries (7-0).

ZTA 2020-04: Consideration and action on a request to amend Weber County Code to enable development along substandard streets under specific conditions.

Mr. Ewert states that there was a discussion on this before and it was tabled pending some changes to a portion of what was in the proposal that pertained to public utility easements specifically to address drainage and tailwater on agricultural property. He notes that this change is still ongoing. Mr. Ewert apologizes to Commissioner Andreotti and Commissioner Favero because they have been invited to join a small committee with some guys from the Roads Department and the Engineering Department to get together and discuss these issues from the agricultural perspective. He has not been able to get everyone's schedule together. It should not need more than a couple of meetings to make sure everyone is on the same page on how public utility easements and drainage can and will work. The County Commission wanted to address the substandard roads. He states that he decided to add the public utility easement modifications into the proposal because he thought it was a fairly simple thing. He states that now that they have seen that it is not simple he would like to separate them. The County Commission wants to find a way to allow development to occur on a substandard road and make sure that the safety factors for that road are being accommodated.

Commissioner Nilson states they have already heard of all the growth the County is going to receive, and it is going to happen on that type of road. It is a double-edged sword. Having been a developer improve half of a mile of road to get to the property, is unlikely. This would dead-end development. He asks who could afford to do it unless they bought their property for a small amount of money. He notes that Mr. Ewert has tied it together really well that it has to be the responsibility of the developer at some point but not to do it all.

Commissioner Bell states that he has a bit of a concern a lot of the substandard roads could exist at the end of the roads and they could start seeing developments and they are not going to be small developments. Part of the concern is that they are going to out

the burden of doing those homes on one or two landowners to make sure that a hundred homes can go in. He states that the way forwards and what has been discussed is helpful and he is not sure of the solution. He states that a hundred homes going in should pay for the improvement in front of the two existing landowners. Mr. Ewert states that there is more to it. He states that what they are asking the developer to do is to improve the unsafe parts of the road. It would be on the developer. They would also be asking them to contract every resulting landowner inside his subdivision to not file protests if the County comes in and tries to create a special assessment area. By virtue of buying the property, they are agreeing to a special assessment area when the County decides to apply it for the purpose of applying the road. He states that Commissioner Bell is asking about the people who live on that road already and asking if they are going to be brought into the special assessment area. The answer to this question is that it depends, every road is going to be a unique situation. It depends on what is missing and where it is missing, and long term factors of safety as development continue, but this is why in the last paragraph, there is a section on roughly proportionate. The developer needs to contract for a deferral agreement that is roughly proportionate or improvements into the existing street system that is roughly proportionate to their impact. In determining rough proportionality they need to look at questions of minimal lot width of the applicable zone, actual lot width, and average daily distance traveled. The use of a lot. The weight of a typical vehicle is related to the use. This also includes daily trips. The total number of daily trips. The longevity of the current ownership. The longevity of existing development or uses as they relate to historical property taxes made and any other consideration deemed necessary. He adds that this will only apply to the developer. It is written in a way that is meant to explain what rough proportionality is supposed to be. If the County Commission did create a special improvement district, to pay for improvements on that roadway. There is increasing traffic over time. The County Commission would have to determine who is in the special assessment area or the special improvement district. He notes that an important factor in helping with the determination is how long the homes have been there and what came first, at what point the improvements were added. Commissioner Bell asks if there is a way to make it so that owners who have been there a long time and have already paid for their impacts never have to be included in the deferral agreement. Mr. Ewert states that those landowners outside of the new development that was required to sign the agreement, will have full rights and responsibility if it is their choice to protest the creation of a special assessment area as it relates to their property. They could protest as it relates to anyone's property but especially theirs. They all have the right to go to the County Commission and advocate as to why they shouldn't be included at that time.

Commissioner Wichern states that she has some concerns. She states that she is not comfortable with this adjustment to the code. Although it might be prohibited for developers to develop land that is too far out because of the restrictions, she feels that it is best to let the roads grow organically, so that there will be a balance between the cost of the land and the cost of the improvements to get to the land manage the growth so that they are not growing so far out that they are putting a burden on the County and the school system, and public services. Weber County has to service them and the farther out they are the more expensive it becomes. She states that her other concern is that once a problem with road systems has been established it is years before the problem gets addressed. In this situation, the benefits may not outweigh the cost. The County and its residents will be paying more for the street than the developer would have at the beginning. It would be better to keep it the way it is and have the developer decide from the beginning if the land is a good purchase. She states that if the tax base cannot support the growth she cannot see this as advantageous. Mr. Ewert states he appreciates Commissioner Wichern's understanding and context on the sprawl.

Commissioner McCormick asks what will happen if there is leapfrogging and some areas get developed nicely and other portions are not. What is going to happen when the roads in the area are 20 to 30 ft. wide and the requirement is 36 ft. is the County going to use eminent domain. If so this is not what eminent domain was set up for, to help a developer. Mr. Ewert states that there will be occasions concerning leapfrogging where some areas will be developed and other spots where it will just look like a sea of asphalt because it was built to full improvements anticipating future growth. The County will have to assess the risk of the spots that are not built to full improvements. Commissioner McCormick asks if this would be done through eminent domain. Mr. Ewert states that it would if they needed to, as they did on 3500 W when that was expanded. For most people, they had to buy between 7 and 10 ft. of their front yards. He notes that for the most part, they stayed out of the eminent domain on 3500. Commissioner McCormick states that they should look at what could happen, it should be based on the health welfare, and safety of the County. He states that he does not see how that applies.

Mr. Ewert states that the Planning Commissioners can move forward with a negative recommendation concerning this item for the reasons mentioned. He notes that he could rewrite part H. and not have any subparagraphs. They could recommend denial of the

proposal and recommend approval of just what they see. Commissioner McCormick asks what the suggested size of the road is. Mr. Ewert states that it is a 66 ft. right of way. The County Engineers are leaning towards 36 ft. of asphalt. Commissioner McCormick asks if this is accomplished through eminent domain. Mr. Ewert states that the purpose of the paragraph is for the developer to do it that way. If someone else already owns the property the developer cannot use eminent domain on them. The developer would need to try and convince the County to do that themselves. He notes that he cannot say what would happen, it depends on the politics of the time.

Commissioner Bell states that he is not comfortable letting the cost land on existing landowners in any situation especially if there is an option for eminent domain to help promote development at the cost of a landowner.

Commissioner Wichern states that her other concern is that they may end up with substandard streets for a long time. She states that she doesn't believe that the rate at which Utah is growing is going to outpace any kind of eminent domain or special assessment. Those are very slow-moving organisms and they are setting themselves up for safety issues in waiting to improve those streets.

Commissioner Bell states that he does not like the idea of putting the burden on the existing landowner, but somehow there has to be an updated road without putting an undue burden on the developer.

Chair Edwards suggests that they have a work session with the County Commission to get their input. Mr. Ewert states that this would be a worthwhile thing. Commissioner Nilson agrees and states that this is incredibly important.

Commissioner Wichern states that they could not ask the developer to not put in all the improvements but to acquire the land and make sure that the land is available. The burden of cost, the road improvements, and the public works be acquiring the land if there is a bottleneck somewhere. This might help expedite the road process in the future. She states that they would want to prevent development that would require eminent domain from being used. Mr. Ewert asks what would occur if there were someone unwilling sellers. Would that mean keep the selling price? Or have the price going up more and more. Commissioner Bell states that the landowner has the right to refuse to give up his property. It makes it hard for the developer, but the developer can sell his land for a lot more or sell his development for a lot more if he can make the improvements. If he can't then he is restricted on what he can do with his land. There are some land rights issues that are affected there, he can get held hostage by one landowner. There is no easy way to resolve that. Both of them have a certain right, one should not have to give up their rights to support another.

MOTION: Commissioner Bell moves to table item ZTA 2020-04: Consideration and action on a request to amend Weber County Code to enable development along substandard streets under specific conditions. To hold some work sessions with the County Commission. Commissioner McCormick seconds. Motion carries (7-0).

Remarks from Planning Commissioners:

Commissioner Andreotti states that he feels bad about being on the Planning Commission tonight. Concerning the Taylor Landing Subdivision, there are two sides, and the Planning Commission tries to make the best decisions they can with the information that they have. Cluster subdivisions were created to save open space. This has created a problem because tonight there was a citizen's name dragged out right in front of everybody and one of the Planning Commissioners. He states that this not mob rule, this is a professional forum whether there are disagreements or not, they should not be taken up in this forum. He states that he feels that they looked like a bunch of fools concerning that issue. He states that they should get rid of the A in the zoning and turn it into an R. the agriculture should move out. It is not worth the cost. He states that it is not right to have mud slung at the Planning Commissioners. There is too much emotion attached to it. It has been the same thing for the last four years. A zoning change would be appropriate.

Commissioner Bell states that he was completely prepared to approve Taylor Landing. The change that was made was too significant. He states that he does not understand why the Fire Marshall would approve it. It is possible that the developer could only get through a few phases and they would up with 60+ homes on a single egress. He states that this was approved tonight and

that bothers him. He still feels that it does not meet the cluster code, but the County Commission decided that it did. The change that was made created a safety hazard. His kids play on that road. He might be too close to this issue and the other Planning Commissioners can vote him out if they want the next time it comes up.

Commissioner Bell asks what the County's plan is to move forward with the General Plan. He agrees with Commissioner Andreotti that they need to start putting in R-zones and developing a General Plan that can be maintained and adhered to. What is currently available does not meet what is going on in the area. He states that this is a big issue and it is going to require a lot of public input.

Commissioner Bell notes that the reason that he wanted to move the public comment to the beginning of the meeting was that he has received feedback from the public that they feel that they can't attend the meetings or that it is not worth their time. He states that he wants to find a way to allow for more public input and maybe move the public hearings closer to the front so that people present for public hearings can participate instead of waiting until 8:30 at night to be heard. He states that they should do what they can to solicit more participation from the public.

Planning Director Report:

Director Grover states that he appreciates Commissioner Bell's comments about moving the public comments section forward, this is something that they can look at.

Director Grover states that they are very concerned about preserving the Planning Commissioner's good names. Before the meeting, they knew that there were two individuals that there might be some concerns about, because of what happened at some previous meetings. The Attorney's office reached out to Commissioner Bell and spoke to him about a conflict of interest. He reached out to Commissioner Favero and spoke to him. This was already brought up in a previous meeting and it was already determined that there was no conflict of interest which is why this was not brought up. Concerning Commissioner Bell it was left up to his discretion on whether he should bring it up, which he did. He states that they always want to preserve their good names and if they see things that could be a conflict of interest they will reach out to the administration. He states that they are very concerned about preserving their good name and the integrity of the Planning Commission.

Director Grover states that they serve Weber County and the Election has left Western Weber in Weber County. The County Commissioners have agreed to put out an RFP for the General Plan. For the last 3 years, they have carried over the funds. They have devoted 50,000 dollars. He notes that he is taking 20,000 dollars out of his budget. Staff time will also be devoted to this. He states that they will be working on putting an RFP out together and put out for the General Plan. He adds that they are hoping to have the General Plan started as soon as possible. The County Commissioners are fully behind it. He adds that they will not only be doing Western Weber but Uintah Highlands as well. Both of those areas will be part of this. This will be a six to seven-month process. One of the major concerns is getting public comment during COVID and making sure that everyone's voices are heard. There will be different focus groups and a Planning Commissioner assigned to each of them. There will be members of the County Commission assigned to different items. The various focus groups will come back with the Planning Commission. He states that they are trying to decide how to do it. He adds that they want to move forward with this as soon as possible but they will also have to put a lot of things on hold to accommodate for this. The focus will be wholeheartedly on this.

Commissioner Bell states that there is going to be a lot of work for the Planning Commission. He asks if it would help if they meet more often. Director Grover states that there will be more meetings. They will put together an agenda with timing and it will be presented to the Planning Commission to see what is doable. He states that he has worked on many General Plans but he has never had to deal with COVID and doing it via Zoom. He states that he wants to make sure that it is an open and transparent process. The Planning office takes great pride in being transparent. He states that they will need some collaborations to make sure that when it is presented it is clear and concise. Commissioner Bell asks if they are going to be able to hold in-person meetings if they take extra precautions. Director Grover states that it is an option. One of the things they will be looking at is having larger venues. Mr. Ewert adds they can also take advantage of technology. They could put together video presentations and the PR people to come with some animations. UDOT has published a web map. When they click on an area they can comment. Director Grover states that to a certain extent he likes Zoom because it makes it more accessible, but there is nothing like in person. It is going to be challenging but it might be a better product.

Remarks from Legal Counsel: Mr. Wilson thanks Commissioner Bell and those who are wondering about a conflict of interest it is not just limited to a financial interest. There are also apparent conflicts of interest. He adds that the main goal is to make sure that the Planning Commissioners are safe and keeping from being liable. This is why the Attorney's office has determined that transparency is the best way to go through it. Taking a vote does take longer, but it is important to get it out there to make sure that people are aware. He adds that he is happy to discuss this with anyone at any time.

MOTION: Commissioner Bell moves to adjourn. Commissioner Wichern Seconds. Motion carries (7-0).

Adjournment: 8:40 PM

Respectfully Submitted,

Marta Borchert

DRAFT



Staff Report to the Western Weber Planning Commission

Weber County Planning Division

Synopsis

Application Information

Application Request:	Consideration and action on a conditional use permit application for Christensen Fabrication Shop, a fabrication shop making parts for the airline, mining, and construction industries.
Type of Decision:	Administrative
Agenda Date:	Tuesday, December 8, 2020
Applicant:	Nathan Christensen, and John Bowen
File Number:	CUP# 2020-19

Property Information

Approximate Address:	8052 W 900 S, Ogden
Project Area:	10.44 acres
Zoning:	M-1
Existing Land Use:	Vacant Manufacturing
Proposed Land Use:	Fabrication shop
Parcel ID:	10-174-0001
Township, Range, Section:	Township 6 North, Range 3 West, Section 15, Southwest Quarter

Adjacent Land Use

North:	Vacant	South:	Residential
East:	Vacant	West:	Vacant

Staff Information

Report Presenter:	Felix Lleverino flleverino@co.weber.ut.us 801-399-8767
Report Reviewer:	SB

Applicable Ordinances

- Title 101, Chapter 1, General Provisions, Section 7, Definitions
- Title 104, Chapter 22 Manufacturing Zone (M-1)
- Title 108, Chapter 1 Design Review
- Title 108, Chapter 4 Conditional Uses

Summary and Background

The applicant is requesting approval of a conditional use permit for a fabrication shop that will make parts for the mining, construction, and airline industries. The raw material fabricated will be steel, and other metals. The entire property is located in the M-1 Zone. The proposal includes:

1. A 19,721 square foot building,
2. 12,998 square foot landscaping,
3. 4,219 square foot retention pond,
4. 2-30'X50' septic fields,
5. 13,229 square foot asphalt parking lot, and
6. A 35,939 square foot compacted road base perimeter for access to the overhead doors on the east and north of the building.

Conditional use permits should be approved as long as any harmful impact is mitigated. The Uniform Land Use Code of Weber County, Utah (LUC) already specifies certain standards necessary for mitigation of harmful impact to which the proposal must adhere. With the recommended conditions, the proposed application will meet the applicable land use standards. The following is the staff's evaluation of the request.

Analysis

General Plan: The proposed use conforms to the Western Weber General Plan by increasing industrial/ manufacturing uses in the existing industrial areas of the Western Weber planning area. (West Central Weber County General Plan, 2003, Page 2-1).

Zoning: The subject property is located within the Manufacturing (M-1) Zone. The purpose and intent of the Manufacturing Zone (M-1) can be further described per LUC §104-22-1 as follows:

The purpose of the light manufacturing zone is to provide suitable areas that will accommodate the need for light intensity type manufacturing and its associated accessory uses, some of which may have an environmental impact requiring public review and regulation.

The M-1 Zone has specific standards identified in the LUC §104-22-4 and 104-22-5 that shall be met as part of the development process. The applicable standards are as follows:

No building for industrial uses shall be constructed and no premises shall be used for such purposes on any lot, which has an area of less than 20,000 square feet.

No industrial building or structure shall be located closer than 50 feet to any street or highway. The minimum lot width for all industrial buildings or uses shall be 100 feet. Height of structure shall conform to provisions of title 108, chapter 11.

The total project area is 83,663 square feet and the proposed building is 75 feet from the adjacent street (900 South). The lot width is approximately 614 feet. Currently, Title 108 chapter 11 does not exist. Maximum height for the M-1 zone is none. The proposed height of this building is 35 feet.

Conditional Use Review: The following proposed uses are listed as conditional uses in the M-1 zone: “The fabrication of products made of metals and carbon.” A review process has been outlined in LUC §108-4-3 to ensure compliance with the applicable ordinances and to mitigate anticipated detrimental effects. The following is an analysis of the application reviewed against the applicable conditional use standards:

- **Standards relating to safety for persons and property:** The property is located within the manufacturing zone. Directly to the south and across 900 South Street are residential homes. Detrimental effects related to the safety of persons will be reasonably mitigated by the M-1 zone front setback of 50 feet if the property fronts on streets wider than 80 feet. The fabrication shop will be placed 75’ from the front property line. All fabrication activity will be relegated to within the building.
- **Standards relating to infrastructure, amenities, and services:** The utility services that will be used include, power, gas, and water. The operation will utilize an on-site septic system.
- **Standards relating to the environment:** A condition of approval has been added to the staff recommendation regarding possible degradation of the environment. The applicant shall comply with all state regulations, including DEQ regulations, for the proper disposal of chemicals and machining millings.
- **Standards relating to the current qualities and characteristics of the surrounding area and compliance with the intent of the general plan:** While this use will be within the M-1 zone, it is located adjacent to the A-2 zone. The anticipated impacts such as light, noise, traffic, and odors can be reasonably mitigated through added conditions of approval, should the planning commission feel that additional conditions are necessary. The hours of operation are limited to 6:00 am to 4:30 pm Monday through Thursday and 6:00 am to 12:00 pm Friday, closed Saturday. During these business hours, noise levels from fabrication activities will be less decibels than road traffic on 900 South Street.

Design Review: The proposed conditional use mandates a design review as outlined in LUC §108-1 to ensure that the general design, layout, and appearance of the building remains orderly and harmonious with the surrounding neighborhood. As part of this review, the Planning Commission shall consider the applicable matters based on the proposed conditional use and impose conditions to mitigate deficiencies where the plan is found deficient. The matters for consideration are as follows:

- **Considerations relating to traffic safety and traffic congestion.** As part of this consideration, the applicant has provided a site plan (Exhibit B). The parking lot and pick-up/delivery area are designed for the efficient circulation of passenger vehicles and trucks with trailers. The owner will be responsible to guarantee the site will remain in good

repair. There are a total of 14 employees and it is anticipated that no more than two visiting clients at a time will be on site. The site plan indicates a parking area for 22 parking spaces, including one ADA accessible parking and loading space which is compliant with the parking requirements for a similar business that requires one parking space for each employee during peak shift times and two additional spots for visiting clientele. The parking area is approximately 50 feet from the front property line along 900 South. The developer will be required to install the hard surface parking area, or provide cash escrow for improvements, before the issuance of a certificate of occupancy.

- *Considerations relating to outdoor advertising:* A non-illuminated 90 square foot wall sign will be mounted to the front of the building with durable hardware. The sign will state "Bowen Fabrication". The size of the sign is within the required maximum stated in the Sign Code for Western Weber County.
- *Considerations relating to landscaping.* The proposed landscaping plan indicates that roughly 15% of the project area will be xeriscaped with drought tolerant plants watered with a drip irrigation system and a mix of rocks, gravel, and boulders. The landscaping is required to be installed before issuing a certificate of occupancy for the future buildings.
- *Considerations relating to buildings and site layout.* The building location indicated on the site plan displays compliance with minimum yard setbacks in the M-1 Zone. Parking lot lighting will be located only on the rear of the building. The exterior building material will consist of brown painted metal siding with white accents and brown manufactured stone around the entrance and at the base of the front of the building (see exhibit C).
- *Considerations relating to utility easements, drainage, and other engineering questions.* The applicant will need to adhere to all conditions of the Engineering Division including but not limited to stormwater and surface water drainage, retention facilities, and site clean-up of the property. A condition has been made part of the Planning Division's recommendations to ensure that this standard is met.
- *Considerations relating to prior development concept plan approval associated with any rezoning agreement, planned commercial or manufacturing rezoning, or planned residential unit development approval.* The proposed site does not have any type of development agreement associated with the property; therefore, considerations on this portion of the code are not applicable at this time.

Review Agencies: Before the commencement of work, the applicant will need to receive approval from all applicable agencies. A condition has been made part of the Planning Division's recommendations to ensure that all conditions of the review agencies will be met.

Summary of Planning Commission Considerations

For a conditional use to be approved it must meet the requirements of applicable ordinances listed in this staff report, which include the requirements listed in LUC §108-4-4, under "Decision Requirements", which states:

a) A conditional use shall be approved if reasonable conditions are proposed, or can be imposed, to substantially mitigate the reasonably anticipated detrimental effects of the proposed use in accordance with the standards of this chapter, or relevant standards or requirements of any other chapter of this Land Use Code. When considering any of the standards, the land use authority shall consider the reasonably anticipated detrimental effects of the proposed use in the context of current conditions and, to the extent supported by law, the policy recommendations of the applicable general plan.

b) If the reasonably anticipated detrimental effects of a proposed conditional use cannot be substantially mitigated by the proposal or the imposition of reasonable conditions to achieve compliance with applicable standards, the conditional use may be denied.

The Planning Commission will need to determine if the request for a fabrication shop has met the requirements of the applicable Uniform Land Use Code of Weber County. The Planning Commission may impose additional conditions in order to ensure full compliance with the required standards. In making a decision, the Planning Commission should consider the following questions:

- Does the submittal meet the Uniform Land Use Code of Weber County? If no, then what conditions could be added in order to comply?
- Have the "Decision Requirements" and other applicable ordinances been met?

Staff Recommendation

Staff recommends approval of file# CUP 2020-19, a conditional use permit for a fabrication shop, located at approximately 8052 W 900 S, Ogden. This recommendation for approval is subject to all review agency requirements and with the following conditions:

1. The parking lot will be screened from homes to the south of 900 South Street with a not less than 4' tall screen.
2. Building and site lighting will be fully shielded as to not create a nuisance to neighboring homes or businesses.
3. A building permit is required before commencing construction.
4. The applicant shall comply with all state regulations, including DEQ regulations, for the proper disposal of oils, chemicals, and machining millings.
5. The landscaping and parking improvements are required to be installed, or escrowed for before issuing a certificate of occupancy for the future buildings.

The following findings are the basis for the staff's recommendation:

1. The proposed use conforms to the West Central Weber County General Plan.
2. The proposed use, if conditions are imposed, will not be detrimental to public health, safety, or welfare.
3. The proposed use will not deteriorate the environment of the general area to negatively impact surrounding properties and uses.

Exhibits

- A. Application
- B. Site plan
- C. Building plans
- D. Jamesidney Subdivision
- E. Recorder's plat

Map 1



Weber County Conditional Use Permit Application			
Application submittals will be accepted by appointment only. (801) 399-8791. 2380 Washington Blvd. Suite 240, Ogden, UT 84401			
Date Submitted / Completed	Fees (Office Use)	Receipt Number (Office Use)	File Number (Office Use)
Property Owner Contact Information			
Name of Property Owner(s) Nathan Christensen John Bowen		Mailing Address of Property Owner(s) 1120 W 500 N Centerville Ut, 84014	
Phone 801-706-1921	Fax	Preferred Method of Written Correspondence <input checked="" type="checkbox"/> Email <input type="checkbox"/> Fax <input type="checkbox"/> Mail	
Email Address nchristensen@bowenco.com			
Authorized Representative Contact Information			
Name of Person Authorized to Represent the Property Owner(s) Nathan Christensen		Mailing Address of Authorized Person 1120 W 500 N Centerville UT 84014	
Phone 801-706-1921	Fax	Preferred Method of Written Correspondence <input checked="" type="checkbox"/> Email <input type="checkbox"/> Fax <input type="checkbox"/> Mail	
Email Address nchristensen@bowenco.com			
Property Information			
Project Name Shop	Total Acreage 10	Current Zoning	
Approximate Address 8052 W 900 S Ogden Ut 84404		Land Serial Number(s)	
Proposed Use Fabrication/ Machine Shop			
Project Narrative We are a fabrication and welding company. We do parts for the airline industry as well as mining and construction parts. Our hours of operation are 6:00 A.M. to 4:30 P.M. Monday thru Thursday and 6:00 to 12:00 on Fridays. There are a total of 14 people that work at Bowen Fab at the time being.			

That the proposed use will not lead to the deterioration of the environment or ecology of the general area, nor will produce conditions or emit pollutants of such a type or of such a quantity so as to detrimentally effect, to any appreciable degree, public and private properties including the operation of existing uses thereon, in the immediate vicinity of the community or area as a whole:

Property Owner Affidavit

I (We), Nathan Christensen John Bower, depose and say that I (we) am (are) the owner(s) of the property identified in this application and that the statements herein contained, the information provided in the attached plans and other exhibits are in all respects true and correct to the best of my (our) knowledge.

[Signature]
(Property Owner)

John Bower
(Property Owner)

Subscribed and sworn to me this 17 day of November, 20 20

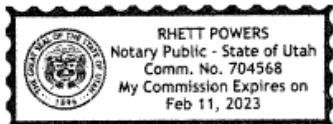

[Signature]
(Notary)

Authorized Representative Affidavit

I (We), _____, the owner(s) of the real property described in the attached application, do authorized as my (our) representative(s), _____, to represent me (us) regarding the attached application and to appear on my (our) behalf before any administrative or legislative body in the County considering this application and to act in all respects as our agent in matters pertaining to the attached application.

(Property Owner)

(Property Owner)

Dated this _____ day of _____, 20 _____, personally appeared before me _____, the signer(s) of the Representative Authorization Affidavit who duly acknowledged to me that they executed the same.

(Notary)

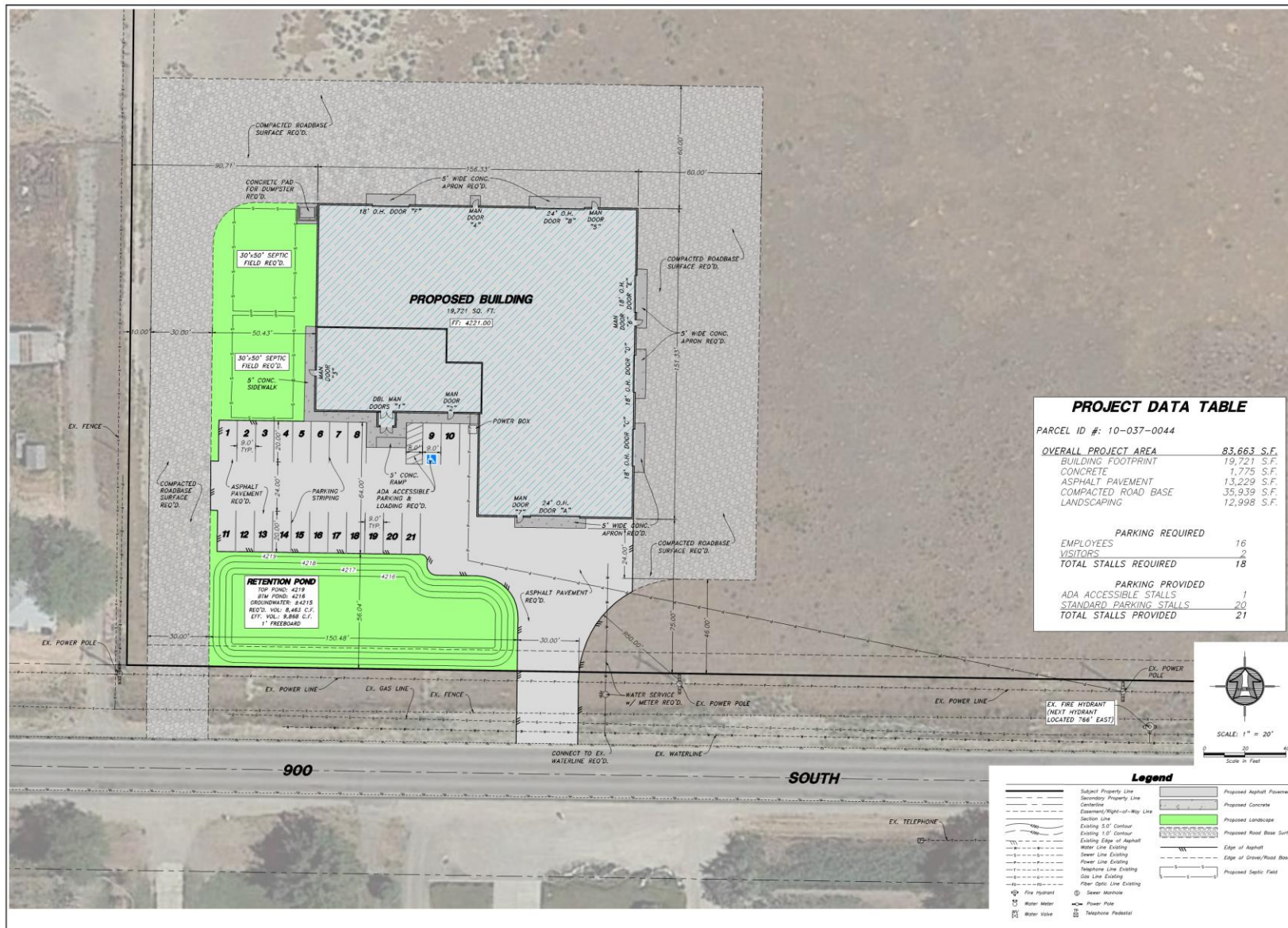

Drawn By: JSC Date: 02/26/20
 Designed By: JSC Date: 02/26/20
 Checked By: JSC Date: 02/26/20
 Approved By: JSC Date: 02/26/20
 Scale: 1" = 20'
 Drawing File: P:\10-037-0044\10-037-0044.dwg
 Job Number: 20-5-48

HANSEN & ASSOCIATES, INC.
 538 North Main Street, Brigham City, UT 84302
 801.732.3471 (801) 381-4469 (435) 782-4272
 Celebrating over 60 Years of Business

BOWEN FABRICATION
 SITE PLAN FOR
 900 SOUTH 7900 WEST
 WEBER COUNTY, UT

Sheet **1** of **1** Sheets

EXTERIOR FINISH KEY

SEE EXTERIOR FINISH SCHEDULE
SEE EXTERIOR FINISH SCHEDULE

EXTERIOR FINISH LEGEND

1. USE APPROVED PREFORMED METAL EXTERIOR DRINK SYSTEM
2. USE APPROVED MANUFACTURED STONE SYSTEM
3. NEW LIGHT FIXTURE - SEE ELECTRICAL
4. HARDWARE SHOP - SEE A/E/D
5. WARE DOOR - SEE A/E/D
6. CONCRETE FOUNDATION - SEE STRUCTURAL
7. FINISHED METAL FINISH - SEE STRUCTURAL
8. METAL SIGN - BASED OFF SHOP LETTERS SET ON CONCRETE SIGN PLATE

EXTERIOR FINISH SCHEDULE

FINISH	DESCRIPTION
P-1	PAINT
P-2	PAINT
P-3	PAINT
M-1	METAL
M-2	METAL
M-3	METAL
ST-1	STONE

ELEVATION A
SCALE: 1/8" = 1'-0"

ELEVATION B
SCALE: 1/8" = 1'-0"

ELEVATION C
SCALE: 1/8" = 1'-0"

ELEVATION D
SCALE: 1/8" = 1'-0"

<p>Bowen Fabrication and Welding</p> <p>1120 W. 900 S. CANTONVILLE, UT 84014 (801) 963-5553</p>						
<p>PROJECT NAME</p> <p>BOWEN FABRICATION</p> <p>8052 W. 900 S. SOUTH OGDEN UTAH</p>						
<p>REVISIONS</p> <table border="1" style="width: 100%; border-collapse: collapse;"> <thead> <tr> <th>NO.</th> <th>DESCRIPTION</th> </tr> </thead> <tbody> <tr> <td> </td> <td> </td> </tr> <tr> <td> </td> <td> </td> </tr> </tbody> </table>	NO.	DESCRIPTION				
NO.	DESCRIPTION					
<p>ISSUE: Sept. 08, 2019</p> <p>PROJECT NO.:</p> <p>DESIGN BY:</p> <p>CHECKED BY:</p>						
<p>SHEET TITLE</p> <p>EXTERIOR ELEVATIONS</p>						
<p>A2.0</p>						

Jamesidney Subdivision

Weber County, Utah
A Part of the Southwest Quarter of Section 15,
Township 6 North, Range 3 West, Salt Lake Base & Meridian
September 2019

SURVEYOR'S CERTIFICATE

I, K. Greg Hansen, do hereby certify that I am a Registered Professional Land Surveyor in the State of Utah in accordance with Title 36, Chapter 22, Professional Engineers and Professional Land Surveyors Act, and I have completed a Survey of the property described on this plat in accordance with Section 17-23-17 and have verified all measurements, and have placed monuments as represented on this plat, and have hereby Subdivided said tract into two (2) lots, known hereafter as Jamesidney Subdivision in Weber County, Utah, and have been correctly done to the designated spots and to true and correct representation of the same described herein included in said Subdivision, based upon data compiled from reports in the Weber County Recorder's Office and from said survey made by me or under my supervision on the ground. I further hereby certify that the requirements of all applicable statutes and ordinances of Weber County Concerning Zoning Requirements regarding all measurements have been complied with.



Signed this 9th day of March, 2020.
K. Greg Hansen P.L.S.
Utah Land Surveyor License No. 167819

SUBDIVISION BOUNDARY DESCRIPTION

A PART OF THE SOUTHWEST QUARTER OF SECTION 15, TOWNSHIP 6 NORTH, RANGE 3 WEST OF THE SALT LAKE BASE AND MERIDIAN.
BEGINNING AT THE INTERSECTION OF THE NORTH RIGHT-OF-WAY LINE OF 900 SOUTH STREET AND THE EAST LINE OF SAID SOUTHWEST QUARTER LOCATED 47.63 FEET NORTH OF 0029°13' EAST ALONG THE EAST LINE OF SAID SOUTHWEST QUARTER FROM THE SOUTH QUARTER CORNER OF SAID SECTION 15;
RUNNING THENCE NORTH 89°22'33" WEST 41.05 FEET ALONG SAID NORTH RIGHT-OF-WAY LINE TO THE EAST LINE OF SAID SECTION 15, A HOLEY THOMPSON PROPERTY, TAX ID NO. 10-037-0910; THENCE ALONG THE BOUNDARY OF SAID THOMPSON PROPERTY THE FOLLOWING THREE (3) COURSES: (1) NORTH 00°29'13" EAST (NORTH BY RECORD) 162.50 FEET; (2) NORTH 89°42'58" WEST (WEST BY RECORD) 254.00 FEET; AND (3) SOUTH 00°29'13" WEST (SOUTH BY RECORD) 167.82 FEET TO SAID NORTH RIGHT-OF-WAY LINE; THENCE NORTH 89°27'05" WEST 1042.26 FEET ALONG SAID NORTH RIGHT-OF-WAY LINE TO THE WEST LINE OF THE SOUTHWEST QUARTER OF SAID SOUTHWEST QUARTER; THENCE NORTH 00°29'13" EAST 740.56 FEET ALONG SAID WEST LINE; THENCE SOUTH 89°27'05" EAST 133.41 FEET TO THE EAST LINE OF SAID SOUTHWEST QUARTER; THENCE SOUTH 00°29'13" WEST 738.85 FEET ALONG SAID EAST LINE TO THE POINT OF BEGINNING, CONTAINING 21.689 ACRES.

OWNER'S DEDICATION AND CERTIFICATION

We the undersigned owners of the herein described tract of land, do hereby set apart and subdivide the same into lots and streets as shown hereon and some said tract, Jamesidney Subdivision and do hereby dedicate to public use all these parts or portions of said tract of land designated as streets, the same to be used as public thoroughfares and also grant and dedicate a perpetual right and easement over, upon and under the lands designated herein as public utility easements, the same to be used for the installation, maintenance and operation of public utilities as may be authorized by the governing authority, with no buildings or structures being erected within such easements.

Signed this 18 day of March, 2020.

James N. Brown
James N. Brown, Registered Agent of Jamesidney Enterprises, LLC, a Utah Limited Liability Company

LIMITED LIABILITY COMPANY ACKNOWLEDGMENT

STATE OF UTAH
COUNTY OF DAVISON
On this 18 day of MARCH, 2020, personally appeared before me, James N. Brown, who being by me duly sworn did say and acknowledge that he is a Registered Agent of Jamesidney Enterprises, LLC, a Utah Limited Liability Company (LLC), which LLC is the owner of the real property listed herein, and executed the foregoing instrument as the authorized agent of the LLC, and that said authorization is sign on behalf of the LLC come pursuant to a Resolution of the Managers, the Certificate of Organization, and/or the Operating agreement of the LLC.
James N. Brown
Notary Public

NAMKALIVE
The purpose of this survey was to establish and set the property corners of the two (2) Lot Subdivision as shown and described herein. This survey was ordered by Nate Christensen. The control used to establish the property corners was the existing Weber County Survey Monumentation Station Twp 6 North, Range 3 West, S.L.S.B.M. The North Right-of-Way of 900 South Street was determined from Entry No. 2760753 in the Weber County Recorder's Office. The Right-of-Way and Bearing of 7900 West Street was determined from Entry No. 2881540 in the Weber County Recorder's Office. The South Line of the Southwest Quarter of said Section which bears North 89°27'05" West, with North, State Plane, Calculated N.A.D.83 Bearing.

THIS RECORD OF SURVEY 6475

WEBER COUNTY RECORDER
ENTRY NO. 3068335 FEE PAID \$24.00 FILED FOR RECORD AND RECORDED 15-141-2820 3:55 PM IN BOOK 95 OF OFFICIAL RECORDS PAGE 18 RECORDED FOR JIM BROWN
CERIAN H. KILTS
COUNTY RECORDER
BY: *[Signature]* DEPUTY

LEGEND

- Subject Property Line
- Interior Lot Lines
- Adjoining Property Line
- Dashed Line
- Public Utility Easement (P.U.E.)
- Other
- Fence Line
- Edge of Existing Asphalt
- Found rebar set by others
- Set 5/8"x24" Rebar With Cap
- Section Corner

WEBER COUNTY ENGINEER
I hereby certify that the Required Public Improvement Standards and Drawings for this Subdivision Conform with the County Standards and the Amount of the Financial Guarantee is Sufficient for the Installation of these Improvements.
Signed this 11th day of May, 2020.
Greg Mose
Weber County Engineer

WEBER COUNTY PLANNING COMMISSION APPROVAL
This is to Certify that this Subdivision Plat was duly Approved by the Weber County Planning Commission.
Signed this 24 day of July, 2020.
[Signature]
Chairman, Weber County Planning Commission

NOTE:

- All public utility easements (P.U.E.) are 10.0 foot wide unless otherwise noted.
- Rebar and cap set on all back of corners.
- Sewer system to be installed as per systems approved by the Weber-Morgan Health Department.
- Due to the topography and the location of this Subdivision, all corners will accept responsibility for any storm water runoff from the road adjacent to this property until curb and gutter is installed.
- Due to high ground water the lowest habitable floor elevation can not be lower than 4218' (N.G.D. 29)
- An Erosion Permit is required for all work done within the existing right-of-way.
- Details of asphalt, curb & gutter and sidewalks will be provided by administrative Approval on Feb. 18, 2020.

Developer:
Nate Christensen
P.O. Box 937
Cannonville, Utah 84014
(801) 796-1921

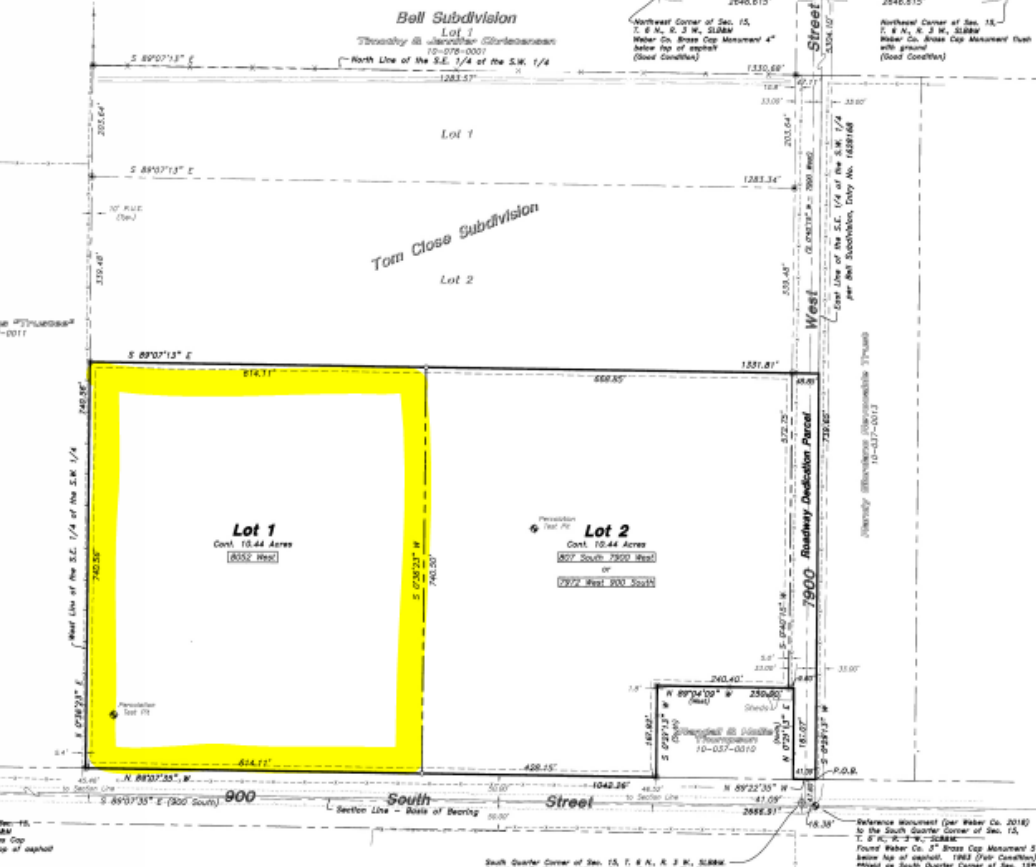

WEBER COUNTY COMMISSION ACCEPTANCE
This is to Certify that this Subdivision Plat, the Dedication of Streets and all conditions for approval by this office have been satisfied. The approval of this Plat by the Weber County Surveyor does not relieve the contractor land surveyor who executes this plat from the responsibilities and/or liabilities associated therewith.
Signed this 20th day of June, 2020.
[Signature]
Chairman, Weber County Commission
[Signature] Admin. Assistant

WEBER COUNTY SURVEYOR
I hereby certify that the Weber County Surveyor's Office has Released this Plat and all conditions for approval by this office have been satisfied. The approval of this Plat by the Weber County Surveyor does not relieve the contractor land surveyor who executes this plat from the responsibilities and/or liabilities associated therewith.
Signed this 18th day of June, 2020.
[Signature]
Weber County Surveyor

WEBER COUNTY ATTORNEY
I have Examined the Financial Guarantee and Other Documents Associated with this Subdivision Plat, and in my Opinion they Conform with the County Ordinance Applicable thereto and may be Filed and Aired.
Signed this 29th day of June, 2020.
[Signature]
Weber County Attorney

WEBER-MORGAN HEALTH DEPARTMENT
I hereby certify that the Sewer, Percolation Rates, and Site Conditions for this Subdivision have been investigated by this office and are approved for on-site Wastewater Disposal Systems.
Signed this 24th day of May, 2020.
[Signature]
Weber-Morgan Health Department

HAI HANSEN & ASSOCIATES, INC.
Consulting Engineers and Land Surveyors
538 North Main Street, Brigham, Utah 84302
Visit us at www.hais.com
Brigham City, Utah
(435) 733-3481 (801) 380-4808 (435) 752-0272
Celebrating over 60 Years of Business

PART OF THE SW. 1/4, OF SECTION 15, T.6N., R.3W., S.L.B. & M.
JAMESIDNEY SUBDIVISION

174

TAXING UNIT: 389

IN WEBER COUNTY
SCALE 1" = 100'

SEE PAGE 37

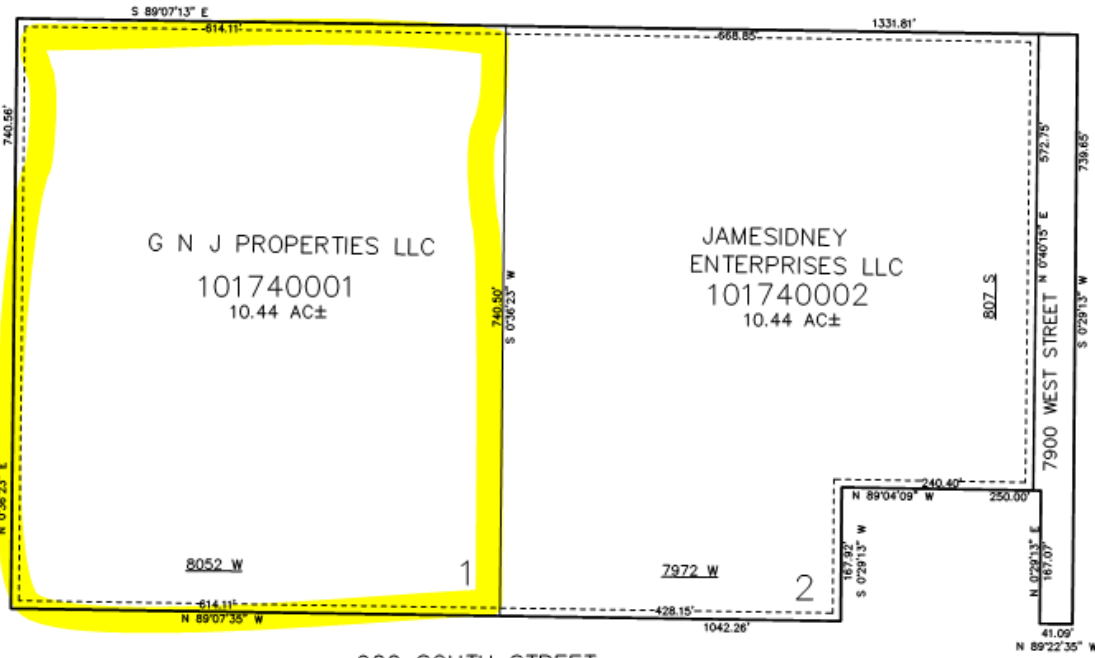

900 SOUTH STREET

SEE PAGE 37

10' UTILITY & DRAINAGE EASEMENTS EACH
SIDE OF PROPERTY LINES AS INDICATED
BY DASHED LINES EXCEPT AS OTHERWISE
SHOWN.

FOR COMPLETE ENG DATA SEE
ORIGINAL DEDICATION PLAT IN
BOOK 88, PAGE 81 OF RECORDS.



Staff Report to the Western Weber Planning Commission

Weber County Planning Division

Synopsis

Application Information

Application Request:	Consideration and action for a conditional use request for Winston Park, a Planned Residential Unit Development consisting of 57 residential units, and two open space parcels, totaling approximately 17 acres.		
Type of Decision:	Administrative		
Applicant:	Wade Rumsey		
Agenda Date:	December 8, 2020		
Approximate Address:	3701 West 1800 South		
Project Area:	40.259 Acres		
Zoning:	A-1		
Existing Land Use:	Residential/Agricultural		
Proposed Land Use:	Residential		
Parcel ID:	15-078-0002		
Township, Range, Section:	T6N, R2W, Section 28 NE		

Adjacent Land Use

North:	1800 South St.	South:	Agricultural
East:	Agricultural	West:	Agricultural/Residential

Staff Information

Report Presenter:	Tammy Aydelotte taydelotte@co.weber.ut.us 801-399-8794
Report Reviewer:	SB

Applicable Ordinances

- Title 101, Chapter 1 General Provisions, Section 7, Definitions
- Title 104, Zones, Chapter 5 Agricultural A-1 Zone
- Title 108, Chapter 1 Design Review
- Title 108, Chapter 4 Conditional Uses
- Title 108, Chapter 5 Planned Residential Unit Development
- Title 108, Chapter 8 Parking and Loading Space, Vehicle Traffic and Access Regulations

Summary and Background

This application is a conditional use permit request for a Planned Residential Unit Development. Receiving a recommendation for approval from the Planning Commission is the first step in the PRUD process. If the conditional use permit is approved by the Commission then the applicant will be allowed to begin the subdivision process. Winston Park PRUD includes 57 lots, ranging in size from 12,000-13,000 square foot lots. The open space will consist of two parcels totaling approximately 17 acres.

Under the PRUD ordinance, a development is able to receive additional lots than what the zone normally allows. The extra density is called Bonus Density. **The applicant is eligible to receive a 30 percent bonus density based on the preservation of 30% of the adjusted gross acreage as open space, as defined in 101-1-7. However, if the applicant preserves open space area above 30 percent, the county may grant a bonus density of up to 50 percent.** Under the PRUD ordinance the applicant has chosen to do the following to warrant the requested additional density:

“The county may award bonus densities based on an accumulation of any combination of the following:

2. (a) If a PRUD provides and implements an approved roadway landscape and design plan that includes, but is not necessarily limited to, vehicle and pedestrian circulation, lighting, and street trees of an appropriate species, size of at least a two-inch caliper, and quantity of not less than eight trees for every 100 feet of road length, **up to 20 percent bonus density may be granted.**

.....

2. (d) If a PRUD provides a common area that offers easily accessible amenities such as trails, parks, or community gardens, that are open for use by the general public, **up to a 15 percent bonus density may be granted.**

There will be walking paths/sidewalks throughout the PRUD that will connect to sidewalk along 1800 South Street.

2 (g) 1. For a parcel containing at least ten acres but fewer than 20 acres, **up to a 15 percent bonus density may be granted.** The larger open space parcel contains over 15 acres, thus satisfying this requirement.

2. (i) If a PRUD provides for the development of excess sewage treatment capacity, up to a **five percent bonus density may be granted.**

With the combination of the above bonus density options, the applicant is able to receive up to **50 percent bonus density.**

Analysis

General Plan: The proposal conforms to the West Central Weber County General Plan by supporting agriculture and encouraging residential cluster style development with a minimum 30% open space.

Zoning: The subject property is located in the Agricultural A-1 Zone.

The purpose and intent of the A-1 zone is identified in the LUC §104-5-1 as:

“The purpose of the A-1 Zone is to designate farm areas, which are likely to undergo a more intensive urban development, to set up guidelines to continue agricultural pursuits, including the keeping of farm animals, and to direct orderly low-density residential development in a continuing rural environment.”

Lot area, frontage/width and yard regulations: The purpose and intent of a Planned Residential Unit Development (PRUD) is intended to *“allow for diversification in the relationship of various uses and structures to their sites and to permit more flexibility of such sites and to encourage new and imaginative concepts in the design of neighborhood and housing projects in urbanizing areas.”* The proposed PRUD utilizes the allowed flexibility to create neighborhoods with lots ranging in size from 0.23 acre lots to .99 acre lots and sized to accommodate single family homes.

The proposal includes the following minimum single family development standards:

- Yard development standards:
 - Front Yard: 20 feet
 - Side Yard: 6 feet
 - Rear Yard: 20 feet
- Maximum Building Height:
 - Single Family: 35' (average building height)

Based on the allowed flexibility of a PRUD, the proposed layout, lot configurations and lot sizes are acceptable. In order to provide clear site standards at intersecting streets throughout the development, staff recommends adding to the minimum setback standards on the preliminary and final subdivision plats a setback for “Side, facing street corner lot”. This setback should be a minimum of 15 feet. A condition of approval has been added to staff’s recommendation to ensure the additional “Side, facing street corner lot: 15 feet” setback standard is added to the preliminary and final subdivision plats for review and approval as required per LUC §104-5-7.

During each individual phase, the County review agencies will be able to more thoroughly vet the preliminary and final development details to ensure that all conditions of approval and the applicable subdivision standards are met. Applicant is planning one phase for this development.

Conditional Use Review: The proposed PRUD is conditionally allowed in the A-1 zone. A review process has been outlined in LUC §108-4-3 to ensure compliance with the applicable ordinances and to mitigate anticipated detrimental effects. The standards for consideration for conditional use permits include:

- Standards relating to safety for persons and property
- Standards relating to infrastructure, amenities, and services
- Standards relating to the environment
- Standards relating to the current qualities and characteristics of the surrounding area and compliance with the intent of the general plan
- Standards relating to performance

- Standards generally
- Voluntary contributions providing satisfactory compliance with applicable standards

These standards have been combined with the design review standards in this report. As a requirement of the conditional use permit, the applicant has provided a “Will-Serve Letter” from Taylor West Weber Water Improvement District and is working with Weber County Engineering regarding additional infrastructure for Central Weber Sewer District for culinary and waste water services. If the applicant has not already annexed into the Central Weber Sewer District, it must be completed prior to final approval of the subdivision within this proposed PRUD. The applicant, during the subdivision phase, will be required to provide proof of secondary water availability. The applicant has provided the required material to facilitate a thorough review of the proposed project including the project narrative, vicinity map, conceptual layout, and proposed landscaping for the development.

The general requirements for consideration by the County Commission for the proposed planned residential unit development include items such as the architectural design of buildings and their relationship on the site and development beyond the boundaries of the proposal; which streets shall be public and which shall be private; the entrances and exits to the development and the provisions for internal and external traffic circulation and off-street parking; the landscaping and screening as related to the proposed uses within the development and as a means of its integration into its surroundings; lighting and the size, location, design, and quality of signs if any; the residential density of the proposed development and its distribution as compared with the residential density of the surrounding lands, either existing or as indicated on the zoning map or general plan proposals of the county as being a desirable future residential density.

Bonus Density Request: The County may grant a bonus density of up to 30 percent if the applicant preserves open space area equal to or greater than 30 percent of the PRUD's adjusted gross acreage per LUC §108-5-5(c)(2). The proposal meets this bonus density requirement. If the applicant preserves open space area above 30 percent, the county may grant a bonus density of up to 50 percent; however, overall bonus density potential shall be no greater than a percentage equal to the percentage of the PRUD's total area preserved as open space. The proposal dedicates 17 acres of open space which is 50% of the adjusted gross acreage; therefore qualifying for up to the 50 percent bonus density.

With the **50** percent bonus density, the applicant will be able to add an additional **19** units to the **38** base units for an overall density of **57** units.

Design Review: The proposed conditional use mandates a design review as outlined in the LUC §108-1 to ensure that the general layout and appearance of the development shall not impair the orderly and harmonious development of the neighborhood nor impair investment in and occupation of the neighborhood. As part of this review, the County Commission shall consider the relevant standards for the proposed conditional use and impose conditions to mitigate deficiencies where the plan is found deficient. The standards for consideration are as follows:

- 1) *Considerations relating to traffic safety and traffic congestion.* The proposal includes access from the existing County road identified as 1800 South. Along with the creation of 5 additional county roads, a sidewalk or pathway will be installed, and curb and gutter will either be installed or deferred along 1800 South St, per County Engineering. Within the PRUD, sidewalk and park strips will be located on both sides of the roadway within the subdivision.
- 2) *Considerations relating to landscaping, screening and buffering.* The applicant has, on a conceptual level, addressed the areas in the development that will be landscaped. Staff feels that the landscaping, screening and buffering requirements of the Design Review as outlined in LUC §108-1-4(3) are met with the submitted landscape plan. Additional landscaping plans will be included in the preliminary and final subdivision design for the open space area and will be guaranteed with a financial guarantee upon recordation of the final subdivision plat. Sidewalk along 1800 South Street shall be required, with a possible deferral for curb and gutter (Engineering requirements).
- 3) *Considerations relating to buildings and site layout.* The applicant has provided a concept plan showing the buildings and site layout (See Exhibit B). In reviewing the proposed layout, additional conditions, aside from those proposed in this staff report, are not required at this time.

Common Area/Open Space: The general requirements for a PRUD identify the need to preserve common open space. The applicant is proposing to preserve approximately 17 acres of agricultural property. The applicant has indicated, through a submitted narrative that the open space will be dedicated to either grazing or farming, involving agreements with local residents who wish to utilize the open space for these purposes. The proposed layout identifies the agricultural parcel, and is labeled as such.

5) *Considerations relating to utility easements, drainage, and other engineering questions.* During the preliminary and final subdivision process, the applicant will be required to provide civil engineered drawings that identify the existing and proposed topography, contour lines, utilities, easements and drainages. The conceptual plans appear to provide adequate setbacks for the yard; however further evaluation will take place during the preliminary plan review. The applicant will need to adhere to all conditions of the Engineering Division including but not limited to easements and utilities to and through the property, site improvements and storm water drainage.

6) *Considerations relating to prior development concept plan approval associated with any rezoning agreement, planned commercial or manufacturing rezoning, or planned residential unit development approval.* The proposed site does not have any type of development agreement associated with the property; therefore considerations pertaining to this portion of the code are not applicable at this time.

Review Agencies: Due to the conceptual nature of the proposal, the Weber County Surveyor's Office has not reviewed the proposal. The Weber Fire District has reviewed this project, requesting additional information. The Engineering Division has not yet reviewed the proposal. A condition of approval has been made part of the Planning Staff's recommendations to ensure that any conditions of the applicable reviewing agencies are strictly adhered to.

Public Notice: Public notice is not required for conditional use applications.

Summary of County Commission Considerations

- Does this proposal comply with the applicable PRUD ordinance?
- In considering the proposed planned residential unit development, the County Commission shall review and consider the following, as applicable:
 - *The architectural concept of buildings and their relationship on the site and development beyond the boundaries of the proposal.*
 - *Which streets shall be public and which shall be private; the entrances and exits to the development and the provisions for internal and external traffic circulation and off-street parking.*
 - *The landscaping and screening as related to the proposed uses within the development and their integration into the surrounding area.*
 - *The residential density of the proposed development and its distribution as compared with the residential density of the surrounding lands, either existing or as indicated on the zoning map or general plan proposals of the county as being a desirable future residential density.*

Staff Recommendation

Staff recommends approval of the request for a conditional use request for Winston Park, a Planned Residential Unit Development consisting of 57 residential units, and two open space parcels (1.275 acres and 15.046 acres) used for agricultural purposes.

1. The following setback standard shall be added to the final subdivision plats for review and approval: Front – 20', side – 8', rear – 20', corner lot with a side facing a street – 20'.
2. Street light design shall be approved by Planning Department prior to issuance of a conditional use permit.
3. Sidewalk, curb and gutter will be installed along the applicant's frontage of 1800 South as well as along the roads within the subdivision.

This recommendation is based on the following findings:

1. The proposed PRUD conforms to the West Central Weber County General Plan.
2. The PRUD is intended to allow for more flexibility of residential building sites.
3. The building uses, locations, lot area, width, yard, height and coverage regulations proposed are acceptable as shown on the conceptual drawings.
4. Up to a 50 percent bonus density may be granted based on the following:
 - a. If the applicant preserves open space area above 30 percent, the county may grant a bonus density of up to 50 percent; however, overall bonus density potential shall be no greater than a percentage equal to the percentage of the PRUD's total area preserved as open space. The proposal dedicates approximately 17 acres of open space (two parcels) which is 50% of the adjusted gross acreage; therefore qualifying for up to the 50 percent bonus density.
5. The proposal will not be detrimental to the public health, safety, or welfare.
6. The proposal will not deteriorate the environment of the general area so as to negatively impact surrounding properties and uses.

Exhibits

- A. Project Narrative and Bonus Density Calculations
- B. Winston Park PRUD Conceptual Plan
- C. Proposed Lot Layout
- D. Culinary Water Preliminary Approval Letter

Location Map



Winston Park Subdivision
3701 W 1800 S
Ogden, UT. 84401

Ogden 3, LLC
Owners and managers:
Igor Maksymiw
Wade Rumsey

Overall Development Plan for Winston Park

The location of this 40 acre parcel is located at 3701 W 1800 S. The location of the property also lends itself too more a country, rural, and suburbia feel. The parcel of land is under the A-1 zoning and we are seeking a 'Planned Residential Unit Development' [PRUD] for this parcel. We envision individuals and families having some open spaces to get out and have outdoor things to do yet be able to take advantage of all of the convenient services of planned subdivision. The subdivision will offer 1/3 acre lots ranging from 12,000-13,000 square foot lots. Within the subdivision itself we will create a small park where owners will commonly share (on the back sides of their properties) for extra space for kids to run and play. We will also feature a walking trail for exercise and fresh air out in the common open space area.

Common Open Space

A 20 ft wide gravel road, built to hold 75,000 lbs will be constructed for the use of Weber County Fire Department, as an alternative road, in case of fire and emergency uses. An easement between lots 26 and 27 will be established for the fire emergency access and to aid those living in the southern most part of the subdivision providing access to the gravel walking trail. Trees and grass will be planted in the park and walking trail areas for subdivision beautification.

Common Open Space for Agricultural Use

Approximately 17 acres within the development will be dedicated pasture or farming land East and North East of the planned subdivision (as shown in our conceptual plan). This open space will be dedicated to either horse grazing or agricultural farming purposes. If used for horses or cow grazing, a fence will be constructed and maintained by the leasee. This will provide a more rural, open feeling for those that purchase land within Winston Park.

Roads and Foot Paths within the Subdivision

60 ft wide road will be built throughout the subdivision providing ample room for regular traffic and emergency vehicles throughout Winston Park. Sidewalks will be found on both sides of the roads. Green space will be also be found between the curb of the road and the sidewalks for grass and trees to enhance the look and feel of the subdivision.

Housing types

No basements will be allowed. Slab on grade houses or split level type homes that are built out of the ground will only be the house types allowed within Winston Park. A minimum of 1,800 square foot homes will be the requirement for the beginning home size.

Building & Construction

A mixed approach will take place for individual lot development & Construction. Ogden 3, LLC will engage builders to purchase lots. Lots will also be sold to independent individuals for owners to engage builders of their preference.

Bonus Density Regulations Satisfied

In Section 108-5-5:

2 (a) If a PRUD provides and implements an approved roadway landscape and design plan that includes, but is not necessarily limited to, vehicle and pedestrian circulation, lighting, and street trees of an appropriate species, size of at least a two-inch caliper, and quantity of not less than eight trees for every 100 feet of road length, up to 20 percent bonus density may be granted.

In our landscape plan we will be providing sidewalks on both sides of the roads throughout the subdivision. Between the sidewalk and the curb we will have a green strip where we will be planting two-inch caliper trees as described in the paragraph above.

2 (d) If a PRUD provides a common area that offers easily accessible amenities such as trails, parks, or community gardens, that are open for use by the general public, up to a 15 percent bonus density may be granted.

As shown on our plat, we will have a small park within the subdivision. This will serve as a great area where all the homes on the block will have extra green space to allow kids to play safely. We will also build in a walking trail on the outside part of the subdivision.

2 (g) 1. For a parcel containing at least ten acres but fewer than 20 acres, up to a 15 percent bonus density may be granted.

As shown in our plan, we will designate 15 + acres to agriculture or grazing ground. This area will provide additional open space for residents within Winston Park and create a country, or out of town feel to the area.

2 (i) If a PRUD provides for the development of excess sewage treatment capacity, up to a five percent bonus density may be granted.

Ogden 3, LLC have been involved in working with Sierra Homes and Weber County Engineer, Chad Meyerhoffer to support and help provide additional sewer capacity for the area. We believe there is excess capacity with the new pump station built near our development, Winston Park.

Thank you,

Ogden 3, LLC
Wade Rumsey 208 313 9113
Igor Maksymiw 801 209 6759

Base and Bonus Density Calculation under (PRUD):

Base:

40.259 Acres Total Parcel
4.873 Acres Roads
35.386 Acres
 / 2 (half or 50% for open space)
17.693 Acres (50% open space goal)

35.386 acres
x 43,560
1,541,414.16 Total Square Feet
/ 40,000 per lot zoning
38.535 Base Lot Density per zoning

Bonus: (based on comprehensive plan)

- 1) 2" caliper trees planted throughout development
- 2) Provide dedicated 50% Open Space, preserved
- 3) Additional Sewer, participating in the new pump station

38.535
x 50%
19.267 Bonus lots

38.535 Base Lots
19.267 Bonus Lots
57.802 Total Lots



WINSTON PARK SUBDIVISION CONCEPTUAL SITE PLAN

PLANT SCHEDULE

SYMBOL	QTY	COMMON / BOTANICAL NAME	CODE	DL
	100	Asian Iron Bark Maple / Asian Ironwood / Asian Iron Tree	84S	7' Cd
	50	Asian Iron Bark Maple / Fraxinus americana / Ash / Iron Tree	84S	7' Cd
	20	Canada Red Chokeberry / Prunus virginiana / Canada Red	84S	7' Cd
	30	Common Hackberry / Carya cordolata	84S	7' Cd
	40	Ulmus parviflorus / Elm	84S	7' Cd
	50	Shrubland Laurel / Fraxinus americana / Fraxinus	84S	7' Cd



WHEBER COUNTY
WINSTON PARK SUBDIVISION
CONCEPTUAL SITE PLAN

DESIGNED BY: CDR
DATE: 2/18/2020
DRAWN BY: BAW

Exhibit C-Proposed Lot Layout

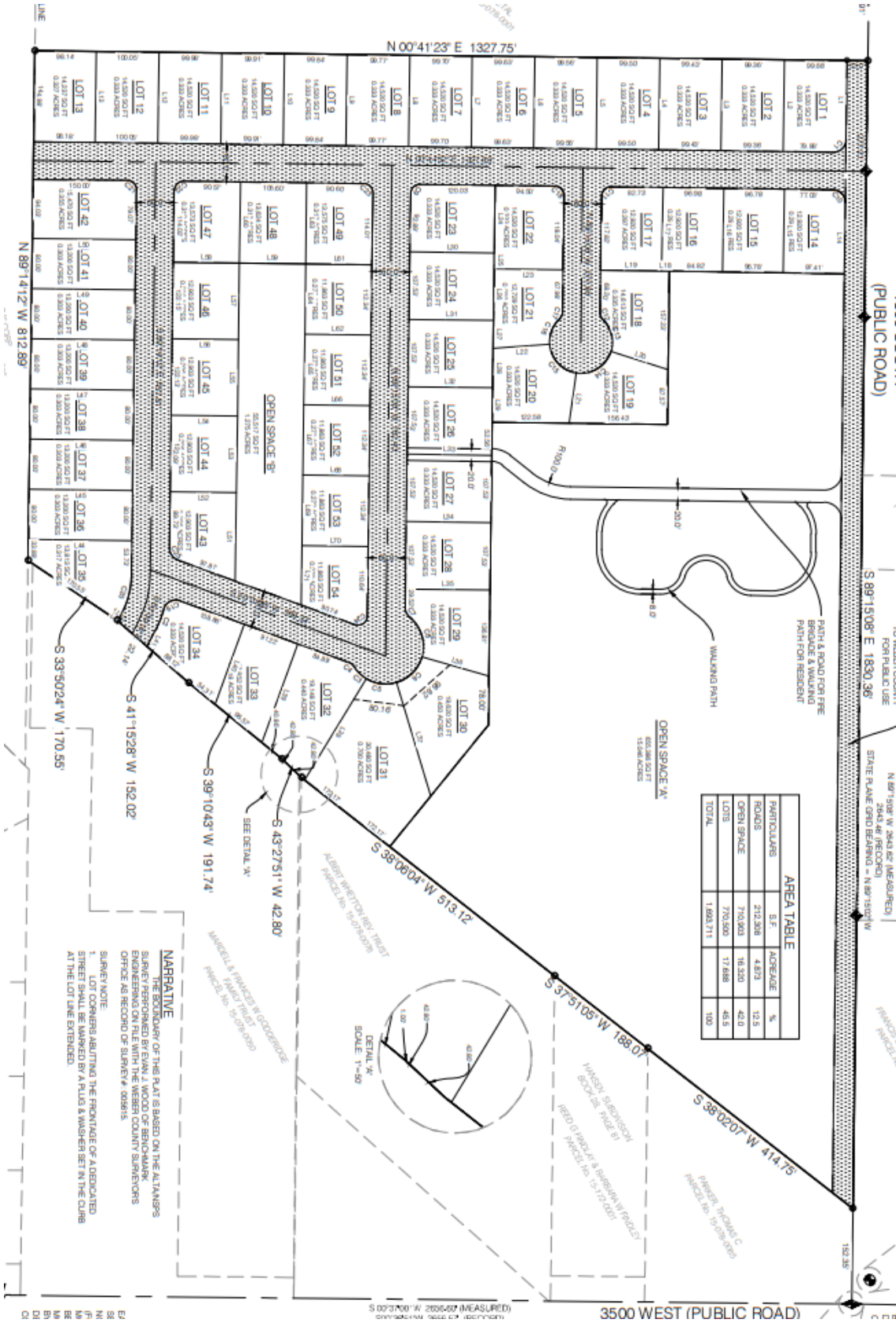



2815 WEST 3300 SOUTH
WEST HAVEN, UTAH 84401
801-731-1668
11/17/2020

Weber County Planning Commission
2380 Washington Boulevard
Ogden, Utah 84401

To Whom It May Concern:

This is to inform you that ***preliminary*** approval has been given and the District has the capacity to provide culinary water only for 54 lots for the Winston Park Subdivision at the approximate address 3600 W. 1800 S. Taylor, Utah.

Requirements:

- Plan review fee= \$100 per lot = \$5400
- Water rights fee = Must be paid before subdivision approval is given. \$4363.00 per lot (Total \$235,602.00 54 lots) or current cost when paid.
- It is expected that the developer will upgrade the water line along the entire frontage of 1800 South. The existing water line is now a 6" line which will not accommodate the new subdivision. A new line needs to be installed. An 8" line is required for the subdivision. The District would like to participate in the upgrade and install a 12" line for future growth. The District will pay the offset from an 8" line to a 12" line.
- Secondary Water = Must connect to Hooper Irrigation pressurized secondary water.
- Impact Fees (\$5,228 per lot or current cost when paid).
- Taylor West Weber Water District reserves the right to make or revise changes as needed or as advised by the district engineer or the district attorney.

SUBDIVISION APPROVAL SHOULD NOT BE ISSUED UNTIL FINAL APPROVAL IS GIVEN BY TAYLOR WEST WEBER WATER. Final

approval is subject to meeting all of the requirements of the District and all fees being paid and received. This letter expires six months from the date it is issued.

Sincerely,

A handwritten signature in blue ink, appearing to read "Ryan Rogers".

Expires 5/17/2021

Ryan Rogers – Manager
Taylor West Weber Water Improvement District



Staff Report to the Western Weber Planning Commission

Weber County Planning Division

Synopsis

Application Information

Application Request:	Consideration and action for a conditional use request for a basement accessory apartment within an existing single-family dwelling located at 2259 S. 3750 W., Ogden
Agenda Date:	Tuesday, December 08, 2020
Applicant:	Dale McCrary, Owner
File Number:	CUP 2020-16

Property Information

Approximate Address:	2259 S 3750 W, Ogden
Project Area:	1.1 Acres
Zoning:	A-1
Existing Land Use:	Residential
Proposed Land Use:	Residential/Accessory Apartment
Parcel ID:	15-724-0001
Township, Range, Section:	T6N, R2W, Section 28, SE 1/4

Adjacent Land Use

North:	Residential	South:	Residential
East:	Agricultural	West:	Residential

Staff Information

Report Presenter:	Scott Perkes sperkes@co.weber.ut.us 801-399-8772
Report Reviewer:	SB

Applicable Ordinances

- Title 108-19 Accessory Apartments
- Title 108, Chapter 4 Conditional Uses

Summary and Background

The applicant is requesting approval of a conditional use permit for an accessory apartment located at 2259 S 3750 W, Ogden (see **Exhibit A**). The applicant is currently building a single-family home on Lot 1 of the Summerset Farms Phase 1 subdivision. The proposal is to convert a portion of the home's walk out basement into an accessory apartment to rent out as a dwelling. The proposal complies with the applicable ordinances of the Weber County Land Use Code and has received approvals from both Fire and Engineering. The following is an analysis of the proposal reviewed against the applicable ordinances.

Analysis

General Plan: The proposal conforms to the West Central Weber County General Plan by promoting affordable housing options while maintaining the rural character of the A-1 zone.

Zoning: The subject property is located in the Agricultural A-1 Zone.

The purpose and intent of the A-1 zone is identified in the LUC §104-5-1 as:

"The purpose of the A-1 Zone is to designate farm areas, which are likely to undergo a more intensive urban development, to set up guidelines to continue agricultural pursuits, including the keeping of farm animals, and to direct orderly low-density residential development in a continuing rural environment."

Water & Wastewater: The applicant has submitted will-serve letters from both Taylor West Weber Water and Central Weber Sewer for both culinary water and wastewater connection/service (See **Exhibit B**).

LUC 108-19-2 explains the requirements for accessory apartments within zones that allow single family dwellings. Below each criteria an explanation of how this application meets the criteria is provided:

Accessory apartments may be permitted, by conditional use permit, in any zone in which single-family residential dwelling units are allowed, under the following specifications:

- (a) *Relationship to principal use; appearance. An apartment may be established only accessory to a permitted dwelling. The apartment unit shall have common walls, roof, and/or floors with the principal dwelling. The minimum width shall be 20 feet with the livable floor area of the main home, with an opening from the accessory apartment to the main home, into a common living area of the main home. The opening can be closed off by a door. Basement apartments meet this requirement with the common floor. The stairs which lead to the main floor and open up into the common living space of the main home can be closed off by a door. The accessory apartment opening into a garage or storage is not considered livable space. The outward appearance of the accessory dwelling shall be consistent with the design and character of the principal dwelling in its construction, materials and finish treatment. There shall be no more than one apartment accessory to a permitted dwelling. There shall be no separate address, mailbox or utilities.*

The proposed accessory apartment is a portion of a walkout basement and meets the requirement of “shared common living area” with the common floor of the primary dwelling. The applicant has stated that there will be no separate address, mailbox or utilities.

- (b) *Floor area. Living area of an accessory apartment shall contain a minimum of 400 square feet and shall not exceed a maximum of 800 square feet; there shall be no more than two bedrooms in such apartments. In no case shall the floor area exceed 25 percent of the gross livable floor area of the total structure.*

The floor area of the accessory apartment is 797.25 square feet. The total livable floor area of the home is 3,770 sq. ft. Twenty-five percent of the livable floor area of the entire home is 942.5 square feet. As such, the proposed accessory apartment does not exceed the 25% of gross livable area restriction.

- (c) *Location. An accessory apartment shall be so located upon a lot to comply with all dimensional requirements of the zoning district for new construction. An apartment located within the perimeter of an existing (by location) nonconforming dwelling, shall not be subject to such requirements. No apartment shall be located in a basement or cellar unless such basements or cellar constitutes a walk-out basement. Additions for the purpose of an accessory apartment shall be made only above or to the side or rear of the principal dwelling.*

The proposed accessory apartment is a portion of a walkout basement which does not require new construction or any additions to the existing structure.

- (d) *Access. An accessory apartment shall have a minimum of one separate external door access from the principal dwelling located on either the side or the rear of the principal dwelling.*

Access to the accessory apartment is through an external door at the rear of the principal dwelling.

- (e) *Amenities. An accessory apartment shall contain separate amenities from the principal dwelling: kitchen facilities, full bath, electric panel with separate disconnect, telephone service.*

The proposed accessory apartment is a studio apartment complete with living area, full bathroom, and kitchen separate from the principal dwelling, as shown on Exhibit C.

- (f) *Parking. In addition to the two parking spaces required for the principal dwelling, two off-street parking spaces shall be provided for an accessory apartment in a designated location on the premises. Such spaces shall be on an area prepared to accommodate vehicle parking. In the Ogden Valley Destination and Resort Zone, this requirement shall be subject to modification by an approved parking plan pursuant to section 108-8-13.*

The proposal includes up to three off street parking spaces, as shown on the Exhibit C.

Given the demonstrated compliance with the above criteria, the Planning Division anticipates no detrimental effects to the site or surrounding areas.

Review Agencies: The Fire District and Engineering division have given approval of the project.

Western Weber Planning Commission Recommendation

In order for a conditional use to be approved it must meet the requirements of applicable ordinances listed in this staff report, which include the requirements listed in LUC §108-4-4, under "Decision Requirements", which states:

a) A conditional use shall be approved if reasonable conditions are proposed, or can be imposed, to substantially mitigate the reasonably anticipated detrimental effects of the proposed use in accordance with the standards of this chapter, or relevant standards or requirements of any other chapter of this Land Use Code. When considering any of the standards, the land use authority shall consider the reasonably anticipated detrimental effects of the proposed use in the context of current conditions and, to the extent supported by law, the policy recommendations of the applicable general plan.

b) If the reasonably anticipated detrimental effects of a proposed conditional use cannot be substantially mitigated by the proposal or the imposition of reasonable conditions to achieve compliance with applicable standards, the conditional use may be denied.

The Planning Commission will need to determine if the request for an accessory apartment has met the requirements of the applicable Uniform Land Use Code of Weber County. The Planning Commission may impose additional conditions in order to ensure full compliance with the required standards. In making a decision, the Planning Commission should consider the following questions:

- Does the submittal meet the Uniform Land Use Code of Weber County? If no, then what conditions could be added in order to comply?
- Have the "Decision Requirements" and other applicable ordinances been met?

Staff Recommendation

In addition to any Western Weber Planning Commission recommendations of approval, the Planning Division recommends the following additional conditions of approval:

1. The applicant will need to submit an addendum to their open building permit for the single-family home and have it approved through the Building Department.
2. The accessory apartment shall have a separate electric panel with separate disconnect.
3. Either the principal dwelling or accessory apartment shall be occupied by the owner of the premises at all times, excepting reasonable vacation absences.
4. Upon receipt of a conditional use permit, and prior to issuance of a certificate of occupancy by the chief building official, the county zoning enforcement officer shall inspect the premises.
5. An issued conditional use permit shall be reviewed for renewal every two years.
6. Per Sec. 108-19-5 of the Land Use Code, and prior to the issuance of a certificate of occupancy, the owner shall provide a copy of the initial rental agreement indicating either the monthly or annual rent of the unit. Rental agreements shall be reviewed every two years with the CUP renewal in order to assure that the affordability of the accessory apartment is upheld and to keep records on numbers and availability of affordable housing.

This recommendation is based on the following findings:

1. The proposed use as proposed, will not be detrimental to public health, safety, or welfare.
2. The proposed use, as proposed complies with applicable County ordinances.
3. The proposed use will not deteriorate the environment of the general area so as to negatively impact surrounding properties and uses.

Exhibits

- A. Project Application & Narrative
- B. Feasibility Letters (Water & Sewer)
- C. Accessory Apartment Plan

Location Map

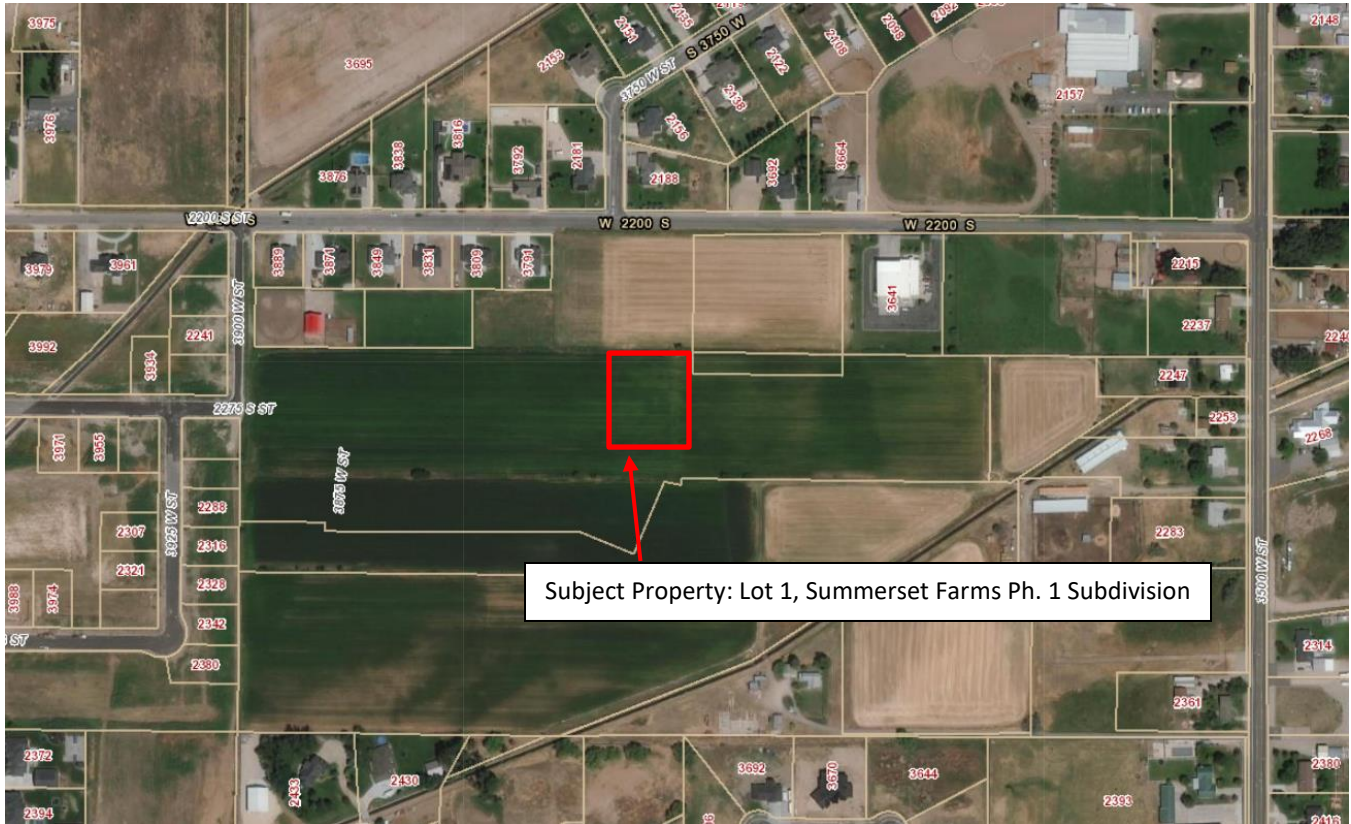

Weber County Conditional Use Permit Application			
Application submittals will be accepted by appointment only. (801) 399-8791. 2380 Washington Blvd. Suite 240, Ogden, UT 84401			
Date Submitted / Completed 10/26/2020	Fees (Office Use)	Receipt Number (Office Use)	File Number (Office Use)
Property Owner Contact Information			
Name of Property Owner(s) Dale McCrary		Mailing Address of Property Owner(s) 2313 w 1700 S Syracuse, Utah 84075	
Phone 801-675-0691	Fax NA		
Email Address (required) dmccrar@yahoo.com		Preferred Method of Written Correspondence <input checked="" type="checkbox"/> Email <input type="checkbox"/> Fax <input type="checkbox"/> Mail	
Authorized Representative Contact Information			
Name of Person Authorized to Represent the Property Owner(s)		Mailing Address of Authorized Person	
Phone	Fax		
Email Address		Preferred Method of Written Correspondence <input type="checkbox"/> Email <input type="checkbox"/> Fax <input type="checkbox"/> Mail	
Property Information			
Project Name Dale McCrary		Total Acreage 1.10	Current Zoning R-1
Approximate Address 2259 S 3750 W Taylor, Utah 84401 <i>(Lot 1 Summerset)</i>		Land Serial Number(s) 15-724-0001	
Proposed Use Rental of Basement			
Project Narrative i would like to Rent out a portion of my Basement, this rental will provide someone a safe enviroment and quit town to live in. They will be 10 min from the Freeway and close to the heart of Ogden. The Basement apartment will be approx. 800' sq ft of living space. They will have their own parking which will be located by their entrance. This apartment will be new with quality appliances, cabinetry and flooring. This apartment will be a place they tenent would be proud to call home.			

Basis for Issuance of Conditional Use Permit

Reasonably anticipated detrimental effects of a proposed conditional use can be substantially mitigated by the proposal or by the imposition of reasonable conditions to achieve compliance with applicable standards. Examples of potential negative impacts are odor, vibration, light, dust, smoke, or noise.

This Conditional Permit request won't have any of the negative impacts listed above.

That the proposed use will comply with the regulations and conditions specified in the Zoning Ordinance and other applicable agency standards for such use.

Yes, everything associated with the apartment will be in compliance with Weber County's Zoning

Property Owner Affidavit

I (We), Dale McCrary, depose and say that I (we) am (are) the owner(s) of the property identified in this application and that the statements herein contained, the information provided in the attached plans and other exhibits are in all respects true and correct to the best of my (our) knowledge.

Dale McCrary

(Property Owner)

(Property Owner)

Subscribed and sworn to before me this 16 day of August, 2020



AMT

(Notary)

Authorized Representative Affidavit

I (We), _____, the owner(s) of the real property described in the attached application, do authorized as my (our) representative(s), _____, to represent me (us) regarding the attached application and to appear on my (our) behalf before any administrative or legislative body in the County considering this application and to act in all respects as our agent in matters pertaining to the attached application.

(Property Owner)

(Property Owner)

Dated this _____ day of _____, 20 _____, personally appeared before me _____, the signer(s) of the Representative Authorization Affidavit who duly acknowledged to me that they executed the same.

(Notary)



2815 WEST 3300 SOUTH
WEST HAVEN, UTAH 84401
801-731-1668
11/3/2020

Weber County Planning Commission
2380 Washington Boulevard
Ogden, Utah 84401

To Whom It May Concern:

This is to inform you that ***preliminary*** approval has been given and the District has the capacity to provide culinary water only for a conditional use apartment at the approximate address 2259 S. 3750 W. Taylor, Utah.

Requirements:

- All requirements have previously been met.
- Taylor West Weber Water District reserves the right to make or revise changes as needed or as advised by the district engineer or the district attorney.
- Final approval is subject to meeting all of the requirements of the District and all fees being paid and received. This letter expires six months from the date it is issued.

Expires 5/3/2021

Sincerely, 

Ryan Rogers – Manager
Taylor West Weber Water Improvement District



Central Weber Sewer Improvement District

November 3, 2020

Scott Perkes
Weber County Planning Commission
2380 Washington Blvd #240, Ogden, UT 84401

SU: Will Serve Letter Request, 2259 South 3750 West, Taylor, UT

Scott,

Mr. Dale McCrary has requested a will serve letter for incorporating an apartment into the basement of his home located at 2259 South 3750 West, Taylor (Weber County) Utah. The home is reported to be currently under construction and connection made to the sewer service already with proper approvals. We offer the following comments regarding Central Weber providing sanitary sewer service.

1. Central Weber has the capacity to treat the sanitary sewer flow from this apartment.
2. No additional connection is anticipated to the sewer system. If any connection is made directly into Central Weber's line the connection must be inspected by Central Weber while the work is being done. A minimum of 48 hour notice for inspection shall be given to Central Weber prior to any work associated with the connection.
3. Central Weber will not take ownership or responsibility for the condition, ownership or maintenance of the proposed sanitary sewer lines (gravity or pressure) or system that will be installed to serve this subdivision.
4. The connection of any sump pumps (or similar type pumps) to the sanitary sewer system is prohibited during or after construction. Central Weber's Wastewater Control Rules and Regulations state:

Prohibited Discharge into Sanitary Sewer. No person shall discharge or cause or make a connection which would allowed to be discharged any storm water, surface water, groundwater, roof water runoff or subsurface drainage to any sanitary sewer.

5. It is our understanding that the parcel has been annexed into Central Weber Sewer Improvement District.
6. Impact fees will need to be paid to Central Weber Sewer Improvement District no later than the issuance of any building permits.

If you have any further questions or need additional information please let us know.

Sincerely,



Kevin Hall, P. E.
General Manager

cc: Chad Meyerhoffer, Weber County
Dale McCrary
Steve Burton Weber County

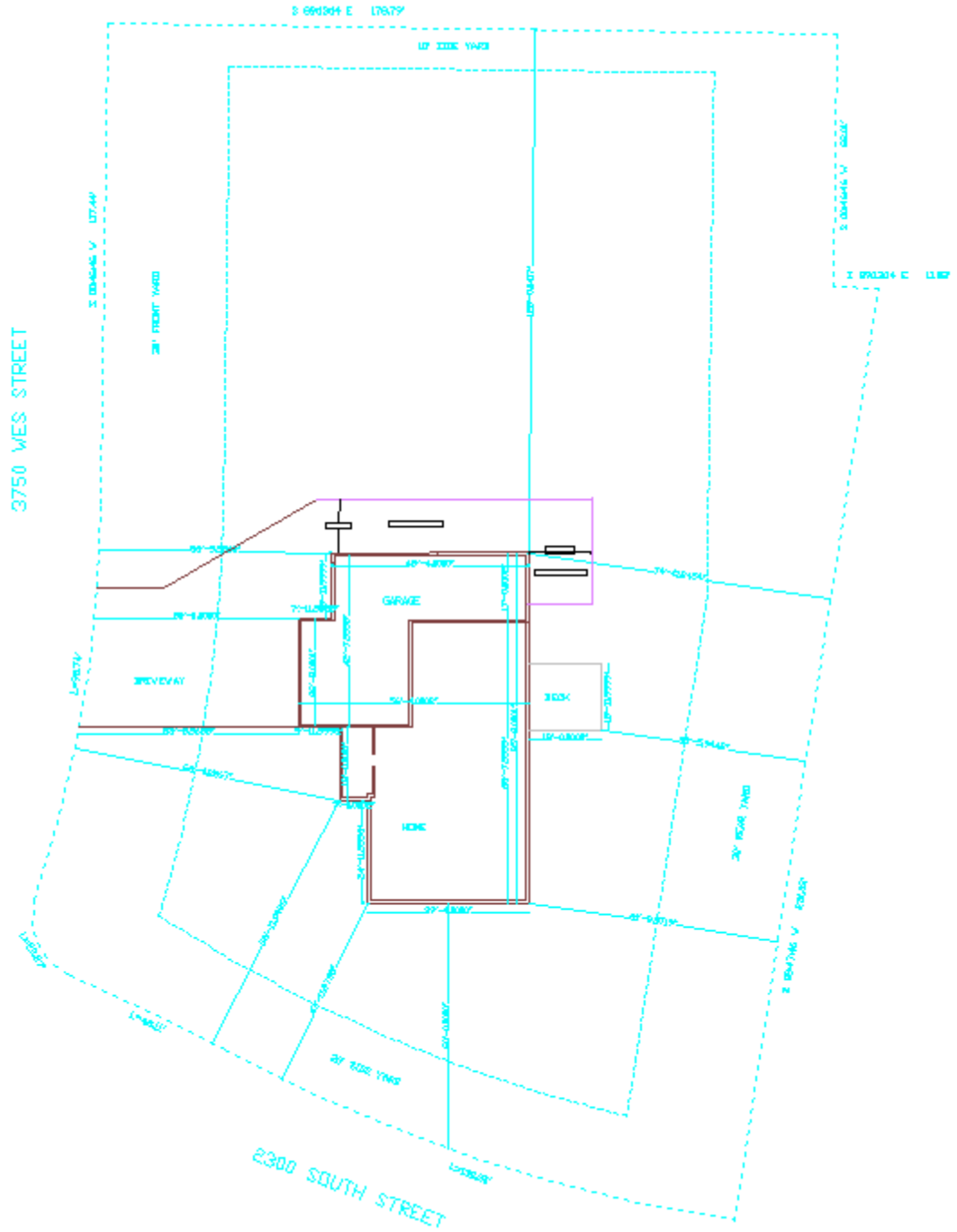

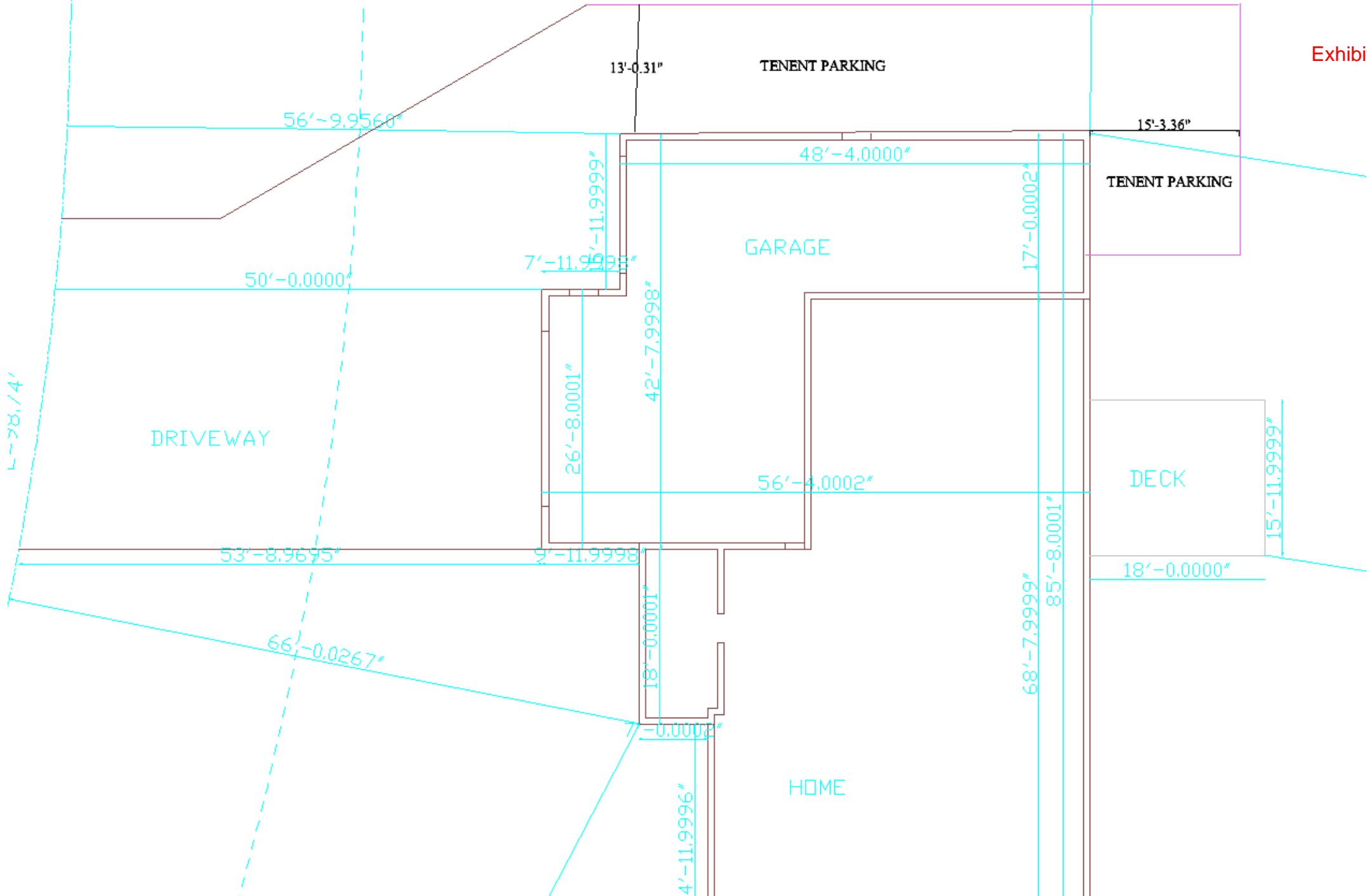

<p>PLAN NOTES</p>		<p>Homesites Dale McCreary 801.275-0882</p>
<p>FINISH</p> <p>1. EXTERIOR WALLS: BRICK</p> <p>2. EXTERIOR ROOF: ASPH/FLT</p> <p>3. EXTERIOR FLOORING: VINYL</p> <p>4. EXTERIOR PAINT: WHITE</p> <p>5. INTERIOR WALLS: DRYWALL</p> <p>6. INTERIOR FLOORING: CARPET</p> <p>7. INTERIOR PAINT: WHITE</p> <p>8. INTERIOR CEILING: POP</p> <p>9. INTERIOR DOORS: WOOD</p> <p>10. INTERIOR WINDOWS: WOOD</p> <p>11. INTERIOR STAIRS: WOOD</p> <p>12. INTERIOR LIGHTS: RECESSED</p> <p>13. INTERIOR SINKS: STAINLESS</p> <p>14. INTERIOR TUBS: ACRYLIC</p> <p>15. INTERIOR CABS: WOOD</p> <p>16. INTERIOR COUNTERTOPS: QUARTZ</p> <p>17. INTERIOR APPLIANCES: STAINLESS</p> <p>18. INTERIOR GRILLS: STAINLESS</p> <p>19. INTERIOR SMOOTHS: WOOD</p> <p>20. INTERIOR TRIM: WOOD</p>	<p>Right Elevation</p>	<p>General Construction</p>
<p>FOUNDATION</p> <p>1. CONCRETE</p> <p>2. BRICK</p> <p>3. BLOCK</p> <p>4. CMU</p> <p>5. CMU</p> <p>6. CMU</p> <p>7. CMU</p> <p>8. CMU</p> <p>9. CMU</p> <p>10. CMU</p> <p>11. CMU</p> <p>12. CMU</p> <p>13. CMU</p> <p>14. CMU</p> <p>15. CMU</p> <p>16. CMU</p> <p>17. CMU</p> <p>18. CMU</p> <p>19. CMU</p> <p>20. CMU</p>		<p>McCreary Residence Lot 4, Summerdale Farms 2200 South 3700 West Taylors, Utah</p>
<p>Front Elevation</p>	<p>Front Elevation</p>	<p>CREATIVE LINE ARCHITECTURE 1000 N. 1000 E. SALT LAKE CITY, UT 84143 801.488.1111 www.creative-line.com</p>

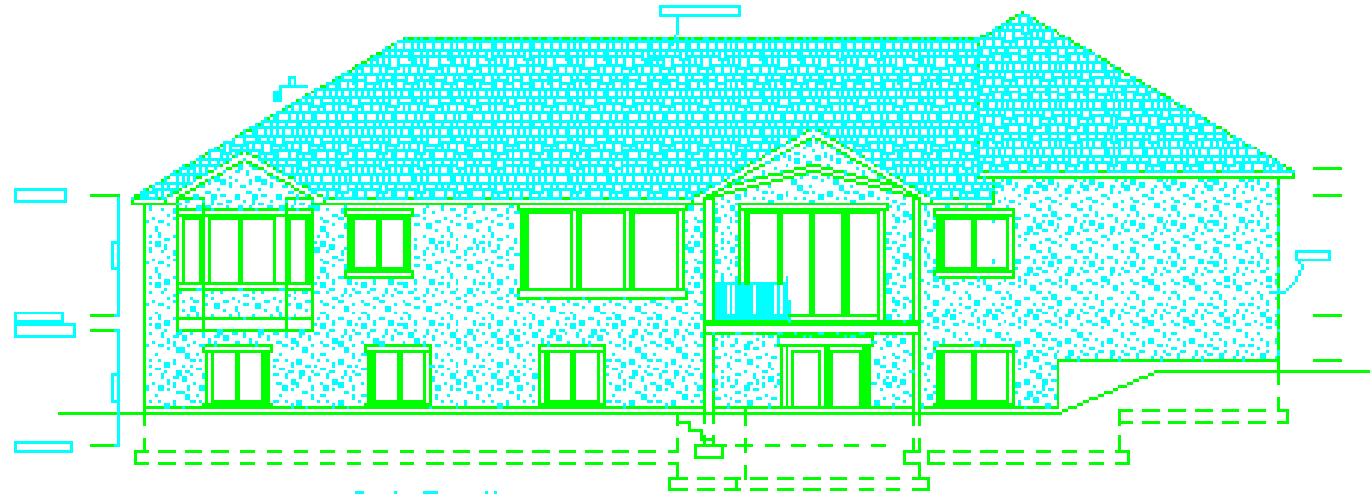

Back Elevation

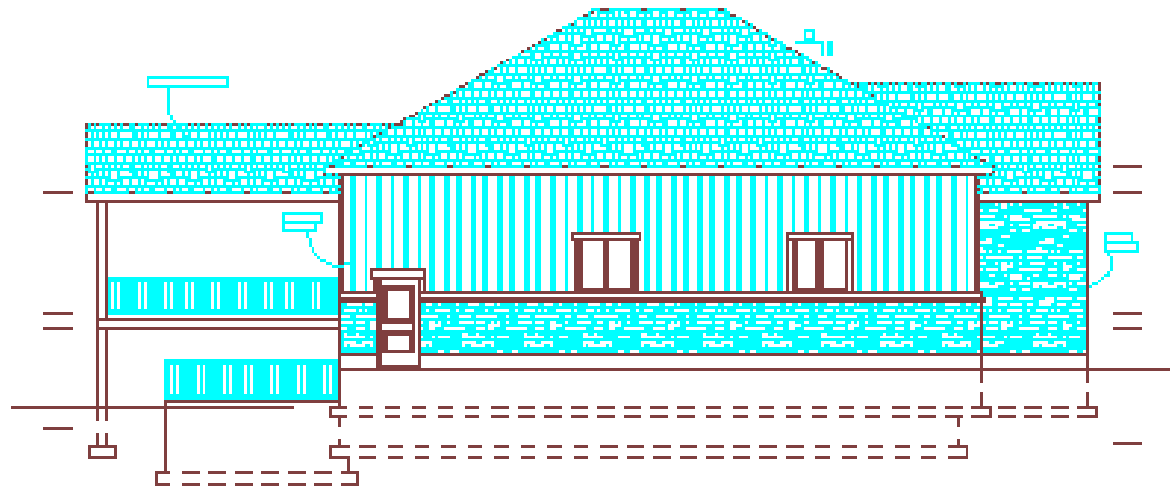

Left Elevation

DATE: 10/20/2011 2:10:00 PM

VERSION:

Prepared by:
Mike McCrory
BIT: 675-0887

General Contractor:

McCrory RESIDENCE
Lot #1, Summer Farm
2299 South 3700 West
Taylor, Utah

BIT
2011 ELEVATIONS

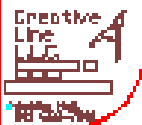

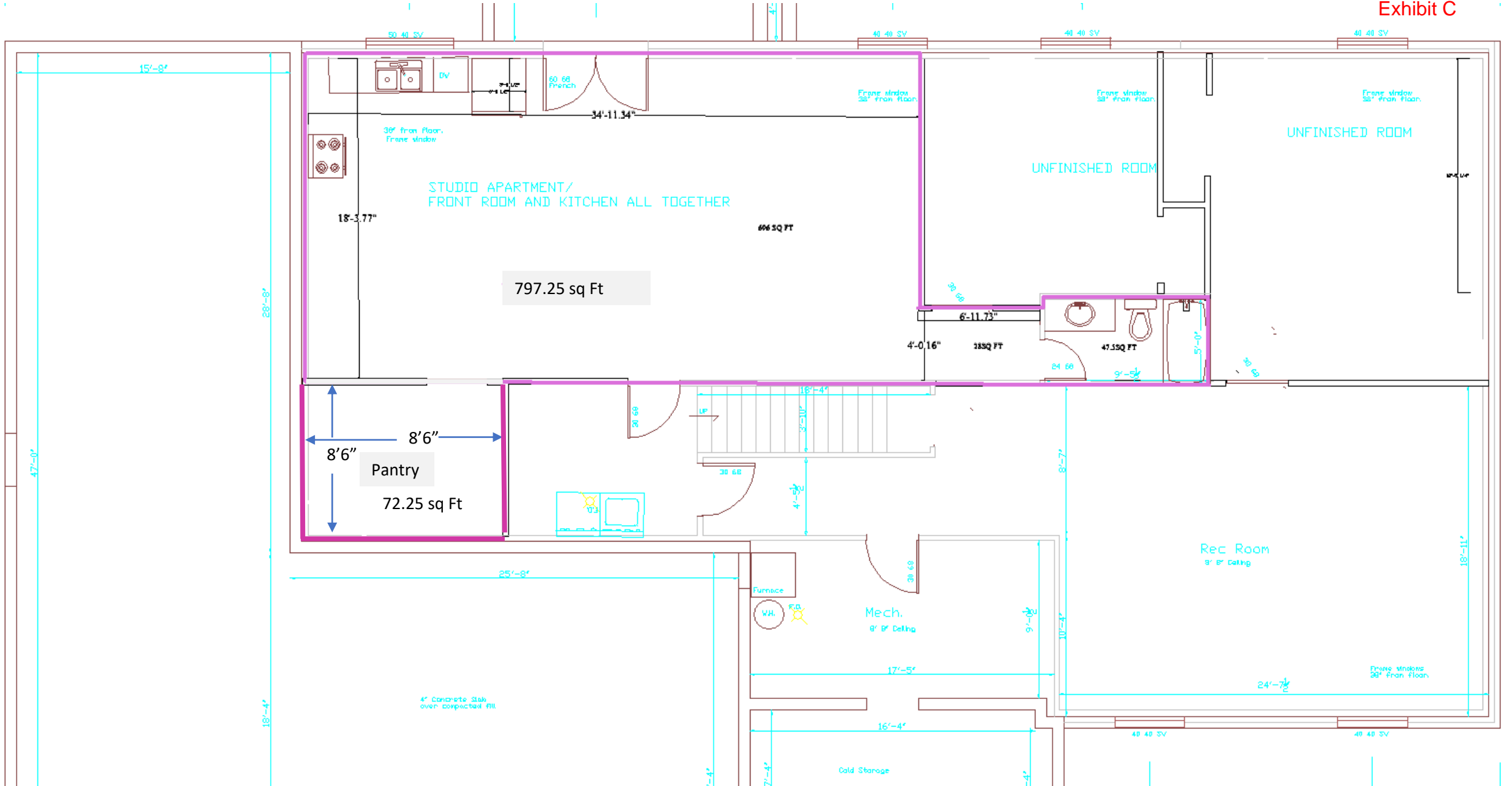



Staff Report to the Western Weber Planning Commission

Weber County Planning Division

Synopsis

Application Information

Application Request:	Consideration and action on a request for final approval of Sun Crest Meadows Subdivision Phase 3.
Type of Decision:	Administrative
Agenda Date:	Tuesday, December 8, 2020
Applicant:	Carson Jones
File Number:	LVS102220

Property Information

Approximate Address:	2550 S 4700 W, Taylor, UT
Project Area:	10.13 acres
Zoning:	A-1
Existing Land Use:	Agricultural
Proposed Land Use:	Residential
Parcel ID:	15-086-0018
Township, Range, Section:	Township 6 North, Range 2 West, Section 32

Adjacent Land Use

North:	Residential (Phase 1)	South:	Agricultural
East:	Residential	West:	Residential/Agricultural

Staff Information

Report Presenter:	Steve Burton sburton@co.weber.ut.us 801-399-8766
Report Reviewer:	RG

Applicable Ordinances

- Title 104, Zones, Chapter 5, Agricultural (A-1) Zone
- Title 104, Zones, Chapter 7, Agricultural (A-2) Zone
- Title 106, Subdivisions

Background

The applicants are requesting final approval of Sun Crest Meadows Subdivision Phase 3, consisting of 9 lots. Preliminary approval of the entire phasing plan of the subdivision, consisting of 47 lots, was granted by the Planning Commission on February 21, 2017. As part of the subdivision review process, the proposal has been reviewed against the subdivision ordinance and the standards in the A-1 zone. With the recommended conditions, the proposal complies with the applicable standards.

Analysis

General Plan: The proposal conforms to the Western Weber General Plan by creating lots for the continuation of single-family residential development that is currently dominant in the area.

Zoning: The subject property is located in the Agriculture (A-1) zone. The purpose of the Agricultural (A-1) zone is identified in the LUC §104-5-1 as:

The purpose of the A-1 Zone is to designate farm areas, which are likely to undergo a more intensive urban development, to set up guidelines to continue agricultural pursuits, including the keeping of farm animals, and to direct orderly low-density residential development in a continuing rural environment.

Culinary water and sanitary sewage disposal: Will Serve letters have been provided by the Taylor West Weber Water Improvement District and the Central Weber Sewer Improvement District regarding culinary water and sanitary sewer disposal. Hooper Irrigation Company has also provided a Will Serve letter regarding secondary water.

Additional design standards and requirements: A guarantee of Improvements will be required as outlined in LUC § 106-4-3. As part of the conditions of preliminary approval, the applicant is required to install curb, gutter, and sidewalk along both sides of the existing and proposed streets.

Review Agencies: To date, the proposed subdivision has been reviewed by the Engineering Division, Surveyor's Office, and the Fire District. A condition of approval has been added to ensure that all conditions of the Review Agencies will be addressed prior to the recording of the final mylar.

Tax clearance: There are no outstanding tax payments currently related to these parcels.

Staff Recommendation

Staff recommends final approval of the Sun Crest Meadows Phase 3. This recommendation for approval is subject to all review agency requirements and based on the following conditions:

1. A guarantee of Improvements will be required as outlined in LUC § 106-4-3.

This recommendation is based on the following findings:

1. The proposed subdivision conforms to the Western Weber General Plan.
2. With the recommended conditions, the proposed subdivision complies with applicable County ordinances.

Exhibits

- A. Phase 3 final plat
- B. Preliminary plan

Area Map

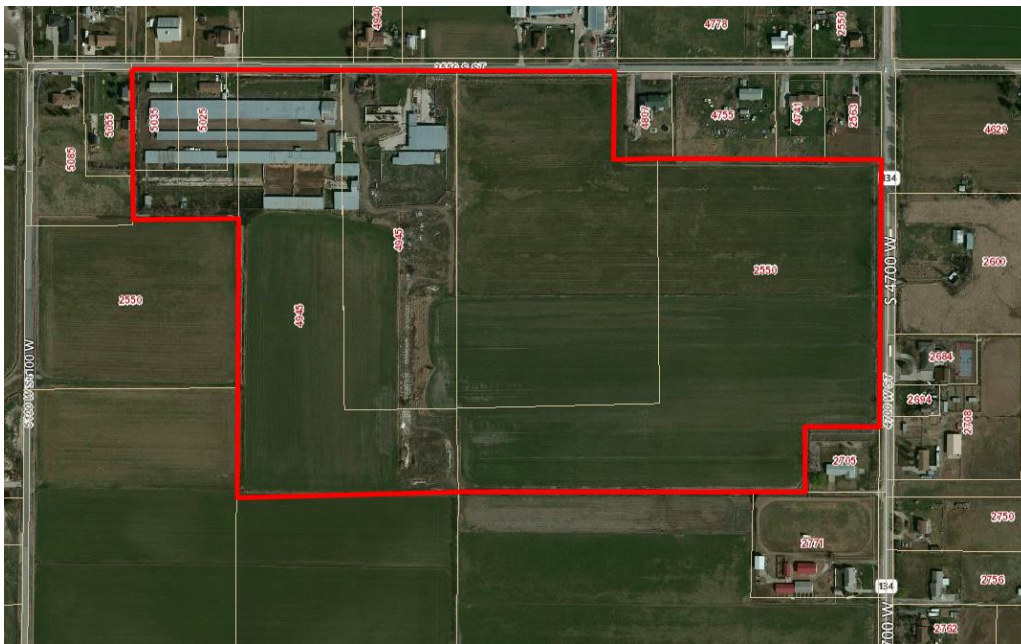

SUNCREST MEADOWS SUBDIVISION - PH3

LOCATED IN THE NORTHWEST QUARTER OF SECTION 32,
TOWNSHIP 6 NORTH, RANGE 2 WEST, SALT LAKE BASE AND MERIDIAN,
WEBER COUNTY, UTAH

MONTH 2020

VICINITY MAP

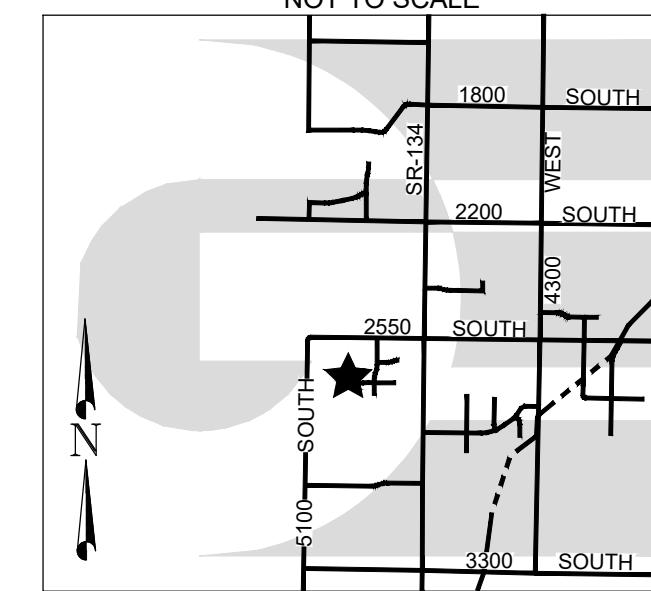

BOUNDARY DESCRIPTION

A PART OF THE NORTHWEST QUARTER OF SECTION 32, TOWNSHIP 6 NORTH, RANGE 2 WEST OF THE SALT LAKE BASE AND MERIDIAN, MORE PARTICULARLY DESCRIBED AS FOLLOWS: BEGINNING AT POINT BEING LOCATED NORTH 89°06'33" WEST 1362.64 FEET ALONG THE NORTH SECTION LINE OF SAID SECTION 32 AND SOUTH 00°41'00" WEST 523.02 FEET ALONG THE WEST BOUNDARY LINE OF SUNCREST MEADOWS SUBDIVISION PHASE 1 FROM THE NORTH QUARTER CORNER OF SAID SECTION 32, RUNNING THENCE ALONG THE SAID WEST BOUNDARY LINE OF SUNCREST MEADOWS SUBDIVISION PHASE 1 THE FOLLOWING TWO (2) COURSES: (1) SOUTH 00°41'00" WEST 120.69 FEET; (2) SOUTH 09°58'17" WEST 149.64 FEET TO THE NORTH BOUNDARY LINE OF SUNCREST MEADOWS SUBDIVISION PHASE 2; THENCE ALONG SAID NORTH BOUNDARY LINE NORTH 89°19'00" WEST 127.98 FEET TO THE WEST BOUNDARY LINE OF SAID SUNCREST MEADOWS SUBDIVISION PHASE 2; THENCE ALONG SAID WEST BOUNDARY LINE OF SAID SUNCREST MEADOWS SUBDIVISION PHASE 2 SOUTH 01°07'57" WEST 288.76 FEET TO THE SOUTH RIGHT-OF-WAY LINE OF 2700 SOUTH STREET; THENCE ALONG SAID SOUTH RIGHT-OF-WAY LINE ALONG THE ARC OF A 1030.00 FOOT RADIUS CURVE TO THE LEFT 50.41 FEET, HAVING A CENTRAL ANGLE OF 02°48'15" CHORD BEARS NORTH 85°57'46" EAST 50.41 FEET; THENCE ALONG SAID WEST BOUNDARY LINE OF SUNCREST MEADOWS SUBDIVISION PHASE 2 SOUTH 00°39'30" WEST 246.83 FEET; THENCE NORTH 89°07'34" WEST 517.87 FEET; THENCE NORTH 00°43'56" EAST 818.73 FEET; THENCE SOUTH 89°06'44" EAST 282.77 FEET; THENCE SOUTH 71°53'53" EAST 62.31 FEET; THENCE SOUTH 89°06'44" EAST 279.01 FEET TO THE POINT OF BEGINNING, CONTAINING 9.915 ACRES.

SURVEYOR'S CERTIFICATE

I, KLINT H. WHITNEY, DO HEREBY CERTIFY THAT I AM A LICENSED PROFESSIONAL LAND SURVEYOR IN THE STATE OF UTAH AND THAT I HOLD CERTIFICATE NO. 8227228 IN ACCORDANCE WITH TITLE 58, CHAPTER 22, OF THE PROFESSIONAL ENGINEERS AND LAND SURVEYORS ACT; I FURTHER CERTIFY THAT BY AUTHORITY OF THE OWNERS I HAVE COMPLETED A SURVEY OF THE PROPERTY AS SHOWN AND DESCRIBED ON THIS PLAT, AND HAVE SUBDIVIDED SAID PROPERTY INTO LOTS AND STREETS, TOGETHER WITH EASEMENTS, HEREAFTER TO BE KNOWN AS SUNCREST MEADOWS SUBDIVISION - PH3 IN ACCORDANCE WITH SECTION 17-23-17 AND HAVE VERIFIED ALL MEASUREMENTS; THAT THE REFERENCE MONUMENTS SHOWN HEREON ARE LOCATED AS INDICATED AND ARE SUFFICIENT TO RETRACE OR REESTABLISH THIS SURVEY; THAT ALL LOTS MEET THE REQUIREMENTS OF THE LAND USE CODE; AND THAT THE INFORMATION SHOWN HEREIN IS SUFFICIENT TO ACCURATELY ESTABLISH THE LATERAL BOUNDARIES OF THE HEREIN DESCRIBED TRACT OF REAL PROPERTY.

SIGNED THIS _____ DAY OF _____, 2020.

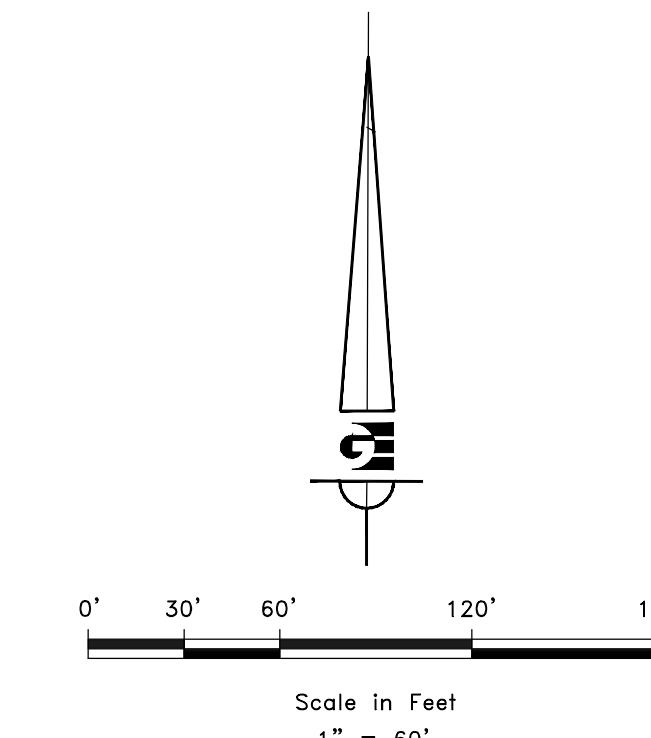
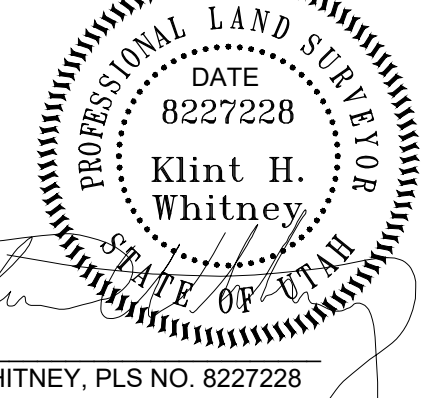

LEGEND

- ◆ WEBER COUNTY MONUMENT AS NOTED
- SET 24" REBAR AND CAP MARKED GARDNER ENGINEERING
- SUBDIVISION BOUNDARY
- LOT LINE
- - - ADJACENT PARCEL
- - - SECTION LINE
- - - EASEMENT
- - - EXISTING FENCE

CURVE TABLE

CURVE #	LENGTH	RADIUS	DELTA	CHORD BEARING	CHORD LENGTH
C1	184.07	500.00	21.09	S13° 02' 25"W	183.04
C2	198.09	500.00	22.70	S12° 14' 15"W	196.79
C3	63.46	1000.00	3.64	N89° 04' 11"E	63.45
C4	63.33	1030.00	3.52	N89° 07' 35"E	63.32
C6	58.78	530.00	6.35	N4° 03' 54"E	58.75
C7	31.69	470.00	3.86	N21° 39' 19"E	31.69
C8	151.19	530.00	16.34	N15° 24' 53"E	150.68
C9	149.74	470.00	18.25	N10° 35' 47"E	149.10
C10	157.00	530.00	16.97	N11° 53' 02"E	156.42
C11	126.51	470.00	15.42	N15° 52' 34"E	126.13
C12	29.76	530.00	3.22	N21° 58' 43"E	29.75
C13	63.59	970.00	3.76	S89° 00' 35"W	63.58
C14	59.70	470.00	7.28	N4° 31' 35"E	59.66

NOTES

- SUBJECT PROPERTY FALLS WITHIN FEMA FLOOD ZONE "X" - AREAS DETERMINED TO BE OUTSIDE THE 0.2% ANNUAL CHANCE FLOODPLAIN. PER MAP NO. 49057C0401E WITH EFFECTIVE DATE OF DECEMBER 16, 2005.
- ZONE RE-20 YARD SETBACKS: 30' FRONT // 30' REAR // 10' SIDE WITH 24' COMBINED SIDEYARD
- HOMEOWNERS ARE REFERRED TO THE GEOTECHNICAL STUDY PREPARED FOR THE SUNCREST MEADOWS SUBDIVISION BY CMT ENGINEERING LABORATORIES DATED MARCH 27, 2018 CMT PROJECT NO. 10830. SUBDIVISION IMPROVEMENTS AND HOMEOWNERS ARE REQUIRED TO COMPLY WITH SAID STUDY. ACCORDING TO THE GEOTECHNICAL REPORT, ANY NON-ENGINEERED FILL NEEDS TO BE REMOVED UNDERNEATH ANY BUILDING STRUCTURE. IT IS RECOMMENDED THAT THE GEOTECHNICAL ENGINEER OBSERVE THE EXCAVATION FOR THE HOMES IN ORDER TO VERIFY THAT THE NON-ENGINEERED FILL HAS BEEN REMOVED.
- 10.0' WIDE PUBLIC UTILITY AND DRAINAGE EASEMENTS EACH SIDE OF PROPERTY LINES AS INDICATED BY DASHED LINES UNLESS NOTED OTHERWISE.
- AGRICULTURE IS THE PREFERRED USE IN THE AGRICULTURE ZONES. AGRICULTURE OPERATIONS AS SPECIFIED IN THE ZONING ORDINANCE FOR A PARTICULAR ZONE ARE PERMITTED AT ANY TIME INCLUDING THE OPERATION OF FARM MACHINERY AND NO ALLOWED AGRICULTURE USE SHALL BE SUBJECT TO RESTRICTION ON THAT IT INTERFERES WITH ACTIVITIES OF FUTURE RESIDENTS OF THIS SUBDIVISION.

NARRATIVE

THE PURPOSE OF THIS SURVEY WAS TO CREATE A NINE LOT SUBDIVISION ON THE PROPERTY AS SHOWN AND DESCRIBED HEREON. THE SURVEY WAS ORDERED BY BLACKBURN JONES. THE CONTROL USED TO ESTABLISH THE BOUNDARY WAS THE EXISTING WEBER COUNTY SURVEY MONUMENTATION AS SHOWN AND NOTED HEREON. THE BASIS OF BEARING IS THE NORTH LINE OF THE NORTHEAST QUARTER OF SECTION 16, TOWNSHIP 6 NORTH, RANGE 2 WEST, OF THE SALT LAKE BASE AND MERIDIAN WHICH BEARS NORTH 89°26'19" WEST WEBER COUNTY, UTAH NORTH, NAD 83 STATE PLANE GRID BEARING. WARRANTY DEEDS RECORDED AS ENTRY NUMBERS 2936519, 2936521 AND DEEDS A JOINING PROPERTIES. THE DEDICATED PLATS OF SUNCREST MEADOWS SUBDIVISION PHASE 1 AND 2 WERE ALSO USED TO DETERMINE THE BOUNDARY.

OWNER'S DEDICATION

I THE UNDERSIGNED OWNER OF THE HEREON DESCRIBED TRACT OF LAND, HEREBY SET APART AND SUBDIVIDE THE SAME INTO LOTS, PARCELS AND STREETS AS SHOWN ON THIS PLAT AND NAME SAID TRACT:

SUNCREST MEADOWS SUBDIVISION PHASE 3

AND HEREBY DEDICATE, GRANT AND CONVEY TO WEBER COUNTY, UTAH ALL THOSE PARTS OR PORTIONS OF SAID TRACT OF LAND DESIGNATED AS STREETS, TOGETHER WITH EASEMENTS, HEREAFTER TO BE KNOWN AS PUBLIC UTILITY, THE SAME TO BE USED FOR THE INSTALLATION, MAINTENANCE AND OPERATION OF PUBLIC UTILITY SERVICE LINES, STORM DRAINAGE FACILITIES OR FOR THE PERPETUAL PRESERVATION OF WATER DRAINAGE CHANNELS IN THEIR NATURAL STATE WHICHEVER IS APPLICABLE AS MAY BE AUTHORIZED BY WEBER COUNTY, UTAH, WITH NO BUILDINGS OR STRUCTURES BEING ERIGED WITHIN SAID EASEMENTS.

SIGNED THIS _____ DAY OF _____, 2020.

SUNCREST MEADOWS - WEBER, LLC BY:

BLACKBURN JONES REAL ESTATE INCORPORATED, MANAGER OF SUNCREST MEADOWS - WEBER, LLC

CARSON E. JONES, DIRECTOR OF BLACKBURN JONES REAL ESTATE INCORPORATED

ACKNOWLEDGEMENT

STATE OF UTAH)
COUNTY OF WEBER)

On this _____ day of _____, 2020, personally appeared before me CARSON E. JONES, whose identity is personally known to me (or proven on the basis of satisfactory evidence) and who by me duly sworn/affirmed, did say that he/she is the DIRECTOR OF BLACKBURN JONES REAL ESTATE INCORPORATED, MANAGER OF SUNCREST MEADOWS - WEBER, LLC, and that said document was signed by him/her in behalf of said Corporation by Authority of its Bylaws, or (Resolution of its Board of Directors), and said CARSON E. JONES acknowledged to me that said Corporation executed the same.

STAMP

NOTARY PUBLIC

DEVELOPER: BLACKBURN JONES CARSON JONES 905 24TH STREET OGDEN, UTAH 84404 (801) 778-0088	S1 1	COUNTY RECORDER ENTRY NO. _____ FEE PAID _____ FILED FOR AND RECORDED _____ AT _____ IN BOOK _____ OF OFFICIAL _____ RECORDS, PAGE _____, RECORDED _____ FOR _____ COUNTY RECORDER BY: _____
GARDNER ENGINEERING CIVIL - LAND PLANNING MUNICIPAL - LAND SURVEYING		
5150 SOUTH 375 EAST OGDEN, UT OFFICE: 801.476.0202 FAX: 801.476.0066		

NORTHEAST COR SECTION 32,
T6N, R2W, S16, & M. (FOUND WEBER
COUNTY BRASS CAP MONUMENT)

NORTH QUARTER COR SECTION 32,
T6N, R2W, S16, & M. (FOUND WEBER
COUNTY BRASS CAP MONUMENT)

REMAINDER PARCEL NOT APPROVED
FOR DEVELOPMENT AT THIS TIME

SUNCREST MEADOWS WEBER LLC
150860029

SUNCREST MEADOWS WEBER LLC
150860035

SUNCREST MEADOWS WEBER LLC
150860037

FLITTON, BRACKIN &
WF TAYLOR FLITTON
156760009

FRANCOM, LYLE &
WF JANA FRANCOM
156760010

FARR BUILT HOMES INC
156760010

HOTCHKISS HOMES INC
157070002

PORTER, STEPHEN L &
SHELLY K PORTER
157070001

STOKES, DOUGLAS T &
WF VENETA STOKES
157070009

MILLER KARI & WF
SHARI MILLER
157070008

THOMPSON, RICHARD Z &
WF KAREN S THOMPSON
150860006

FAVERO, THOMAS V &
DAVID E FAVERO
150860011

FAVERO FARMS LC
150860010

FAVERO FARMS LC
150860012

WEBER COUNTY SURVEYOR

I HEREBY CERTIFY THAT THE WEBER COUNTY SURVEYOR'S OFFICE HAS REVIEWED THIS PLAT FOR MATHEMATICAL CORRECTNESS, SECTION CORNER DATA, AND FOR HARMONY WITH LINES AND MONUMENTS ON RECORD IN COUNTY OFFICES. THE APPROVAL OF THIS PLAT BY THE WEBER COUNTY SURVEYOR DOES NOT RELIEVE THE LICENSED LAND SURVEYOR WHO EXECUTED THIS PLAT FROM THE RESPONSIBILITIES AND/OR LIABILITIES ASSOCIATED THEREWITH.

SIGNED THIS _____ DAY OF _____, 2020.

WEBER COUNTY ATTORNEY

I HAVE EXAMINED THE FINANCIAL GUARANTEE AND OTHER DOCUMENTS ASSOCIATED WITH THIS SUBDIVISION PLAT AND IN MY OPINION THEY CONFORM WITH THE COUNTY ORDINANCE APPLICABLE THERETO AND NOW IN FORCE AND EFFECT.

SIGNED THIS _____ DAY OF _____, 2020.

WEBER COUNTY ENGINEER

I HEREBY CERTIFY THAT THE REQUIRED PUBLIC IMPROVEMENT STANDARDS AND DRAWINGS FOR THIS SUBDIVISION CONFORM WITH COUNTY STANDARDS AND THE AMOUNT OF THE FINANCIAL GUARANTEE IS SUFFICIENT FOR THE INSTALLATION OF THESE IMPROVEMENTS.

SIGNED THIS _____ DAY OF _____, 2020.

WEBER COUNTY COMMISSION ACCEPTANCE

THIS IS TO CERTIFY THAT THIS SUBDIVISION PLAT, THE DEDICATION OF STREETS AND OTHER PUBLIC WAYS AND FINANCIAL GUARANTEE OF PUBLIC IMPROVEMENTS ASSOCIATED WITH THIS SUBDIVISION THEREON ARE HEREBY APPROVED AND ACCEPTED BY THE COMMISSIONERS OF WEBER COUNTY, UTAH.

SIGNED THIS _____ DAY OF _____, 2020.

CHAIRMAN, WEBER COUNTY COMMISSION

WEBER COUNTY PLANNING COMMISSION APPROVAL

THIS IS TO CERTIFY THAT THIS SUBDIVISION WAS DULY APPROVED BY THE WEBER COUNTY PLANNING COMMISSION.

SIGNED THIS _____ DAY OF _____, 2020.

CHAIRMAN, WEBER COUNTY PLANNING COMMISSION

WEBER - MORGAN HEALTH DEPARTMENT

I DO HEREBY CERTIFY THAT THE SOILS, PERCOLATION RATES, AND SITE CONDITION FOR THIS SUBDIVISION HAVE BEEN INVESTIGATED BY THIS OFFICE AND ARE APPROVED FOR ON-SITE WASTEWATER DISPOSAL SYSTEMS.

SIGNED THIS _____ DAY OF _____, 2020.

DIRECTOR WEBER-MORGAN HEALTH DEPT.

SUN CREST MEADOWS

OVERALL PLAN (LOTS & DEDICATIONS)

2550 NORTH 4900 WEST – TAYLOR, UT 84401
NORTHWEST QUARTER OF SECTION 32, TOWNSHIP 6 NORTH,
RANGE 2 WEST, SALT LAKE BASE & MERIDIAN

DEVELOPER:
BLACKBURN JONES
905 24TH STREET
OGDEN, UTAH 84401
801-941-2018

ENGINEER/SURVEYOR:
HANSEN & ASSOCIATES, INC.
538 NORTH MAIN STREET
BRIGHAM CITY, UTAH 84302
435-723-3491

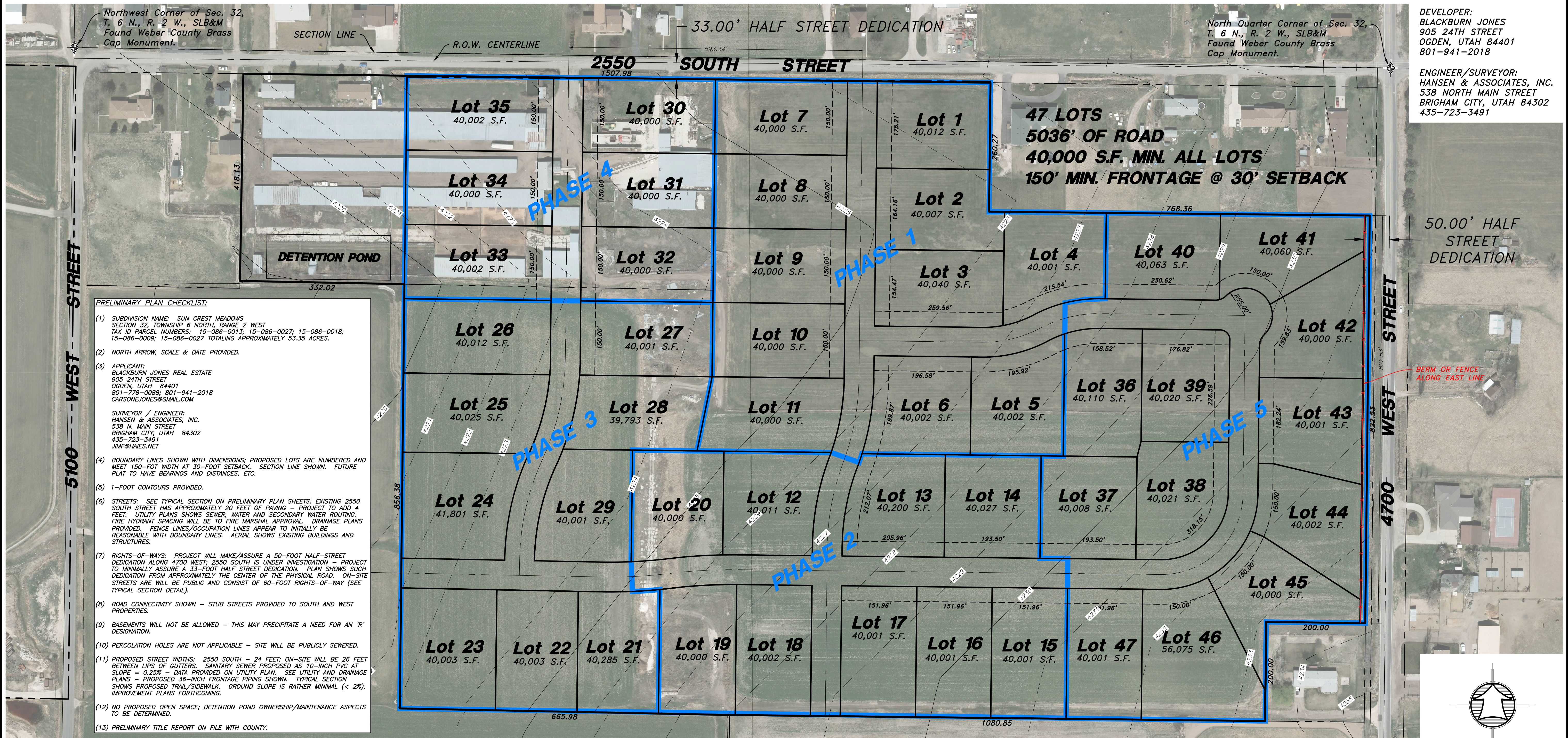

- PRELIMINARY PLAN CHECKLIST:**
- (1) SUBDIVISION NAME: SUN CREST MEADOWS SECTION 32, TOWNSHIP 6 NORTH, RANGE 2 WEST TAX ID PARCEL NUMBERS: 15-086-0013; 15-086-0027; 15-086-0018; 15-086-0009; 15-086-0027 TOTALING APPROXIMATELY 53.35 ACRES.
 - (2) NORTH ARROW, SCALE & DATE PROVIDED.
 - (3) APPLICANT: BLACKBURN JONES REAL ESTATE 905 24TH STREET OGDEN, UTAH 84401 801-778-0088; 801-941-2018 CARSONEJONES@GMAIL.COM SURVEYOR / ENGINEER: HANSEN & ASSOCIATES, INC. 538 N. MAIN STREET BRIGHAM CITY, UTAH 84302 435-723-3491 JIM@HAIES.NET
 - (4) BOUNDARY LINES SHOWN WITH DIMENSIONS; PROPOSED LOTS ARE NUMBERED AND MEET 150-FOOT WIDTH AT 30-FOOT SETBACK. SECTION LINE SHOWN. FUTURE PLAT TO HAVE BEARINGS AND DISTANCES, ETC.
 - (5) 1-FOOT CONTOURS PROVIDED.
 - (6) STREETS: SEE TYPICAL SECTION ON PRELIMINARY PLAN SHEETS. EXISTING 2550 SOUTH STREET HAS APPROXIMATELY 20 FEET OF PAVING – PROJECT TO ADD 4 FEET. UTILITY PLANS SHOWS SEWER, WATER AND SECONDARY WATER ROUTING. FIRE HYDRANT SPACING WILL BE TO FIRE MARSHAL APPROVAL. DRAINAGE PLANS PROVIDED. FENCE LINES/OCCUPATION LINES APPEAR TO INITIALLY BE REASONABLE WITH BOUNDARY LINES. AERIAL SHOWS EXISTING BUILDINGS AND STRUCTURES.
 - (7) RIGHTS-OF-WAYS: PROJECT WILL MAKE/ASSURE A 50-FOOT HALF-STREET DEDICATION ALONG 4700 WEST; 2550 SOUTH IS UNDER INVESTIGATION – PROJECT TO MINIMALLY ASSURE A 33-FOOT HALF STREET DEDICATION. PLAN SHOWS SUCH DEDICATION FROM APPROXIMATELY THE CENTER OF THE PHYSICAL ROAD. ON-SITE STREETS ARE WILL BE PUBLIC AND CONSIST OF 60-FOOT RIGHTS-OF-WAY (SEE TYPICAL SECTION DETAIL).
 - (8) ROAD CONNECTIVITY SHOWN – STUB STREETS PROVIDED TO SOUTH AND WEST PROPERTIES.
 - (9) BASEMENTS WILL NOT BE ALLOWED – THIS MAY PRECIPITATE A NEED FOR AN 'R' DESIGNATION.
 - (10) PERCOLATION HOLES ARE NOT APPLICABLE – SITE WILL BE PUBLICLY SEWERED.
 - (11) PROPOSED STREET WIDTHS: 2550 SOUTH – 24 FEET; ON-SITE WILL BE 26 FEET BETWEEN LIPS OF GUTTERS. SANITARY SEWER PROPOSED AS 10-INCH PVC AT SLOPE = 0.25% – DATA PROVIDED ON UTILITY PLAN. SEE UTILITY AND DRAINAGE PLANS – PROPOSED 36-INCH FRONTAGE PIPING SHOWN. TYPICAL SECTION SHOWS PROPOSED TRAIL/SIDEWALK. GROUND SLOPE IS RATHER MINIMAL (< 2%); IMPROVEMENT PLANS FORTHCOMING.
 - (12) NO PROPOSED OPEN SPACE; DETENTION POND OWNERSHIP/MAINTENANCE ASPECTS TO BE DETERMINED.
 - (13) PRELIMINARY TITLE REPORT ON FILE WITH COUNTY.

HANSEN & ASSOCIATES, INC.
Consulting Engineers and Land Surveyors
538 North Main Street, Brigham City, Utah 84302
Visit us at www.haies.net
Logan
Brigham City
(801) 399-4905 (435) 722-8272



Drawn By: MTH Date: 01/26/17
Designed By:
Checked By:
Approved By:
Scale: 1" = 100'
Drawing File: 16-105 OPT 10a.DWG
JOB NUMBER: 16-105

OVERALL PLAN FOR
SUN CREST MEADOWS
2550 NORTH 4900 WEST
TAYLOR, UT 84401

Sheet
1
of
4
Sheets

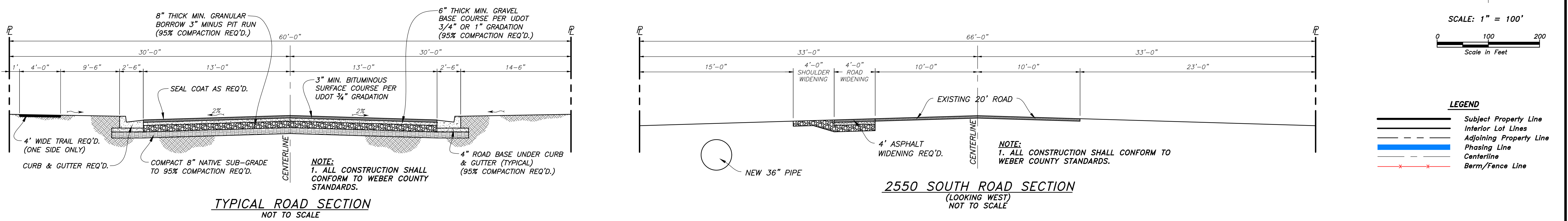

SCALE: 1" = 100'
0 100 200
Scale in Feet

LEGEND
— Subject Property Line
- - - Interior Lot Lines
- - - Adjoining Property Line
- - - Phasing Line
- - - Centerline
- - - Berm/Fence Line



Weber County Planning Division

Date: 12/03/2020
To: Western Weber Planning Commission
From: Scott Perkes – Planner | Weber County Planning Division

Subject: Short-term rental regulation scenarios and updated draft ordinance

Commissioners,

During the Western Weber Planning Commission's 11/10/2020 public hearing of the short-term rental regulation scenarios and draft ordinance, the Commission tabled the discussion and any recommendation to the County Commission until after the Ogden Valley Planning Commission had first made a formal recommendation.

During the Ogden Valley Planning Commission meeting held 11/17/2020, the Commission made a formal recommendation to the County Commission as follows:

*“Recommend **Option D, “Proof of Concept”**, to the County Commission for how to move forward with addressing the short-term rental issue in the Ogden Valley.”*

As a reminder, Option D, “Proof of Concept”, consists of the following:

The rental of a sleeping room, apartment, dwelling unit, or dwelling for a time period of less than 30 days is considered a short-term rental. Short-term rentals are allowed only when listed as either a permitted or conditional use in a specific zone or when approved as part of a planned residential unit development (PRUD).

- *This language is unchanged from existing regulation found in Sec. 108-7-25 “Nightly Rentals”*
- *3rd Party Enforcement is utilized to augment county enforcement efforts*
- *This scenario would be subject to the requirements and operational standards of the new short-term rentals ordinance.*

In order to move forward with this topic to the County Commission, the Planning Division will need the Western Weber Planning Commission to make a formal recommendation on this topic. As such, I look forward to wrapping-up our discussion on this topic during the upcoming 12/8/2020 Western Weber Planning Commission meeting. Please feel free to reach out should you have any questions.

Scott Perkes, AICP
Planner – Weber County Planning Division
isperkes@webercountyutah.gov
801-399-8772

Attachments:

Attachment A – Draft STR Ordinance Including 5 Potential Regulation Scenarios

Attachment A

Sec 108-23 Short-Term Rentals

The four regulation scenarios listed below represent a few options for potential short-term rental regulation. These scenarios have been created to facilitate discussion. Any future adopted regulation may or may not follow one or none of these scenarios.

Open Scenario:

Any residential property within the unincorporated Weber County may obtain a short-term rental license to rent a sleeping room, apartment, dwelling unit, or dwelling for a time period of less than 30 days.

- 3rd Party Enforcement **is utilized** to augment county enforcement efforts
- This scenario would be subject to the requirements and operational standards of this chapter.

Open/Limited Scenario:

With exception to properties in the FR-1 zone, any residential property within the unincorporated Weber County may obtain a short-term rental license to rent a sleeping room, apartment, dwelling unit, or dwelling for a time period of less than 30 days subject to the requirements and standards of this chapter.

- This scenario also employs a geographic separation requirement that would prevent STR properties from being located adjacent to, or within a specified distance of another STR property.
- 3rd Party Enforcement **is utilized** to augment county enforcement efforts
- This scenario would be subject to the requirements and operational standards of this chapter.

Business as Usual Scenario:

The rental of a sleeping room, apartment, dwelling unit, or dwelling for a time period of less than 30 days is considered a short-term rental. Short-term rentals are allowed only when listed as either a permitted or conditional use in a specific zone or when approved as part of a planned residential unit development (PRUD).

- This language is unchanged from existing regulation found in Sec. 108-7-25 "Nightly Rentals"
- 3rd Party Enforcement **is NOT utilized** to augment county enforcement efforts
- This scenario would **NOT be Subject** to the requirements and standards of this chapter.

Proof of Concept Scenario:

The rental of a sleeping room, apartment, dwelling unit, or dwelling for a time period of less than 30 days is considered a short-term rental. Short-term rentals are allowed only when listed as either a permitted or conditional use in a specific zone or when approved as part of a planned residential unit development (PRUD).

- This language is unchanged from existing regulation found in Sec. 108-7-25 "Nightly Rentals"
- 3rd Party Enforcement **is utilized** to augment county enforcement efforts
- This scenario would be subject to the requirements and operational standards of this chapter.

Closed Scenario:

The county will continue to allow STR licenses to be issued in the DRR-1 zone going forward. Except for existing owners with a valid conditional use permit and business license, STRs will no longer be allowed as a conditional use in the FR-3 zone. Owners within existing PRUD developments (with approved STR use) will be allowed to obtain an STR license, or continue renting if already licensed. New PRUD developments will no longer be approved with the STR use.

- 3rd Party Enforcement **is NOT utilized** to augment county enforcement efforts
- This scenario would **NOT be Subject** to the requirements and standards of this chapter.

Commented [PS1]: This language is unchanged from the existing Sec. 108-7-25 "Nightly Rentals"

Commented [PS2]: This language is unchanged from the existing Sec. 108-7-25 "Nightly Rentals"

Attachment A

44 **Sec 108-23-X Purpose And Intent**

45 There are benefits to allowing owners of residential units within the County to rent their dwelling units for short
46 periods of time. Short-term rental of dwelling units also brings capacity and diversification to the visitor-
47 accommodation market. However due to the potential for adverse impacts, short-term rentals must be
48 regulated by the County to protect the health, safety, and welfare of owners, neighbors, and visitors.

49 The intent of this Chapter is to establish procedures and standards by which residential short-term rentals can
50 be provided to visitors and tourists in a manner that protects both the quality of their experience, and the
51 communities in which they are located.

52 **Sec 108-23-X Applicability**

53 Four applicability scenarios for consideration: "Open", "Open/Limited", "Business as Usual", "Proof of Concept",
54 and "Closed".

55 **Sec 108-23-X Prohibitions**

56 A short-term rental license will not be issued for any of the following:

- 57 (a) *Accessory Buildings and Accessory Dwelling Units.* Short-term rentals are not allowed in any accessory
58 building, including licensed accessory dwelling units (ADUs), unless specifically provided for in other
59 areas of this land use code. A property that contains a licensed ADU is not eligible to obtain a short-term
60 rental license for the primary residence.
- 61 (b) *Deed Restricted Housing.* Short-term rentals are not allowed in properties that have been deed
62 restricted for affordable or workforce housing.

63 ~~(c) *Private Covenants.* A short-term rental license will not be issued for any property that is subject to any~~
64 ~~recorded private covenants that restrict the property's use for short-term rentals, regardless of whether~~
65 ~~or not such private covenants are enforced by a homeowners association or committee. Private~~
66 ~~covenants may be identified as covenants, conditions and restrictions (CC&Rs), protective covenants,~~
67 ~~restrictive covenants or neighborhood covenants. A short-term rental license will not be issued for any~~
68 ~~property that is subject to a private covenant that restricts the property's use for short-term rentals.~~

69 ~~(d)~~(c) **Sec 108-23-X Short-Term Rental License Required**

70 (a) *Licensing.* It is unlawful for an owner to rent any property for a time period of less than 30 days within
71 the unincorporated area of Weber County without a valid short-term rental license pursuant to this
72 Chapter. An issued short-term rental license shall also be considered a land use permit for the purpose
73 of operating a short-term rental unit.

74
75 (b) *Geographic Separation of Licenses.* With exception to the DRR-1 zone, PRUD developments with short-
76 term rental approvals, and properties in the FR-3 zone with valid short-term rental licenses at the time
77 of the adoption of this chapter (XX/XX/20XX), all licensed short-term rental units shall be located a
78 minimum of 500 feet from other licensed short-term rental units.

79
80 (c) *Initial Licensing Period.* Following the adoption of this chapter, County staff will process short-term
81 rental license applications by the order in which they are received. License applications that are found to

Commented [PS3]: This section is only applicable to the "Open/Limited" applicability scenario.

Commented [PS4]: This section is only applicable to the "Open/Limited" applicability scenario.

Attachment A

82 have a proposed short-term rental unit within an existing 500-foot separation buffer will be denied until
83 such a time in which a nearby license/s creating the encumbrance become expired or revoked.

(d) Licensing Procedure

85 (1) The owner or authorized representative shall submit a notarized short-term rental license
86 application on a form provided by the Planning Division, and shall pay the application fee set by
87 County Commission resolution.

88 (2) Applications shall be accompanied by the following materials:

- 89 a. Detailed floor plan and site plan of rental property indicating all areas allowed to be
90 occupied by short-term occupants
- 91 b. Parking plan demonstrating compliance with the parking standards established in Sec
92 XXX-XX-X
- 93 c. Trash disposal and collection plan demonstrating compliance with the trash disposal and
94 collection standards established in Sec XXX-XX-X
- 95 d. Proof of homeowners' and liability insurance
- 96 e. Preliminary title report dated within 30 calendar days prior to the submittal of an
97 application.

98 ~~f. For properties that are subject to any recorded private covenants, applicants must
99 submit a letter from the community's homeowners association or committee, or submit
100 a copy of the private covenants including any amendments to such private covenants, to
101 verify the short-term rental of dwellings is not restricted. For properties located within
102 an HOA, applicants must submit either a letter from the HOA board, a copy of the
103 community's Covenants, Conditions, & Restrictions (CC&Rs), or other acceptable
104 documentation verifying the community does not have a regulation prohibiting the
105 short term rental of dwellings.~~

106 ~~g.f.~~ Outdoor lighting plan showing compliance with Section 108-16.

107 ~~h.g.~~ Submission of the name and contact information associated with the individual or
108 management company being designated as the Responsible Agent.

109 ~~i.h.~~ Signed acknowledgement by the owner and responsible agent that they have read this
110 short-term rentals ordinance and understand the licensing, operational standards, and
111 violation structure.

112 (e) *Application Review Procedure.* Upon submission of a complete application for a short-term rental
113 license, staff shall circulate the application to the Planning Division, Building Department, Fire District,
114 Health Department, and any other reviewing agency deemed appropriate for adequate review and
115 approval of the license. Reviewing agencies shall have 30 days to review the submitted plans and return
116 any requests for additional information or conditions of approval to the applicant. Applicants shall have
117 60 days to comply with review agency requests or the application will be removed from consideration.

120 (f) *Issuance of License.* All licenses shall be issued to property owners. Licenses are tied to the owner for a
121 specific property and are non-transferable to other properties or other owners, except to individuals
122 who are next of kin. Licenses shall be issued for a period of one year and shall expire at the end of each
123 calendar year.
124

Commented [P55]: This highlighted language is only applicable to the "Open/Limited" applicability scenario.

Attachment A

125 (g) *License Renewal*. Existing licenses must submit for renewal and pay the required fee by no later than
126 **December 1st** of each year to remain valid through the next calendar year. Licenses issued anytime mid-
127 year will be required to renew their license by **December 1st** of the same year in order to become
128 concurrent with the sequential annual licensing cycle. Owners wishing to renew a license must provide:

- 129 (1) License renewal application
- 130 (2) Inspection report (if required by **Sec. XXX-XX-X**)

131 **Sec 108-23-X Property Inspection**

133 (a) *Initial property inspection*. Properties applying for their first short-term rental license shall be inspected
134 for compliance with the provisions of this chapter and other applicable sections of this Land Use Code.
135 The Planning Division shall have the option of designating a county inspector or a 3rd party building
136 inspector. Any deficiencies found during this initial inspection shall be resolved to the satisfaction of the
137 inspector prior to the release of a short-term rental license. Should the deficiencies not be resolved
138 within **90 days** from the time of initial inspection, the application shall be removed from consideration
139 and a short-term rental license will not be issued.

140
141 (b) *License renewal property inspection*. The County, at its discretion, may require that a property be
142 inspected prior to the renewal of an existing license. The Planning Division shall have the option of
143 designating a county inspector or a 3rd party building inspector. Should the property fail the inspection,
144 the owner shall have **90 days** to bring their property into compliance or the license will be suspended. A
145 license may be immediately suspended should life/safety concerns arise during the inspection. If a
146 license is suspended due to life/safety concerns, the property owner must rectify the concerns prior to
147 the license suspension being lifted.

148 **Sec 108-23-X Applicable Taxes And Remittance**

149 Owners of short-term rentals are responsible to collect and remit all applicable state and local taxes. Owners
150 who fail to collect and remit applicable taxes during the license period shall have their short-term rental license
151 suspended and shall not be eligible to renew their license for the next year. To have their license reinstated and
152 renewed, owners may submit payment for all unpaid back taxes in addition to payment of an administrative
153 penalty as established in **Sec XXX-XX-X** for a major violation.

154 **Sec 108-23-X Responsible Agent**

155 The owner of a short-term rental shall appoint a Responsible Agent for the rental property. This appointed agent
156 may be the owner, independent property manager, or a professional property management company. The
157 appointed responsible agent shall be on-call to manage the property during any period within which the
158 property is occupied. This agent must be able to respond, in person if needed, within **60 minutes** to address any
159 complaints, to the best of their ability, which may arise from the operation of the short-term rental. A
160 responsible agent is not required to, and should not, place themselves in a situation that could cause them
161 physical harm in order to attempt to address a complaint. The owner shall notify the Planning Division within
162 three days of a modification to the appointed responsible agent and shall provide name, address, and telephone
163 number of any newly appointed agent. It is the owner's responsibility to update this information throughout the
164 term of the license.

165 **Sec 108-23-X Operational Standards**

Attachment A

166 (a) *Information Dissemination Requirements.* The owner shall post the following information in a prominent
167 and visible location:

- 168 (1) *Internal posting.* Each licensed short-term rental property shall have the following information
169 posted in a conspicuous location where it can be easily viewed by tenants:
- 170 a. Short-Term Rental License number;
 - 171 b. Contact information for the owner and responsible agent, including a phone number for
172 24-hour response to emergencies;
 - 173 c. The property's maximum occupancy;
 - 174 d. The property-specific parking plan including the maximum number of vehicles allowed
175 to be parked on the property and applicable parking rules;
 - 176 e. Description of the location/s of fire extinguishers and emergency egress routes;
 - 177 f. Good neighbor requirements regarding noise, parking, trash pickup, and fire
178 restrictions;
 - 179 g. Current fire restriction information as disseminated through the Weber County Fire
180 District website; and
 - 181 h. Any other information deemed necessary by the reviewing agencies to ensure the
182 public's health and safety.
- 183 (2) *Street Addressing.* Each licensed short-term rental property shall have its assigned street
184 address posted externally in a conspicuous location where it can be easily viewed day or night
185 from the adjacent access way.

186 (b) *Advertising Requirements.* As provided in UCA 17-50-338, the following advertising requirements are not
187 intended to prohibit an individual from listing a property for short-term rental on any short-term rental
188 website. All advertising for a short-term rental property shall include:

- 189 (1) The property's short-term rental license number
- 190 (2) The property's maximum permitted occupancy
- 191 (3) Maximum parking capacity
- 192 (4) A digital link to the County's short-term rental regulations
- 193 (5) The following language shall be included verbatim in a prominent location of the advertisement:
- 194 "Any advertisement for a short-term rental property in unincorporated Weber County, Utah,
195 that does not provide a unique license number is unlikely to be a lawfully licensed short-term
196 rental."
197

198 (c) *Occupancy*

- 199 (1) *Occupancy Limits.* The maximum occupancy for a short-term rental property shall be no more
200 than **two** people per bedroom, plus **four** people up to a maximum of **10** people.
- 201 a. A property's maximum occupancy may be reduced due to a property's unique
202 characteristics, including but not limited to, limited parking, septic/sewer system
203 capacity, culinary water rights, etc.
 - 204 b. A greater maximum occupancy may be approved following additional review and
205 approval of applicable reviewing agencies and the provision of additional components
206 that would otherwise limit capacity including, but not limited to, fire suppression
207 systems, parking, septic/sewer capacity, culinary water rights, sleeping rooms, etc.
208

Attachment A

209 (2) *Single Contract.* With exception to condominiums with approved lock-off units in the DRR-1
210 zone or PRUD developments with approved short-term rental use, owners shall not concurrently
211 rent individual rooms or areas to unrelated parties for the same night or nights.

Formatted: Underline, Font color: Light Blue

Formatted: Font color: Light Blue

212 (3) *External sleeping accommodations prohibited.* All sleeping accommodations must be maintained
213 internal to the licensed dwelling unit as indicated by the floorplan that was submitted and
214 approved during the licensing process. External accommodations such as yurts, teepees, tents,
215 or other temporary structures may not be used for sleeping accommodations or as a means to
216 increase the maximum permitted occupancy.

217 (4) *Duration.* , No licensed short-term rental unit may be rented for less than **three** consecutive
218 days, with exception to the following areas:

- 219 a. Licensed properties within the DRR-1 zone
- 220 b. Properties located within PRUD developments with short-term rental approval.
- 221 c. Properties located within the FR-3 zone that have obtained a valid conditional use
222 permit and short-term rental license prior to **XX-XX-XXXX**.

223 (d) *Parking.* In addition to the parking requirements for dwellings, as outlined by Sec. 108-8-2 of this Land
224 Use Code, the following parking regulations are also required for all licensed short-term rental
225 properties.

- 226 (1) All vehicles of occupants and visitors of a short-term rental property shall be parked only within
227 the property's boundary lines. Additionally, no more than **25%** of the property's front or side
228 yard setbacks shall be dedicated to parking.
- 229 (2) No parking is allowed within the property's adjacent rights-of-way.
- 230 (3) No more than one parking space per sleeping room may be provided.
- 231 (4) No vehicles shall be parked on the lawn or landscaped areas of the property.
- 232 (5) No person shall be permitted to stay overnight in any vehicle which is parked at the property.
- 233 (6) No vehicles with a passenger capacity of greater than sixteen **(16) persons** may be parked at the
234 property.

235 (e) *Noise.* At no time shall the noise emanating from the property exceed **65 dB** as measured from the
237 property line. Between the hours of **10:00 pm and 8:00 am**, no sound exceeding **55 dB**, and no amplified
238 or reproduced sound, shall be allowed as measured from the property line.

239 (f) *Trash disposal and collection.* All short-term rental properties shall provide a trash disposal and
241 collection plan at the time of license application to ensure that trash containers are not left outdoors
242 where they can cause issues for wildlife, snow removal operations, or cause unsightliness. With
243 exception to the property's assigned trash pick-up day, trash containers must be stored behind the
244 property's front setback line and must be shielded from the view of adjacent public rights-of-way. The
245 designated responsible agent shall ensure that any trash generated that exceeds the typical pick-up
246 schedule is collected and removed from the property as needed on a case by case basis. Properties with
247 larger maximum permitted occupancies may require the procurement of additional trash cans to
248 accommodate the volume of anticipated trash being generated.

249 (g) *Outdoor lighting.* Incorporated herein for all properties located in unincorporated Weber County
251 desiring a short-term rental license, all outdoor lighting associated with a short-term rental shall at all
252 times comply with the exterior lighting requirements set forth in Sec 108-16 of the Land Use Code.

Attachment A

253
254 (h) *Signage.* On-site signage intended to advertise the property as a short-term rental is not permitted
255 anywhere on the property or adjacent right-of-way.
256

257 (i) *Fire safety.*

- 258 (1) The property must have primary access along a public right-of-way or access easement that
259 meets the fire marshal's requirements for a fire access road.
- 260 (2) The property must have a fire prevention system as approved by the fire marshal.
- 261 (3) Outdoor fire pits must be permanently affixed natural gas or propane gas fixtures.
- 262 (4) Smoke and carbon monoxide detectors must be installed and maintained per current building
263 and fire codes.
- 264 (5) Fire extinguishers must be placed in an approved location on each level of the property and
265 adjacent to outdoor fire pits.
- 266 (6) An emergency egress plan must be posted in a conspicuous location on each level of the
267 property.
- 268 (7) Properties located within the Wildland-Urban Interface (WUI) area shall comply with the current
269 Wildland-Urban Interface code requirements.

270 **Sec 108-23-X Complaints And Violations**

271 (a) *Complaints.* The Planning Division requires all complaints regarding the operation of any short-term
272 rental unit to be made through the County's short-term rental hotline or website.

- 273 (1) Complaints concerning the use or occupancy of a licensed short-term rental unit may be made
274 to the County through the County's short-term rental hotline or website. The subject of the
275 complaint may include, without limitation, such things as parking, trash, noise, or other
276 concerns related to the short-term rental unit. The complaining party will then be provided with
277 a reference number associated with their complaint; however, anonymous complaints made
278 through the website or call center will not be processed.
- 279 (2) When a complaint concerning a short-term rental unit has been received, contact to the
280 responsible agent for the unit will be attempted by a County designee using the telephone
281 number on file with the County. If the responsible agent can be reached by phone, the agent will
282 be notified of the details of the complaint as filed by the complaining party. The time that the
283 responsible agent was notified shall be recorded.
- 284 (3) The responsible agent is required to make an attempt to resolve the issue that was subject to
285 the complaint as outlined in **Sec 108-23-XX**. The responsible agent shall promptly notify the
286 County's hotline if the agent believes a complaint has been successfully resolved. If the County's
287 hotline does not receive notification from the responsible agent that a complaint has been
288 successfully resolved within the timeframes outlined in **Sec 108-23-XX**, it shall be presumed that
289 the complaint has not been successfully resolved, and the complaining party may follow up with
290 the County's hotline or website with the reference number issued for the original complaint.
- 291 (4) If a complaint involves the immediate health and safety of any person or property, or if, despite
292 good faith efforts, the problem that was the subject of a complaint cannot be resolved, the
293 responsible agent shall immediately contact the police, and follow any direction(s) given by the
294 police.

Attachment A

- 295 a. If a complaint is not resolved to the satisfaction of the complaining party, a formal
296 complaint may be filed with the Planning Division. The formal complaint shall describe in
297 detail the violation(s) of this chapter alleged to have occurred on the short-term rental
298 property. Within three (3) days of receipt of such a complaint, the County shall provide a
299 copy of the formal complaint to the owner and responsible agent if applicable. Formal
300 complaints shall be signed by an individual and are subject to public inspection; no
301 anonymous formal complaints shall be accepted.
- 302 b. The County shall investigate any formal complaint received, in order to determine if it is
303 a substantiated complaint that represents a documented violation of any provision(s) of
304 this Chapter.

305 (b) *Violations.* For the purposes of this chapter violations for licensed short-term rental properties shall be
306 classified as either a Minor Violation or a Major Violation. Violations for unlicensed rental properties
307 shall be classified as an Unlicensed Violation.

308 (1) *Minor violations.* A minor violation shall be any violation of the short-term rental standards as
309 provided in **Sec XXX-XX-X** and **XXX-XX-X**.

310 a. Owners will be given one warning following their first minor violation within each
311 calendar year. If this warning is subject to a static and prevailing concern, owners shall
312 be given three calendar days to correct the issue or the warning will become a
313 documented minor violation.

314 b. After three minor violations within 12 consecutive months, the owner shall be issued a
315 major violation on the fourth and subsequent occurrences.

316 c. Each minor violation shall be subject to an administrative penalty as provided in **Sec**
317 **108-23-XX**.

318 (2) *Major violation.* A major violation shall consist of the failure of the responsible agent to perform
319 their responsibilities as provided in **Sec. XXX-XX-X**, or the fourth and subsequent minor violations
320 within a 12 month consecutive time frame as provided in **Sec. XXX-XX-X**.

321 a. Owners will be given one warning in the event of a responsible agent failing to perform
322 their responsibilities within each calendar year.

323 b. Each major violation shall be subject to administrative penalties as provided in **Sec XXX-**
324 **XX-X**.

325 (3) *Unlicensed violation.* An unlicensed violation is committed upon the rental of an unlicensed
326 property on a short-term basis.

327 a. Owners will be given one warning within each calendar year. Each violation thereafter
328 shall be subject to administrative penalties as provided in **Sec XXX-XX-X**.

Sec 108-23-X Administrative Penalty

330 Any person found in violation of any provision(s) of this Chapter is liable for an administrative penalty in the
331 form of a monetary fine based on the property's average nightly rate. The average rental rate of the property
332 shall be determined through advertised nightly rental rate. Each day a violation remains unresolved shall carry a
333 daily administrative penalty and monetary fine as follows:

334 (a) *Minor violations.* Monetary fines shall be **50%** of the advertised nightly rental rate on the date/s of the
335 violation.

336 (b) *Major violations.* Monetary fines shall be **100%** of the advertised nightly rental rate on the date/s of the
337 violation.

Attachment A

338 (c) *Unlicensed violations.* Monetary fines shall be 200% of the advertised nightly rental rate on the date/s of
339 the violation. If the unlicensed property does not have advertised rental rates, then the administrative
340 penalty shall be the average nightly rental rate for all rental properties located in unincorporated Weber
341 County for the dates associated with the violation.

Sec 108-23-X License Revocation

342 (a) *Revocation due to minor violations.* If a short-term rental unit has four minor violations within three
343 consecutive months, or six minor violations within twelve consecutive months, the short-term rental
344 license shall be revoked in accordance with the provisions of Sec. 102-4-3.

345 (1) If a short-term rental license is revoked due to an accumulation of minor violations, for a
346 minimum of one year following the revocation, the County shall not accept an application for a
347 new license for the same short-term vacation rental property; with the exception that a new
348 application by a new property owner, proven to be unaffiliated with the property owner whose
349 license was revoked, may be considered.

350 (b) *Revocation due to major violations.* If a short-term rental unit has two major violations within three
351 consecutive months, or four major violations within twelve consecutive months, the short-term rental
352 license shall be revoked in accordance with the provisions of Sec. 102-4-3.

353 (1) If a short-term rental license is revoked due to major violations, for a minimum of two years
354 following the revocation, the County shall not accept an application for a new license for the
355 same short-term vacation rental property; with the exception that a new application by a new
356 property owner, proven to be unaffiliated with the property owner whose license was revoked,
357 may be considered.

Sec 108-23-X License Revocation Appeal Procedure

360 Any owner who has been issued a notice of impending license revocation may file an appeal with the Planning
361 Division as directed by Sec 102-4-3.

362 Amendment to Sec 102-4-3: (Required to accommodate this new ordinance and permit type.)

363 A land use permit or conditional use permit may be revoked for violation of any part of this Land Use Code
364 related to the specific use or permit in accordance with the following:

365 (a) Revocation shall be conducted by the land use authority that is authorized to approve the permit.

366 ~~(b) Prior to permit revocation, the land owner and, if different, permittee shall be given reasonable~~
367 ~~opportunity to resolve the violation by bringing the property into compliance or by diligently pursuing~~
368 ~~an amendment or modification to the permit, as may be allowed by this Land Use Code.~~

369 ~~(c)(b) In the event compliance cannot be attained,~~ (b) the land-owner and, if different, permittee shall be
370 given a notice of the impending permit revocation 14 days prior to final revocation. The notice of the
371 impending permit revocation shall specify the violation, and inform the land-owner and, if different,
372 permittee of the right to request a hearing.

373 ~~(c)~~ (c) The land owner and, if different, permittee shall have a right to a hearing with the land use
374 authority to show cause for why the permit should not be revoked, if a written request for such is
375 submitted prior to a final written revocation decision. If a hearing is requested, final revocation of the
376 permit shall be stayed until after the hearing. The hearing shall be scheduled at a time specified by the
377 land use authority.

Commented [P56]: These amendments will need to consider "License" vs. "Permit" nomenclature in order to be consistent.

Attachment A

380 ~~(e)~~(d) Revocation of a permit is final upon the issuance of a final written
381 decision may be appealed pursuant to title 102, chapter 3.
382 ~~(f)~~(e) Revocation of a permit shall not prohibit prosecution or any other legal action taken on account
383 of the violation, as provided in this Land Use Code or any other applicable law
384