

STRUCTURAL CALCULATIONS

REVISED December 23, 2019

Project:

Powder Mountain Lot 80

8483 E. Spring Park

Summit Powder Mountain Resort

Weber County, UT

Project Number: 9085A

Prepared For:

Scandinavian

6410 N. Business Park Loop Rd. Unit E

Park City, Utah 84098

Date:

November 2019

Prepared By:

Alex Hawkins, PE

Project Manager:

David A. Jenkins, PE, SE

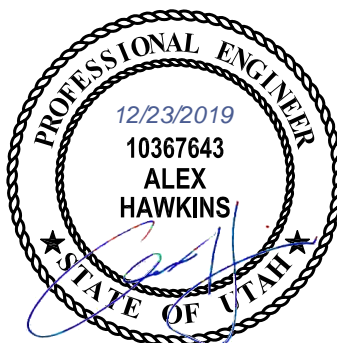

ENSIGN
THE STANDARD IN ENGINEERING

Ensign Engineering

45 West 10000 South, Suite 500

Sandy, Utah 84070

P: (801) 255-0529

F: (801) 255-4449

ensigneng.com

PLAN REVIEW ACCEPTANCE

FOR COMPLIANCE WITH THE APPLICABLE CONSTRUCTION CODES IDENTIFIED BELOW.

- | | |
|--|--|
| <input checked="" type="checkbox"/> BUILDING | <input checked="" type="checkbox"/> STRUCTURAL |
| <input checked="" type="checkbox"/> MECHANICAL | <input checked="" type="checkbox"/> PLUMBING |
| <input checked="" type="checkbox"/> ELECTRICAL | <input checked="" type="checkbox"/> ENERGY |
| <input type="checkbox"/> ACCESSIBILITY | <input type="checkbox"/> FIRE |

PLAN REVIEW ACCEPTANCE OF DOCUMENTS DOES NOT AUTHORIZE CONSTRUCTION TO PROCEED IN VIOLATION OF ANY FEDERAL, STATE, OR LOCAL REGULATIONS.

BY: **MEM** DATE: 01/09/20

WEST COAST CODE CONSULTANTS, INC.



Project: Powder Mountain Lot 80

By: Alex Hawkins, PE

Date: November 2019

Project No.: 9085A

Checked By: DAJ

GENERAL PROJECT INFORMATIONClient: **Scandinavian**Project: **Powder Mountain Lot 80**Project Address: **8483 E. Spring Park
Summit Powder Mountain Resort**

Latitude: 41.363 North (Approximate)
 Longitude: -111.747 West (Approximate)
 Elevation above Sea Level: 8,557 ft

PROJECT DESCRIPTION

Provide structural calculations for Scandinavian Log Home

GENERAL DESIGN CRITERIA

Structure Type:	Structure Type	Building Height, h_n (ft)	28
Design Code:	2018 IBC	Number of Stories	2
Risk Category:	II	Light-frame Construction?	No

DESIGN LOADS & SERVICEABILITY REQUIREMENTS**Dead Loads:**

-Roof DL:	
Total Roof DL:	15 psf
-Floor DL:	
Total Floor DL:	20 psf
-Wall DL:	
Exterior Walls:	20 psf
Interior Bearing Walls:	15 psf
Log Walls:	30 psf

Snow Loads:

Surface Roughness Category:	C
Roof Exposure:	Partially Exposed
Thermal Condition:	All other structures
Roof Surface:	Non-Slippery (Rough)
Obstructed?	No
Roof Pitch	1 /12
Roof Angle, θ	4.8
Ground Snow Load, p_g :	384 psf
Exposure Factor, C_e :	1.00
Thermal Factor, C_t :	1.00
Importance Factor, I_s :	1.00
Slope Factor, C_s :	1.00
Minimum Roof Snow Load, p_m :	20 psf
Flat Roof Snow Load, p_f:	269 psf (Balanced)
Sloped Roof Snow Load, p_s:	269 psf (Balanced)
Seismic Snow Load, $p_{f,seismic}$:	54 psf

Wind Loads:

Basic Wind Speed, V :	104 mph (3-second gust)
ASD Wind Speed, V_{asd} :	81 mph (3-second gust)
Exposure:	C

Seismic Loads:

S_S :	0.802 g
S_1 :	0.277 g
Site Soil Class:	C
	--
Importance Factor, I_E :	1.00

Live Loads:

Roof Live:	20 psf
Floor Live:	40 psf
Main Floor Corridor / Stair:	40 psf
Balconies:	60 psf

Rain Loads:

Rain Intensity, I (in/hr):	1.5
------------------------------	-----

Deflection Limits:

		Total Load	Live Load
Roof:	L /	240	360
Floor:	L /	360	480
Horizontal:	L /	--	240



Project: Powder Mountain Lot 80

By: Alex Hawkins, PE

Date: November 2019

Project No.: 9085A

Checked By: DAJ

FOUNDATION CRITERIA & SPECIFICATIONS

Geotechnical Report: Company: AGEC
 Date: July 12, 2019
 Report / Project Number: 03092-001
 Contact: David A. Glass, P.E.

Allowable Bearing Pressure: 2,800 psf
 Allowable Bearing Increase for Wind & Seismic Loads: 1.33

	Static Loading	Increase for Dynamic Loading	
Passive Pressure:	<u>375</u>	<u>-40.8</u>	pcf
Active Pressure:	<u>41.7</u>	<u>15.1</u>	pcf
At Rest Pressure:	<u>55</u>	<u>22.5</u>	pcf

Coefficient of Friction, μ : 0.48

Foundation Type: Footing Type: Concrete Spread Footing
 Min. Depth to Frost: 42 in

MATERIAL SPECIFICATIONS

CONCRETE & REINFORCING STEEL SPECIFICATIONS:

Concrete Strength, f'_c :

Footings:	<u>3,000</u>	psi (As allowed by Utah State Code Amendment)
Concrete Walls:	<u>4,500</u>	psi (Buried foundation walls can be 3000 psi as allowed by Utah State Code Amendment)
Grade Beams:	<u>4,000</u>	psi
Slab on Grade:	<u>4,000</u>	psi
Bearing/Shear Walls:	<u>4,000</u>	psi

Deformed Reinforcing Bars: ASTM A615 Grade 60
 ASTM A706 Grade 60 Weldable Rebar is to be used where welds are specified on contract documents

Welded Wire Fabric: ASTM A185 - Flat sheets, not rolls

STEEL FRAMING SPECIFICATIONS

Structural Steel: W-Shape: ASTM A992, $F_y = 50$ ksi
 Tubing: ASTM A500, Grade B, $F_y = 46$ ksi
 Channels, Plates and Angles: ASTM A36, $F_y = 36$ ksi
 Pipe: ASTM A53, Grade B, $F_y = 35$ ksi
 Machine Bolts: ASTM A307
 High-strength Bolts: ASTM A325 or A490

Welds: E70XX Electrodes, Comply with AWS D1.1



Project: Powder Mountain Lot 80

Project No.: 9085A

By: Alex Hawkins, PE

Checked By: DAJ

Date: November 2019

WOOD FRAMING SPECIFICATIONS

Unless noted otherwise, the following species and grades of lumber shall be used.

Sawn Lumber:	Species: Douglas Fir-Larch (North)
	2x4 studs up to 8'-0" long: Stud Grade
	2x4 studs over 8'-0" long: Grade #2
	Other studs: Grade #2
	Posts: Grade #1
	Joists: Grade #2
	Beams: Grade #2
	Headers: Grade #2
	Subpurlins: Grade #2
	Purlins: Grade #2
Glue Laminated Beams:	Species: Douglas Fir-Larch (North)
	Simple Spans: 24F-V4
	Continuous Spans: 24F-V8
Sheathing:	APA Rated OSB
Framing Hardware:	Simpson Strong-Tie Connectors
Structural Nails:	Common Wire Type (unless noted otherwise)
Bolts in Wood:	ASTM A307



Project: Powder Mountain Lot 80
 By: Alex Hawkins, PE
 Date: November 2019

Project No.: 9085A
 Checked By: DAJ

SNOW DRIFT ANALYSIS - DRIFTS DUE TO ADJACENT STRUCTURES RAMP

CHAPTER 7, ASCE 7-16

IBC 2018 / ASCE 7-16

Design Parameters

Surface Roughness Category	C
Roof Exposure	Partially Exposed
Thermal Conditions	All other structures
Roof Surface	Non-Slippery (Rough)
Obstructed?	No
Roof Pitch	1 /12
Roof Angle, θ	4.8
Snow Drift Analysis Required?	Yes

Ground Snow Load, p_g (psf)	384	Utah Snow Load Study	Snow Density, γ (pcf)	30.0	Equation 7.7-1
Exposure Factor, C_e	1.00	Table 7.3-1	Balanced Snow Load Height, h_b (ft)	8.96	p_f / γ
Thermal Factor, C_t	1.00	Table 7.3-2	Horizontal Separation, s (ft)	0.0	
Importance Factor, I_s	1.00	Table 1.5-2	Vertical Separation, h (ft)	9.0	
Slope Factor, C_s	1.00	Figure 7.4-1	Length of Upper Roof, L_u (ft)	27.5	
Flat Roof Snow Load, p_f (psf)	269	Equation 7.3-1	Length of Lower Roof, L_L (ft)	27.0	
Sloped Snow Load, p_s (psf)	269	Equation 7.4-1			

Snow Drift Analysis

Full Windward Drift Height, $h_{d,full\ windward}$ (ft)	3.19	Section 7.7.1
Truncated Windward Drift Height, $h_{d,windward}$ (ft)	3.19	Figure C7.7-3
Full Leeward Drift Height, $h_{d,full\ leeward}$ (ft)	4.28	Section 7.7.1
Leeward Drift Height, $h_{d,leeward}$ (ft)	4.28	Figure C7.7-3
h_c (ft)	0.04	$h_r - h_b$
Design Drift Height, h_d (ft)	0.04	Section 7.7.1
Design Drift Width, w (ft)	25.70	Section 7.7.1
Maximum Drift Surcharge Load, p_d (psf)	1.20	Section 7.7.1

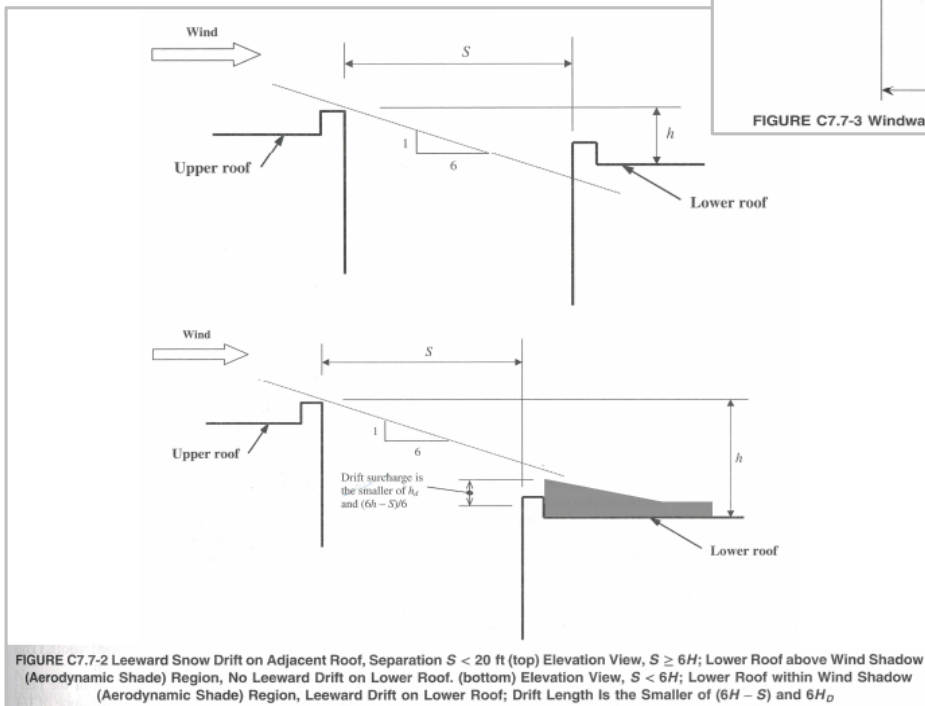
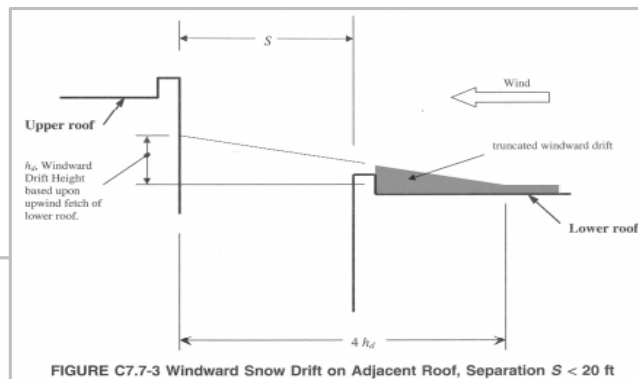



Project: Powder Mountain Lot 80
 By: Alex Hawkins, PE
 Date: November 2019

Project No.: 9085A
 Checked By: DAJ

SNOW DRIFT ANALYSIS - DRIFTS DUE TO ADJACENT STRUCTURES RAMP

CHAPTER 7, ASCE 7-16

IBC 2018 / ASCE 7-16

Design Parameters

Surface Roughness Category	C
Roof Exposure	Partially Exposed
Thermal Conditions	All other structures
Roof Surface	Non-Slippery (Rough)
Obstructed?	No
Roof Pitch	1 / 12
Roof Angle, θ	4.8
Snow Drift Analysis Required?	Yes

Ground Snow Load, p_g (psf)	384	Utah Snow Load Study	Snow Density, γ (pcf)	30.0	Equation 7.7-1
Exposure Factor, C_e	1.00	Table 7.3-1	Balanced Snow Load Height, h_b (ft)	8.96	p_f / γ
Thermal Factor, C_t	1.00	Table 7.3-2	Horizontal Separation, s (ft)	0.0	
Importance Factor, I_s	1.00	Table 1.5-2	Vertical Separation, h (ft)	13.0	
Slope Factor, C_s	1.00	Figure 7.4-1	Length of Upper Roof, L_u (ft)	45.0	
Flat Roof Snow Load, p_f (psf)	269	Equation 7.3-1	Length of Lower Roof, L_L (ft)	6.5	
Sloped Snow Load, p_s (psf)	269	Equation 7.4-1			

Snow Drift Analysis

Full Windward Drift Height, $h_{d,full\ windward}$ (ft)	2.78	Section 7.7.1
Truncated Windward Drift Height, $h_{d,windward}$ (ft)	2.78	Figure C7.7-3
Full Leeward Drift Height, $h_{d,full\ leeward}$ (ft)	3.90	Section 7.7.1
Leeward Drift Height, $h_{d,leeward}$ (ft)	3.90	Figure C7.7-3
h_c (ft)	4.04	$h_r - h_b$
Design Drift Height, h_d (ft)	3.90	Section 7.7.1
Design Drift Width, w (ft)	23.40	Section 7.7.1
Maximum Drift Surcharge Load, p_d (psf)	117.00	Section 7.7.1

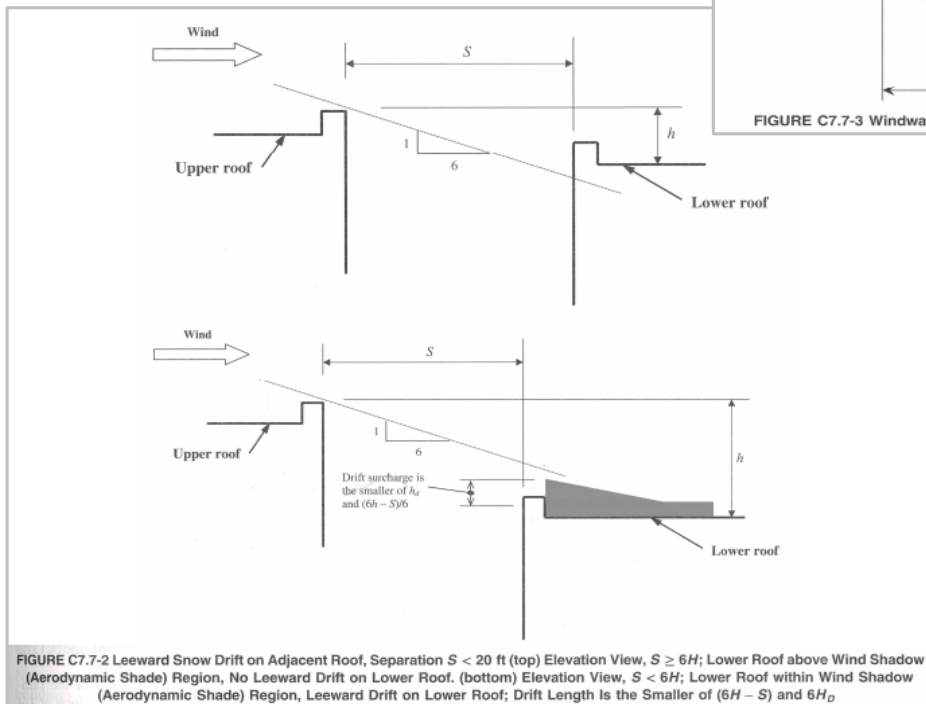
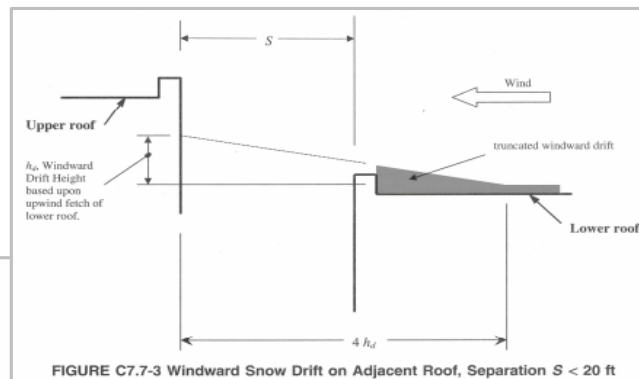



Project: Powder Mountain Lot 80

Project No.: 9085A

By: Alex Hawkins, PE

Checked By: DAJ

Date: November 2019

SEISMIC FORCE ANALYSIS - EQUIVALENT LATERAL FORCE PROCEDURE

CHAPTER 12, ASCE 7-16

IBC 2018 / ASCE 7-16

Design Parameters

Risk Category	II	Table 1604.5	Structure Type	All other structural systems	
Importance Factor, I _E	1.00	Table 1.5-2	T ₀ (sec)	0.086	Section 11.4.6
	--		T _S (sec)	0.432	Section 11.4.6
S _S (g)	0.802	Mapped	T _L (sec)	8	Section 11.4.6
S _I (g)	0.277	Mapped	S _a (g)	N/A	if T < T ₀ (Equation 11.4-5)
Site Class	C	Geotech Report	S _a (g)	0.642	T ₀ < T < T _S (Section 11.4-6)
F _a	1.20	Table 1613.2.3(1)	S _a (g)	N/A	T _S < T < T _L (Equation 11.4-7)
F _v	1.50	Table 1613.2.3(2)	C _t	0.02	Table 12.8-2
S _{MS} (g)	0.962	F _a S _S	x	0.75	Table 12.8-2
S _{M1} (g)	0.416	F _v S _I	T _a (sec)	0.243	Equation 12.8-7
S _{DS} (g)	0.642	2/3(S _{MS})	Response Modification Factor, R	2.5	Table 12.2-1
S _{D1} (g)	0.277	2/3(S _{M1})	Overstrength Factor, Ω ₀	2.5	Table 12.2-1
Seismic Design Category	D	Table 1613.2.5(1,2)	C _{S, Calculated}	0.257	Equation 12.8-2
Building Height, h _n (ft)	28		C _{S MAX}	0.683	Equation 12.8-3 & 12.8-4
Number of Stories	2		C _{S MIN}	0.028	Equation 12.8-5 & 12.8-6
Light-frame Construction?	No		C _S	0.257	Section 12.8.1.1

Vertical Distribution of Seismic Forces

Component	Unit Weight (psf)	Area (ft ²)	Weight, w _i (kips)	Elevation, h _i (ft)	w _i h _i ^k (kip-ft)	F _i (kips)	0.7F _i (kips)	
Roof Level:								
Roof + Seismic Snow	69	2,878	197.89	24	4,749.39	58.79	41.16	
Loft Roof + Seismic Snow	69	674	46.34	26	1,204.95	14.92	10.44	
Walls	30	2,257	67.70	24	1,624.68	20.11	14.08	
			-		-	-	-	
			-		-	-	-	
Main Level:								
Level 3 Floor	20	2,992	59.84	10	598.40	7.41	5.19	
Walls	30	1,460	43.80	10	438.00	5.42	3.80	
			-		-	-	-	
			-		-	-	-	
			-		-	-	-	
			-		-	-	-	
			-		-	-	-	
			-		-	-	-	
			Σw _i	416	Σw _i h _i ^k	8,615	V _x (kips)	106.65
					k	1	0.7V _x (kips)	74.66

Notes:

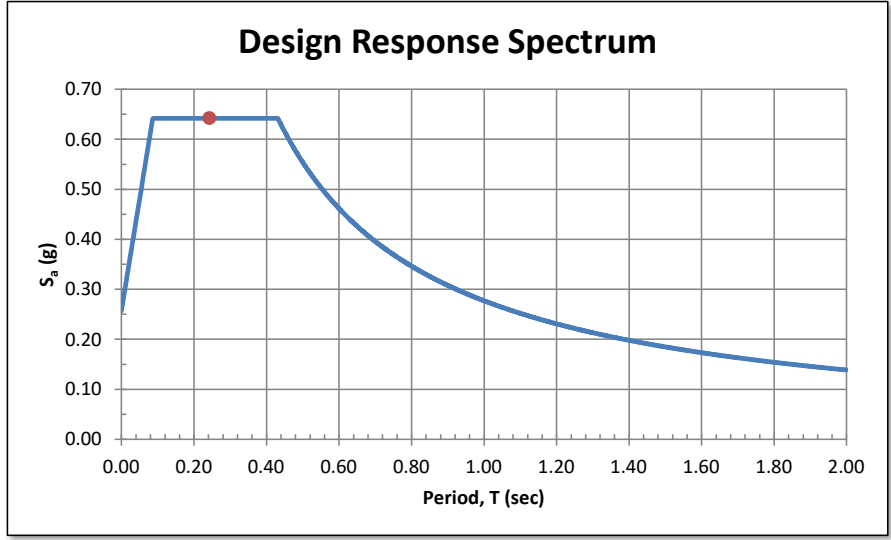



Project: Powder Mountain Lot 80
 By: Alex Hawkins, PE
 Date: November 2019

Project No.: 9085A
 Checked By: DAJ

SEISMIC FORCE ANALYSIS - DIAPHRAGM FORCES

CHAPTER 12, ASCE 7-16

IBC 2018 / ASCE 7-16

Design Parameters

Risk Category	II	Table 1604.5	S_{DS} (g)	0.642	$2/3(S_{MS})$
S_s (g)	0.802	Mapped	S_{D1} (g)	0.277	$2/3(S_{M1})$
S_1 (g)	0.277	Mapped	Seismic Design Category	D	Table 1613.2.5(1,2)
Site Class	C	Geotech Report	Importance Factor, I_E	1.00	Table 1.5-2

Diaphragm Design Forces

Level	Strength Level F_i (k)	Sum F_i (k)	w_{px} (k)	Sum w_i (k)	F_{px} (k) <i>Eq. 12.10-1</i>	$F_{px,min}$ (k) <i>Eq. 12.10-2</i>	$F_{px,max}$ (k) <i>Eq. 12.10-3</i>	LRFD: $F_{px,design}$ (k)	Scale Factor F_{px} / F_x
Roof	97.71	97.7	311.93	311.9	97.7	40.0	80.1	80.1	1.00
Main	12.83	110.5	103.64	415.6	27.6	13.3	26.6	26.6	2.07
		-		-	-	-	-	-	-
		-		-	-	-	-	-	-
		-		-	-	-	-	-	-
		-		-	-	-	-	-	-
		-		-	-	-	-	-	-
		-		-	-	-	-	-	-
		-		-	-	-	-	-	-



Project: Powder Mountain Lot 80

Project No.: 9085A

By: Alex Hawkins, PE

Checked By: DAJ

Date: November 2019

SEISMIC FORCE ANALYSIS - STRUCTURAL WALLS AND THEIR ANCHORAGE

CHAPTER 12, ASCE 7-16

IBC 2018 / ASCE 7-16

Design Parameters

Risk Category	II	Table 1604.5	<i>Calculation Comments:</i>
Importance Factor, I _E	1.00	Table 1.5-2	
	--		
S _S (g)	0.802	Mapped	
S ₁ (g)	0.277	Mapped	
Site Class	C	Geotech Report	
F _a	1.20	Table 1613.2.3(1)	
F _v	1.50	Table 1613.2.3(2)	
S _{MS} (g)	0.962	F _a S _S	
S _{M1} (g)	0.416	F _v S ₁	
S _{DS} (g)	0.642	2/3(S _{MS})	
S _{D1} (g)	0.277	2/3(S _{M1})	
Seismic Design Category	D	Table 1613.2.5(1,2)	
Building Height, h _n (ft)	28		
Number of Stories	2		
Light-frame Construction?	No		

Out-of-Plane Forces on Structural Walls and their Anchorage

Component	12.11.1 - Wall Forces		12.11.2 - Anchorage Forces				
	Unit Weight (psf)	Unit Force, f _p (psf)	Diaphragm Length, L _f (ft)	Trib. Wall Height (ft)	Trib. Wall Width (ft)	Amplification Factor, k _a	Wall Anchor Force, F _p (lb)
Log Wall	30	7.7	45	10	2	1.45	223
		-				-	-
		-				-	-
		-				-	-
		-				-	-
		-				-	-
		-				-	-
		-				-	-
		-				-	-
		-				-	-
		-				-	-
		-				-	-
		-				-	-
		-				-	-
		-				-	-



Project: Powder Mountain Lot 80

By: Alex Hawkins, PE

Date: November 2019

Project No.: 9085A

Checked By: DAJ

WIND FORCE ANALYSIS - DIRECTIONAL PROCEDURE

CHAPTER 27 (PART 1), ASCE 7-16

IBC 2018 / ASCE 7-16

Design Parameters

Basic Wind Speed, V (mph)	104	Section 26.5	K _{zt} Factor Applicable?	No	
Exposure Category	C	Section 26.7	Height of Hill or Ridge, H (ft)	N/A	Table 26.8-1
Ground Elevation (ft)	8,557		L _h (ft)	N/A	Table 26.8-1
Enclosure Classification	Enclosed	Section 26.2	H / L _h	0.00	
Positive / Negative?	Positive		x (ft)	N/A	Table 26.8-1
Internal Press. Coef., GC _{pi}	0.18	Table 26.13-1	Horizontal Attenuation, μ	N/A	Table 26.8-1
Mean Roof Height, h (ft)	24		Height Attenuation, γ	N/A	Table 26.8-1
Building Length, L (ft)	70		K ₁ / (H / L _h)	N/A	Table 26.8-1
Building Width, B (ft)	70		K ₁	0.00	Table 26.8-1
L/B	1.00		K ₂	0.00	Table 26.8-1
h/L	0.34		K ₃	0.00	Table 26.8-1
Roof Pitch	1	/12	Topographic Factor, K _{zt} at h	1.00	Section 26.8
Roof Angle, θ	4.8		Wind Directionality Factor, K _d	0.85	Section 26.6
Terrain Constant, α	9.5	Table 26.11-1	Ground Elevation Factor, K _e	0.73	Section 26.9
Terrain Constant, z _g (ft)	900	Table 26.11-1	Gust Effect Factor, G	0.85	Section 26.11
Exposure Coefficient, K _n	0.937	Table 26.10-1	Velocity Pressure, q_n (psf)	16.18	Equation 26.10-1

MWFRS Wind Pressure Analysis

Surface Mark	Surface Type	z (ft)	K _z	Pressure Coefficients, C _p	Walls			Parapets	
					Windward	Leeward	Side	Windward	Leeward
					0.80	-0.50	-0.70	1.50	-1.00
				q _z (psf)	Wind Pressure, p (psf)				
Gable	Wall	24	0.937	16.2	8.09	-9.79	-12.54	-	-
Upper Wall	Wall	15	0.849	14.7	7.05	-9.79	-12.54	-	-
Main Wall	Wall	5	0.849	14.7	7.05	-9.79	-12.54	-	-
			-	-	-	-	-	-	-
			-	-	-	-	-	-	-
			-	-	-	-	-	-	-

Roof Type	Pressure Coefficients, C _p	Roof						Windward Overhang
Monoslope		Not Applicable for Roof Angle		Normal to Ridge for θ < 10° and Parallel to Ridge for all θ				
		Windward	Leeward	0 to h/2	h/2 to h	h to 2h	> 2h	
			-0.77	-0.37	-0.90	-0.90	-0.50	
	-0.18	-0.37	-0.18	-0.18	-0.18	-0.18	0.80	
Surface Mark	Surface Type	Wind Pressure, p (psf)						
Gable	Wall	-	-	-	-	-	-	-
Upper Wall	Wall	-	-	-	-	-	-	-
Main Wall	Wall	-	-	-	-	-	-	-
-		-	-	-	-	-	-	-
-		-	-	-	-	-	-	-
-		-	-	-	-	-	-	-

*Surface Forces**North-South, Positive Internal Pressure*

Surface Mark	Surface Type	Windward or Leeward Surface?	Projected Horizontal Pressure, p (psf)	Tributary Height (ft)	Unit Force (plf)	Surface Width, W (ft)	Force (kips)		
Gable	Wall	Both	17.88	3	53.6	42	2.3		
Upper Wall	Wall	Both	16.84	8	134.8	70	9.4		
Main Wall	Wall	Both	16.84	10	168.4	70	11.8		
-		Both	-	-	-	-	-		
-		Both	-	-	-	-	-	LRFD	ASD
-		Both	-	-	-	-	-	V _x (kips)	0.6V _x (kips)
-		Both	-	-	-	-	-	23.5	14.1



Project: Powder Mountain Lot 80

By: Alex Hawkins, PE

Date: November 2019

Project No.: 9085A

Checked By: DAJ

WIND FORCE ANALYSIS - DIRECTIONAL PROCEDURE

CHAPTER 27 (PART 1), ASCE 7-16

IBC 2018 / ASCE 7-16

Design Parameters

Basic Wind Speed, V (mph)	104	Section 26.5	K _{zt} Factor Applicable?	No	
Exposure Category	C	Section 26.7	Height of Hill or Ridge, H (ft)	N/A	Table 26.8-1
Ground Elevation (ft)	8,557		L _h (ft)	N/A	Table 26.8-1
Enclosure Classification	Enclosed	Section 26.2	H / L _h	0.00	
Positive / Negative?	Positive		x (ft)	N/A	Table 26.8-1
Internal Press. Coef., GC _{pi}	0.18	Table 26.13-1	Horizontal Attenuation, μ	N/A	Table 26.8-1
Mean Roof Height, h (ft)	24		Height Attenuation, γ	N/A	Table 26.8-1
Building Length, L (ft)	70		K ₁ / (H / L _h)	N/A	Table 26.8-1
Building Width, B (ft)	70		K ₁	0.00	Table 26.8-1
L/B	1.00		K ₂	0.00	Table 26.8-1
h/L	0.34		K ₃	0.00	Table 26.8-1
Roof Pitch	1	/12	Topographic Factor, K _{zt} at h	1.00	Section 26.8
Roof Angle, θ	4.8		Wind Directionality Factor, K _d	0.85	Section 26.6
Terrain Constant, α	9.5	Table 26.11-1	Ground Elevation Factor, K _e	0.73	Section 26.9
Terrain Constant, z _g (ft)	900	Table 26.11-1	Gust Effect Factor, G	0.85	Section 26.11
Exposure Coefficient, K _n	0.937	Table 26.10-1	Velocity Pressure, q_n (psf)	16.18	Equation 26.10-1

MWFRS Wind Pressure Analysis

Surface Mark	Surface Type	z (ft)	K _z	Pressure Coefficients, C _p	Walls			Parapets	
					Windward	Leeward	Side	Windward	Leeward
					0.80	-0.50	-0.70	1.50	-1.00
				q _z (psf)	Wind Pressure, p (psf)				
Upper Wall	Wall	15	0.849	14.7	7.05	-9.79	-12.54	-	-
Main Wall	Wall	5	0.849	14.7	7.05	-9.79	-12.54	-	-
			-	-	-	-	-	-	-
			-	-	-	-	-	-	-
			-	-	-	-	-	-	-
			-	-	-	-	-	-	-

Roof Type	Pressure Coefficients, C _p	Roof						Windward Overhang
		Not Applicable for Roof Angle		Normal to Ridge for θ < 10° and Parallel to Ridge for all θ				
		Windward	Leeward	0 to h/2	h/2 to h	h to 2h	> 2h	
Monoslope		-0.77	-0.37	-0.90	-0.90	-0.50	-0.30	
		-0.18	-0.37	-0.18	-0.18	-0.18	-0.18	0.80
Surface Mark	Surface Type	Wind Pressure, p (psf)						
Upper Wall	Wall	-	-	-	-	-	-	-
Main Wall	Wall	-	-	-	-	-	-	-
-		-	-	-	-	-	-	-
-		-	-	-	-	-	-	-
-		-	-	-	-	-	-	-

Surface Forces

East-West, Positive Internal Pressure

Surface Mark	Surface Type	Windward or Leeward Surface?	Projected Horizontal Pressure, p (psf)	Tributary Height (ft)	Unit Force (plf)	Surface Width, W (ft)	Force (kips)		
Upper Wall	Wall	Both	16.84	8	134.8	78	10.5		
Main Wall	Wall	Both	16.84	10	168.4	78	13.1		
-		Both	-		-		-		
-		Both	-		-		-		
-		Both	-		-		-	LRFD	ASD
-		Both	-		-		-	V _x (kips)	0.6V _x (kips)
-		Both	-		-		-	23.6	14.2



Project: Powder Mountain Lot 80

By: Alex Hawkins, PE

Date: November 2019

Project No.: 9085A

Checked By: DAJ

WIND FORCE ANALYSIS - COMPONENTS & CLADDING

CHAPTER 30, ASCE 7-16

IBC 2018 / ASCE 7-16

Design Parameters

Basic Wind Speed, V (mph)	104	Section 26.5	K _{zt} Factor Applicable?	No	
Exposure Category	C	Section 26.7	Height of Hill or Ridge, H (ft)	N/A	Table 26.8-1
Ground Elevation (ft)	8,557		L _h (ft)	N/A	Table 26.8-1
Enclosure Classification	Enclosed	Section 26.2	H / L _h	0.00	
Positive / Negative?	Positive		x (ft)	N/A	Table 26.8-1
Internal Press. Coef., GC _{pi}	0.18	Table 26.13-1	Horizontal Attenuation, μ	N/A	Table 26.8-1
Mean Roof Height, h (ft)	24		Height Attenuation, γ	N/A	Table 26.8-1
Building Length, L (ft)	78		K ₁ / (H / L _h)	N/A	Table 26.8-1
Building Width, B (ft)	70		K ₁	0.00	Table 26.8-1
h/B	0.34		K ₂	0.00	Table 26.8-1
Roof Type	Monoslope		K ₃	0.00	Table 26.8-1
Roof Pitch	1	/12	Topographic Factor, K _{zt} at h	1.00	Section 26.8
Roof Angle, θ	4.8		Wind Directionality Factor, K _d	0.85	Section 26.6
Is there a Parapet?	No		Ground Elevation Factor, K _e	0.73	Section 26.9
Parapet Height, h _p (ft)	N/A		Velocity Pressure, q_h (psf)	16.18	Equation 26.10-1
Terrain Constant, α	9.5	Table 26.11-1	Exposure Coefficient, K _p	N/A	Table 26.10-1
Terrain Constant, z _g (ft)	900	Table 26.11-1	Topographic Factor, K _{zt} at h _p	N/A	Section 26.8
Exposure Coefficient, K _h	0.937	Table 26.10-1	Velocity Pressure, q_p (psf)	N/A	Equation 26.10-1

External Pressure Coefficients, GC_p

Location		TRIBUTARY AREA (ft ²)				
		< 10	20	50	100	>500
Walls	Zone 5: Within 7-ft of building corner	-1.3	-1.2	-1.0	-0.9	-0.7
	Zone 4: All other areas	-1.0	-0.9	-0.9	-0.8	-0.7
	Zone 4 & 5: Positive Pressures	0.9	0.9	0.8	0.7	0.6
Roof	Zone 3': Within 14-ft of upper roof ridge & within 28-ft of roof side	-2.6	-2.3	-1.9	-1.6	-1.6
	Zone 3: Within 14-ft of lower roof corners	-1.8	-1.7	-1.4	-1.2	-1.2
	Zone 2': Within 14-ft of upper roof edge & side edges	-1.6	-1.6	-1.6	-1.5	-1.5
	Zone 2: Within 7-ft of lower roof edge	-1.3	-1.4	-1.3	-1.2	-1.2
	Zone 1: Roof field	-1.1	-1.1	-1.1	-1.1	-1.1
All Zones: Positive Pressures		0.3	0.3	0.2	0.2	0.2

Component & Cladding Design Wind Pressure

Location		Tributary Area (ft ²)				
		< 10	20	50	100	>500
Walls	Zone 5: Within 7-ft of building corner	-23.3	-21.8	-19.7	-18.2	-16.0
	Zone 4: All other areas	-18.9	-18.2	-17.5	-16.4	-16.0
	Zone 4 & 5: Positive Pressures	16.0	16.0	16.0	16.0	16.0
Roof	Zone 3': Within 14-ft of upper roof ridge & within 28-ft of roof side	-45.0	-40.1	-33.7	-28.8	-28.8
	Zone 3: Within 14-ft of lower roof corners	-32.0	-29.6	-25.6	-22.3	-22.3
	Zone 2': Within 14-ft of upper roof edge & side edges	-28.8	-28.8	-28.0	-27.2	-27.2
	Zone 2: Within 7-ft of lower roof edge	-23.9	-25.2	-23.1	-22.3	-22.3
	Zone 1: Roof field	-20.7	-20.7	-20.7	-20.7	-20.7
All Zones: Positive Pressures		16.0	16.0	16.0	16.0	16.0
Parapets	N/A	A	-	-	-	-
		B	-	-	-	-
	N/A	A	-	-	-	-
		B	-	-	-	-

Search Information

Address: 8483 E. Spring Park Summit Powder Mountain Resort
Coordinates: 41.378963, -111.780685
Elevation: ft
Timestamp: 2019-10-01T22:27:52.542Z
Hazard Type: Wind



ASCE 7-16

MRI 10-Year 74 mph
 MRI 25-Year 80 mph
 MRI 50-Year 85 mph
 MRI 100-Year 90 mph
 Risk Category I 98 mph
 Risk Category II 104 mph
 Risk Category III 110 mph
 Risk Category IV 114 mph

ASCE 7-10

MRI 10-Year 76 mph
 MRI 25-Year 84 mph
 MRI 50-Year 90 mph
 MRI 100-Year 96 mph
 Risk Category I 105 mph
 Risk Category II 115 mph
 Risk Category III-IV 120 mph

ASCE 7-05

ASCE 7-05 Wind Speed 90 mph

The results indicated here DO NOT reflect any state or local amendments to the values or any delineation lines made during the building code adoption process. Users should confirm any output obtained from this tool with the local Authority Having Jurisdiction before proceeding with design.

Disclaimer

Hazard loads are interpolated from data provided in ASCE 7 and rounded up to the nearest whole integer. Per ASCE 7, islands and coastal areas outside the last contour should use the last wind speed contour of the coastal area – in some cases, this website will extrapolate past the last wind speed contour and therefore, provide a wind speed that is slightly higher. NOTE: For queries near wind-borne debris region boundaries, the resulting determination is sensitive to rounding which may affect whether or not it is considered to be within a wind-borne debris region.

Mountainous terrain, gorges, ocean promontories, and special wind regions shall be examined for unusual wind conditions.

While the information presented on this website is believed to be correct, ATC and its sponsors and contributors assume no responsibility or liability for its accuracy. The material presented in the report should not be used or relied upon for any specific application without competent examination and verification of its accuracy, suitability and applicability by engineers or other licensed professionals. ATC does not intend that the use of this information replace the sound judgment of such competent professionals, having experience and knowledge in the field of practice, nor to substitute for the standard of care required of such professionals in interpreting and applying the results of the report provided by this website. Users of the information from this website assume all liability arising from such use. Use of the output of this website does not imply approval by the governing building code bodies responsible for building code approval and interpretation for the <https://hazards.atcouncil.org/#!/wind?lat=41.378963&lng=-111.780685&address=8483 E. Spring Park Summit Powder Mountain Resort>

and these data not imply approval by the governing building code bodies responsible for building code approval and interpretation for the building site described by latitude/longitude location in the report.

2018 Utah Ground Snow Load Map

Lot 8U 64677 2018



Latitude: 41.363
 Longitude: -111.747
 Elevation: 8,557 ft

Ground Snow Load:
 384 psf / 18.43 kPa

269 psf ROOF SNOW LOAD

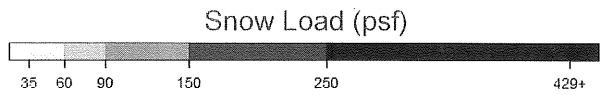
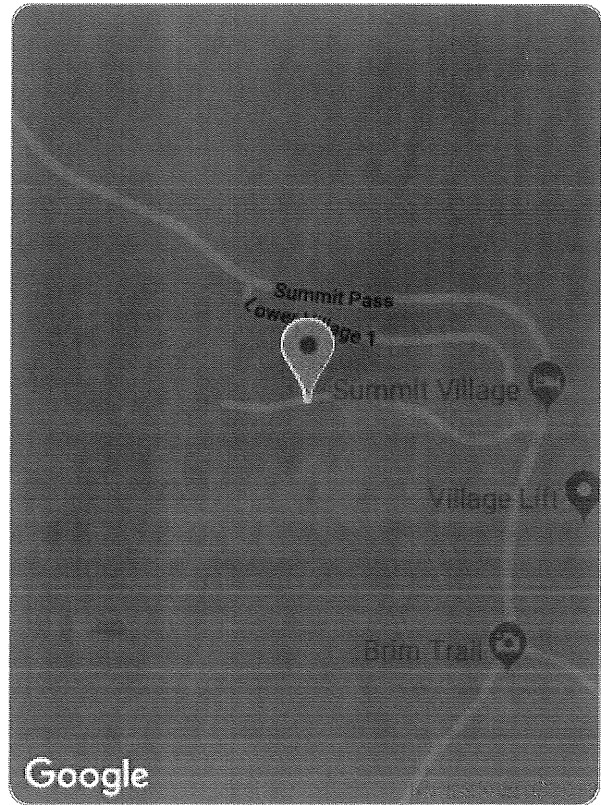

*This document is not legally binding. The user is urged to verify ground snow load values with the local authority having jurisdiction.

These ground snow load values represent 50-year ground snow load estimated value at a 2% probability of exceedance for the location given. The grid used in the map is 3350ft by 3350ft. Elevations for these grid cells were estimated by aggregating data from 100ft by 100ft USGS digital elevation models and may not coincide with the actual site elevation. These predictions are calculated using the process outlined in The Utah Snow Load Study.¹

Final predictions given are bounded at a lower limit for a minimum ground snow load of 21 psf to meet ASCE 7. Estimated values for snow loads at elevations significantly higher than all nearby stations lead to unreasonably high snow load estimates, therefore, the predictions in the map are not allowed to extend beyond the highest 50-year station ground snow load of 429 psf. Elevations over 9,000 ft are also considered less accurate due to the limited number of stations at these elevations. The results shown in this report have included a warning if the results have reached or exceeded the upper limit.

While great efforts have been made to ensure these predictions are as accurate as possible, designers must use expert judgement to ensure that such predictions are appropriate for their particular project. The SEAU and the authors cannot accept responsibility for prediction errors or any consequences resulting therefrom.

¹ Bean, Brennan; Maguire, Marc; and Sun, Yan, "The Utah Snow Load Study" (2018). Civil and Environmental Engineering Faculty Publications. Paper 3589.



Project: Powder Mountain Lot 80

By: Alex Hawkins, PE

Date: November 2019

Project No.: 9085A

Checked By: DAJ

SHEAR WALL SCHEDULE

CHAPTER 4.3, AWC SDPWS-2015

IBC 2018 / ASCE 7-16

Mark	Nailing Requirements (in)		Notes	V _{allow} (8) Seismic (plf)	V _{allow} (8) Wind (plf)	Sole Plate Nailing (10 & 13) (Sole Plate to 2x blocking or rim)
	Edge	Field				
SW1	6	12	1,2,3	260	365	16d common @ 6" o.c.
SW2	4	12	1,2,3	350	490	16d common @ 4" o.c.
SW3	4	12	1,2,3,4	380	532	16d common @ 4" o.c.
SW4	3	12	1,2,3,4	490	685	(2) 16d common @ 6" o.c.
SW5	2	12	1,2,3,4	640	895	(2) 16d common @ 6" o.c.
SW6	2	12	1,3,4,6	770	1078	(2) 16d common @ 4" o.c.
SW7	3	12	1,2,3,4,5	980	1370	(2) SDS screws @ 6" o.c.
SW8	2	12	1,2,3,4,5,11	1280	1790	(2) SDS screws @ 4" o.c.
SW9	2	12	1,3,4,5,6,11	1540	2155	(2) SDS screws @ 4" o.c.
SW10	2	12	1,3,4,5,7,11	1740	2435	(2) SDS screws @ 3" o.c.

- Notes:
- 16 inch o.c. max stud spacing or panels applied with the long dimension across the studs per AF&PA SDPWS table 4.3A note 2.
 - 7/16" APA rated sheathing panel with 8d common or galvanized box nails.
 - Block all edges.
 - 3" nominal framing at abutting panel edges (AF&PA SDPWS 4.3.7.1.5.c)
 - Sheathing applied to both sides of wall
 - 15/32" APA rated sheathing with 10d common or galvanized box nails
 - 15/32" APA Structural I rated sheathing with 10d common or galvanized box nails
 - Allowable shear values per AF&PA SDPWS table 4.3A.
 - For all walls, provide hot dipped zinc-coated galvanized steel, stainless steel, silicon bronze or copper nails at preservative-treated and fire-retardant-treated wood locations.
 - SDS screws to be 4.5" minimum length and penetrate 2" into rim board or blocking
 - SDS screws must be into 2x DFL blocking or 2x DFL rim board (not LVL or LSL)
 - Where panels are applied to both faces of the wall and nail spacing is less than 6" on center on either side offset panel joints to different framing members.
 - If (2) SDS screws are required on the sole plate nailing 2x blocking must be provided adjacent to rimboard or (2) 2x blocks must be provided. SDS screws require 5/8" edge and 3" end distance.

STAPLE EQUIVALENCY CHART

Staple Type	Stapling Requirements		V _{allow} (8) Seismic (plf)	Equivalent to Nailed Shearwall designated above:	V _{allow} (8) Wind (plf)	Equivalent to Nailed Shearwall designated above:
	Edge	Field				
16 Gage 1/2" Staples	6"	6"	155	NONE	215	NONE
	4"	6"	230	NONE	320	NONE
	3"	6"	310	SW1	435	SW1
	2"	6"	395	SW2 and SW3	555	SW2 and SW3

- Notes:
- Minimum staple penetration into main member is 1".
 - Staples shall have a minimum crown width of 7/16".
 - Install staple crown parallel to the long dimension of the framing member.
 - Where staple spacing is 2" or less, framing at adjoining panel edges shall be 3" nominal.
 - Provide 3/8" distance from panel edge to staple.
 - Table valid for shearwalls only.
 - Provide hot dipped zinc-coated galvanized steel, stainless steel, silicon bronze or copper staples at preservative-treated and fire-retardant-treated wood locations.
 - Allowable shear values per ICC-ES Evaluation Report ESR-1539 and IBC 2018 Table 2306.3(1).
 - Allowable shear values shown are based on 7/16" nominal sheathing thickness.



Project: Powder Mountain Lot 80
 By: Alex Hawkins, PE
 Date: November 2019

Project No.: 9085A
 Checked By: DAJ

WOOD SHEAR WALLS

CHAPTER 4.3, AWC SDPWS-2015

IBC 2018 / ASCE 7-16

NOTES: 1. Typically when seismic is found to govern wind loads will not be checked here. However, if wind loads are found to govern both wind and seismic need to be checked in order to account for the difference in shearwall capacities.
 2. ASD loads are to be entered here.

$S_{DS} =$	0.64
$I_e =$	1.00
$C_d =$	4

Loft <u>East Wall</u>	Wind Force on Wall Line: [] lbs Seismic Force on Wall Line: 5,445 lbs	lbs / Dowel: 2,750 # of Dowels: 3	Total: 8,250 lbs OK
Loft <u>West Wall</u>	Wind Force on Wall Line: [] lbs Seismic Force on Wall Line: 5,445 lbs	lbs / Dowel: 2,750 # of Dowels: 2	Total: 5,500 lbs OK
Loft <u>North Wall</u>	Wind Force on Wall Line: [] lbs Seismic Force on Wall Line: 5,445 lbs	lbs / Dowel: 2,750 # of Dowels: 3	Total: 8,250 lbs OK
Loft <u>South Wall</u>	Wind Force on Wall Line: [] lbs Seismic Force on Wall Line: 5,445 lbs	lbs / Dowel: 2,750 # of Dowels: 2	Total: 5,500 lbs OK
Grid 1 <u>Main Floor</u>	Wind Force on Wall Line: [] lbs Seismic Force on Wall Line: 16,424 lbs	lbs / Dowel: 2,750 # of Dowels: 6 Length (ft): 37	Total: 16,500 lbs OK Anchor Bolts: AB32
Grid 2 <u>Main Floor</u>	Wind Force on Wall Line: [] lbs Seismic Force on Wall Line: 16,500 lbs SW-10 28,294	lbs / Dowel: 2,750 # of Dowels: 6 Length (ft): 17	Total: 16,500 lbs OK Anchor Bolts: AB16
Grid 3 <u>Main Floor</u>	Wind Force on Wall Line: [] lbs Seismic Force on Wall Line: 13,438 lbs Concrete Shear Walls	lbs / Dowel: 2,750 # of Dowels: 0 Length (ft): 0	Total: 0 lbs NG Anchor Bolts: #DIV/0!
Grid A <u>Main Floor</u>	Wind Force on Wall Line: [] lbs Seismic Force on Wall Line: 13,625 lbs	lbs / Dowel: 2,750 # of Dowels: 5 Length (ft): 15	Total: 13,750 lbs OK Anchor Bolts: AB16
Grid B <u>Main Floor</u>	Wind Force on Wall Line: [] lbs Seismic Force on Wall Line: 22,579 lbs	lbs / Dowel: 2,750 # of Dowels: 9 Length (ft): 10	Total: 24,750 lbs OK Anchor Bolts: Add Wall
Grid C <u>Main Floor</u>	Wind Force on Wall Line: [] lbs Seismic Force on Wall Line: 25,304 lbs	lbs / Dowel: 2,750 # of Dowels: 10 Length (ft): 24	Total: 27,500 lbs OK Anchor Bolts: AB16
Grid D <u>Main Floor</u>	Wind Force on Wall Line: [] lbs Seismic Force on Wall Line: 16,350 lbs	lbs / Dowel: 2,750 # of Dowels: 6 Length (ft): 13	Total: 16,500 lbs OK Anchor Bolts: AB8



Project: Powder Mountain Lot 80
By: Alex Hawkins, PE
Date: November 2019

Project No.: 9085A
Checked By: DAJ

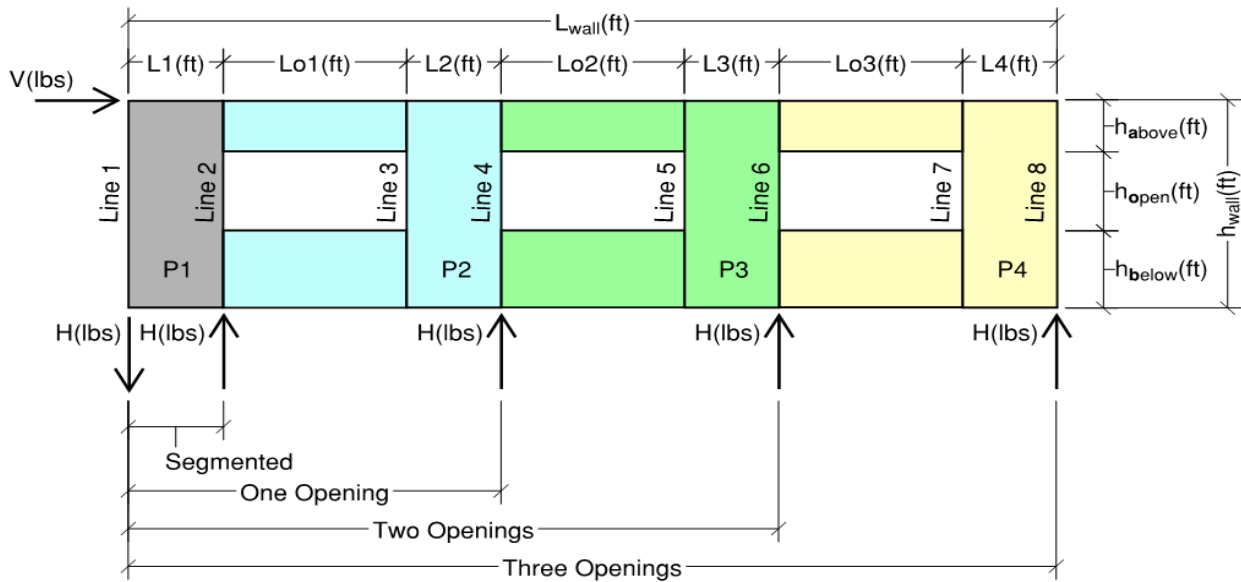

444

1000

####

908.3

2258

1077

1258



Project: Powder Mountain Lot 80
 By: Alex Hawkins, PE
 Date: November 2019

Project No.: 9085A
 Checked By: DAJ

Grid 2 Wind Force on Wall Line: _____ lbs
 Seismic Force on Wall Line: 28,294 lbs

1st Floor

Wall ID	# of Walls	SEG or PSW or FTAO	Wall Segment and Opening Lengths							Length (ft)	Wall Height (ft)	Proportions of Wall Height			H:W Ratio	Aspect Ratio Reduct.	Effective Length (2b _y /h)*L	Co, PSW Reduct.
			L1 (ft)	Lo1 (ft)	L2 (ft)	Lo2 (ft)	L3 (ft)	Lo3 (ft)	L4 (ft)			ha (ft)	ho (ft)	hb (ft)				
1	1	SEG	17.00							17.00	11.00			11.0	0.65	1.00	17.00	1.00

Grid 2.4 Wind Force on Wall Line: _____ lbs
 Seismic Force on Wall Line: 2,680 lbs

Basement

Wall ID	# of Walls	SEG or PSW or FTAO	Wall Segment and Opening Lengths							Length (ft)	Wall Height (ft)	Proportions of Wall Height			H:W Ratio	Aspect Ratio Reduct.	Effective Length (2b _y /h)*L	Co, PSW Reduct.
			L1 (ft)	Lo1 (ft)	L2 (ft)	Lo2 (ft)	L3 (ft)	Lo3 (ft)	L4 (ft)			ha (ft)	ho (ft)	hb (ft)				
1	1	SEG	3.00							3.00	9.50			9.5	3.17	0.63	1.89	1.00
2	1	SEG	5.50							5.50	9.50			9.5	1.73	1.00	5.50	1.00

Grid B (3 Dowels) Wind Force on Wall Line: _____ lbs
 Seismic Force on Wall Line: 5,428 lbs

Basement

Wall ID	# of Walls	SEG or PSW or FTAO	Wall Segment and Opening Lengths							Length (ft)	Wall Height (ft)	Proportions of Wall Height			H:W Ratio	Aspect Ratio Reduct.	Effective Length (2b _y /h)*L	Co, PSW Reduct.
			L1 (ft)	Lo1 (ft)	L2 (ft)	Lo2 (ft)	L3 (ft)	Lo3 (ft)	L4 (ft)			ha (ft)	ho (ft)	hb (ft)				
1	1	SEG	5.00							5.00	9.50			9.5	1.90	1.00	5.00	1.00



Project: Powder Mountain Lot 80

By: Alex Hawkins, PE

Date: November 2019

Project No.: 9085A

Checked By: DAJ

Grid 2**1st Floor**

Wall ID	Total Length (ft)	Uniform DL (plf)	Wind Uplift (lb)	Seismic Uplift (lb)	FTAO Strap Force	Req'd FTAO Strap	Wind Shear (plf)	Seismic Shear (plf)	Use Shear Wall	Holdown Type	Holdown Required	Allowable Story Drift Seismic (in)	Shear Wall Drift Seismic (in)	Wind Deflection Limit (in)	Shear Wall Deflection Wind (in)
1	17.00	1032	0	14109	NA	NA	0	1664	SW10	Concrete Rod	H-7	2.640	1.587	0.733	0.000

Anchor Bolt Size (inches): 5/8

Anchor Bolt Designation: AB8

Grid 2.4**Basement**

Wall ID	Total Length (ft)	Uniform DL (plf)	Wind Uplift (lb)	Seismic Uplift (lb)	FTAO Strap Force	Req'd FTAO Strap	Wind Shear (plf)	Seismic Shear (plf)	Use Shear Wall	Holdown Type	Holdown Required	Allowable Story Drift Seismic (in)	Shear Wall Drift Seismic (in)	Wind Deflection Limit (in)	Shear Wall Deflection Wind (in)
1	1.89	390	0	3605	NA	NA	0	362	SW3	STHD MID	H-13	2.280	2.654	0.633	0.000
2	5.50	390	0	3083	NA	NA	0	362	SW3	STHD MID	H-12	2.280	1.866	0.633	0.000

Anchor Bolt Size (inches): 5/8

Anchor Bolt Designation: AB32

Grid B (3 Dowels)**Basement**

Wall ID	Total Length (ft)	Uniform DL (plf)	Wind Uplift (lb)	Seismic Uplift (lb)	FTAO Strap Force	Req'd FTAO Strap	Wind Shear (plf)	Seismic Shear (plf)	Use Shear Wall	Holdown Type	Holdown Required	Allowable Story Drift Seismic (in)	Shear Wall Drift Seismic (in)	Wind Deflection Limit (in)	Shear Wall Deflection Wind (in)
1	5.00	743.9	0	10032	NA	NA	0	1086	SW8	Concrete Rod	H-6	2.280	1.804	0.633	0.000

Anchor Bolt Size (inches): 5/8

Anchor Bolt Designation: AB16



Project: Powder Mountain Lot 80

By: Alex Hawkins, PE

Date: November 2019

Project No.: 9085A

Checked By: DAJ

HOLDOWN & VERTICAL STRAP SCHEDULE

IBC 2018 / ASCE 7-16

HOLDOWN INTO CONCRETE							
Mark	Anchor	Wind or Seismic Capacity (LBS)	Rod Diameter	Min. Post Size	Minimum Embed Depth in Footing	Edge Distance	Post Grade
H-1	HTT4 w/ (18) 10dx1½ nails	3610	5/8"	3" x 3 1/2"	6 1/2"	10"	DF #2
H-2	HTT5 w/ (26) 10d nails	4670	5/8"	3" x 3 1/2"	6 1/2"	10"	DF #2
H-3	HDU5 - SDS2.5 (14)	5645	5/8"	4 1/2" x 3 1/2"	6 1/2"	10"	DF #2
H-4	HDU8 - SDS2.5 (20)	7870	7/8"	4 1/2" x 3 1/2"	9"	13 1/2"	DF #2
H-5	HDU11 - SDS2.5 (30)	9335	1"	5 1/2" x 3 1/2"	11"	16 1/2"	DF #2
H-6	HDU11 - SDS2.5 (30)	11175	1"	7 1/4" x 3 1/2"	11"	16 1/2"	DF #2
H-7	HDU14 - SDS2.5 (36)	14390	1"	5.5"sq or 9.25"	11"	16 1/2"	DF #2
H-8	HD12 (4) 1" Bolts	15435	1 1/8"	5.5"sq or 9.25"	12 1/2"	19"	DF #2
H-9	HD19 (1 1/8") & (5) 1" Bolts	16735	1 1/8"	5 1/2" x 5 1/2"	12 1/2"	19"	DF #1
H-10	HD19 (1 1/4") & (5) 1" Bolts	19070	1 1/4"	5 1/2" x 5 1/2"	14 1/2"	22"	DF #1

HOLDOWN INTO CONCRETE (Single Family Residential ONLY)								
Mark	Anchor	Wind Capacity (LBS) - Cracked			Seismic Capacity (LBS) - Cracked			Min. Post Size
		Midwall	Corner	Endwall	Midwall	Corner	Endwall	
H-11	LSTHD8	2675	2320	1915	2250	1950	1610	3" x 3 1/2"
H-12	STHD10	4195	3500	2585	3400	2940	2175	3" x 3 1/2"
H-13	STHD14	5345	5345	4210	3815	3815	3500	3" x 3 1/2"

FLOOR TO FLOOR TIES (STRAPS OR RODS)					
Mark	Anchor	Wind or Seismic Capacity (LBS)	Rod Diameter	Min. Post Size	Post Grade
Strap Type					
T-1	CS16 - (20) - 11"	1705	NA	1 1/2" x 3 1/2"	DF #2
T-2	CS14 - (26) - 15"	2490	NA	3" x 3 1/2"	DF #2
T-3	CMSTC16 - (50) - 20"	4585	NA	3" x 3 1/2"	DF #2
T-4	CMST14 - (66) - 30"	6490	NA	4 1/2" x 3 1/2"	DF #2
T-5	CMST12 - (86) - 39"	9215	NA	5 1/2" x 3 1/2"	DF #2
Rod Type					
T-6	HDU2-SDS2.5 (6)	3075	5/8"	3" x 3 1/2"	DF #2
T-7	HTT4 w/ (18) 10dx1½ nails	3610	5/8"	3" x 3 1/2"	DF #2
T-8	HTT5 w/ (26) 10d nails	4670	5/8"	3" x 3 1/2"	DF #2
T-9	HDU5 - SDS2.5 (14)	5645	5/8"	4 1/2" x 3 1/2"	DF #2
T-10	HDU8 - SDS2.5 (20)	7870	7/8"	4 1/2" x 3 1/2"	DF #2
T-11	HDU11 - SDS2.5 (30)	9335	1"	5 1/2" x 3 1/2"	DF #2
T-12	HDU11 - SDS2.5 (30)	11175	1"	7 1/4" x 3 1/2"	DF #2
T-13	HDU14 - SDS2.5 (36)	14390	1"	5.5"sq or 9.25"	DF #2
T-14	HD12 (4) 1" Bolts	15435	1 1/8"	5.5"sq or 9.25"	DF #2
T-15	HD19 (1 1/8") & (5) 1" Bolts	16735	1 1/8"	5 1/2" x 5 1/2"	DF #1
T-16	HD19 (1 1/4") & (5) 1" Bolts	19070	1 1/4"	5 1/2" x 5 1/2"	DF #1
T-17	(2) HDU4-SDS2.5 (20)	9130	5/8"	5 1/2" x 3 1/2"	DF #2

Notes:

All anchors are Simpson Strong-Tie. Install per manufacturer's specifications.

All capacities shown are ASD. All min. post sizes are based on 9 ft max nominal top plate heights. For 8ft use 7.25" for H-7&8, T-13&14 and 4x10 for H-9&10, T-15&16. Use 4" end distance at foundation blockouts.

CS and CMST straps are specified with: strap type - total # of of 10d nails required - end length required onto the studs. CMSTC16 Strap uses 16d Sinker Nails.

Provide 1/2" X 1 3/4" X 1 3/4" plate washer for 5/8" dia. anchors, 1/2" X 2 1/2" X 2 1/2" plate washer for 7/8" dia. anchors, 5/8" X 3" X 2 3/4" plate washer for 1" dia.

anchors, 5/8" X 3 1/2" X 3 1/4" plate washer for 1 1/8" dia. anchors, and 3/4" X 3 1/2" X 3 1/2" plate washer for 1 1/4" dia. anchors. Provide nut top & bot.

For stem wall applications use simpsom SB 5/8" x 24" embed 18" min. in wall for HTT4, HTT5, HDU5 holdowns. HDU8 may use SB 7/8" x 24" at midwall.

Ensure that the Min. Edge distances are met for all anchors in concrete.

Min. anchor bolt strength is ASTM F-1554 GRADE 36 U.N.O.

LSTHD's and STHD's assume 8" stemwalls minimum.



Project: Powder Mountain Lot 80

By: Alex Hawkins, PE

Date: November 2019

Project No.: 9085A

Checked By: DAJ

ANCHOR BOLTS

2018 NDS Table 12E

1/2" Diameter Anchor Bolts		
Mark	Bolt Spacing	Capacity (plf)
AB32	32"	384
AB24	24"	512
AB16	16"	768
AB12	12"	1024
AB8	8"	1536

5/8" Diameter Anchor Bolts		
Mark	Bolt Spacing	Capacity (plf)
AB32	32"	552
AB24	24"	736
AB16	16"	1104
AB12	12"	1472
AB8	8"	2208

- Notes:
- 7" minimum embedment depth on all anchor bolts.
 - 3" x 3" x 0.229" plate washers on all anchor bolts. 1/2" away from sheathing.
 - (2) anchor bolts min. per shear wall.
 - Anchors are located a minimum of 1 3/4" away from the edge of concrete
 - Anchor bolts are to be located 15 anchor diameters away from a concrete edge that is perpendicular to the sill plate.
 - Sill plate is 2x or 3x minimum. (Capacities shown here are based on a 2x sill plate)



Project: Powder Mountain Lot 80

By: Alex Hawkins, PE

Date: November 2019

Project No.: 9085A

Checked By: DAJ

ROOF FRAMING

NDS 2018 EDITION

IBC 2018 / ASCE 7-16

Roof Trusses:

Use pre-engineered trusses @ 24" o.c.
 Provide truss blocking as shown on plans and per manufacturer's specifications.
 All truss connection hardware to be designed by the truss manufacturer.
 Provide full depth blocking at all bearing locations with (1) A35 clip to top plate per block U.N.O.
 Nail through sheathing with 8d common @ 4" o.c. into blocking U.N.O.
 Provide "H1" clips at both ends of every truss U.N.O.

Roof Stick Frame:

Use roof joists per span chart.
 Provide full depth blocking at all bearing locations with (1) A35 clip to top plate per block UNO.
 Nail through sheathing with 8d common @ 4" o.c. into blocking U.N.O.
 Provide "H1" clips at both ends of every joist UNO.

Roof Overbuild:

Frame roof overbuild areas with 2x6 DF#2 @ 24" o.c.
 Brace joists at 6' 0" o.c.
 Use 2x8 DF#2 ridge board braced at 4' 0" o.c.
 Use 2x8 DF#2 valley members laid flat and nailed to trusses with (2) 16d per truss.
 Brace ridge and joists such that load is distributed uniformly to trusses below.
 Sheath under all overbuild areas.
 Provide access and ventilation to overbuild areas as necessary.

Roof Beams:

See attached beam calculations.

Roof Sheathing:

Provide 5/8" or thicker 24/16 APA rated panel.
 Nail with 8d common at 6" o.c. at panel edge and 12" o.c. in the field.
 Provide 'H' clips at all unsupported edges.
 Provide 1/8" gap between panels at time of installation.



Project: Powder Mountain Lot 80

By: Alex Hawkins, PE

Date: November 2019

Project No.: 9085A

Checked By: DAJ

STUD COLUMN DESIGN

NDS 2018 EDITION

IBC 2018 / ASCE 7-16

Species = DFLN Stud
 Height = 8.0 ft
 Fc = 900 psi
 E = 1400 ksi
 Kce = 0.3 psi
 c = 0.8 psi

Size =	2x4	2x6	
d =	3.50	5.25	in
Fce =	558.27	1256.10	psi
Cp =	0.51	0.79	
F'c =	461.27	712.89	psi

Height	(2) 2x4	(3) 2x4	(4) 2x4	(5) 2x4	(6) 2x4	(7) 2x4	
8 ft	4.8	7.3	9.7	12.1	14.5	17.0	kips
9 ft	4.0	6.0	8.1	10.1	12.1	14.1	kips
10 ft	3.4	5.1	6.8	8.4	10.1	11.8	kips
12 ft	2.4	3.7	4.9	6.1	7.3	8.5	kips
18 ft	1.1	1.7	2.3	2.8	3.4	3.9	kips

Height	(2) 2x6	(3) 2x6	(4) 2x6	(5) 2x6	(6) 2x6	(7) 2x6	
8 ft	11.2	16.8	22.5	28.1	33.7	39.3	kips
9 ft	10.3	15.4	20.5	25.6	30.8	35.9	kips
10 ft	9.2	13.8	18.4	23.1	27.7	32.3	kips
12 ft	7.3	10.9	14.5	18.2	21.8	25.4	kips
18 ft	3.7	5.5	7.3	9.1	11.0	12.8	kips

SOLID POSTS

Species = DFLN #1
 Height = 8.0 ft
 Fc = 925 psi
 E = 1600 ksi
 Kce = 0.3 psi
 c = 0.8 psi

Size =	4x4	4X6	6x6	
d =	3.5	3.5	5.5	in
Fce =	638.02	638.02	1575.52	psi
Cp =	0.553	0.553	0.838	
F'c =	511.49	511.49	774.96	psi

Height	4x4	4X6	6x6	
8 ft	6.3	9.8	23.4	kips
9 ft	5.6	8.8	21.9	kips
10 ft	4.7	7.3	20.1	kips
12 ft	3.3	5.2	16.5	kips
18 ft	1.5	2.4	8.6	kips



Project: Powder Mountain Lot 80

By: Alex Hawkins, PE

Date: November 2019

Project No.: 9085A

Checked By: DAJ

STANDARD FOUNDATION WALLS

ACI 318-14

IBC 2018 / ASCE 7-16

Foundation Schedule			Horizontal Reinforcement		Vertical Reinforcement	
Mark	Wall Height	Thickness	Size	Spacing	Size	Spacing
Typ.	4'	8"	#4	18"	#4	24"
Typ.	8'	8"	#4	18"	#4	24"
Typ.	9'	8"	#4	18"	#4	16"
Typ.	10'	8"	#4	18"	#5	12"

Notes: Wall height refers to final grade difference through the wall. Total height of wall may be higher due to footing drop for frost protection or native soil bearing as long as wall is backfilled such that the grade difference does not exceed the wall height at any time during construction.

ALL REBAR TO BE GRADE 60.

Place vertical bars in the center of wall.

Extend vertical bars from the footing to within 3" of the top of wall.

Provide #4 dowel with standard hook in the footing to match the vertical rebar.

Extend vertical leg of dowel 24" min. into wall.

Place (1) #4 horizontally within 4" of top and bottom of wall.

Provide corner reinforcing so as to lap 24" min.

Provide (2) #4 above, (1) #4 each side, and (1) #4 below all openings.

Place steel within 2" of openings & extend 24" min. beyond edge of opening.

Vertical bars around openings may terminate 3" from top of wall.



Current Date: 11/14/2019 12:42 PM

Units system: English

File name: P:\9085A Pow Mow Lot 80 Scandinavian\Structural Calcs\Concrete Wall.cwd\

Design Results

Concrete Wall

GENERAL INFORMATION:

Global status : Warnings in design

Design code : ACI 318-14

Geometry:

Total height : 28.00 [ft]

Total length : 2.33 [ft]

Base support type : Continuous

Wall bottom restraint : Fixed

Column bottom restraint : Fixed

Rigidity elements : None

Materials:

Material : C 4-60

Steel tension strength (Fy) : 60 [Kip/in²]

Concrete compressive strength (fc) : 4 [Kip/in²]

Steel elasticity modulus (Es) : 29000 [Kip/in²]

Concrete modulus of elasticity (E) : 3605 [Kip/in²]

Concrete unit weight : 0.149818 [Kip/ft³]

Number of stories: 2

Story	Story height [ft]	Wall thickness [in]
1	10.50	8.00
2	14.50	8.00

Load conditions:

ID	Comb.	Category	Description
DL	No	DL	Dead Load
SL	No	SNOW	Snow Load
LL	No	LL	Live Load
EQ	No	EQ	Earthquake Load
SC1	Yes		DL
DC1	Yes		1.4DL
D1	Yes		1.4DL
D2	Yes		1.2DL+1.6LL
D3	Yes		1.2DL+0.5SL
D4	Yes		1.2DL+1.6LL+0.5SL
D5	Yes		1.2DL+1.6SL
D6	Yes		1.2DL+1.6SL+LL
D7	Yes		1.2DL+0.2SL
D8	Yes		1.2DL+EQ
D9	Yes		1.2DL+LL+0.2SL
D10	Yes		1.2DL+EQ+0.2SL
D11	Yes		1.2DL+EQ+LL
D12	Yes		1.2DL+EQ+LL+0.2SL

D13 Yes 0.9DL+EQ

Concentrated loads:

Story	Condition	Direction	Magnitude [Kip]	Eccentricity [in]	Distance [ft]
2	DL	Vertical	2.00	0.00	1.17
1	DL	Vertical	2.67	0.00	1.17
2	SL	Vertical	35.85	0.00	1.17
1	LL	Vertical	5.33	0.00	1.17
2	EQ	Horizontal	7.10	0.00	0.00
1	EQ	Horizontal	1.20	0.00	0.00

Distributed loads:

Consider self weight : DL

BEARING WALL DESIGN:

Status : OK



Geometry:

Segment	X Coordinate [ft]	Y Coordinate [ft]	Width [ft]	Height [ft]
1	0.00	0.00	2.33	10.50
2	0.00	10.50	2.33	14.50
3	0.00	25.00	2.33	3.00

Vertical reinforcement:

Reinforcement layers : 2

Segment	Bars	Spacing [in]	Ld [in]
1	5-#6	6.00	28.46
2	5-#6	6.00	28.46
3	5-#6	6.00	28.46

Intermediate results for axial-bending

Segment	Condition	c [in]	d [in]
1	DC1 (Top)	1.81	6.25
2	DC1 (Top)	1.75	6.25
3	DC1 (Top)	1.73	6.25

Combined axial flexure

Segment	Condition	Pu [Kip]	Mu [Kip*ft]	ϕ^*Mn [Kip*ft]	Mu/ ϕ^*Mn	
1	DC1 (Top)	12.08	0.00	57.58	0.00	
2	DC1 (Top)	3.67	0.00	55.90	0.00	
3	DC1 (Top)	0.10	0.00	55.19	0.00	

Interaction diagrams, P vs. M:

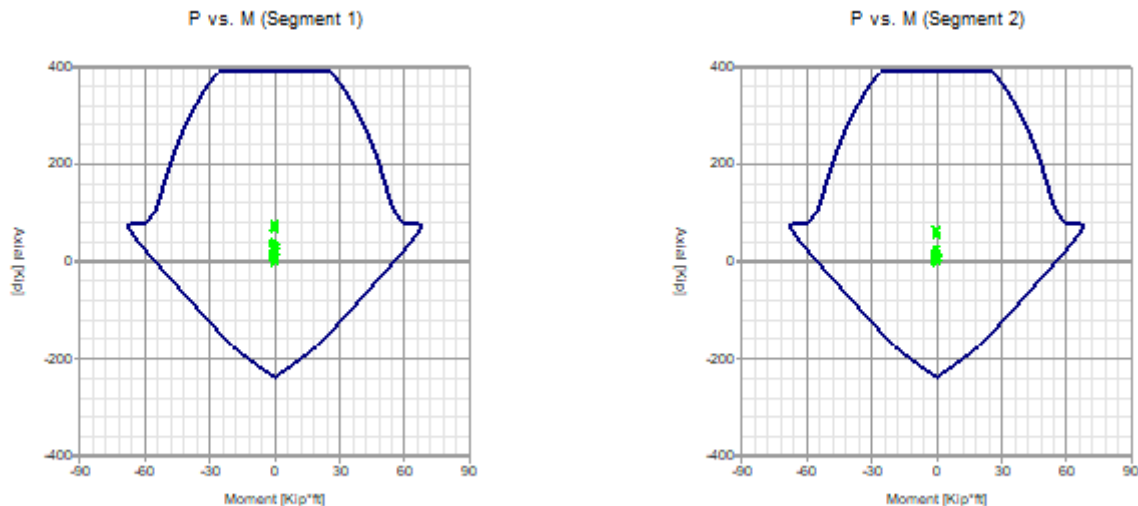

Axial compression

Segment	Condition	Pu [Kip]	ϕ^*Pn [Kip]	Pu/ ϕ^*Pn	
1	D6 (Bottom)	75.87	388.25	0.20	
2	D6 (Bottom)	65.26	388.25	0.17	
3	D5 (Bottom)	5.45	388.25	0.01	

Axial tension

Segment	Condition	Pu [Kip]	ϕ^*P_n [Kip]	P_u/ϕ^*P_n	
1	DC1 (Top)	0.00	237.60	0.00	<input type="text"/>
2	DC1 (Top)	0.00	237.60	0.00	<input type="text"/>
3	D5 (Top)	0.30	237.60	0.00	<input type="text"/>

Shear

Segment	Condition	Vu [Kip]	ϕ^*V_n [Kip]	V_u/ϕ^*V_n	
1	DC1 (Top)	0.000	16.602	0.00	<input type="text"/>
2	DC1 (Top)	0.000	16.602	0.00	<input type="text"/>
3	DC1 (Top)	0.000	16.602	0.00	<input type="text"/>

SHEAR WALL DESIGN:

Status : **Warnings in design**
 - Hoops required, Section 11.7.4.1, 18.10.6.5 (Segment 1)



Geometry:

Segment	X Coordinate [ft]	Y Coordinate [ft]	Width [ft]	Height [ft]
1	0.00	0.00	2.33	10.50
2	0.00	10.50	2.33	14.50
3	0.00	25.00	2.33	3.00

Reinforcement:

Reinforcement layers : 2

Segment	Vertical reinforcement			Horizontal reinforcement		
	Bars	Spacing [in]	Ld [in]	Bars	Spacing [in]	Ld [in]
1	5-#6	6.00	28.46	31-#5	4.00	30.83
2	5-#6	6.00	28.46	22-#5	8.00	30.83
3	5-#6	6.00	28.46	5-#5	8.00	30.83

Intermediate results for axial-bending

Segment	Condition	c [in]	d [in]
1	D13 (Bottom)	7.54	22.40
2	D13 (Bottom)	7.39	22.40
3	D13 (Bottom)	7.21	22.40

Combined axial flexure

Segment	Condition	Pu [Kip]	Mu [Kip*ft]	ϕ^*Mn [Kip*ft]	Mu/ ϕ^*Mn	
1	D13 (Bottom)	9.98	-187.25	213.69	0.88	
2	D13 (Bottom)	5.49	-100.90	210.92	0.48	
3	D13 (Bottom)	0.14	-0.57	207.61	0.00	

Interaction diagrams, P vs. M:

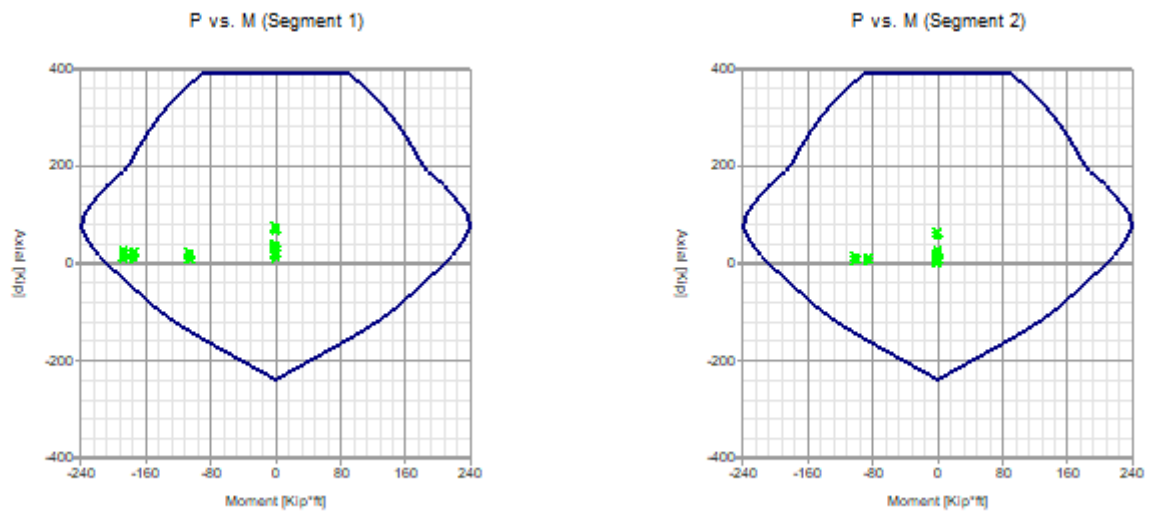

Axial compression

Segment	Condition	Pu [Kip]	ϕ^*Pn [Kip]	Pu/ ϕ^*Pn	
1	D6 (Bottom)	75.87	388.25	0.20	
2	D6 (Bottom)	65.26	388.25	0.17	
3	D6 (Bottom)	5.42	388.25	0.01	

Axial tension

Segment	Condition	Pu [Kip]	ϕ^*P_n [Kip]	P_u/ϕ^*P_n	
1	DC1 (Top)	0.00	237.60	0.00	<input type="text"/>
2	DC1 (Top)	0.00	237.60	0.00	<input type="text"/>
3	D6 (Top)	0.30	237.60	0.00	<input type="text"/>

Shear

Segment	Condition	Vu [Kip]	ϕ^*V_n [Kip]	V_u/ϕ^*V_n	
1	D13 (Max)	10.072	85.001	0.12	<input type="text"/>
2	D8 (Max)	7.869	85.001	0.09	<input type="text"/>
3	D13 (Bottom)	0.285	85.001	0.00	<input type="text"/>

Notes:

- * Pu = Axial load
- * Pn = Nominal axial load
- * Mu = Section moment
- * Mn = Maximum nominal moment
- * Vu = Design shear force
- * Vn = Nominal shear force
- * ld = Embedment length
- * As = Effective cross sectional area of reinforcement

Beam Id: Lot#80 - MB /

Date 02-09-2019

Structural Engineer:

Licensed to: FINNLAMELLI OY

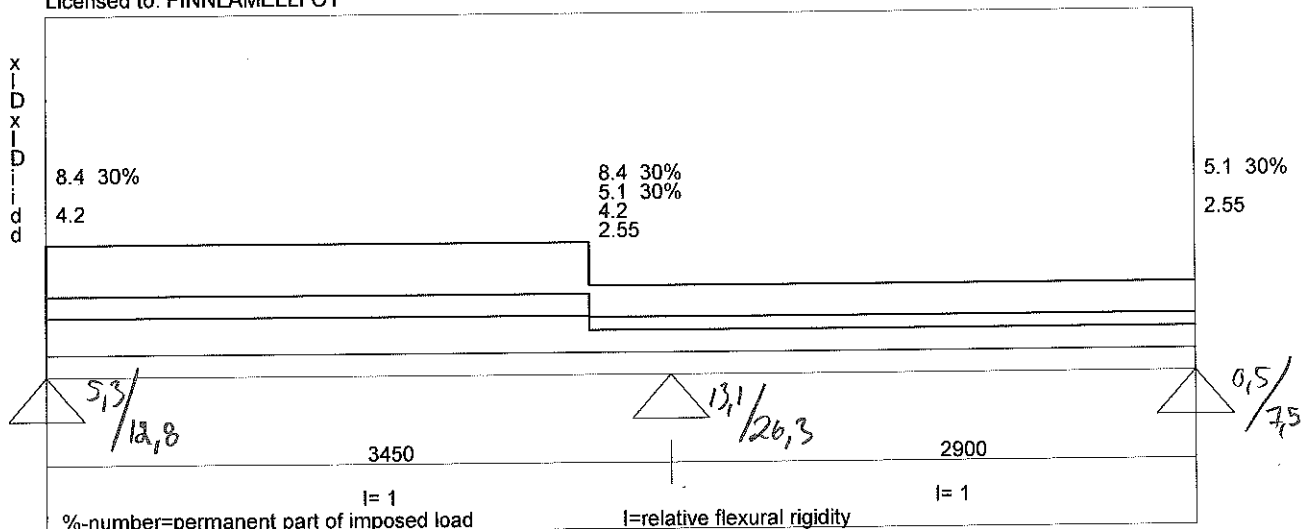

Licensed to: FINNLAMELLI OY

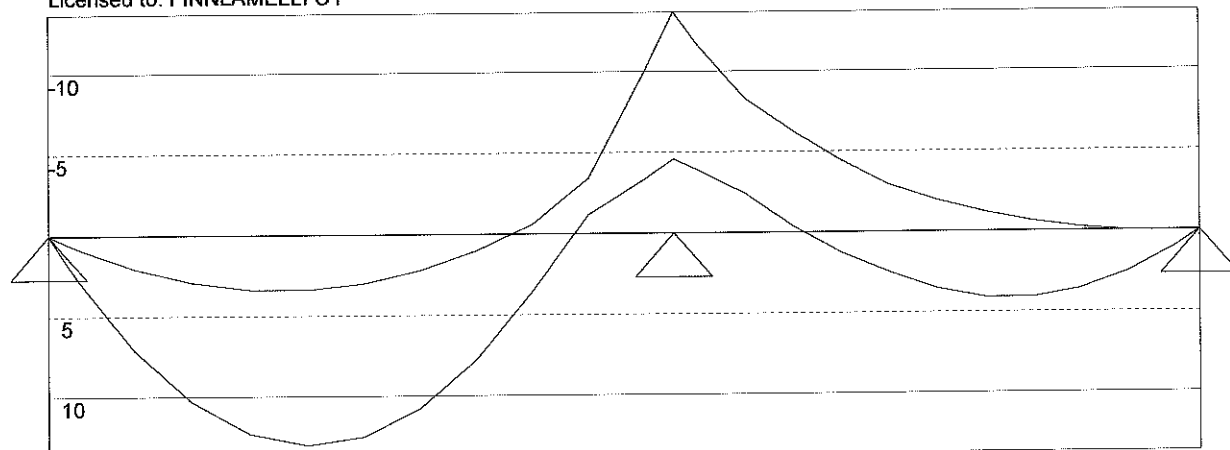

Licensed to: FINNLAMELLI OY

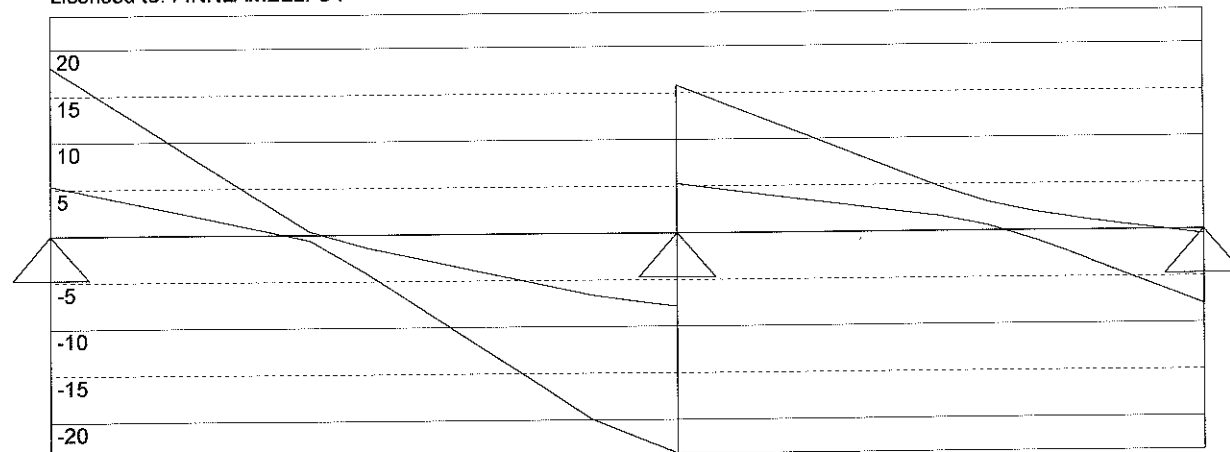

Load factor of dead load= 1 Load factor of imposed load= 1
 Load width 1 (m) (by which the loads has been multiplied during calculation)
 Max/Min reactions of beam [kN]
 18,122 39,417 7,985
 5,376 13,139 0,520

L40 140 x 260 B 2 Cf=1,00 Design method: Allowable stress design
 Increasing factor of the allowable stress 1,09
 Factored Moment/Moment capacity [kNm] 13,666 25,639 53 %
 Factored shear force/shear capacity [kN] 23,613 30,444 78 %

(1) $6L \cdot 5 \frac{1}{2} \times 10 \frac{1}{4}$

Deflection due to unfactored load (Deflection limit L/360)
 8,1 mm (84 %) 1,4 mm (17 %)

Beam Id: Lot#80 -MB2

UPD

Date 05-12-2019

Structural Engineer:

Licensed to: FINNLAMELLI OY

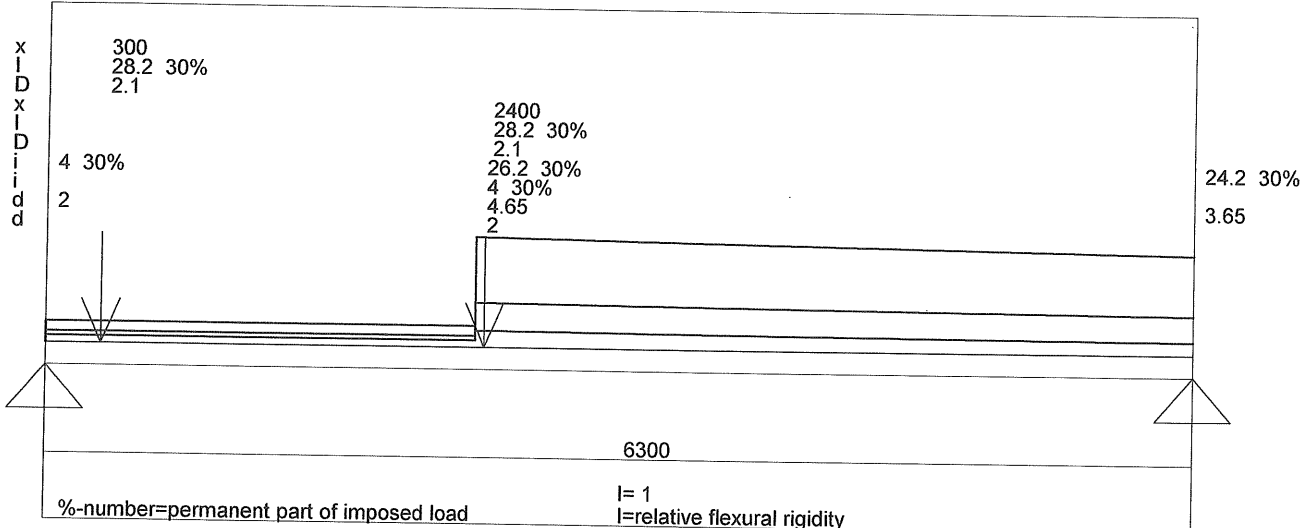

Licensed to: FINNLAMELLI OY

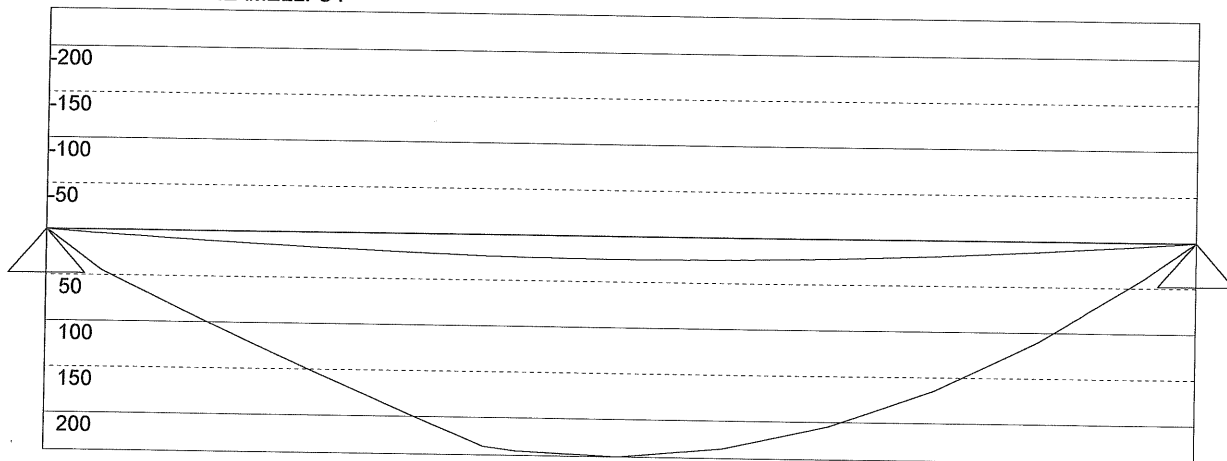

Licensed to: FINNLAMELLI OY

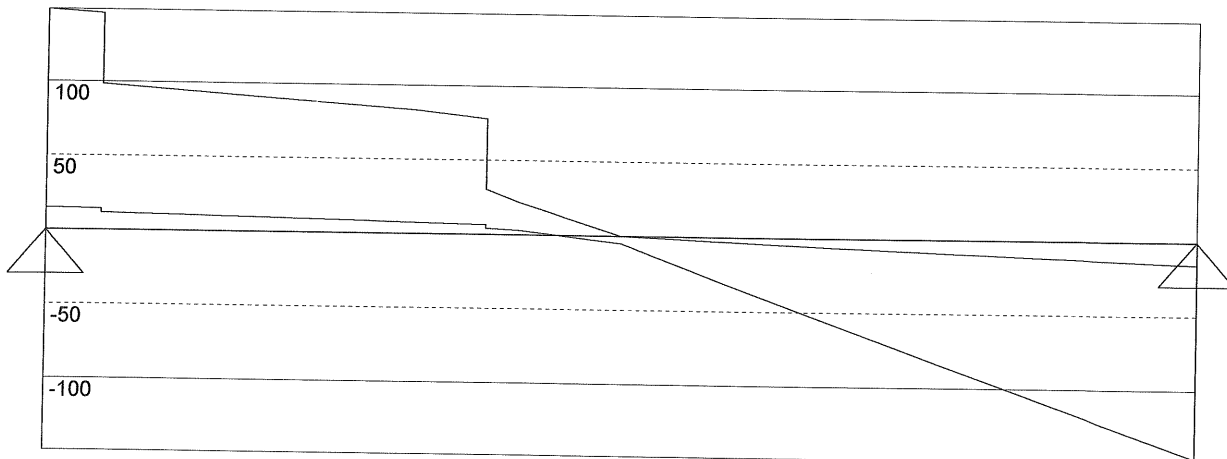

Load factor of dead load= 1.2 Load factor of imposed load= 1.6

Load width 1 (m) (by which the loads has been multiplied during calculation)

Max/Min reactions of beam [kN]

148,671 146,199
14,960 15,388

HEA 300 (Class of section=1/1) G= 88,3 I(cm4)=18263 W(cm3)=1260 fy=235

Factored Moment/Moment capacity [kNm] 240,895 325,240 74 %

Factored shear force/shear capacity [kN] 148,671 330,786 45 %

*W/O * 77*

Deflection due to unfactored load (Deflection limit L/360)

16,5 mm (94 %)

Attention! Ultimate limit design! Remember the load factors!!

Beam Id: Lot#80 - MB

Date 02-09-2019

Structural Engineer:

Licensed to: FINNLAMELLI OY

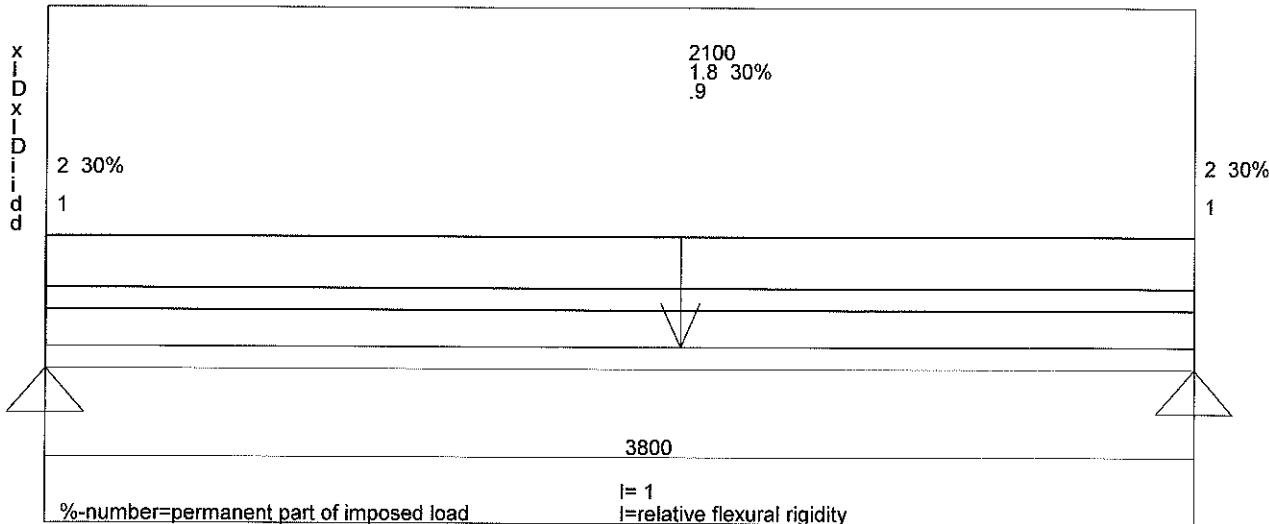

Licensed to: FINNLAMELLI OY

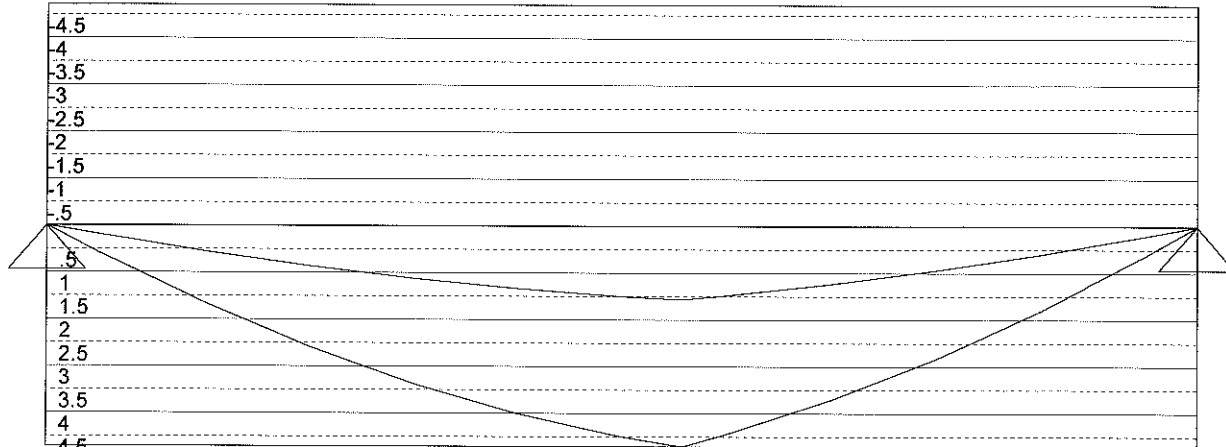

Licensed to: FINNLAMELLI OY

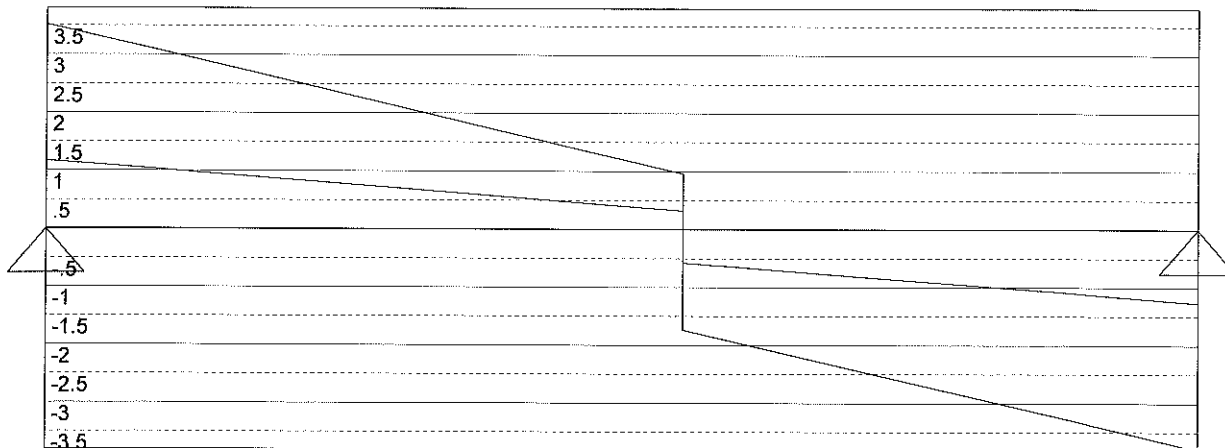

Load factor of dead load= 1 Load factor of imposed load= 1

Load width .406 (m) (by which the loads has been multiplied during calculation)

Max/Min reactions of beam [kN]

3,522 3,806
1,174 1,269

KER 38 x 300 B 2 Cf=1,00 Design method: Allowable stress design

Increasing factor of the allowable stress 1,09

Factored Moment/Moment capacity [kNm] 4,710 11,193 42 %

Factored shear force/shear capacity [kN] 3,806 14,095 27 %

(1) LVL 1 1/2" x 11 7/8"

Deflection due to unfactored load (Deflection limit L/360)

7,1 mm (68 %)

Beam Id: Lot#80 - MB 4

Date 03-09-2019

Structural Engineer:

Licensed to: FINNLAMELLI OY

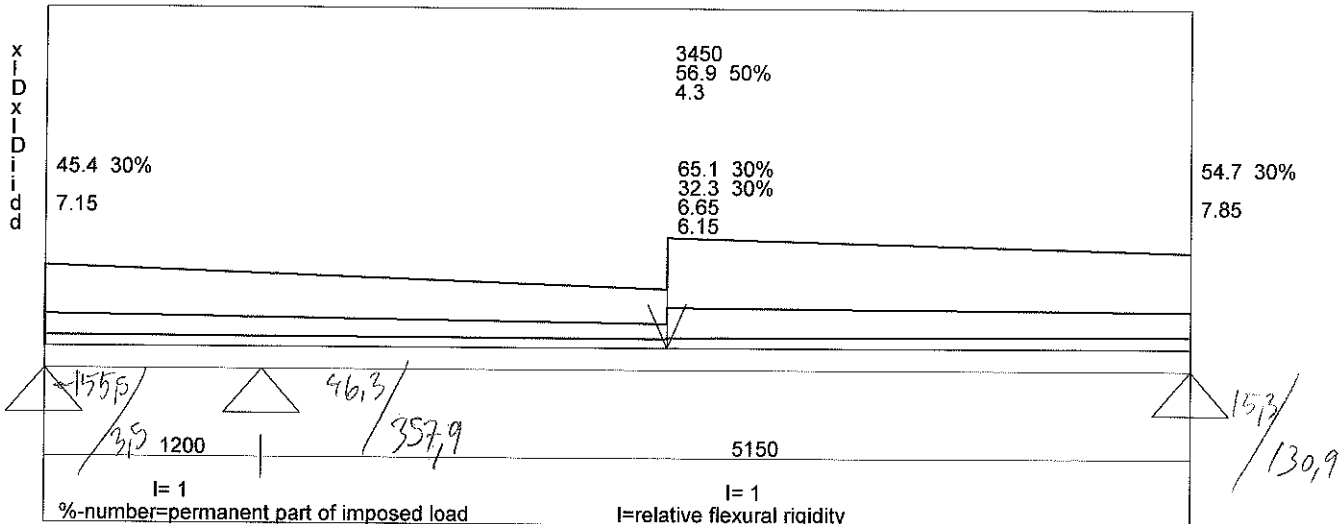

Licensed to: FINNLAMELLI OY

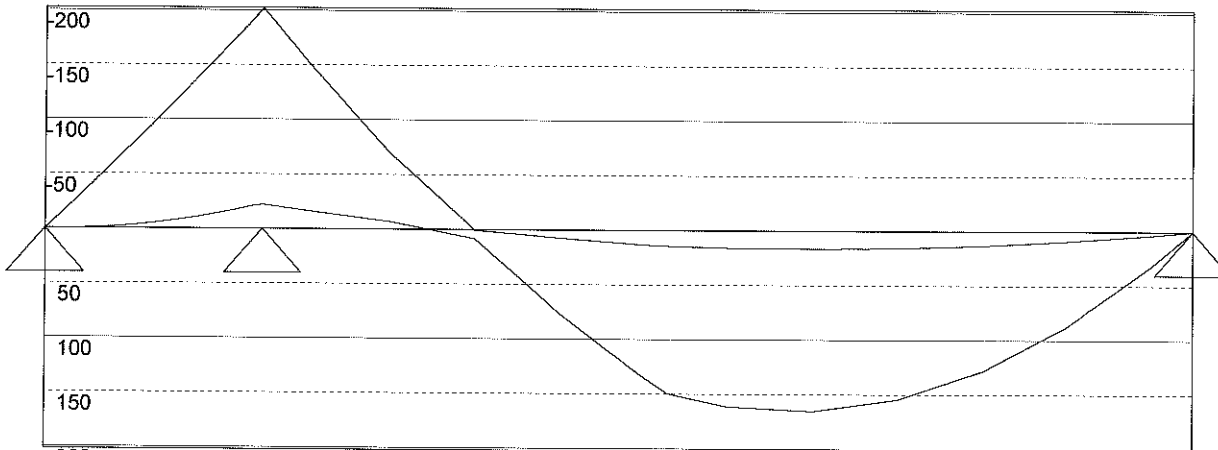

Licensed to: FINNLAMELLI OY

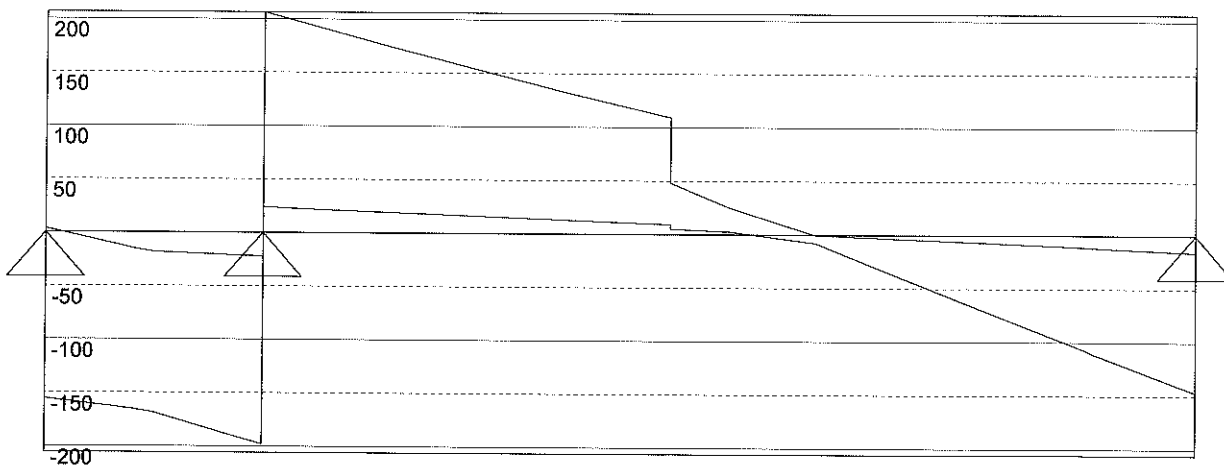

Load factor of dead load= 1 Load factor of imposed load= 1

Load width 1 (m) (by which the loads has been multiplied during calculation)

Max/Min reactions of beam [kN]

3,508 404,280 146,735
-155,518 46,307 15,817

L40 570 x 475 B 2 Cf=0,95 Design method: Allowable stress design

Increasing factor of the allowable stress 1,03

Factored Moment/Moment capacity [kNm] 202,165 311,936 65 %

Factored shear force/shear capacity [kN] 206,227 213,363 97 %

(3) GL $7 \frac{1}{2} \times 18 \frac{3}{4}$

Deflection due to unfactored load (Deflection limit L/360)

0,0 mm (1 %) 8,5 mm (59 %)

Beam Id: Lot#80 - MB 11

Date 05-09-2019

Structural Engineer:

Licensed to: FINNLAMELLI OY

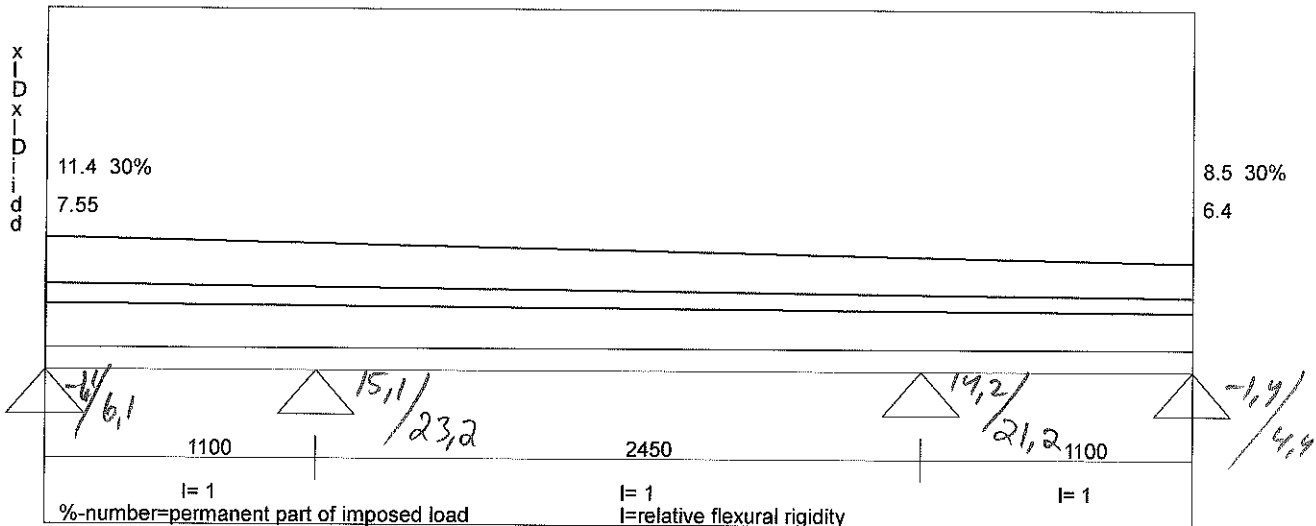

Licensed to: FINNLAMELLI OY

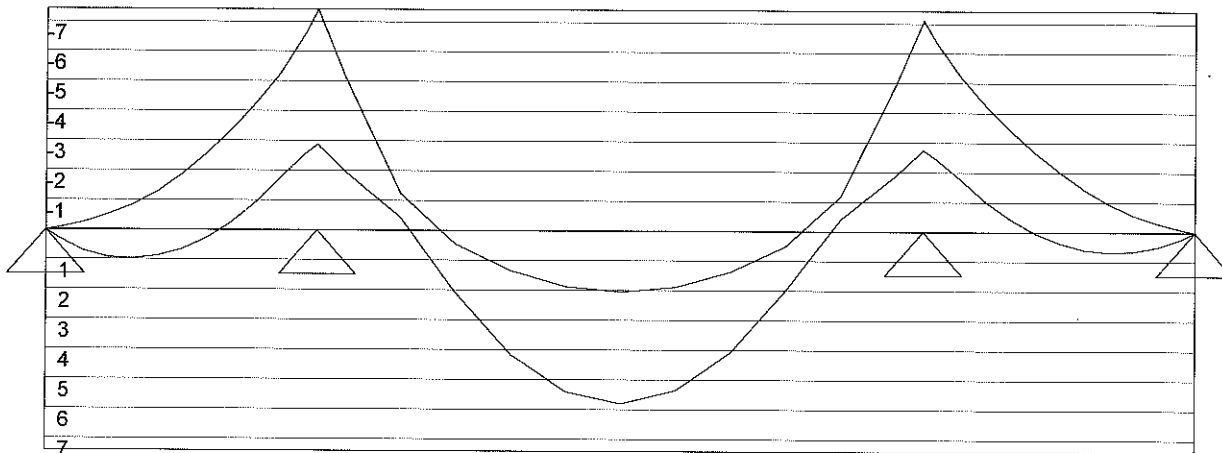

Licensed to: FINNLAMELLI OY

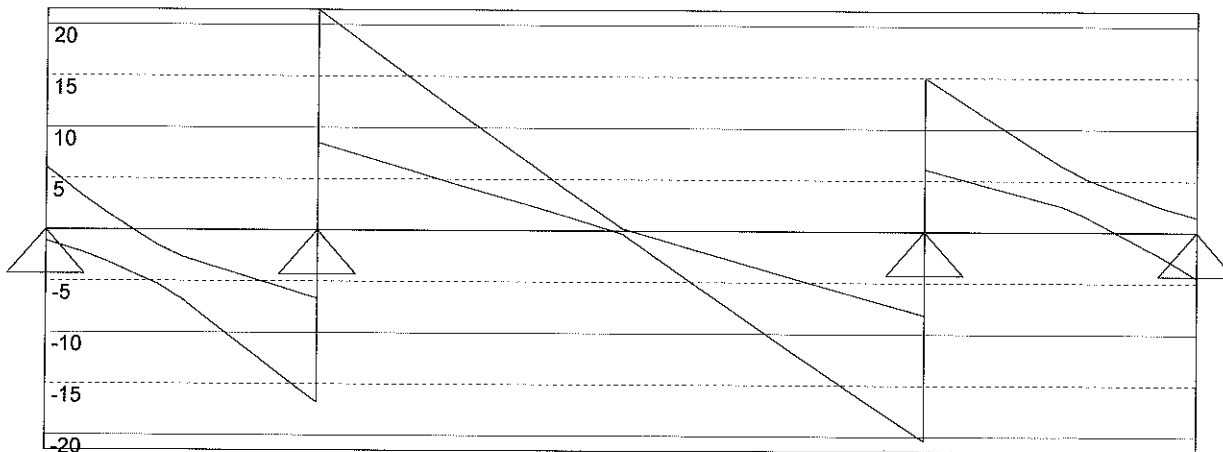

Load factor of dead load= 1 Load factor of imposed load= 1

Load width 1 (m) (by which the loads has been multiplied during calculation)

Max/Min reactions of beam [kN]

6,082 38,291 35,392 4,458

-1,087 15,186 14,273 -1,480

KER 76 x 240 B 2 Cf=1,00 Design method: Allowable stress design

Increasing factor of the allowable stress 1,11

Factored Moment/Moment capacity [kNm] 7,412 14,627 51 %

Factored shear force/shear capacity [kN] 21,482 23,024 93 %

LVL (2) 1 1/2 x 9 1/2

Deflection due to unfactored load (Deflection limit L/360)

0,0 mm (1 %) 3,1 mm (45 %) 0,0 mm (0 %)

Beam Id: Lot#80 - MB // W

Date 05-09-2019

Structural Engineer:

Licensed to: FINNLAMELLI OY

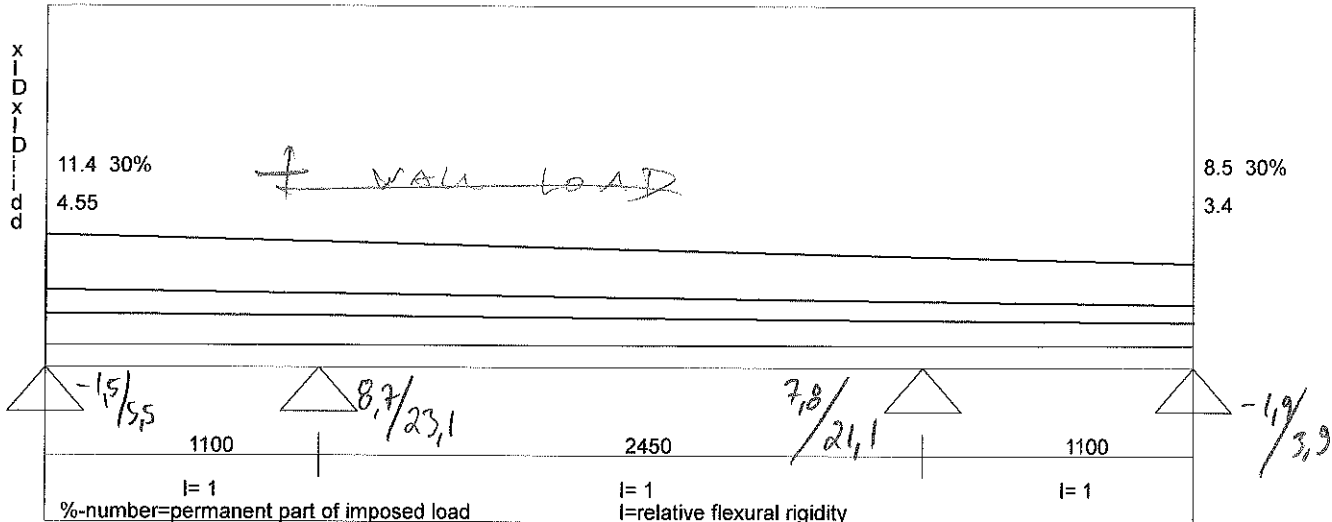

Licensed to: FINNLAMELLI OY

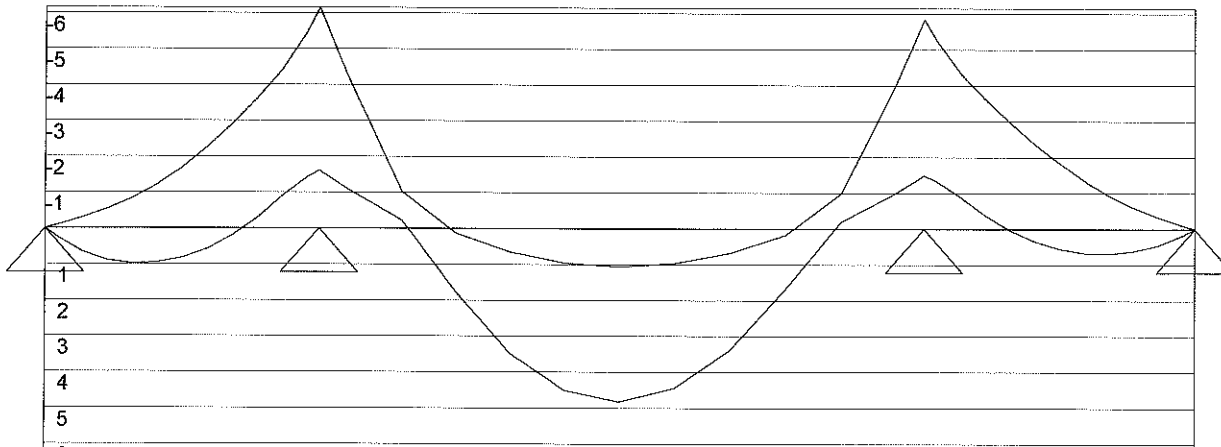

Licensed to: FINNLAMELLI OY

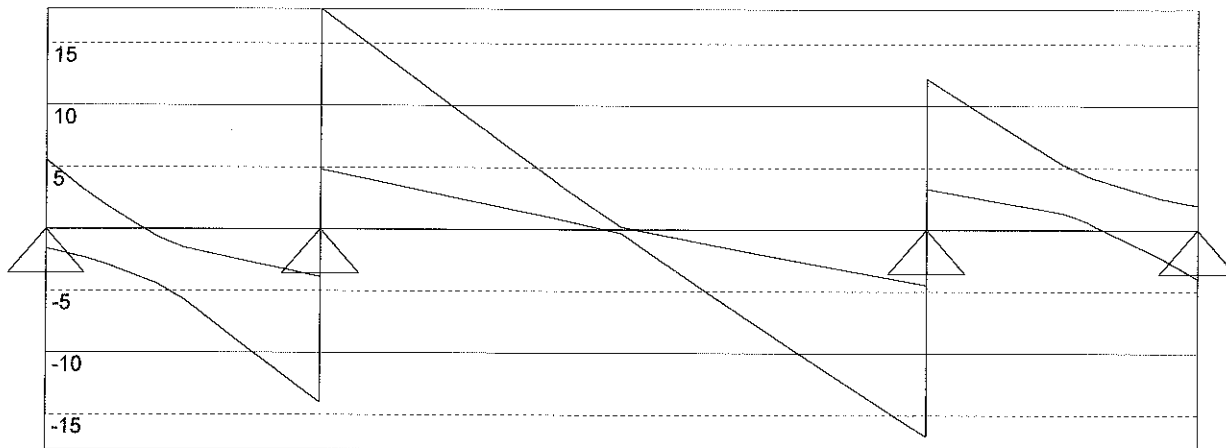

Load factor of dead load= 1 Load factor of imposed load= 1
 Load width 1 (m) (by which the loads has been multiplied during calculation)
 Max/Min reactions of beam [kN]
 5,582 31,818 28,918 3,957
 -1,587 8,713 7,800 -1,981

KER 76 x 240 B 2 Cf=1,00 Design method: Allowable stress design
 Increasing factor of the allowable stress 1,08
 Factored Moment/Moment capacity [kNm] 6,148 14,142 43 %
 Factored shear force/shear capacity [kN] 17,808 22,260 80 %

LVL (2) $1\frac{1}{2} \times 9\frac{1}{2}$

Deflection due to unfactored load (Deflection limit L/360)
 0,1 mm (3 %) 2,6 mm (38 %) 0,1 mm (2 %)

Beam Id: Lot#80 - MB 12

Date 05-09-2019

Structural Engineer:

Licensed to: FINNLAMELLI OY

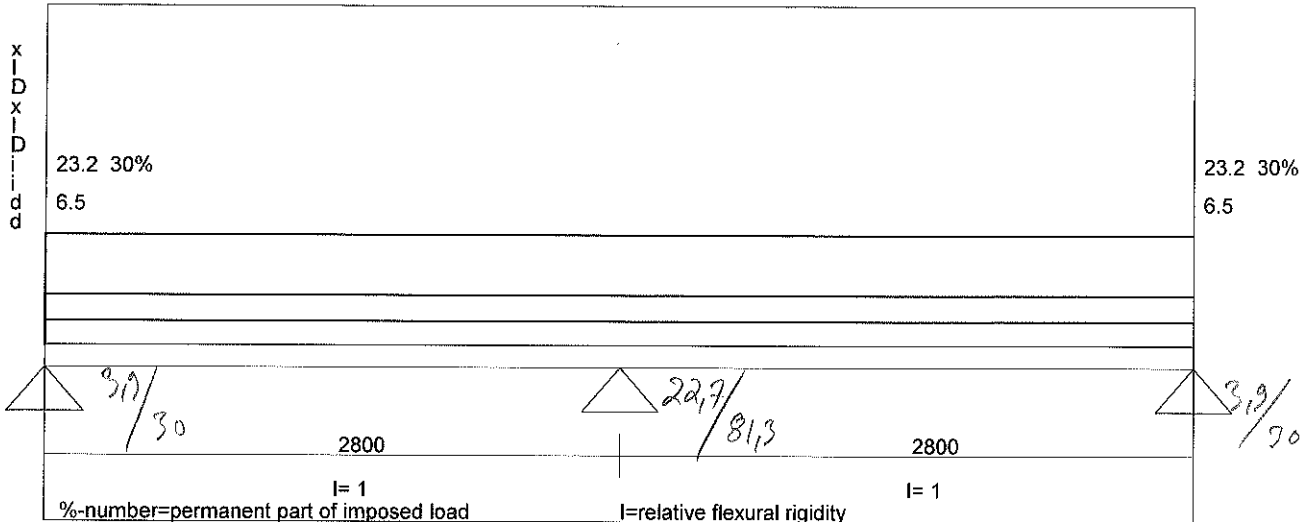

Licensed to: FINNLAMELLI OY

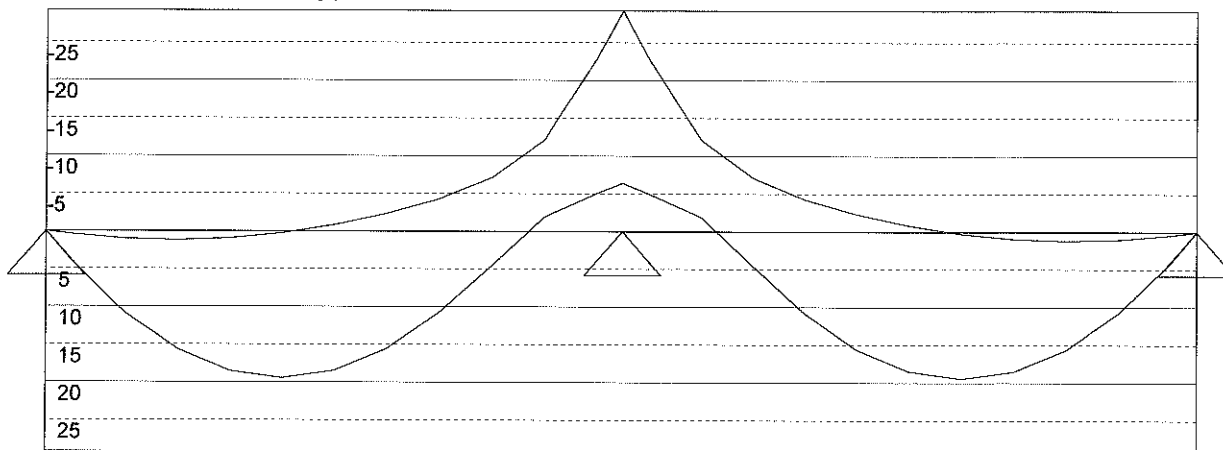

Licensed to: FINNLAMELLI OY

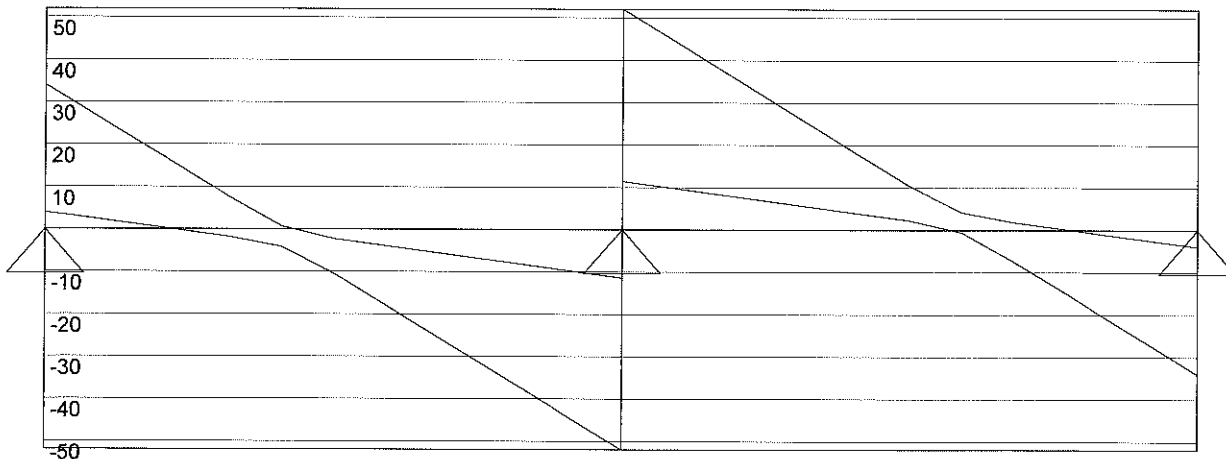

Load factor of dead load= 1 Load factor of imposed load= 1
 Load width 1 (m) (by which the loads has been multiplied during calculation)
 Max/Min reactions of beam [kN]
 33,990 104,013 33,998
 3,961 22,764 3,963

KER 132 x 355 B 2 Cf=0,98 Design method: Allowable stress design
 Increasing factor of the allowable stress 1,06
 Factored Moment/Moment capacity [kNm] 29,203 51,816 56 %
 Factored shear force/shear capacity [kN] 52,007 56,182 93 %

$v_L (3) \frac{3}{4} \times 14$

Deflection due to unfactored load (Deflection limit L/360)
 2,6 mm (34 %) 2,6 mm (34 %)

Beam Id: Lot#80 - MB 13

Date 05-09-2019

Structural Engineer:

Licensed to: FINNLAMELLI OY

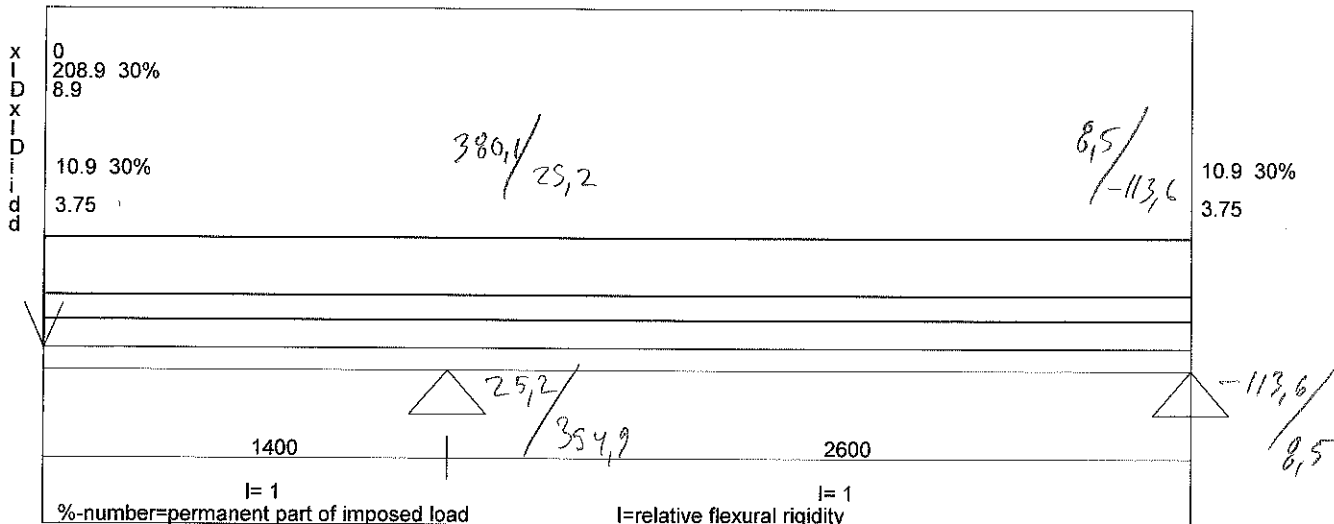

Licensed to: FINNLAMELLI OY

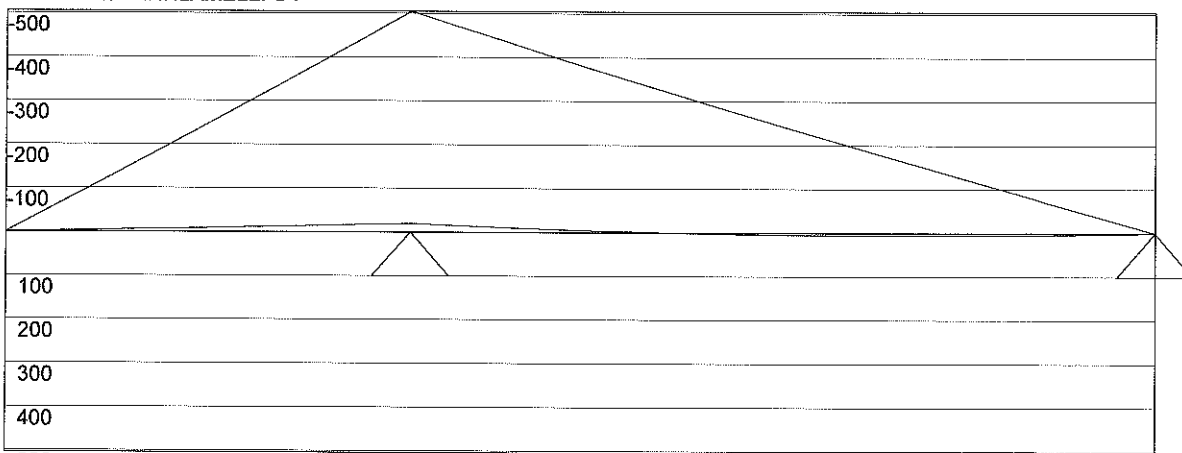

Licensed to: FINNLAMELLI OY

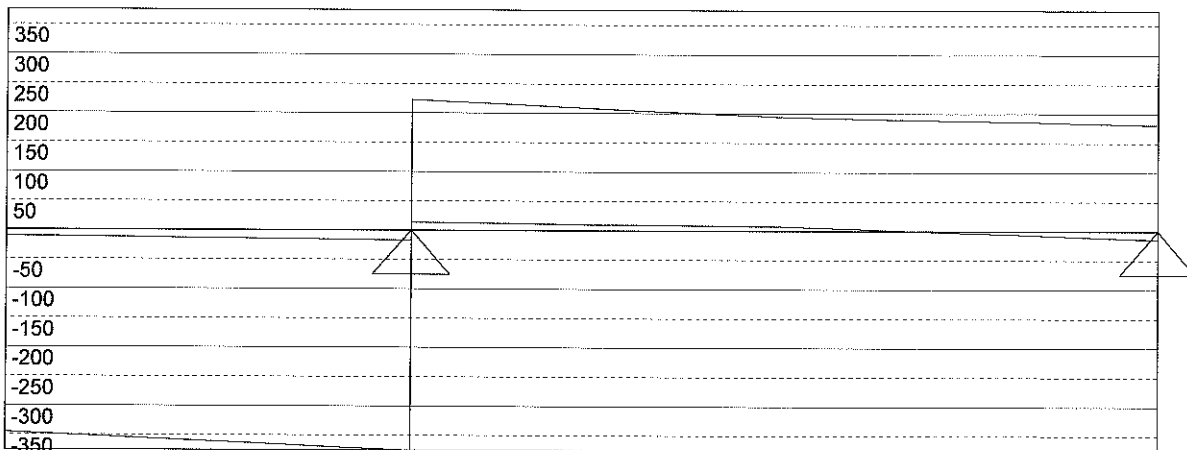

Load factor of dead load= 1.2 Load factor of imposed load= 1.6

Load width 1 (m) (by which the loads has been multiplied during calculation)

Max/Min reactions of beam [kN]

598,131 14,274
30,274 -181,333

HEB 340 (Class of section=1/1) G= 134 I(cm4)=36656 W(cm3)=2160 fy=235

Factored Moment/Moment capacity [kNm] 504,308 564,000 89 %

Factored shear force/shear capacity [kN] 375,630 538,902 70 %

w / 2 x 106

Sum inf M+S 0,91 (must be <=1) x= 1399 M=504,31 S=375,63

Deflection due to unfactored load (Deflection limit L/360)/L/180!

7,6 mm (98 %) 0,0 mm (0 %)

Attention! Ultimate limit design! Remember the load factors!!

Beam Id: Lot#80 - MB 14

Date 05-09-2019

Structural Engineer:

Licensed to: FINNLAMELLI OY

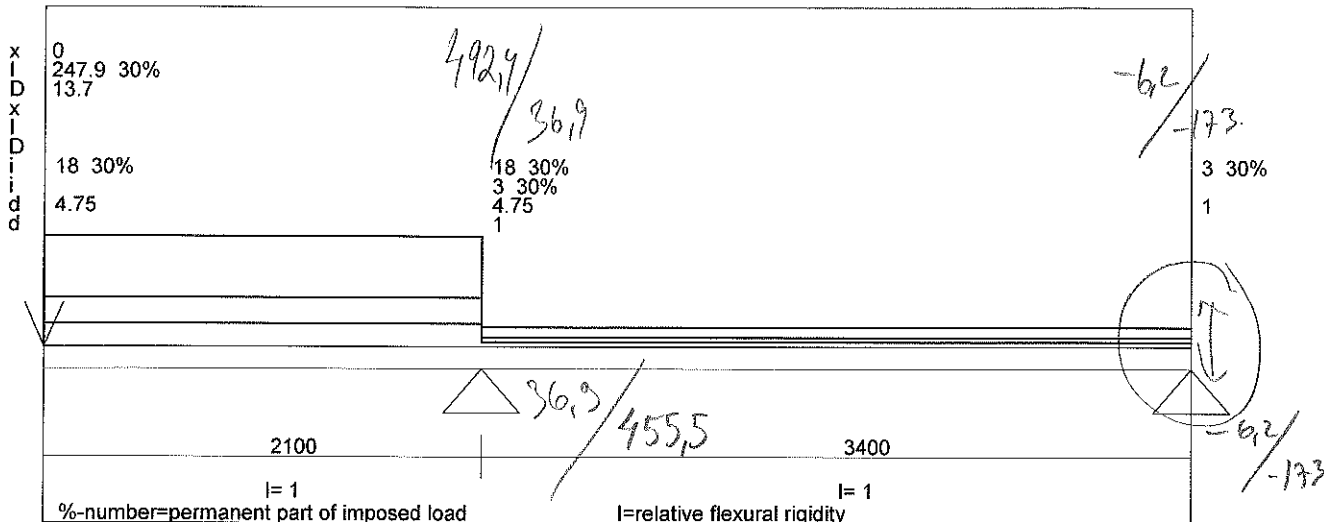

Licensed to: FINNLAMELLI OY

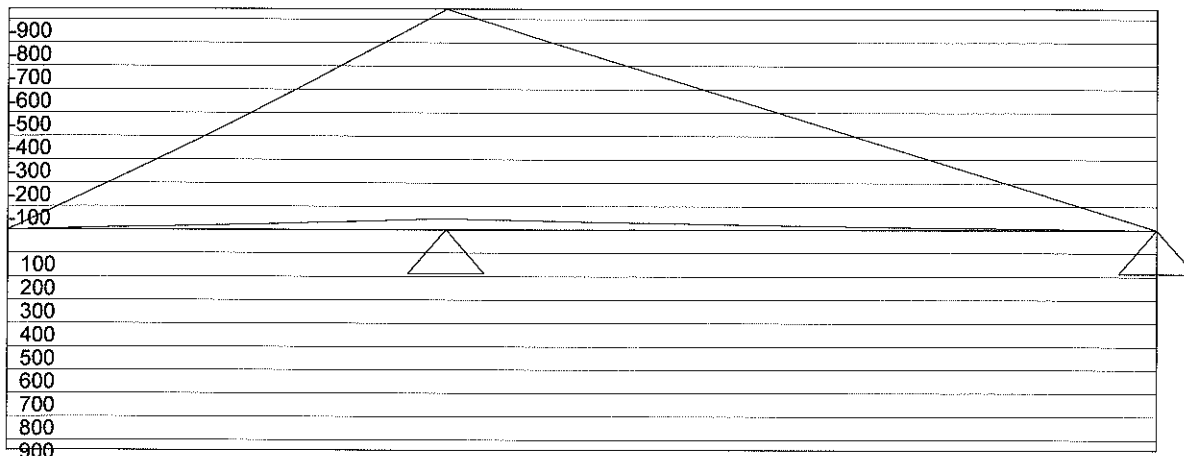

Licensed to: FINNLAMELLI OY

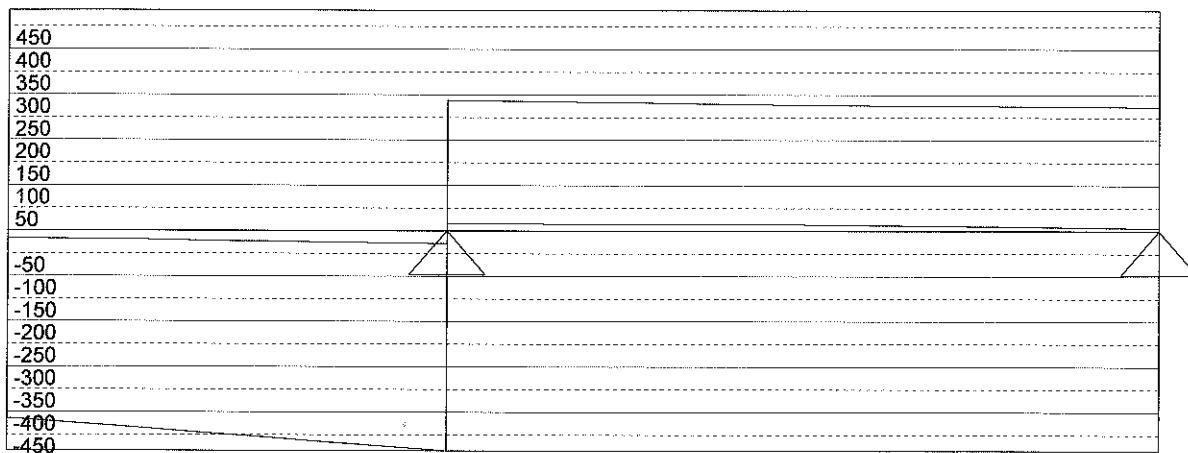

Load factor of dead load= 1.2 Load factor of imposed load= 1.6

Load width 1 (m) (by which the loads has been multiplied during calculation)

Max/Min reactions of beam [kN]

773,208 -6,097
44,297 -273,007

HEB 500 (Class of section=1/1) G= 187 I(cm4)=107176 W(cm3)=4290 fy=235

Factored Moment/Moment capacity [kNm] 943,386 1132,700 = 83 %

Factored shear force/shear capacity [kN] 485,516 965,004 50 %

Sum infl M+S 0,85 (must be <=1) x= 2099 M=943,38 S=485,52

Deflection due to unfactored load (Deflection limit L/360)/L/180)

10,1 mm (87 %) -0,1 mm (1 %)

Attention! Ultimate limit design! Remember the load factors!!

W 12 x 252 or

W 14 x 211

Beam Id: Lot#80 - MB

Date 05-09-2019

Structural Engineer: **15**

Licensed to: FINNLAMELLI OY

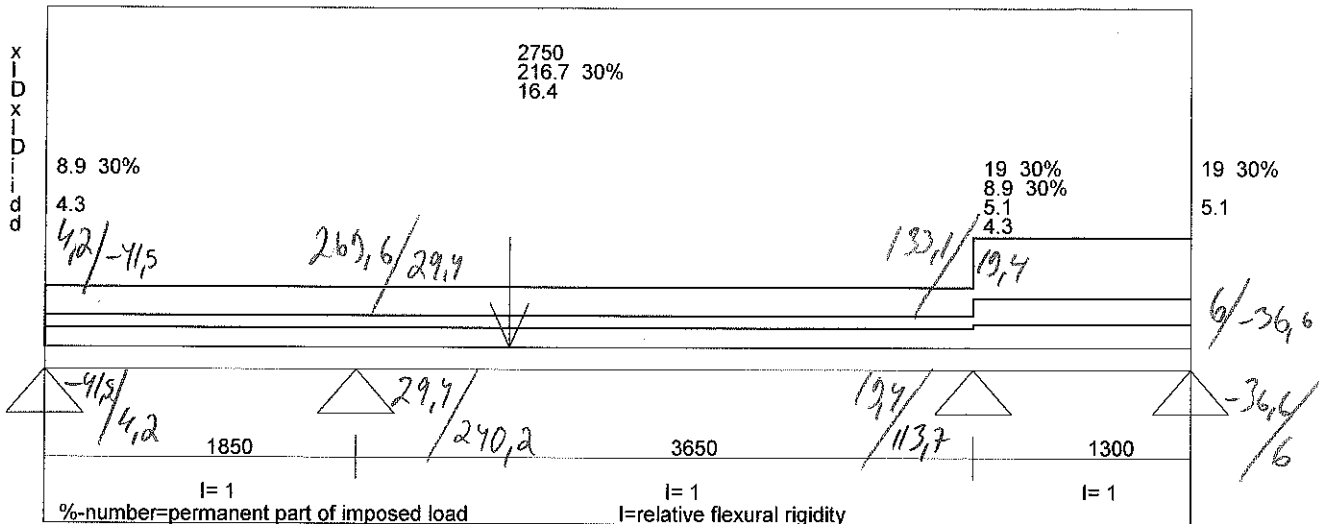

Licensed to: FINNLAMELLI OY

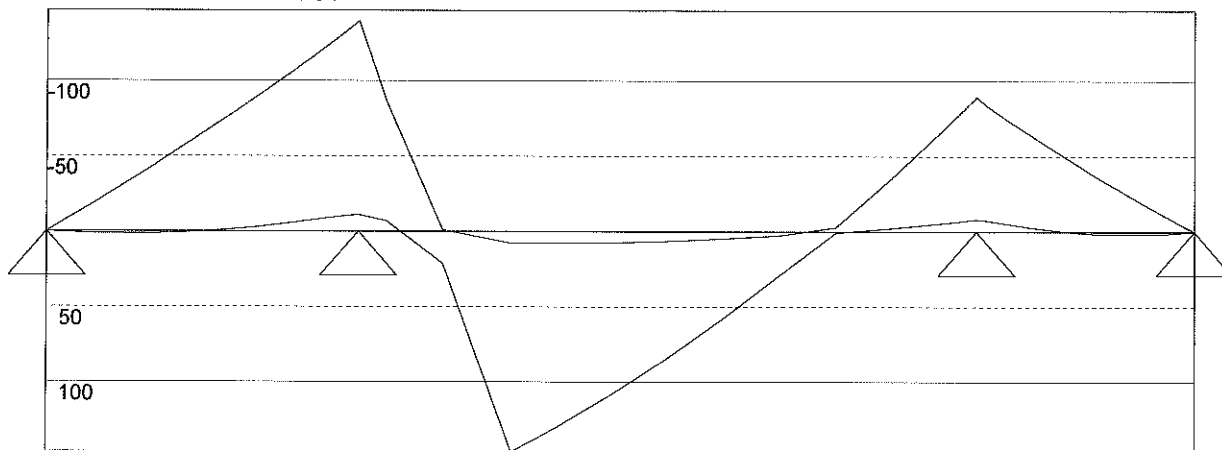

Licensed to: FINNLAMELLI OY

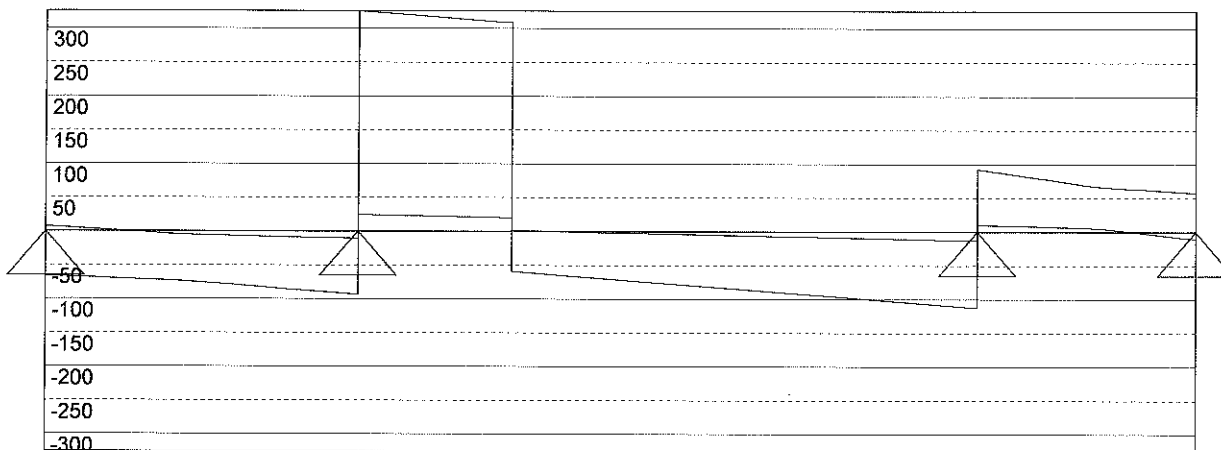

Load factor of dead load= 1.2 Load factor of imposed load= 1.6

Load width 1 (m) (by which the loads has been multiplied during calculation)

Max/Min reactions of beam [kN]

7,203 419,395 204,910 10,587
-66,004 35,168 23,068 -57,769

HEB 260 (Class of section=1/1) G= 93 I(cm4)=14919 W(cm3)=1150 fy=235

Factored Moment/Moment capacity [kNm] 146,610 301,270 49 %

Factored shear force/shear capacity [kN] 325,839 341,925 95 %

W10 x 68

Deflection due to unfactored load (Deflection limit L/360)

0,0 mm (0 %) 2,2 mm (22 %) 0,0 mm (0 %)

Attention! Ultimate limit design! Remember the load factors!!

Beam Id: Lot#80 - MB *16*

Date 05-09-2019

Structural Engineer:

Licensed to: FINNLAMELLI OY

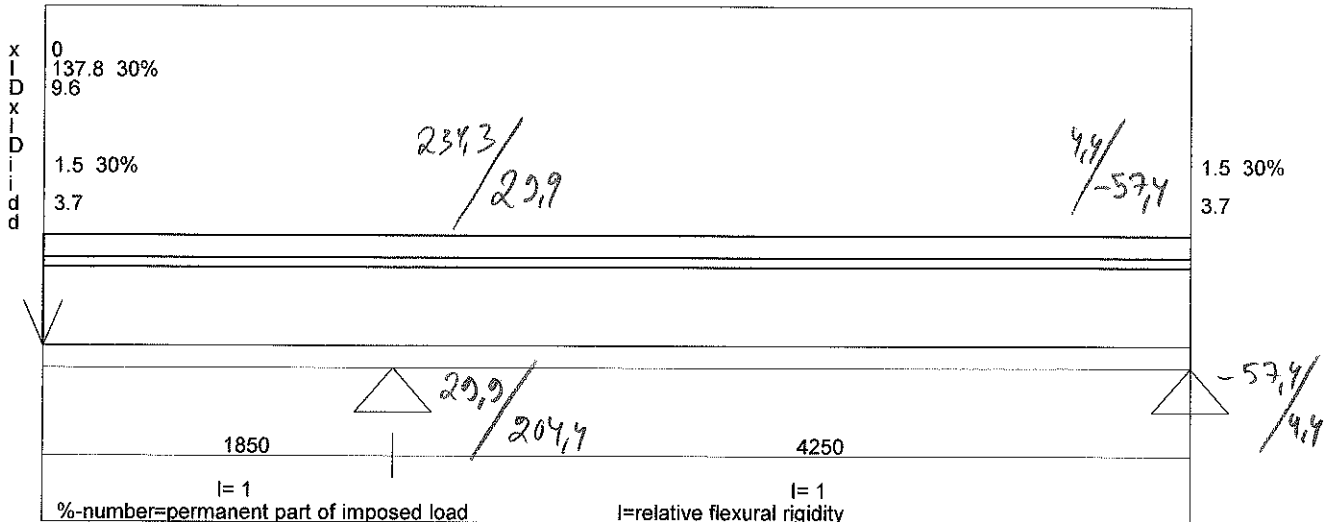

Licensed to: FINNLAMELLI OY

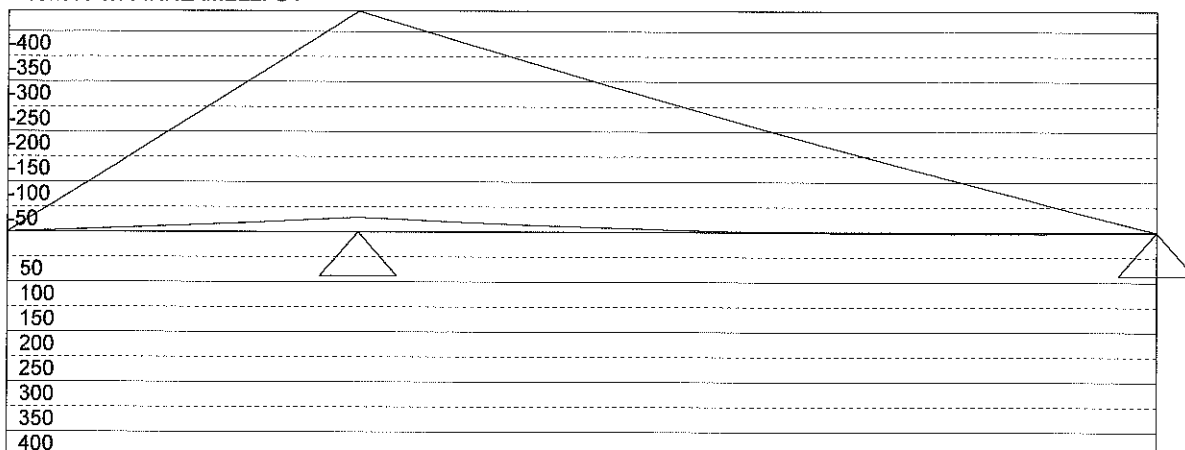

Licensed to: FINNLAMELLI OY

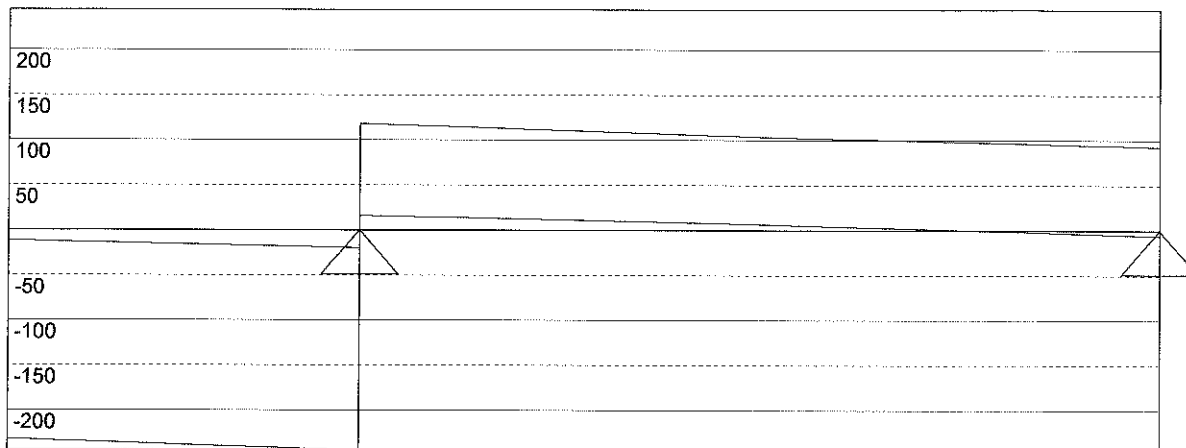

Load factor of dead load= 1.2 Load factor of imposed load= 1.6

Load width 1 (m) (by which the loads has been multiplied during calculation)

Max/Min reactions of beam [kN]

362,920 6,203
35,967 -92,772

HEB 400 (Class of section=1/1) G= 155 I(cm4)=57680 W(cm3)=2880 fy=235

Factored Moment/Moment capacity [kNm] 440,836 761,400 58 %

Factored shear force/shear capacity [kN] 244,651 715,716 34 %

Deflection due to unfactored load (Deflection limit L/360)/L/180!

8,5 mm (83 %) -0,1 mm (0 %)

Attention! Ultimate limit design! Remember the load factors!!

*W 12 x 152 on
W 14 x 132*

Beam Id: Lot#80 - MB 17

Date 09-09-2019

Structural Engineer:

Licensed to: FINNLAMELLI OY

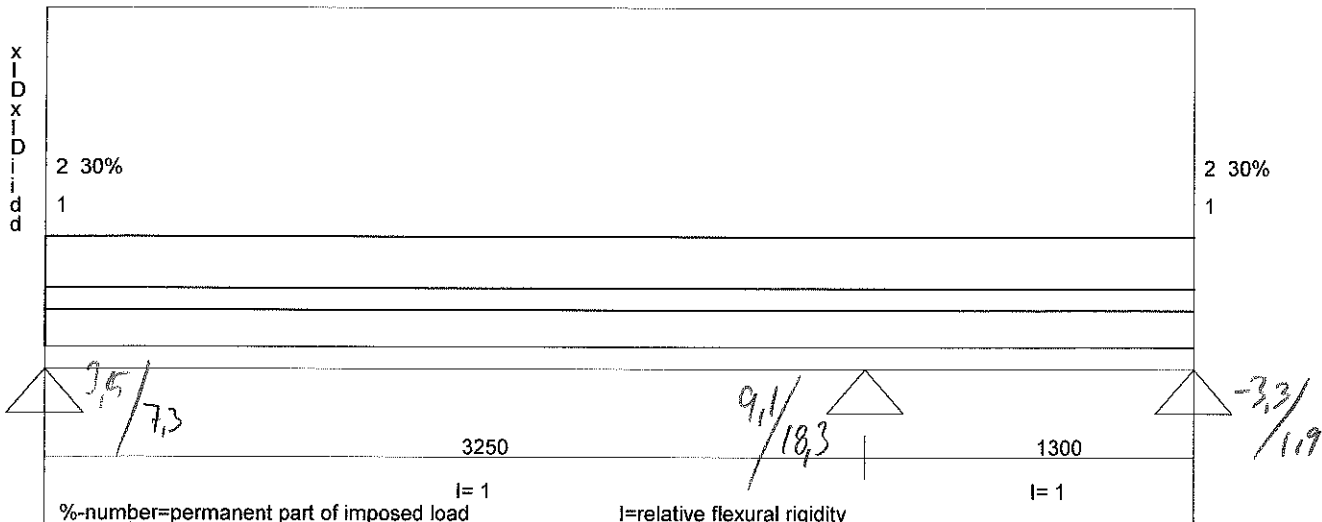

Licensed to: FINNLAMELLI OY

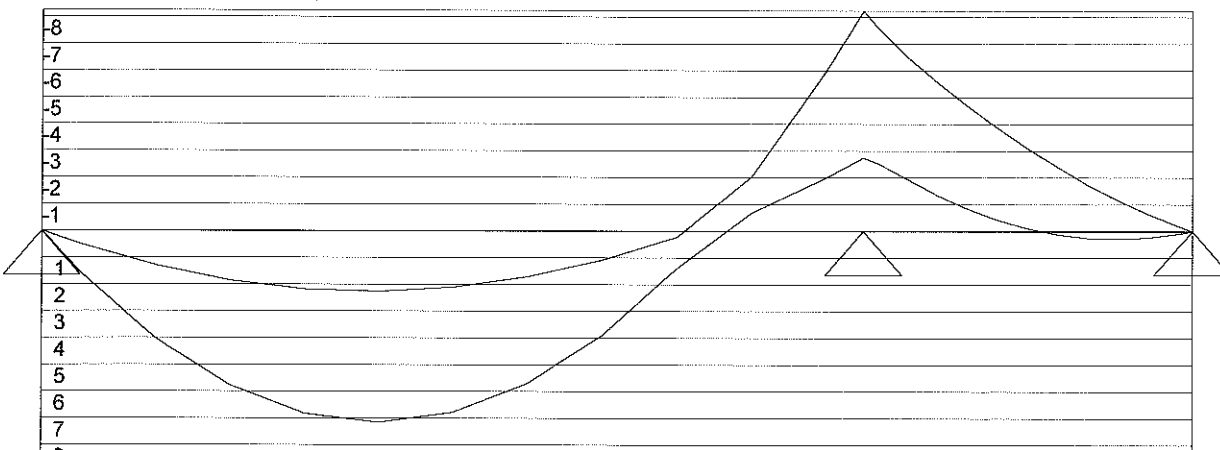

Licensed to: FINNLAMELLI OY

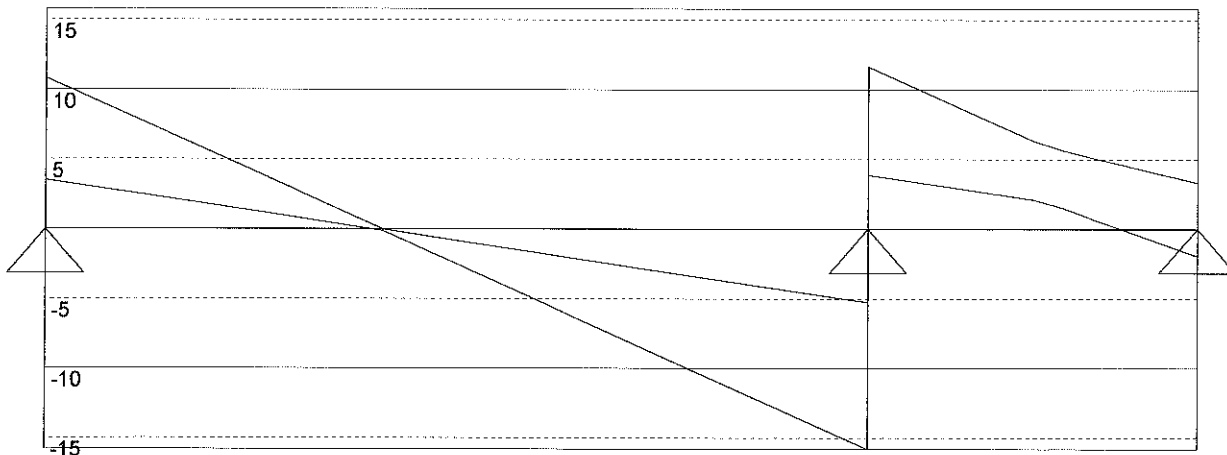

Load factor of dead load= 1 Load factor of imposed load= 1
 Load width 2.725 (m) (by which the loads
 has been multiplied during calculation)
 Max/Min reactions of beam [kN]
 10,819 27,463 1,962
 3,512 9,154 -3,323

KER 76 x 300 B 2 Cf=1,00 Design method: Allowable stress design
 Increasing factor of the allowable stress 1,09
 Factored Moment/Moment capacity [kNm] 8,233 22,385 37 %
 Factored shear force/shear capacity [kN] 15,815 28,189 56 %

LVL (2) $1\frac{1}{2} \times 11\frac{7}{8}$

Deflection due to unfactored load (Deflection limit L/360)
 3,7 mm (41 %) 0,0 mm (1 %)

Beam Id: Lot#80 - MB *18*

Date 09-09-2019

Structural Engineer:

Licensed to: FINNLAMELLI OY

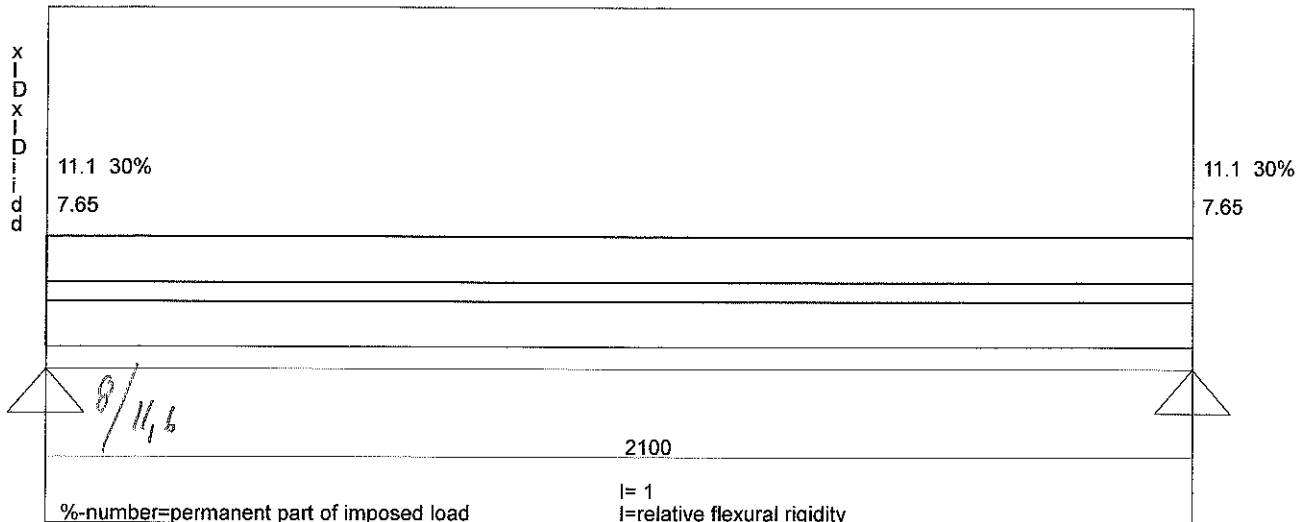

Licensed to: FINNLAMELLI OY

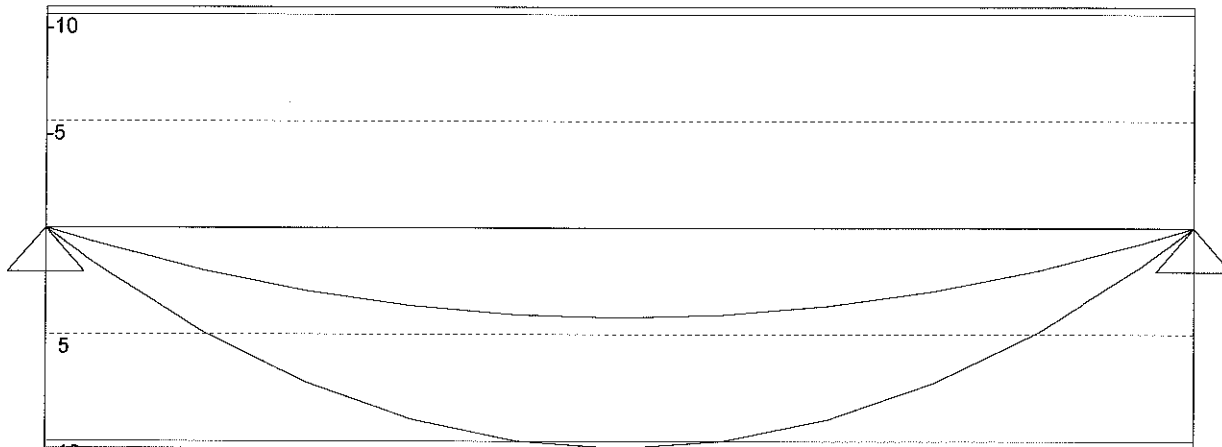

Licensed to: FINNLAMELLI OY

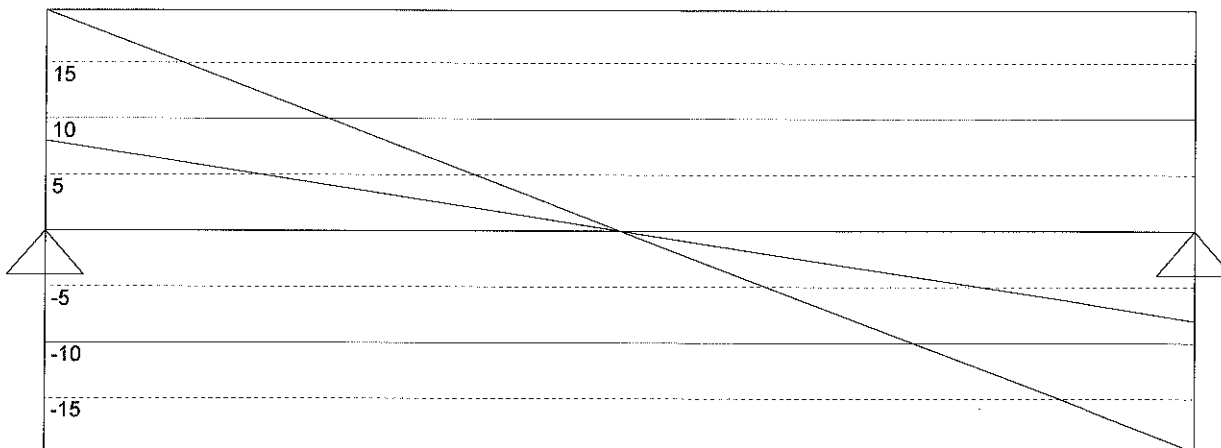

Load factor of dead load= 1 Load factor of imposed load= 1
 Load width 1 (m) (by which the loads
 has been multiplied during calculation)
 Max/Min reactions of beam [kN]
 19,684 19,688
 8,031 8,033

KER 76 x 300 B 2 Cf=1,00 Design method: Allowable stress design
 Increasing factor of the allowable stress 1,11
 Factored Moment/Moment capacity [kNm] 10,336 22,851 45 %
 Factored shear force/shear capacity [kN] 19,684 28,775 68 %

LVL (2) 1 1/2 x 11 7/8

Deflection due to unfactored load (Deflection limit L/360)
 2,7 mm (46 %)

Beam Id: Lot#80 - MB 10

Date 09-09-2019

Structural Engineer:

Licensed to: FINNLAMELLI OY

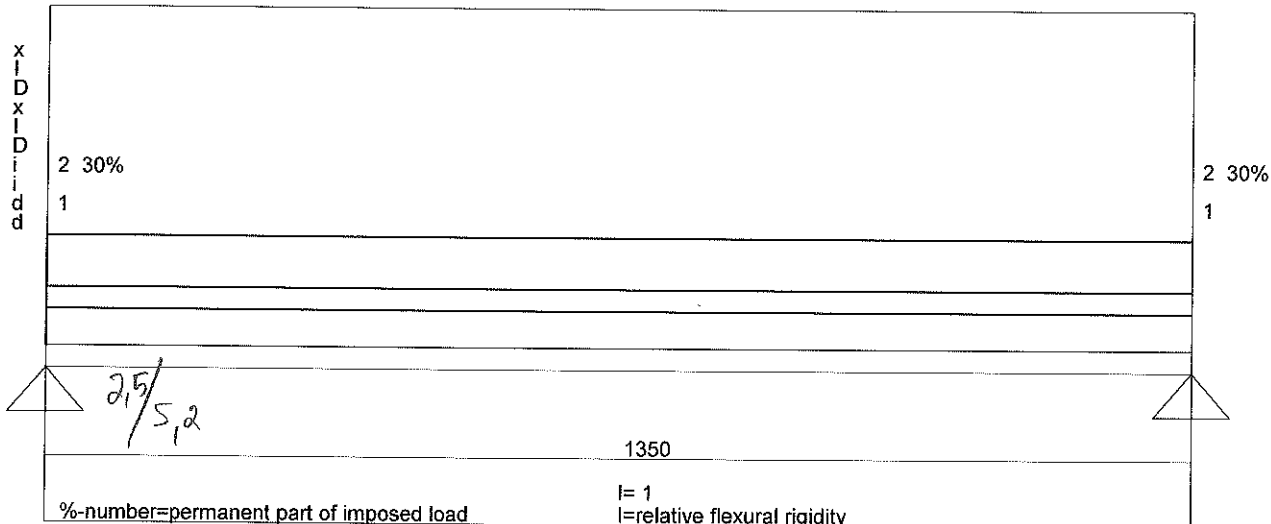

Licensed to: FINNLAMELLI OY

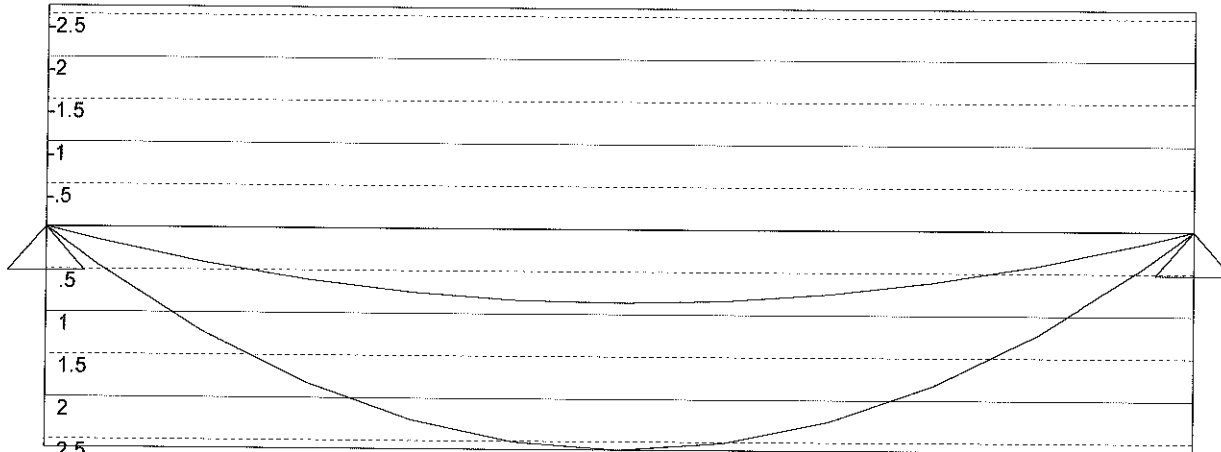

Licensed to: FINNLAMELLI OY

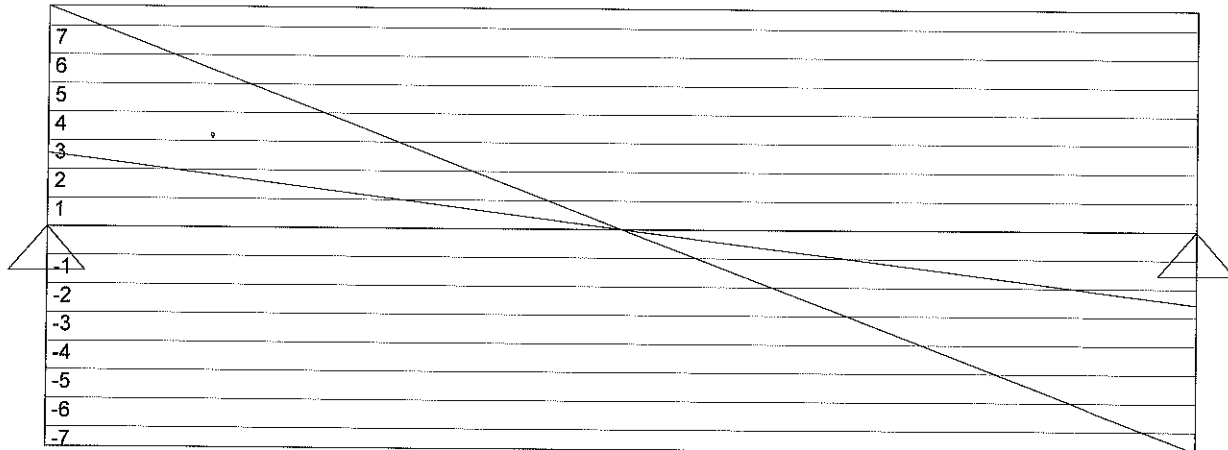

Load factor of dead load= 1 Load factor of imposed load= 1
 Load width 3.8 (m) (by which the loads has been multiplied during calculation)
 Max/Min reactions of beam [kN]
 7,693 7,695
 2,564 2,565

T24 76 x 285 B 2 Cf=1,00 Design method: Allowable stress design
 Increasing factor of the allowable stress 1,09
 Factored Moment/Moment capacity [kNm] 2,597 10,775 24 %
 Factored shear force/shear capacity [kN] 7,693 15,123 51 %

(2) 2x8

Deflection due to unfactored load (Deflection limit L/360)
 0,5 mm (14 %)

Beam Id: Lot#80 - MB ⁻²⁰

Date 09-09-2019

Structural Engineer:

Licensed to: FINNLAMELLI OY

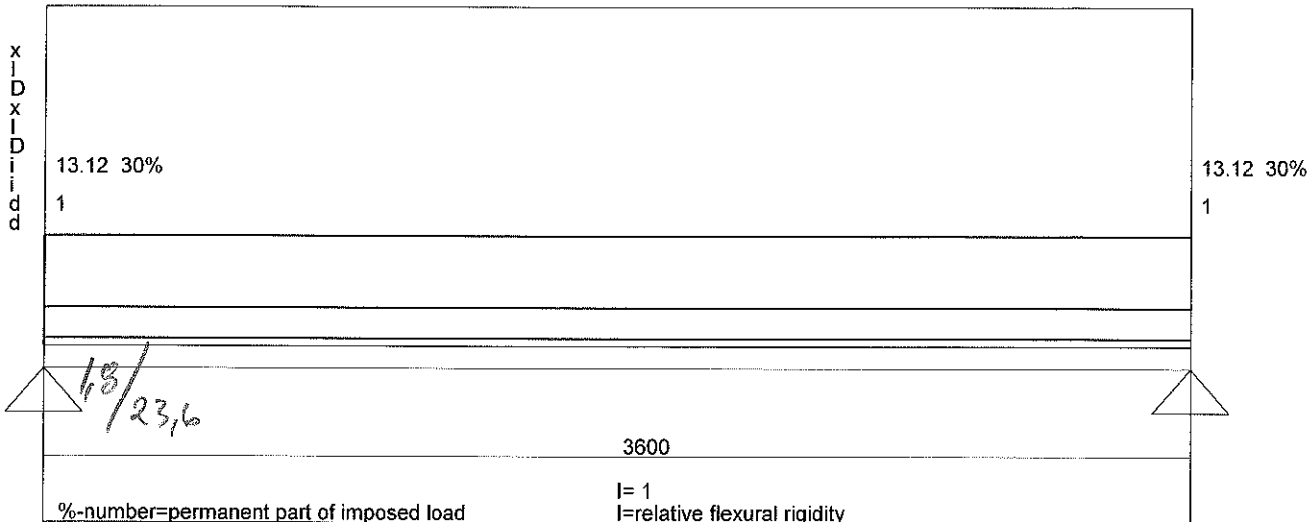

Licensed to: FINNLAMELLI OY

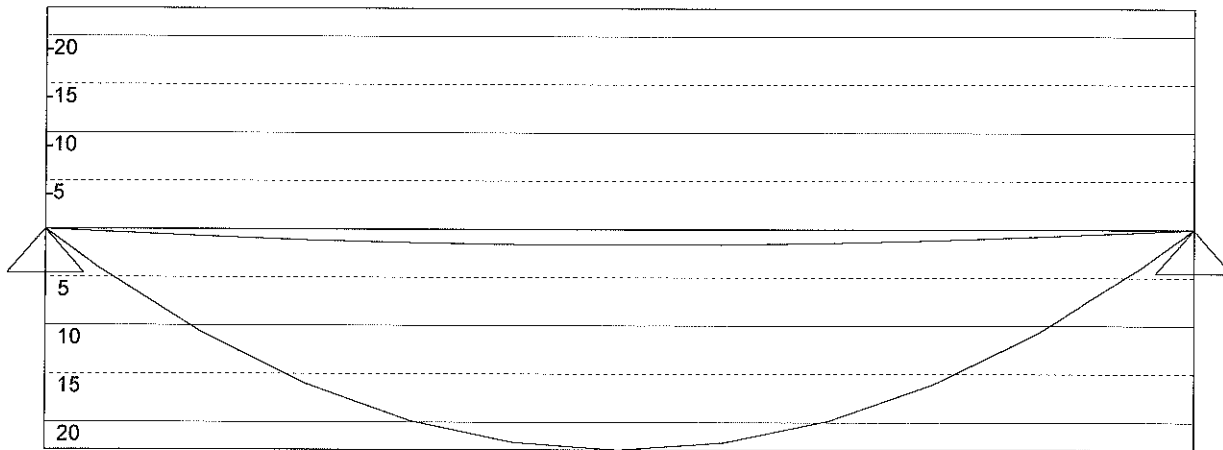

Licensed to: FINNLAMELLI OY

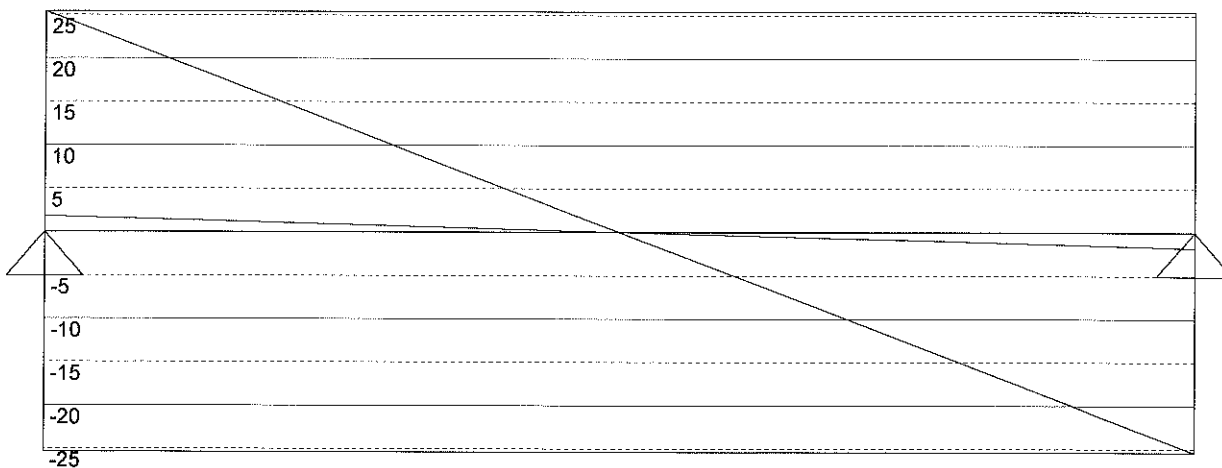

Load factor of dead load= 1 Load factor of imposed load= 1
 Load width 1 (m) (by which the loads has been multiplied during calculation)
 Max/Min reactions of beam [kN]
 25,411 25,416
 1,800 1,800

KER 88 x 355 B 2 Cf=0,98 Design method: Allowable stress design
 Increasing factor of the allowable stress 1,02
 Factored Moment/Moment capacity [kNm] 22,874 33,243 69 %
 Factored shear force/shear capacity [kN] 25,411 36,043 71 %

Handwritten note: LVL (2) $1\frac{3}{4} \times 14$

Deflection due to unfactored load (Deflection limit L/360)
 9,1 mm (91 %)

Beam Id: Lot#80 - MB 21
 Structural Engineer:

Date 09-09-2019

Licensed to: FINNLAMELLI OY

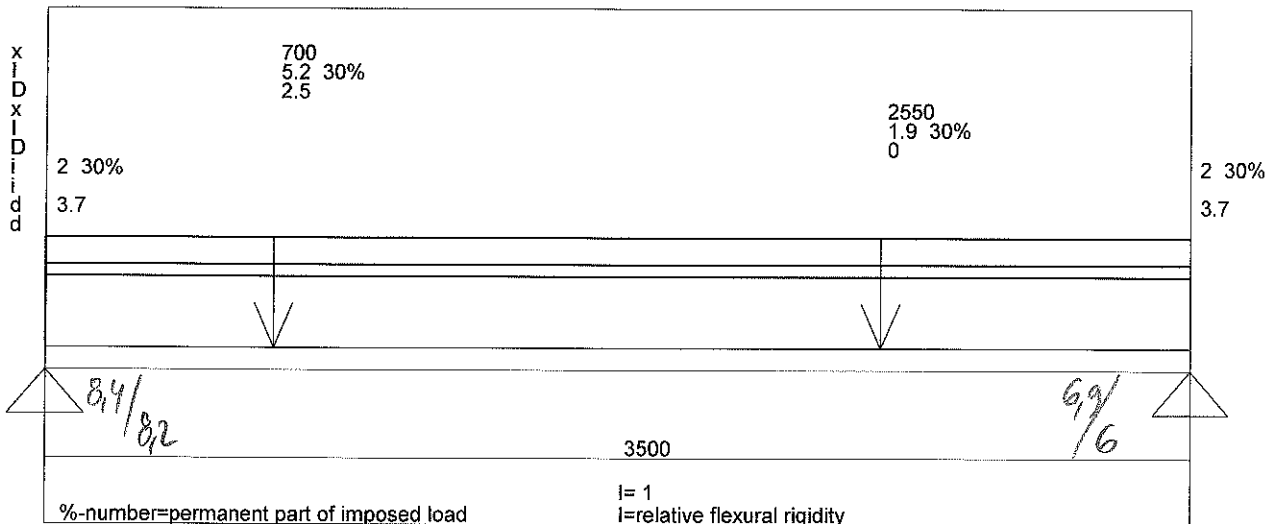

Licensed to: FINNLAMELLI OY

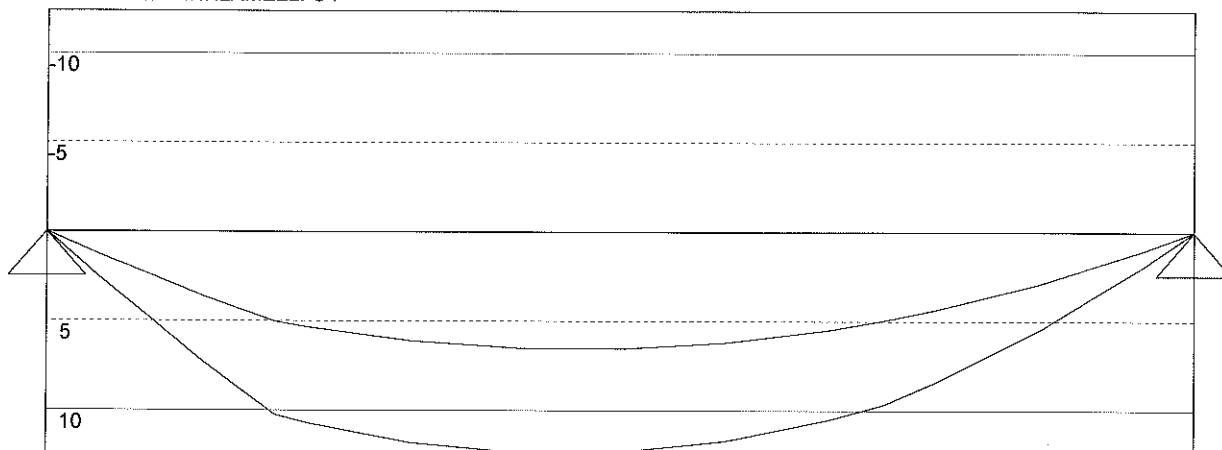

Licensed to: FINNLAMELLI OY

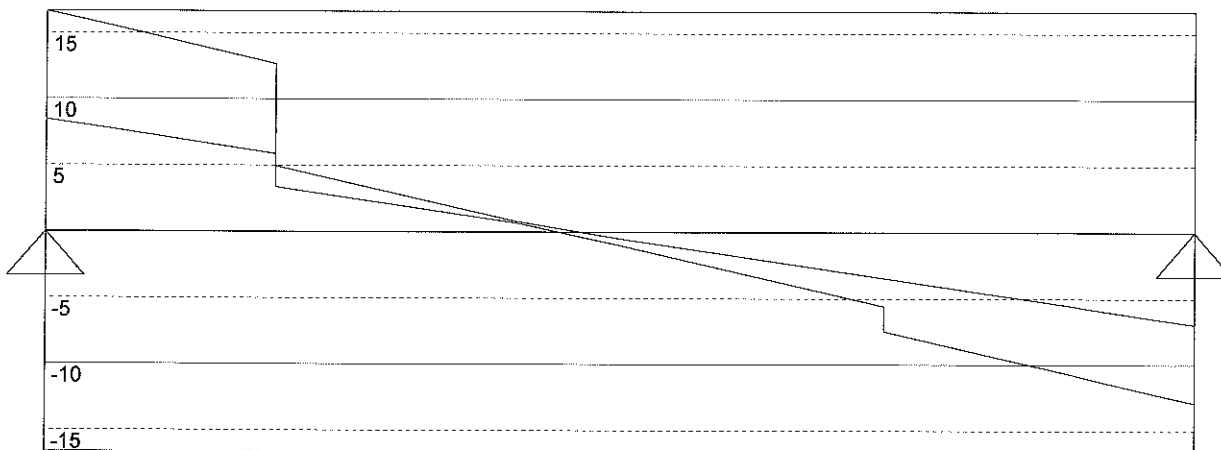

Load factor of dead load= 1 Load factor of imposed load= 1
 Load width 1 (m) (by which the loads
 has been multiplied during calculation)
 Max/Min reactions of beam [kN]
 16,647 12,898
 8,473 6,974

KER 76 x 300 B 2 Cf=1,00 Design method: Allowable stress design
 Increasing factor of the allowable stress 1,15
 Factored Moment/Moment capacity [kNm] 12,362 23,512 53 %
 Factored shear force/shear capacity [kN] 16,647 29,607 56 %

LVL (2) $1 \frac{1}{2} \times 11 \frac{3}{8}$

Deflection due to unfactored load (Deflection limit L/360)
 9,2 mm (94 %)

Beam Id: Lot#80 - MB *22*
 Structural Engineer:

Date 09-09-2019

Licensed to: FINNLAMELLI OY

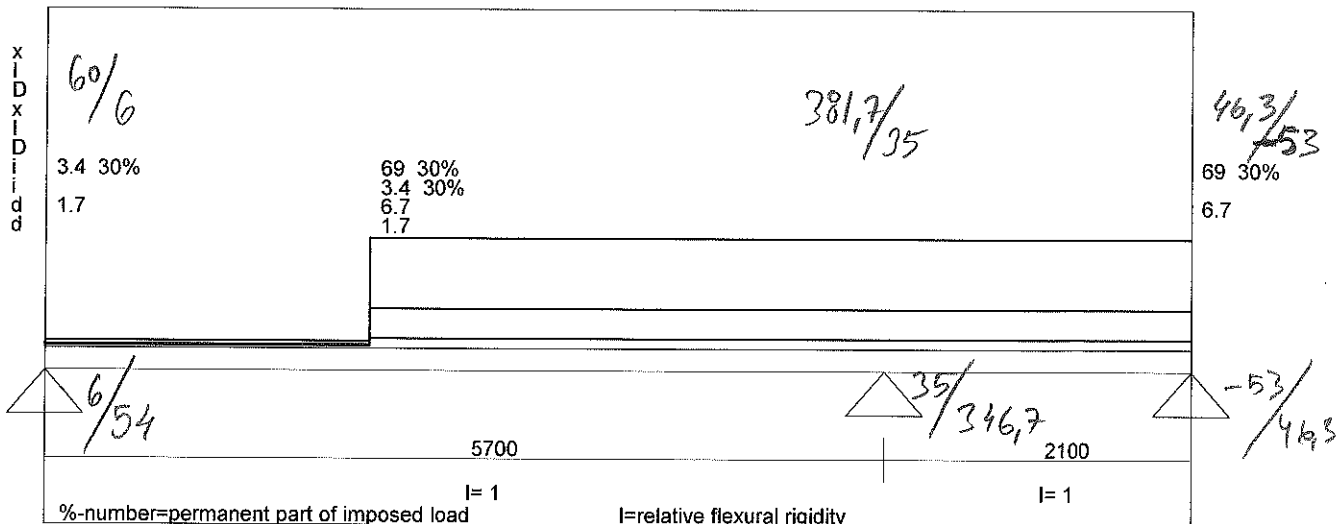

Licensed to: FINNLAMELLI OY

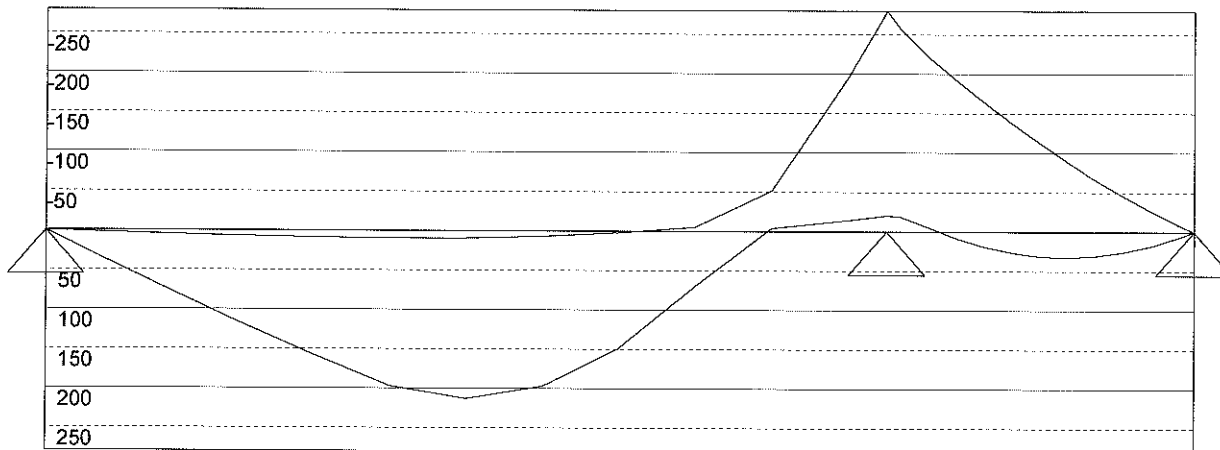

Licensed to: FINNLAMELLI OY

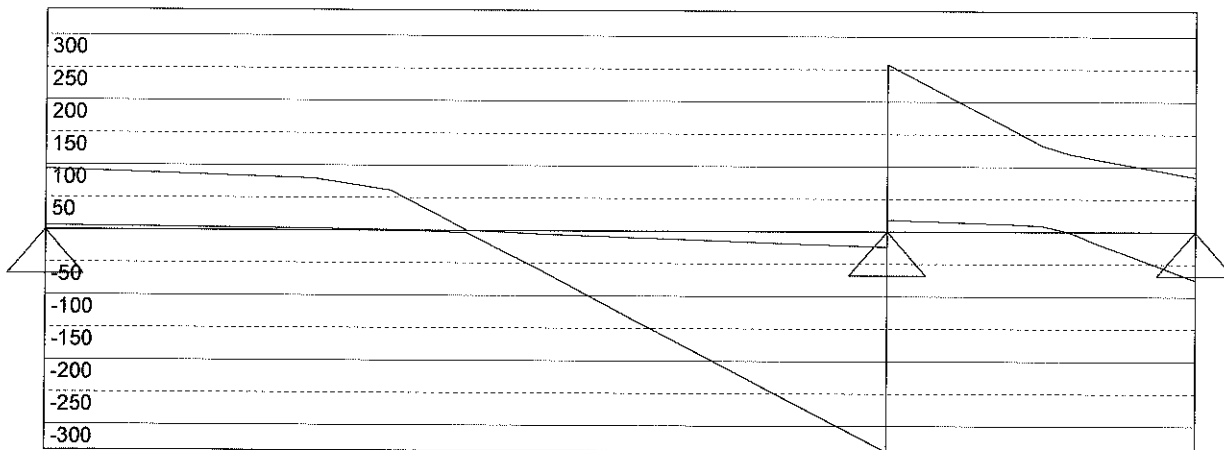

Load factor of dead load= 1.2 Load factor of imposed load= 1.6
 Load width 1 (m) (by which the loads
 has been multiplied during calculation)
 Max/Min reactions of beam [kN]
 93,534 596,836 74,470
 6,691 41,985 -84,388

HEB 280 (Class of section=1/1) G= 103 I(cm4)=19270 W(cm3)=1380 fy=235
 Factored Moment/Moment capacity [kNm] 279,433 360,490 78 %
 Factored shear force/shear capacity [kN] 339,410 387,891 88 %

W10 x 88

Sum infl M+S 0,82 (must be <=1) x= 5699 M=279,29 S=339,41
 Deflection due to unfactored load (Deflection limit L/360)
 9,4 mm (60 %) 0,2 mm (3 %)
 Attention! Ultimate limit design! Remember the load factors!!

Beam Id: Lot#80 - MB23

Date 10-09-2019

Structural Engineer:

Licensed to: FINNLAMELLI OY

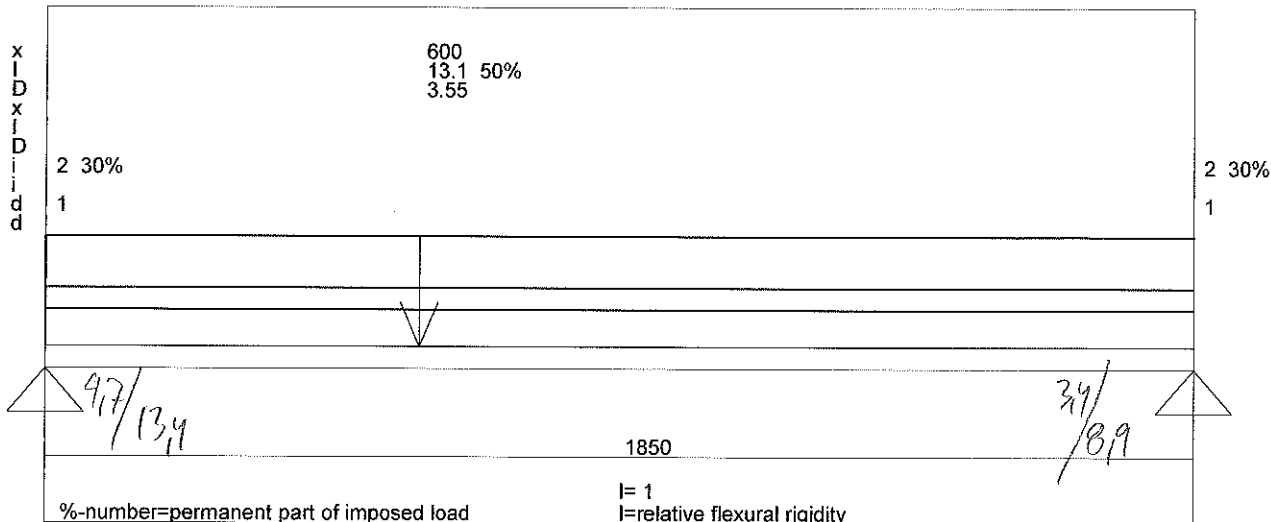

Licensed to: FINNLAMELLI OY

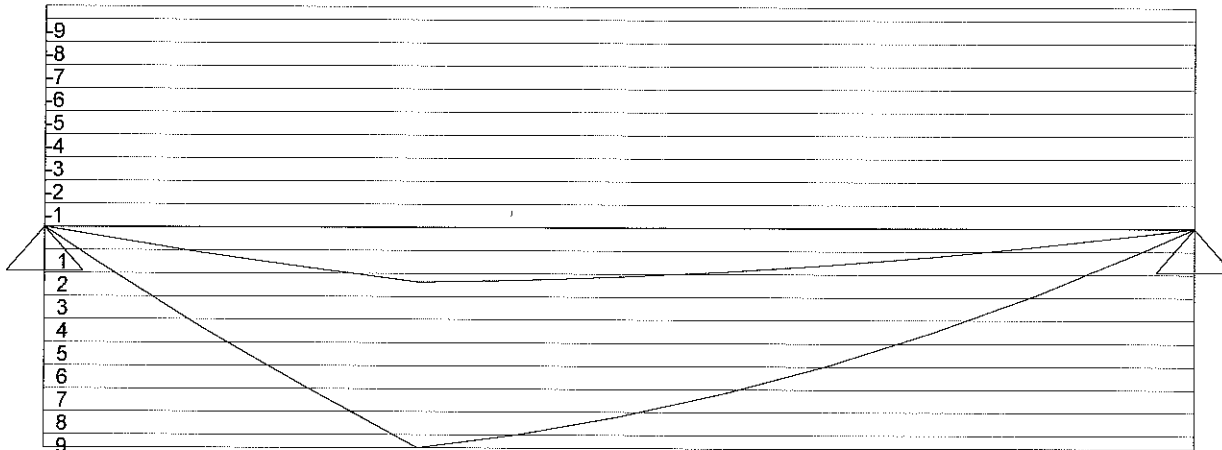

Licensed to: FINNLAMELLI OY

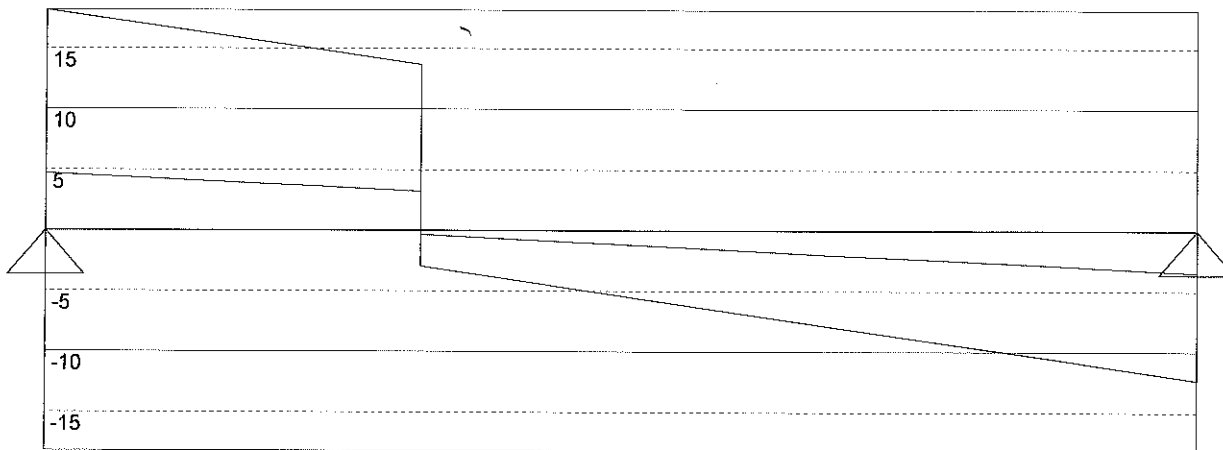

Load factor of dead load= 1 Load factor of imposed load= 1
 Load width 2.5 (m) (by which the loads
 has been multiplied during calculation)
 Max/Min reactions of beam [kN]
 18,186 12,337
 4,711 3,464

KER 76 x 240 B 2 Cf=1,00 Design method: Allowable stress design
 Increasing factor of the allowable stress 1,07
 Factored Moment/Moment capacity [kNm] 9,562 14,003 68 %
 Factored shear force/shear capacity [kN] 18,186 22,042 83 %

LUL (2) 1 1/2 x 9 1/2

Deflection due to unfactored load (Deflection limit L/360)
 3,3 mm (64 %)

Beam Id: Lot#80 - MB ~~MB~~ FLOOR JOIST
 Structural Engineer:

Date 04-09-2019

Licensed to: FINNLAMELLI OY

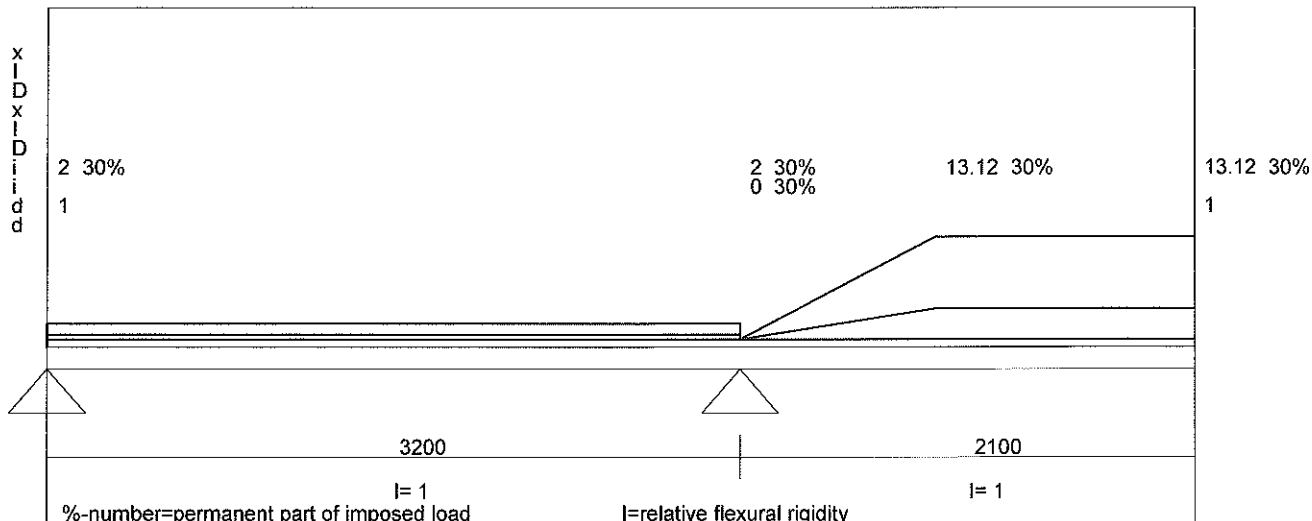

Licensed to: FINNLAMELLI OY

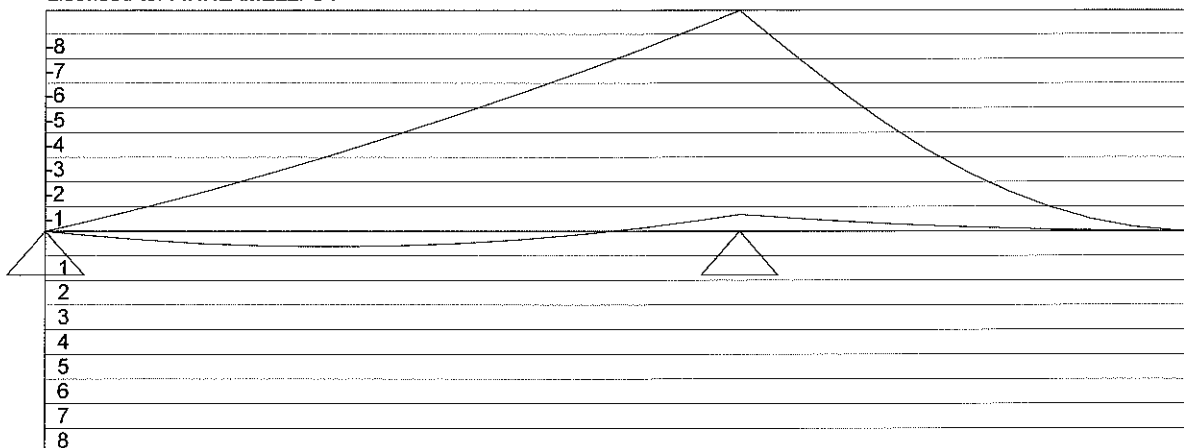

Licensed to: FINNLAMELLI OY

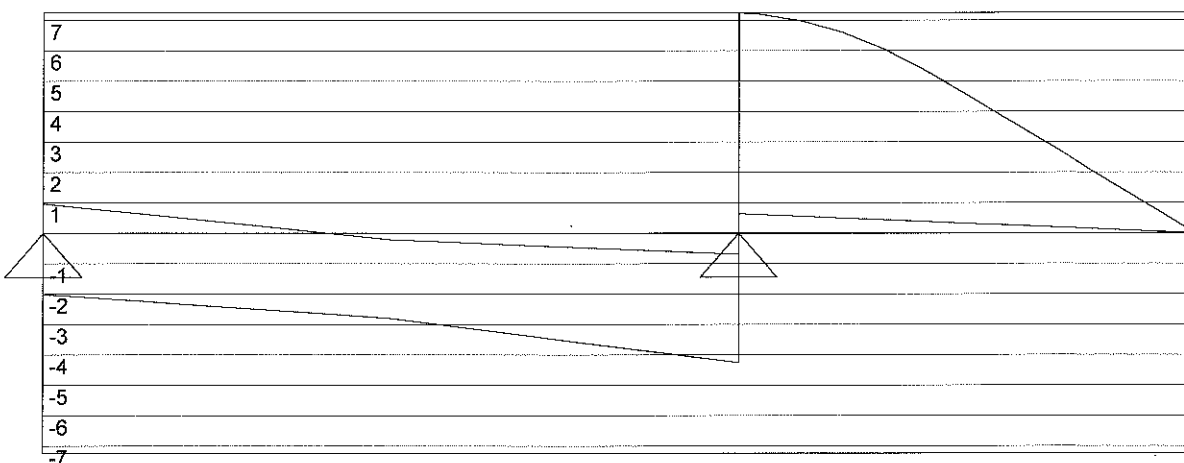

Load factor of dead load= 1 Load factor of imposed load= 1
 Load width .305 (m) (by which the loads
 has been multiplied during calculation)
 Max/Min reactions of beam [kN]
 0,961 11,505
 -2,018 1,339

KER 44 x 406 B 2 Cf=0,97 Design method: Allowable stress design
 Increasing factor of the allowable stress 1,02
 Factored Moment/Moment capacity [kNm] 8,955 21,441 42 %
 Factored shear force/shear capacity [kN] 7,243 20,633 35 %

Luc 1 3/4 x 16" @ 12"

Deflection due to unfactored load (Deflection limit L/360)/L/180!
 0,2 mm (3 %) 11,3 mm (97 %)

Beam Id: Lot#80 - MB *FLOOR JOIST*

Date 04-09-2019

Structural Engineer:

Licensed to: FINNLAMELLI OY

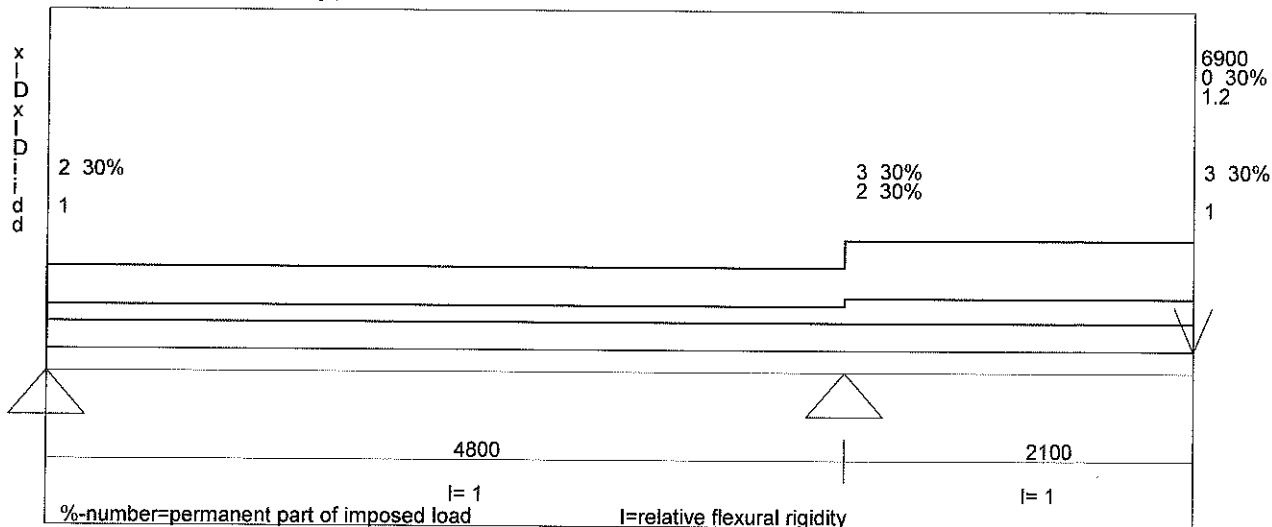

Licensed to: FINNLAMELLI OY

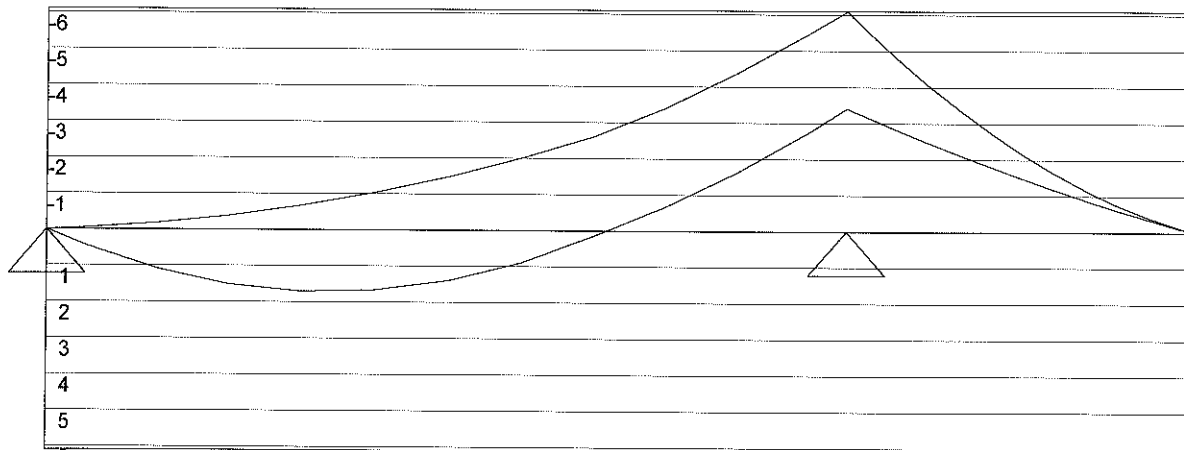

Licensed to: FINNLAMELLI OY

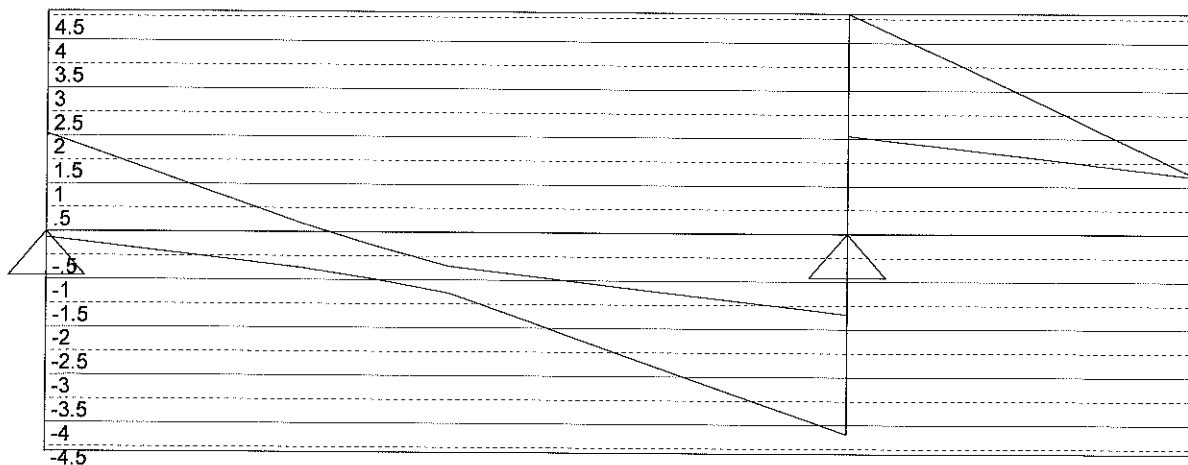

Load factor of dead load= 1 Load factor of imposed load= 1

Load width .406 (m) (by which the loads has been multiplied during calculation)

Max/Min reactions of beam [kN]

2,043 8,803
-0,129 3,738

KER 44 x 406 B 2 Cf=0,97 Design method: Allowable stress design increasing factor of the allowable stress 1,11

Factored Moment/Moment capacity [kNm] 6,099 23,265 26 %

Factored shear force/shear capacity [kN] 4,610 22,388 21 %

LVL 1 3/4" x 16" @ 16"

Deflection due to unfactored load (Deflection limit L/360)/L/180!

0,9 mm (7 %) 8,6 mm (73 %)

Steel Beam

Lic. #: KW-06004069

Description: MB22

File = P:\9SEXEV-MS82GGD-6\Enercalc.ec6
Software copyright ENERCALC, INC. 1983-2018, Build:10.18.12.13

Licensee: ENSIGN ENGINEERING

CODE REFERENCES

Calculations per AISC 360-16, IBC 2018, CBC 2019, ASCE 7-16
Load Combination Set: ASCE 7-10

Material Properties

Analysis Method: Allowable Strength Design
Beam Bracing: Beam is Fully Braced against lateral-torsional buckling
Bending Axis: Major Axis Bending

Fy: Steel Yield: 50.0 ksi
E: Modulus: 29,000.0 ksi

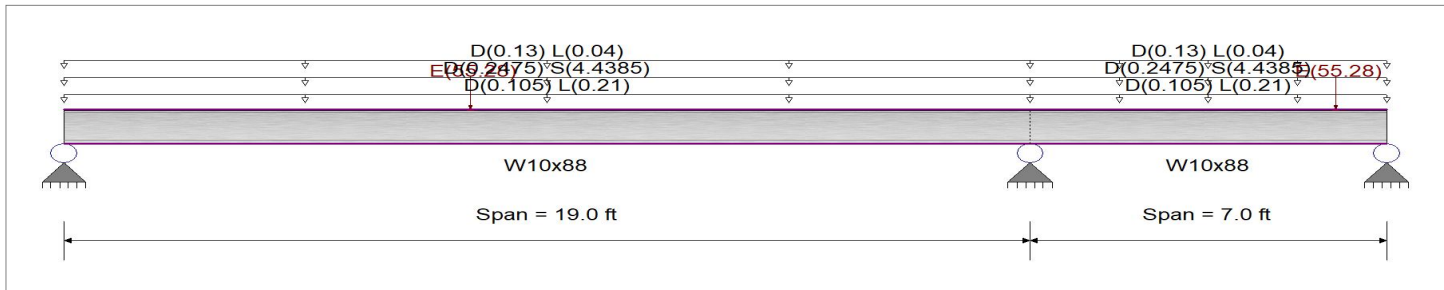

Applied Loads

Service loads entered. Load Factors will be applied for calculations.

Beam self weight NOT internally calculated and added

Load for Span Number 1

Uniform Load: D = 0.020, L = 0.040 ksf, Tributary Width = 5.250 ft, (Floor)

Uniform Load: D = 0.0150, S = 0.2690 ksf, Tributary Width = 16.50 ft, (Roof)

Uniform Load: D = 0.130, L = 0.040 ksf, Tributary Width = 1.0 ft, (Garage)

Point Load: E = 55.280 k @ 8.0 ft

Load for Span Number 2

Uniform Load: D = 0.020, L = 0.040 ksf, Tributary Width = 5.250 ft, (Floor)

Uniform Load: D = 0.0150, S = 0.2690 ksf, Tributary Width = 16.50 ft, (Roof)

Uniform Load: D = 0.130, L = 0.040 ksf, Tributary Width = 1.0 ft, (Garage)

Point Load: E = 55.280 k @ 6.0 ft, (Hold Down)

DESIGN SUMMARY

Design OK

Maximum Bending Stress Ratio =	0.783 : 1	Maximum Shear Stress Ratio =	0.470 : 1
Section used for this span	W10x88	Section used for this span	W10x88
Ma: Applied	220.837 k-ft	Va: Applied	61.371 k
Mn / Omega: Allowable	281.936 k-ft	Vn/Omega: Allowable	130.680 k
Load Combination	+D+0.750L+0.750S+0.5250E	Load Combination	+D+0.750L+0.750S+0.5250E
Location of maximum on span	7.980ft	Location of maximum on span	19.000 ft
Span # where maximum occurs	Span # 1	Span # where maximum occurs	Span # 1
Maximum Deflection			
Max Downward Transient Deflection	0.516 in	Ratio =	441 >=360
Max Upward Transient Deflection	-0.040 in	Ratio =	2,125 >=360
Max Downward Total Deflection	0.688 in	Ratio =	331 >=240
Max Upward Total Deflection	-0.053 in	Ratio =	1585 >=240

Maximum Forces & Stresses for Load Combinations

Load Combination	Segment Length	Span #	Max Stress Ratios		Summary of Moment Values						Summary of Shear Values				
			M	V	Mmax +	Mmax -	Ma Max	Mnx	Mnx/Omega	Cb	Rm	Va Max	Vnx	Vnx/Omega	
D Only															
Dsgn. L = 19.00 ft		1	0.059	0.042	14.22	-16.71	16.71	470.83	281.94	1.00	1.00	5.46	196.02	130.68	



Steel Beam

File = P:\9SEXEV-MS82GGD-6\Enercalc.ec6 .
 Software copyright ENERCALC, INC. 1983-2018, Build:10.18.12.13 .

Lic. # : KW-06004069

Licensee : ENSIGN ENGINEERING

Description : MB22

Load Combination	Segment Length	Span #	Max Stress Ratios		Summary of Moment Values						Summary of Shear Values			
			M	V	Mmax +	Mmax -	Ma Max	Mnx	Mnx/Omega	Cb	Rm	Va Max	Vnx	Vnx/Omega
Dsgn. L = 7.00 ft		2	0.059	0.031		-16.71	16.71	470.83	281.94	1.00	1.00	4.08	196.02	130.68
+D+L														
Dsgn. L = 19.00 ft		1	0.090	0.063	21.59	-25.36	25.36	470.83	281.94	1.00	1.00	8.29	196.02	130.68
Dsgn. L = 7.00 ft		2	0.090	0.047		-25.36	25.36	470.83	281.94	1.00	1.00	6.19	196.02	130.68
+D+S														
Dsgn. L = 19.00 ft		1	0.604	0.426	145.04	-170.39	170.39	470.83	281.94	1.00	1.00	55.72	196.02	130.68
Dsgn. L = 7.00 ft		2	0.604	0.318		-170.39	170.39	470.83	281.94	1.00	1.00	41.56	196.02	130.68
+D+0.750L														
Dsgn. L = 19.00 ft		1	0.082	0.058	19.75	-23.20	23.20	470.83	281.94	1.00	1.00	7.59	196.02	130.68
Dsgn. L = 7.00 ft		2	0.082	0.043		-23.20	23.20	470.83	281.94	1.00	1.00	5.66	196.02	130.68
+D+0.750L+0.750S														
Dsgn. L = 19.00 ft		1	0.491	0.346	117.86	-138.46	138.46	470.83	281.94	1.00	1.00	45.28	196.02	130.68
Dsgn. L = 7.00 ft		2	0.491	0.258		-138.46	138.46	470.83	281.94	1.00	1.00	33.78	196.02	130.68
+D+0.70E														
Dsgn. L = 19.00 ft		1	0.538	0.206	151.75	-114.87	151.75	470.83	281.94	1.00	1.00	26.92	196.02	130.68
Dsgn. L = 7.00 ft		2	0.407	0.181	18.04	-114.87	114.87	470.83	281.94	1.00	1.00	23.63	196.02	130.68
+D+0.750L+0.750S+0.5250E														
Dsgn. L = 19.00 ft		1	0.783	0.470	220.84	-212.08	220.84	470.83	281.94	1.00	1.00	61.37	196.02	130.68
Dsgn. L = 7.00 ft		2	0.752	0.371	6.48	-212.08	212.08	470.83	281.94	1.00	1.00	48.44	196.02	130.68
+0.60D														
Dsgn. L = 19.00 ft		1	0.036	0.025	8.53	-10.02	10.02	470.83	281.94	1.00	1.00	3.28	196.02	130.68
Dsgn. L = 7.00 ft		2	0.036	0.019		-10.02	10.02	470.83	281.94	1.00	1.00	2.45	196.02	130.68
+0.60D+0.70E														
Dsgn. L = 19.00 ft		1	0.518	0.189	146.07	-108.19	146.07	470.83	281.94	1.00	1.00	24.74	196.02	130.68
Dsgn. L = 7.00 ft		2	0.384	0.168	18.42	-108.19	108.19	470.83	281.94	1.00	1.00	22.00	196.02	130.68

Overall Maximum Deflections

Load Combination	Span	Max. "-" Defl	Location in Span	Load Combination	Max. "+" Defl	Location in Span
+D+0.750L+0.750S+0.5250E	1	0.6882	8.436		0.0000	0.000
	2	0.0000	8.436	+D+0.750L+0.750S+0.5250E	-0.0530	2.660

Vertical Reactions

Load Combination	Support 1	Support 2	Support 3
Overall MAXimum	43.629	109.811	27.350
Overall MINimum	1.919	4.942	-0.362
D Only	3.704	9.538	-0.698
+D+L	5.624	14.481	-1.060
+D+S	37.782	97.282	-7.118
+D+0.750L	5.144	13.245	-0.969
+D+0.750L+0.750S	30.702	79.053	-5.784
+D+0.70E	20.941	50.549	18.447
+D+0.750L+0.750S+0.5250E	43.629	109.811	8.575
+0.60D	2.223	5.723	-0.419
+0.60D+0.70E	19.459	46.734	18.726
L Only	1.919	4.942	-0.362
S Only	34.077	87.744	-6.420
E Only	24.624	58.586	27.350

Support notation : Far left is #1

Values in KIPS



Steel Column

File = P:\9SEXEV-MS82GGD-6\Enercalc.ec6 .
 Software copyright ENERCALC, INC. 1983-2018, Build:10.18.12.13 .

Lic. # : KW-06004069

Licensee : ENSIGN ENGINEERING

Description : TS Column

Code References

Calculations per AISC 360-16, IBC 2018, CBC 2019, ASCE 7-10
 Load Combinations Used : ASCE 7-10

General Information

Steel Section Name :	HSS5x5x3/8	Overall Column Height	9.50 ft
Analysis Method :	Allowable Strength	Top & Bottom Fixity	Top & Bottom Pinned
Steel Stress Grade		Brace condition for deflection (buckling) along columns :	
Fy : Steel Yield	46.0 ksi	X-X (width) axis :	
E : Elastic Bending Modulus	29,000.0 ksi	Unbraced Length for X-X Axis buckling =	9.50 ft, K = 1.0
		Y-Y (depth) axis :	
		Unbraced Length for Y-Y Axis buckling =	9.50 ft, K = 1.0

Applied Loads

Service loads entered. Load Factors will be applied for calculations.

Column self weight included : 211.865 lbs * Dead Load Factor

AXIAL LOADS . . .

MB22: Axial Load at 9.50 ft, D = 9.540, L = 4.940, S = 87.740, E = 58.586 k

DESIGN SUMMARY

Bending & Shear Check Results

PASS Max. Axial+Bending Stress Ratio = **0.8299** : 1
 Load Combination **+D+0.750L+0.750S+0.5250E**
 Location of max.above base **0.0 ft**
 At maximum location values are . . .
 Pa : Axial **110.020 k**
 Pn / Omega : Allowable **132.574 k**
 Ma-x : Applied **0.0 k-ft**
 Mn-x / Omega : Allowable **24.331 k-ft**
 Ma-y : Applied **0.0 k-ft**
 Mn-y / Omega : Allowable **24.331 k-ft**

Maximum Load Reactions . . .
 Top along X-X **0.0 k**
 Bottom along X-X **0.0 k**
 Top along Y-Y **0.0 k**
 Bottom along Y-Y **0.0 k**
 Maximum Load Deflections . . .
 Along Y-Y **0.0 in** at **0.0ft** above base
 for load combination :
 Along X-X **0.0 in** at **0.0ft** above base
 for load combination :

PASS Maximum Shear Stress Ratio = **0.0** : 1
 Load Combination
 Location of max.above base **0.0 ft**
 At maximum location values are . . .
 Va : Applied **0.0 k**
 Vn / Omega : Allowable **0.0 k**

Load Combination Results

Load Combination	Maximum Axial + Bending Stress Ratios			Cbx	Cby	KxLx/Rx	KyLy/Ry	Maximum Shear Ratios		
	Stress Ratio	Status	Location					Stress Ratio	Status	Location
D Only	0.074	PASS	0.00 ft	1.00	1.00	60.96	60.96	0.000	PASS	0.00 ft
+D+L	0.111	PASS	0.00 ft	1.00	1.00	60.96	60.96	0.000	PASS	0.00 ft
+D+S	0.735	PASS	0.00 ft	1.00	1.00	60.96	60.96	0.000	PASS	0.00 ft
+D+0.750L	0.102	PASS	0.00 ft	1.00	1.00	60.96	60.96	0.000	PASS	0.00 ft
+D+0.750L+0.750S	0.598	PASS	0.00 ft	1.00	1.00	60.96	60.96	0.000	PASS	0.00 ft
+D+0.70E	0.383	PASS	0.00 ft	1.00	1.00	60.96	60.96	0.000	PASS	0.00 ft
+D+0.750L+0.750S+0.5250E	0.830	PASS	0.00 ft	1.00	1.00	60.96	60.96	0.000	PASS	0.00 ft
+0.60D	0.044	PASS	0.00 ft	1.00	1.00	60.96	60.96	0.000	PASS	0.00 ft
+0.60D+0.70E	0.353	PASS	0.00 ft	1.00	1.00	60.96	60.96	0.000	PASS	0.00 ft

Maximum Reactions

Note: Only non-zero reactions are listed.

Load Combination	Axial Reaction	X-X Axis Reaction		Y-Y Axis Reaction	Mx - End Moments		My - End Moments	
	@ Base	@ Base	@ Top	@ Base	@ Base	@ Top	@ Base	@ Top
D Only	9.752							
+D+L	14.692							
+D+S	97.492							
+D+0.750L	13.457							
+D+0.750L+0.750S	79.262							
+D+0.70E	50.762							



Steel Column

File = P:\9SEXEV-MS82GGD-6\Enercalc.ec6 .
 Software copyright ENERCALC, INC. 1983-2018, Build:10.18.12.13 .

Lic. # : KW-06004069

Licensee : ENSIGN ENGINEERING

Description : TS Column

Note: Only non-zero reactions are listed.

Maximum Reactions

Load Combination	Axial Reaction @ Base	X-X Axis Reaction @ Base	X-X Axis Reaction @ Top	k	Y-Y Axis Reaction @ Base	Y-Y Axis Reaction @ Top	Mx - End Moments @ Base	Mx - End Moments @ Top	k-ft	My - End Moments @ Base	My - End Moments @ Top
+D+0.750L+0.750S+0.5250E	110.020										
+0.60D	5.851										
+0.60D+0.70E	46.861										
L Only	4.940										
S Only	87.740										
E Only	58.586										

Extreme Reactions

Item	Extreme Value	Axial Reaction @ Base	X-X Axis Reaction @ Base	X-X Axis Reaction @ Top	k	Y-Y Axis Reaction @ Base	Y-Y Axis Reaction @ Top	Mx - End Moments @ Base	Mx - End Moments @ Top	k-ft	My - End Moments @ Base	My - End Moments @ Top
Axial @ Base	Maximum	110.020										
"	Minimum	4.940										
Reaction, X-X Axis Base	Maximum	9.752										
"	Minimum	9.752										
Reaction, Y-Y Axis Base	Maximum	9.752										
"	Minimum	9.752										
Reaction, X-X Axis Top	Maximum	9.752										
"	Minimum	9.752										
Reaction, Y-Y Axis Top	Maximum	9.752										
"	Minimum	9.752										
Moment, X-X Axis Base	Maximum	9.752										
"	Minimum	9.752										
Moment, Y-Y Axis Base	Maximum	9.752										
"	Minimum	9.752										
Moment, X-X Axis Top	Maximum	9.752										
"	Minimum	9.752										
Moment, Y-Y Axis Top	Maximum	9.752										
"	Minimum	9.752										

Maximum Deflections for Load Combinations

Load Combination	Max. X-X Deflection	Distance	Max. Y-Y Deflection	Distance
D Only	0.0000 in	0.000 ft	0.000 in	0.000 ft
+D+L	0.0000 in	0.000 ft	0.000 in	0.000 ft
+D+S	0.0000 in	0.000 ft	0.000 in	0.000 ft
+D+0.750L	0.0000 in	0.000 ft	0.000 in	0.000 ft
+D+0.750L+0.750S	0.0000 in	0.000 ft	0.000 in	0.000 ft
+D+0.70E	0.0000 in	0.000 ft	0.000 in	0.000 ft
+D+0.750L+0.750S+0.5250E	0.0000 in	0.000 ft	0.000 in	0.000 ft
+0.60D	0.0000 in	0.000 ft	0.000 in	0.000 ft
+0.60D+0.70E	0.0000 in	0.000 ft	0.000 in	0.000 ft
L Only	0.0000 in	0.000 ft	0.000 in	0.000 ft
S Only	0.0000 in	0.000 ft	0.000 in	0.000 ft
E Only	0.0000 in	0.000 ft	0.000 in	0.000 ft

Steel Section Properties : HSS5x5x3/8

Steel Column

File = P:\9SEXEV-MS82GGD-6\Enercalc.ec6 .
Software copyright ENERCALC, INC. 1983-2018, Build:10.18.12.13 .

Lic. # : KW-06004069

Licensee : ENSGN ENGINEERING

Description : TS Column

Steel Section Properties : HSS5x5x3/8

Depth	=	5.000 in	I xx	=	21.70 in ⁴	J	=	36.100 in ⁴
Design Thick	=	0.349 in	S xx	=	8.68 in ³			
Width	=	5.000 in	R xx	=	1.870 in			
Wall Thick	=	0.375 in	Zx	=	10.600 in ³			
Area	=	6.180 in ²	I yy	=	21.700 in ⁴	C	=	14.900 in ³
Weight	=	22.302 plf	S yy	=	8.680 in ³			
			R yy	=	1.870 in			

Ycg = 0.000 in

Sketches

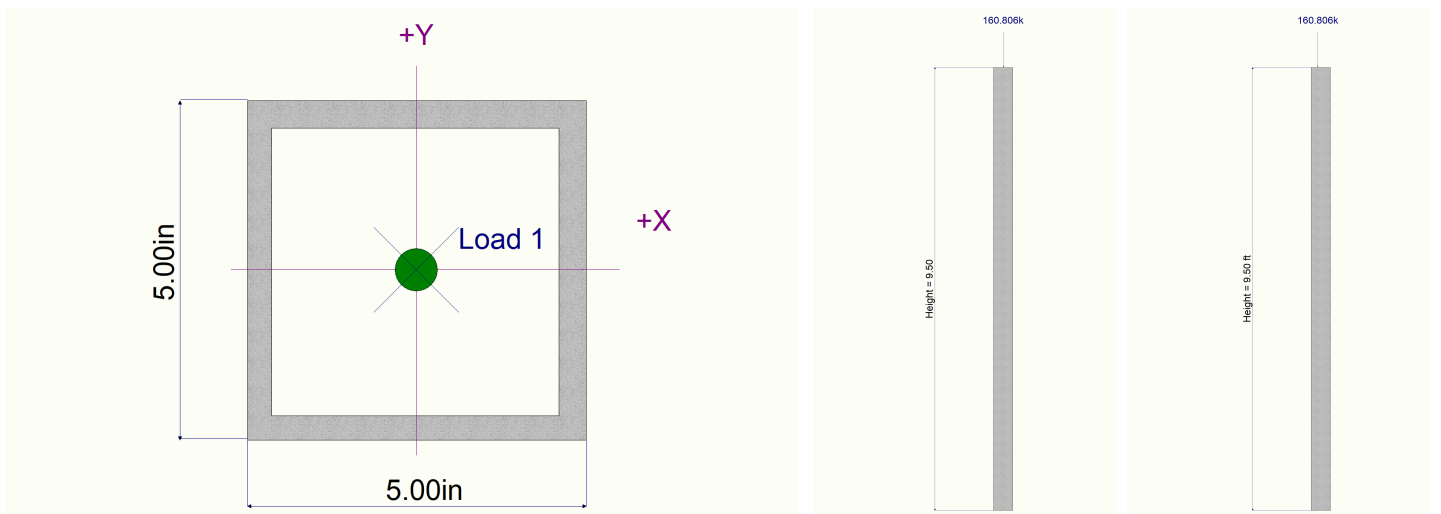

Beam Id: Lot#80 - RB /
 Structural Engineer:

Date 03-09-2019

Licensed to: FINNLAMELLI OY

MAX
 MIN
 x
 D
 x
 D
 i
 i
 d
 d

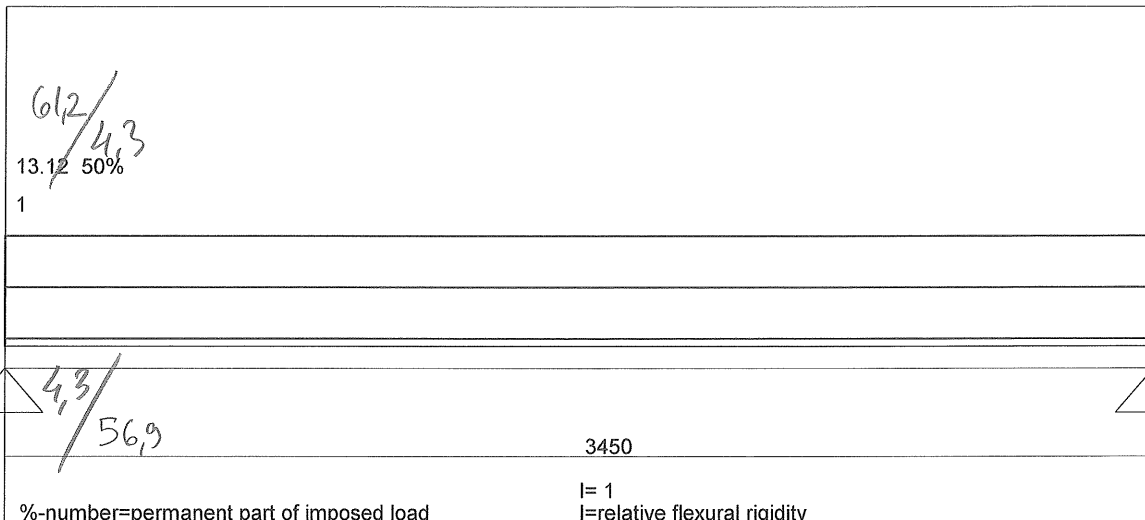

Licensed to: FINNLAMELLI OY

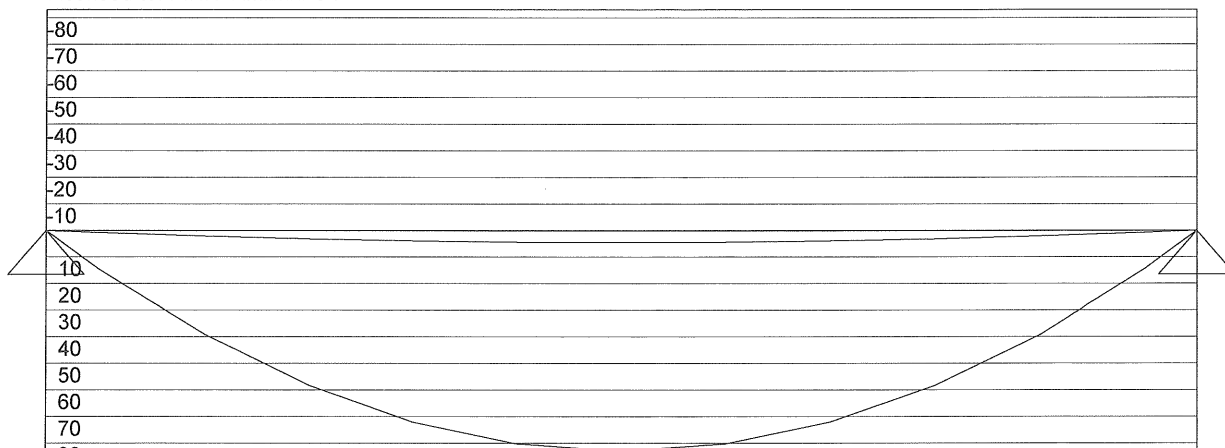

Licensed to: FINNLAMELLI OY

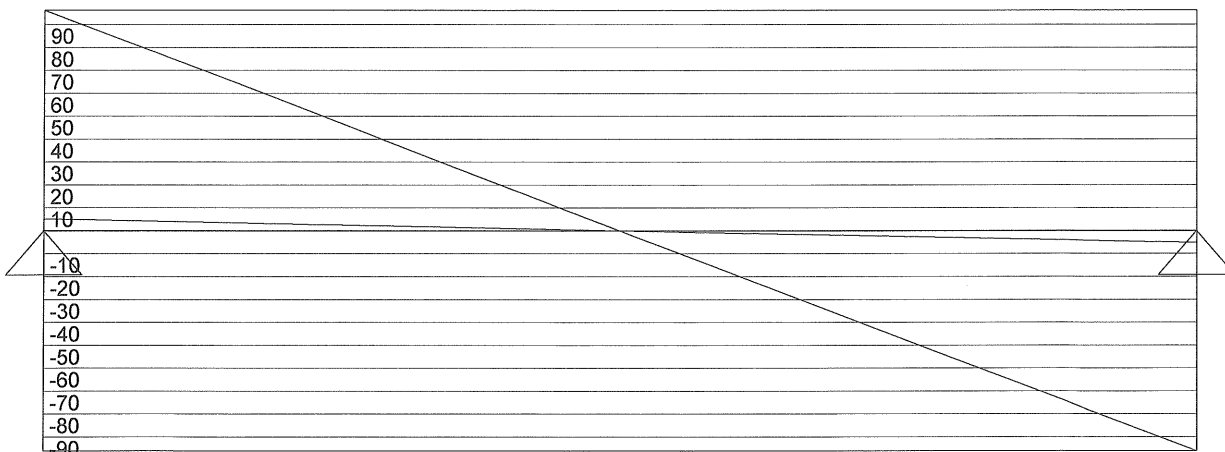

Load factor of dead load= 1.2 Load factor of imposed load= 1.6
 Load width 2.514 (m) (by which the loads
 has been multiplied during calculation)
 Max/Min reactions of beam [kN]
 96,220 96,239
 5,203 5,204

HEB 160 (Class of section=1/1) G= 42,6 I(cm4)=2492 W(cm3)=311 fy=235
 Factored Moment/Moment capacity [kNm] 83,006 83,190 100 %
 Factored shear force/shear capacity [kN] 96,220 165,816 58 %

Sum infl M+S 0,99 (must be <=1) x= 1725 M=83,01 S=0
 Deflection due to unfactored load (Deflection limit L/240)
 12,6 mm (87 %)

Attention! Ultimate limit design! Remember the load factors!!

W8x21 OK
 (W6x25)

Beam Id: Lot#80 - RB

Date 03-09-2019

Structural Engineer:

Licensed to: FINNLAMELLI OY

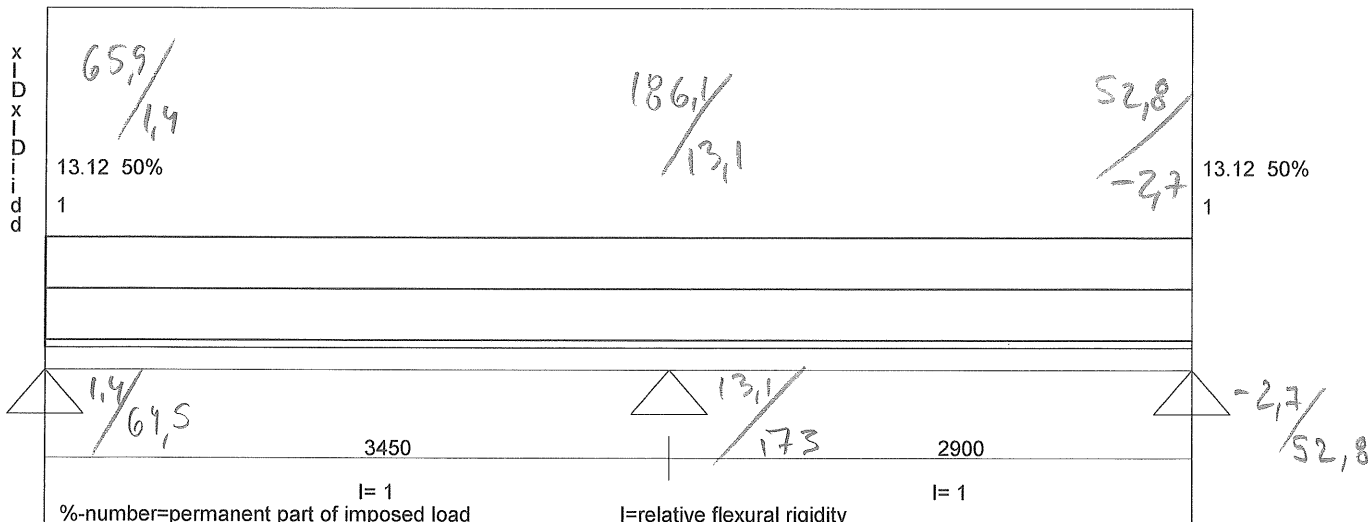

Licensed to: FINNLAMELLI OY

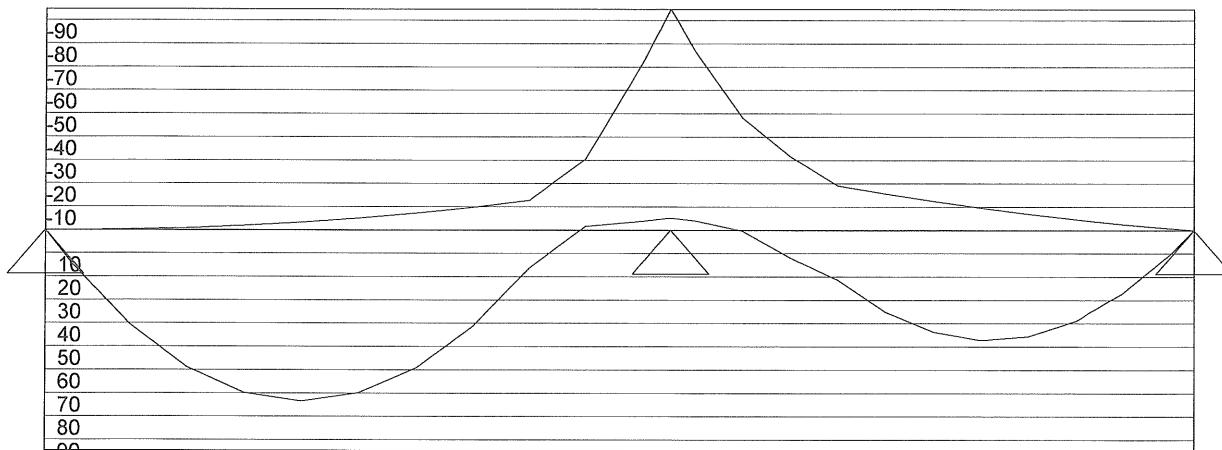

Licensed to: FINNLAMELLI OY

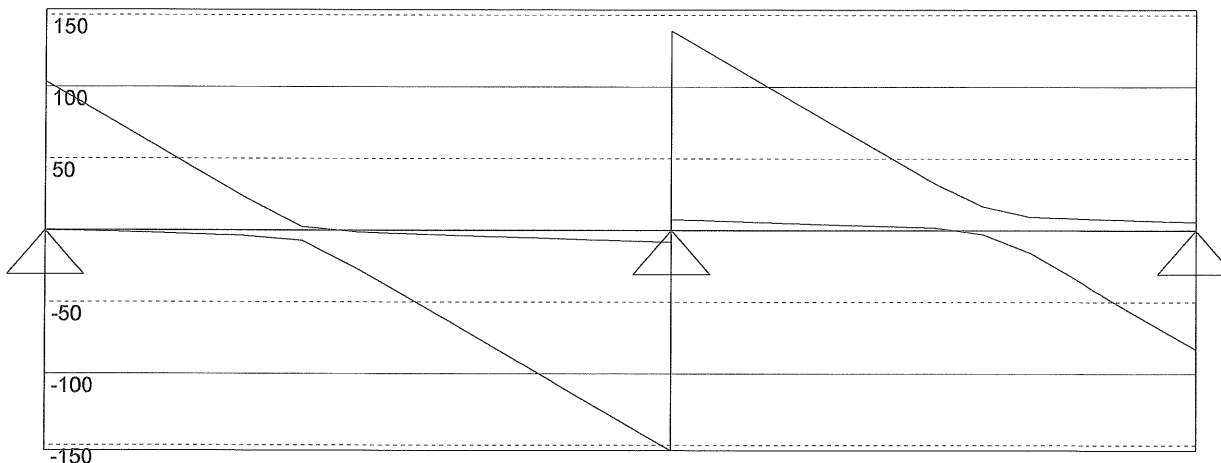

Load factor of dead load= 1.2 Load factor of imposed load= 1.6

Load width 3.3 (m) (by which the loads has been multiplied during calculation)

Max/Min reactions of beam [kN]

103,686 292,587 83,218

0,506 15,821 -5,716

HEB 180 (Class of section=1/1) G= 51,2 I(cm4)=3831 W(cm3)=426 fy=235

Factored Moment/Moment capacity [kNm] 94,680 113,270 84 %

Factored shear force/shear capacity [kN] 153,758 198,951 77 %

WB x 28

Sum infl M+S 0,87 (must be <=1) x= 3449 M=94,67 S=153,76

Deflection due to unfactored load (Deflection limit L/240)

6,1 mm (43 %) 2,6 mm (21 %)

Attention! Ultimate limit design! Remember the load factors!!

Beam Id: Lot#80 - RB **3**
 Structural Engineer:

Date 30-08-2019

Licensed to: FINNLAMELLI OY

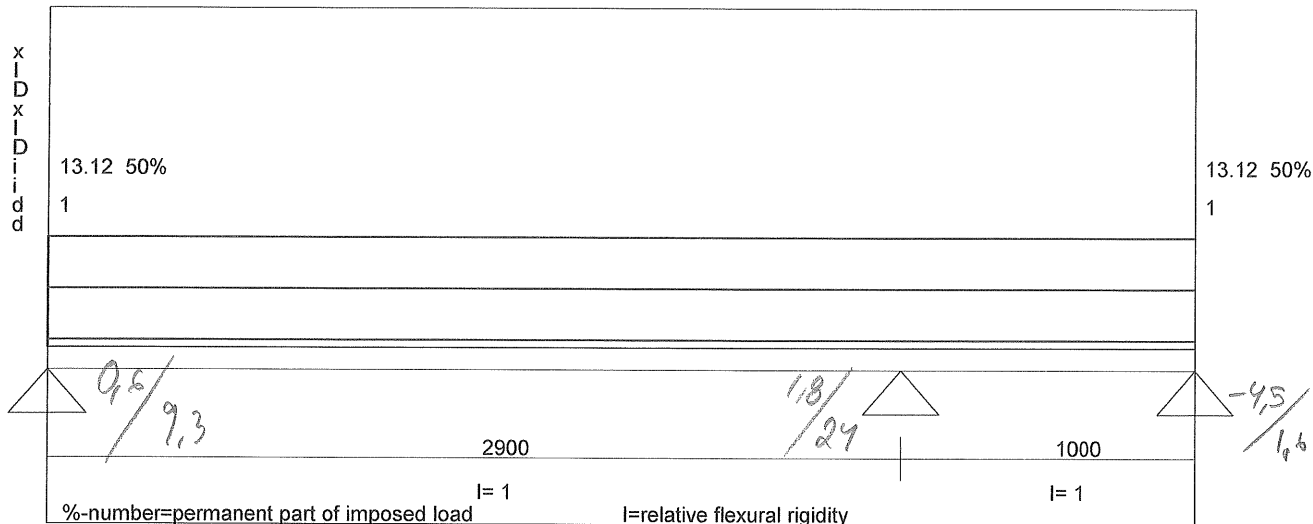

Licensed to: FINNLAMELLI OY

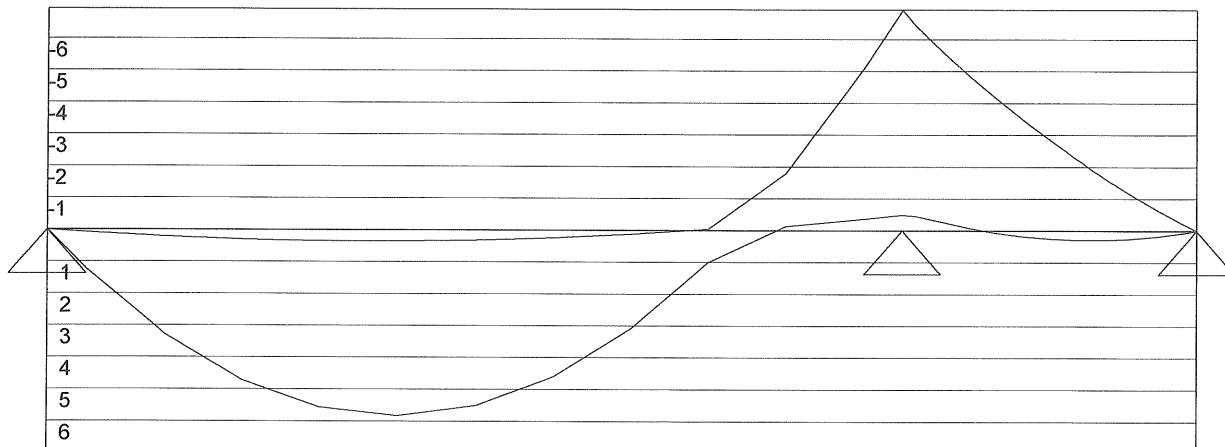

Licensed to: FINNLAMELLI OY

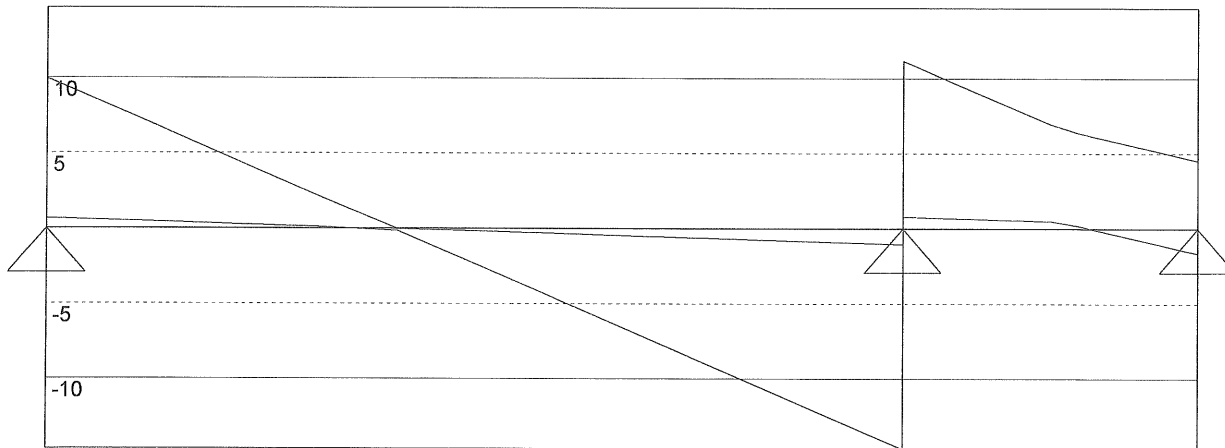

Load factor of dead load= 1 Load factor of imposed load= 1
 Load width .6 (m) (by which the loads
 has been multiplied during calculation)
 Max/Min reactions of beam [kN]
 9,939 25,824 1,651
 0,657 1,829 -4,526

T24 164 x 260 B 2 Cf=1,00 Design method: Allowable stress design
 Increasing factor of the allowable stress 1,02
 Factored Moment/Moment capacity [kNm] 6,920 18,058 38 %
 Factored shear force/shear capacity [kN] 14,668 27,781 53 %

(1) PROFILE

Deflection due to unfactored load (Deflection limit L/240)
 2,7 mm (23 %) 0,0 mm (0 %)

Beam Id: Lot#80 - RB *4*

Date 30-08-2019

Structural Engineer:

Licensed to: FINNLAMELLI OY

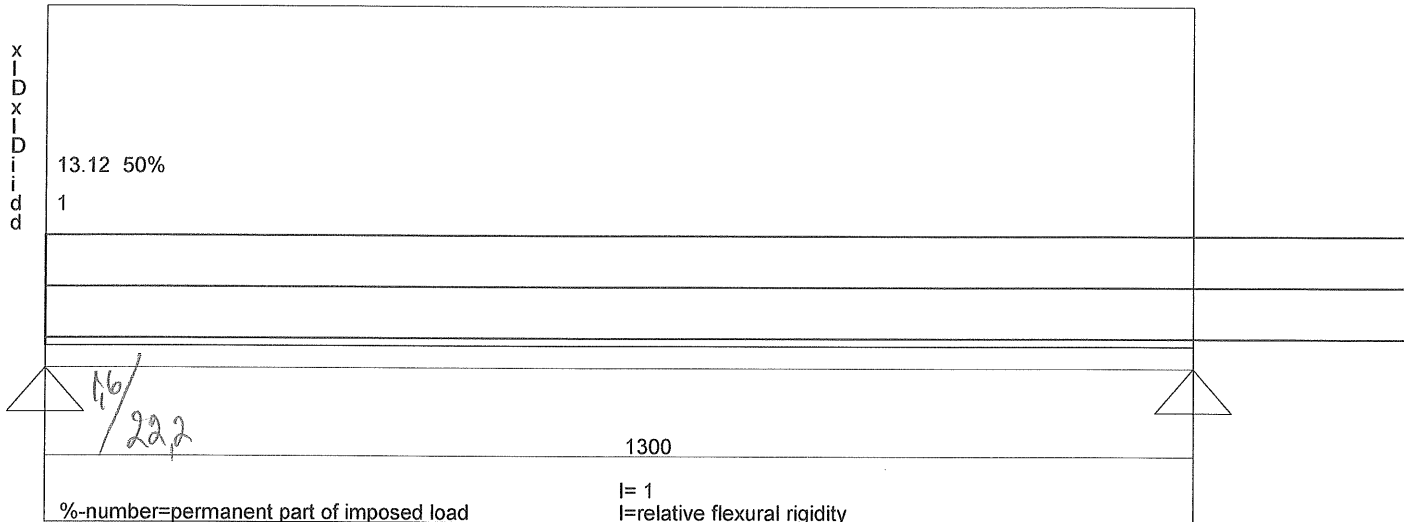

Licensed to: FINNLAMELLI OY

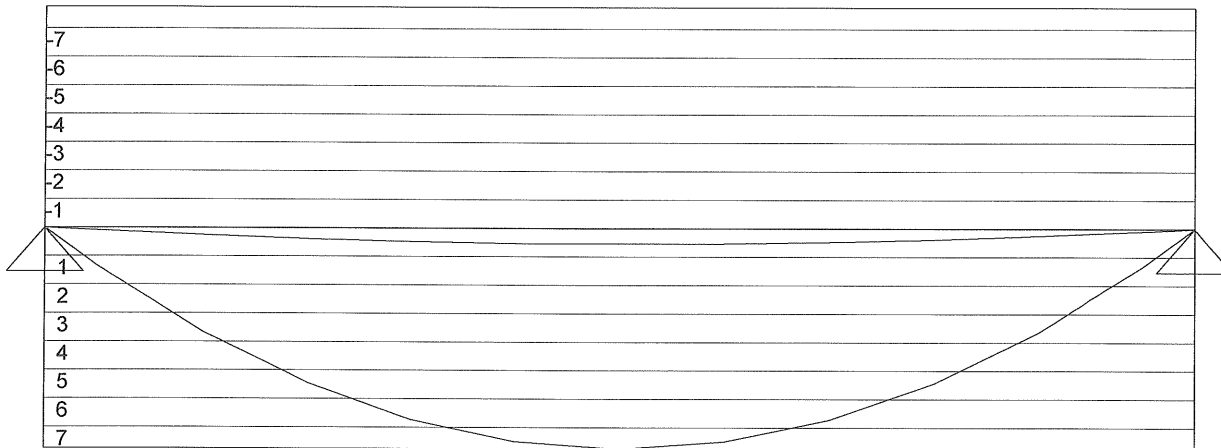

Licensed to: FINNLAMELLI OY

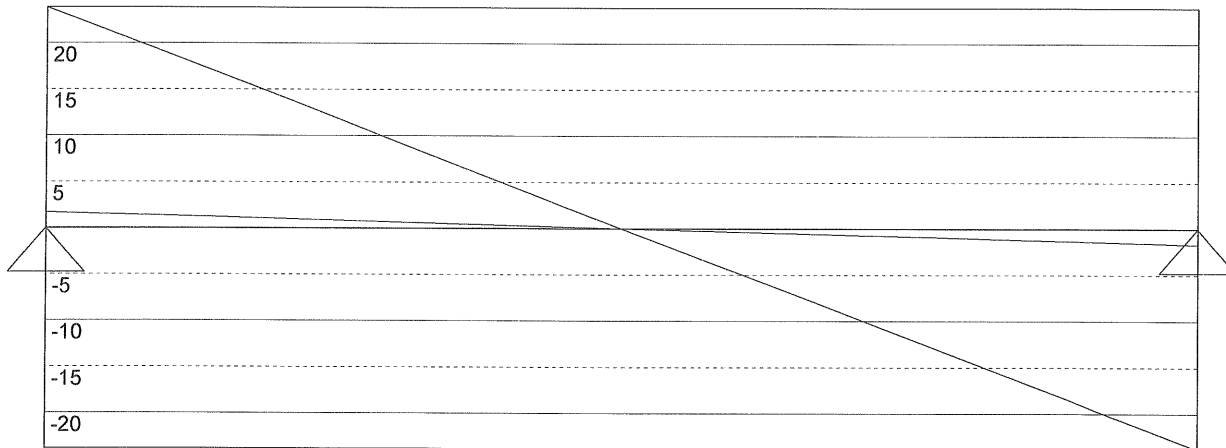

Load factor of dead load= 1 Load factor of imposed load= 1
 Load width 2.6 (m) (by which the loads has been multiplied during calculation)
 Max/Min reactions of beam [kN]
 23,858 23,863
 1,690 1,690

T24 164 x 260 B 2 Cf=1,00 Design method: Allowable stress design
 Increasing factor of the allowable stress 1,02
 Factored Moment/Moment capacity [kNm] 7,755 18,058 43 %
 Factored shear force/shear capacity [kN] 23,858 27,781 86 %

(1) PROFILE

Deflection due to unfactored load (Deflection limit L/240)
 0,9 mm (16 %)

Beam Id: Lot#80 - RB 10

Date 02-09-2019

Structural Engineer:

Licensed to: FINNLAMELLI OY

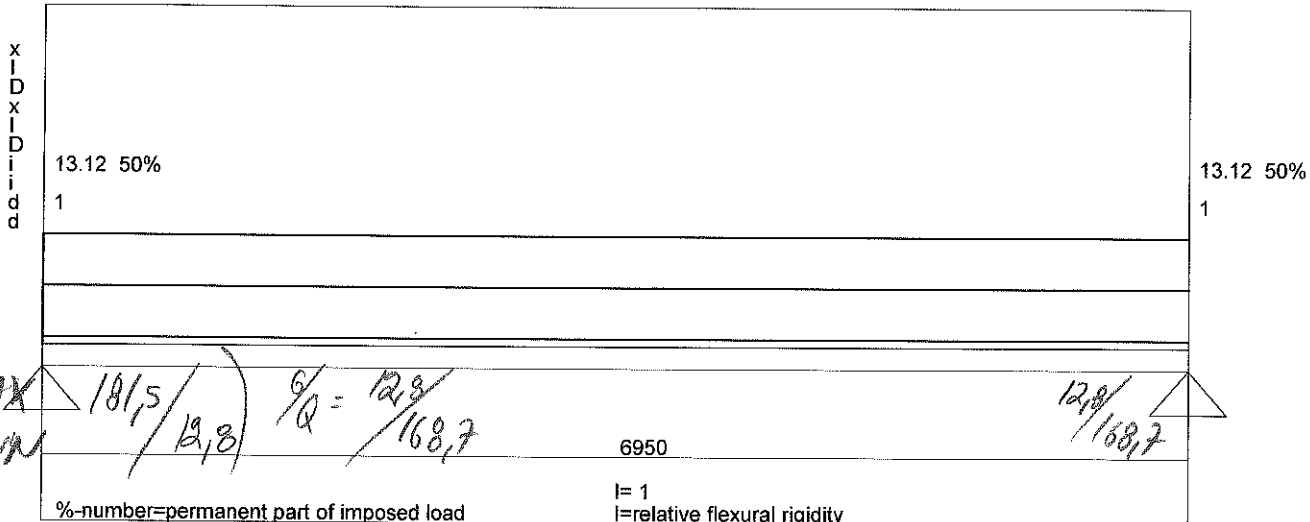

Licensed to: FINNLAMELLI OY



Licensed to: FINNLAMELLI OY

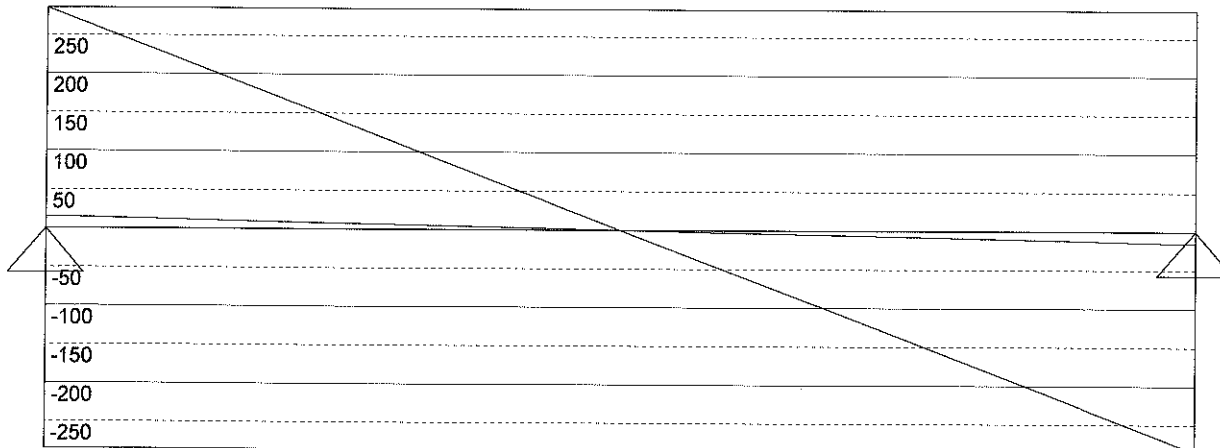

Load factor of dead load = 1.2 / Load factor of imposed load = 1.6
 Load width 3.7 (m) (by which the loads has been multiplied during calculation)
 Max/Min reactions of beam [kN]
 285,277 285,334
 15,426 15,429

HEB 320 (Class of section=1/1) G= 127 I(cm4)=30823 W(cm3)=1930 fy=235
 Factored Moment/Moment capacity [kNm] 495,767 502,900 99 %
 Factored shear force/shear capacity [kN] 285,277 485,604 59 %

HEB 320 = W 12 x 87

Sum inf M+S 0,97 (must be <=1) x= 3475 M=495,77 S=0
 Deflection due to unfactored load (Deflection limit L/240)
 24,6 mm (85 %)
 Attention! Ultimate limit design! Remember the load factors!!

Beam Id: Lot#80 - RB //

Date 02-09-2019

Structural Engineer:

Licensed to: FINNLAMELLI OY

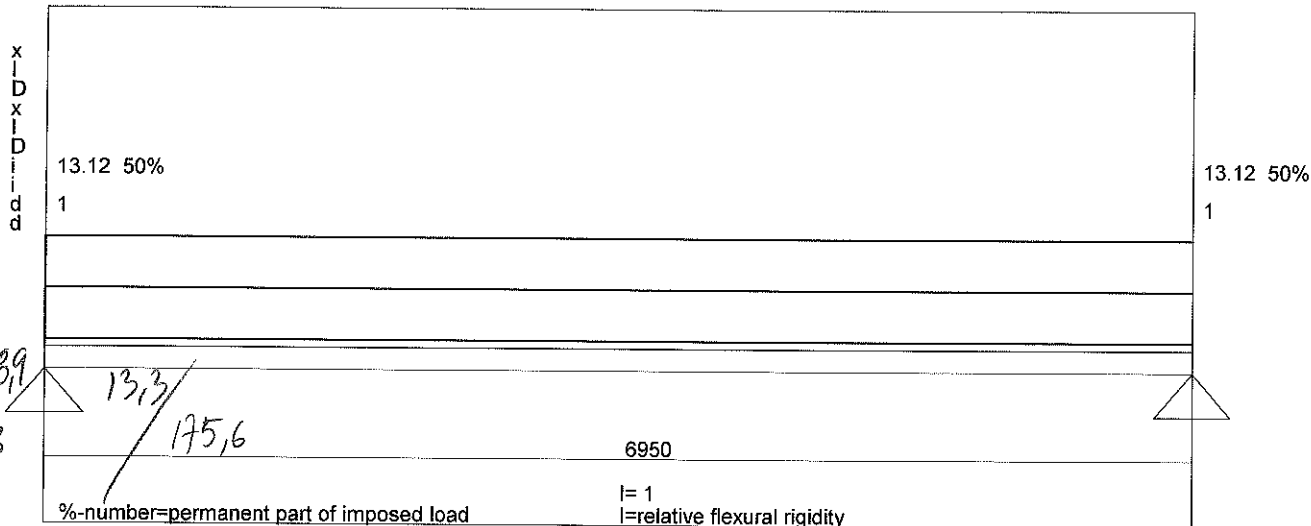

Licensed to: FINNLAMELLI OY

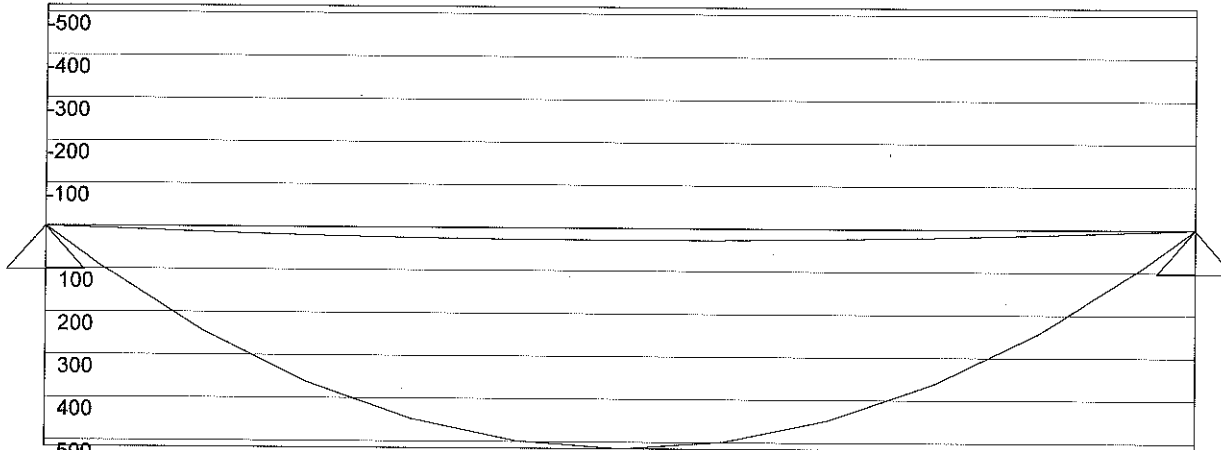

Licensed to: FINNLAMELLI OY

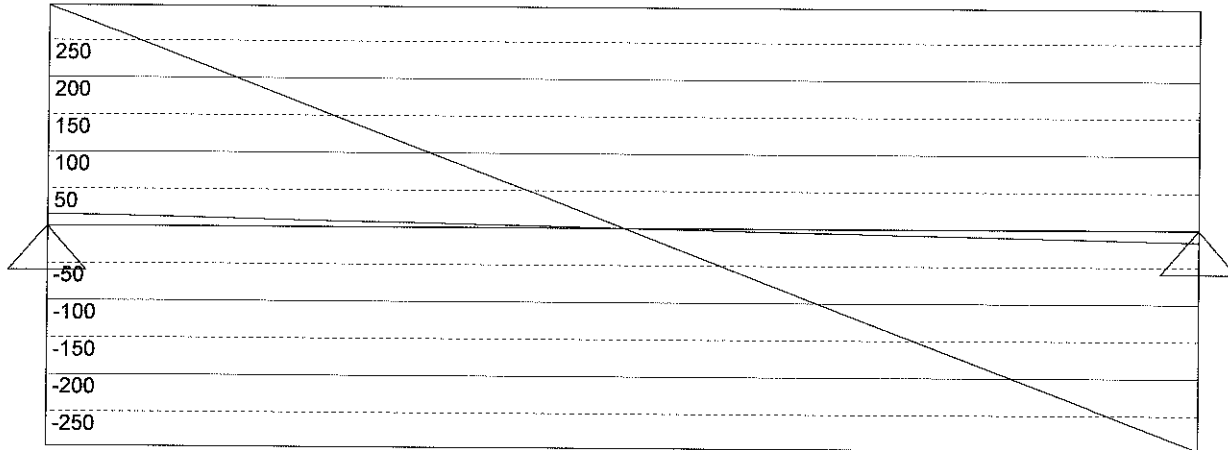

Load factor of dead load= 1.2 Load factor of imposed load= 1.6

Load width 3.85 (m) (by which the loads has been multiplied during calculation)

Max/Min reactions of beam [kN]

296,842 296,901
16,051 16,055

HEB 340 (Class of section=1/1) G= 134 I(cm4)=36656 W(cm3)=2160 fy=235

Factored Moment/Moment capacity [kNm] 515,866 564,000 91 %

Factored shear force/shear capacity [kN] 296,842 538,902 55 %

HEB 340 = W 12x106

Sum infl M+S 0,90 (must be <=1) x= 3475 M=515,87 S=0

Deflection due to unfactored load (Deflection limit L/240)

21,5 mm (74 %)

Attention! Ultimate limit design! Remember the load factors!!

Beam Id: Lot#80 - RB 12

Date 03-09-2019

Structural Engineer:

Licensed to: FINNLAMELLI OY

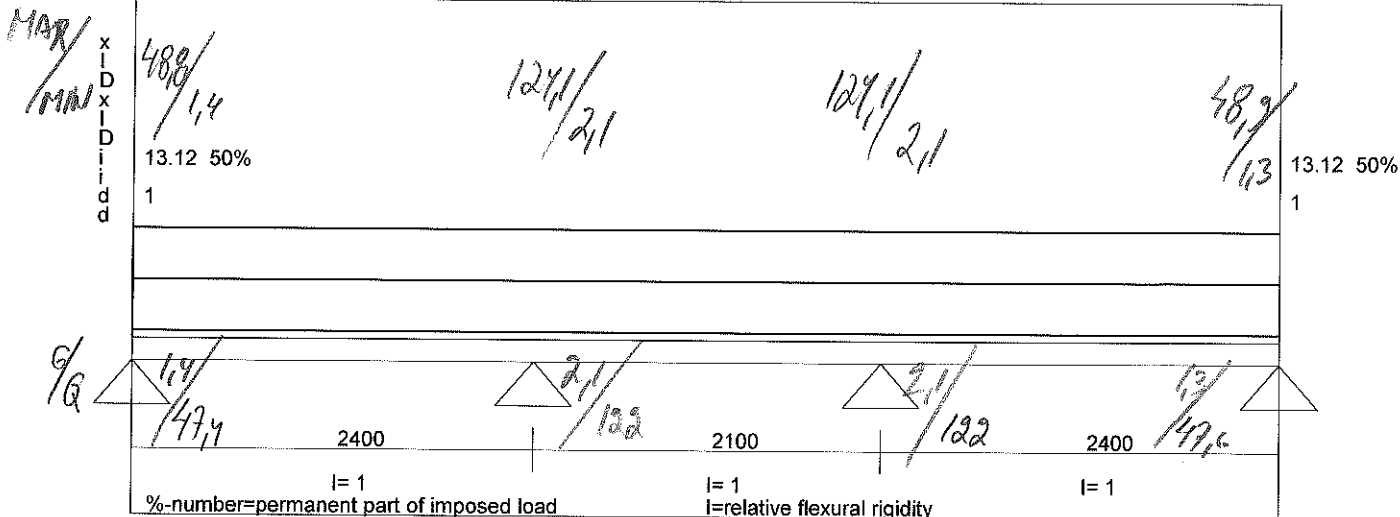

Licensed to: FINNLAMELLI OY

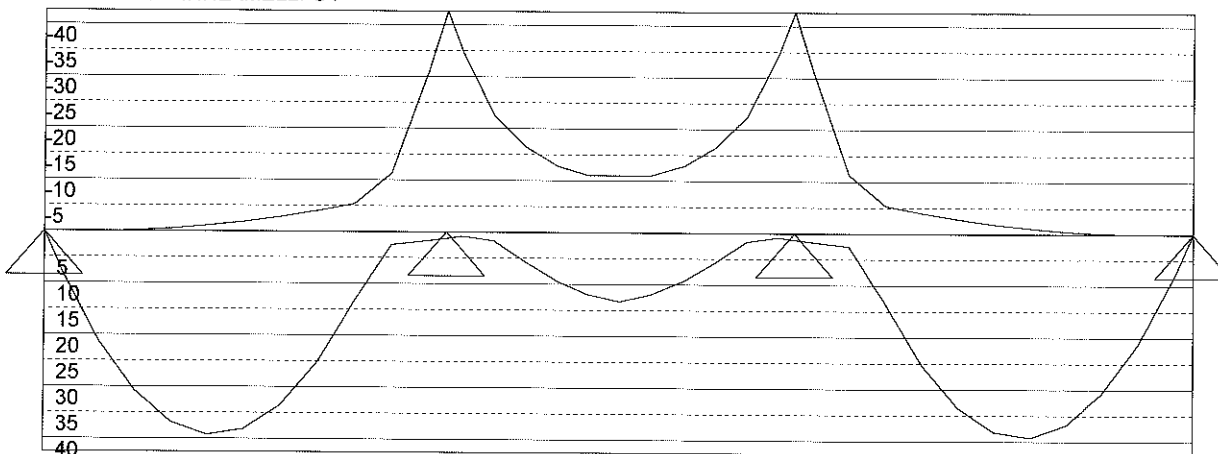

Licensed to: FINNLAMELLI OY

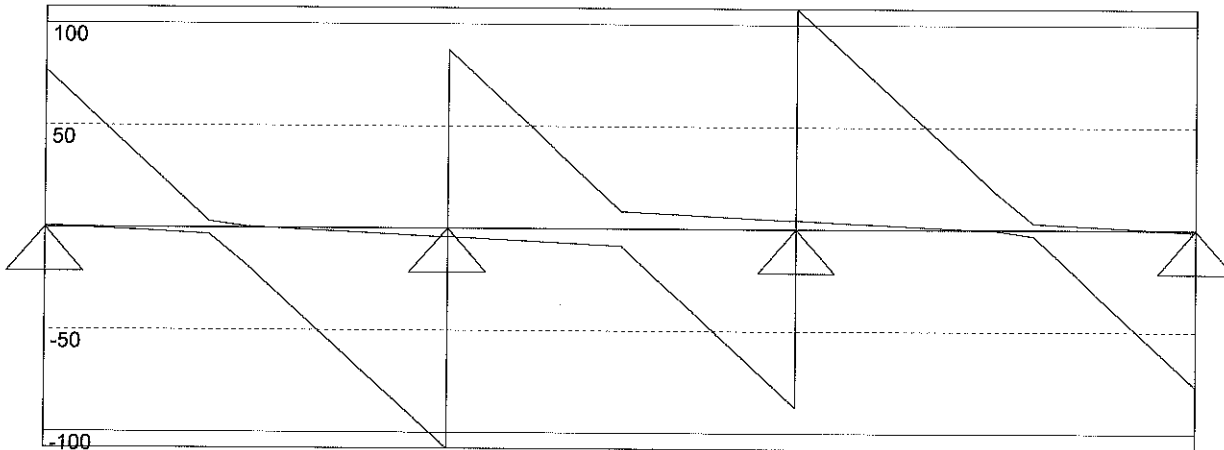

Load factor of dead load = 1.2 Load factor of imposed load = 1.6
 Load width 3.385 (m) (by which the loads has been multiplied during calculation)
 Max/Min reactions of beam [kN]
 76,891 195,236 195,238 76,907
 0,890 0,106 0,107 0,892

HEB 140 (Class of section=1/1) G= 33,7 I(cm4)=1509 W(cm3)=216 fy=235
 Factored Moment/Moment capacity [kNm] 42,569 57,810 74 %
 Factored shear force/shear capacity [kN] 107,871 126,336 85 %

HEB 140 = W6x20

Deflection due to unfactored load (Deflection limit L/240)
 4,2 mm (42 %) 0,9 mm (11 %) 4,2 mm (42 %)
 Attention! Ultimate limit design! Remember the load factors!!

Beam Id: Lot#80 - RB 13

Date 03-09-2019

Structural Engineer:

Licensed to: FINNLAMELLI OY

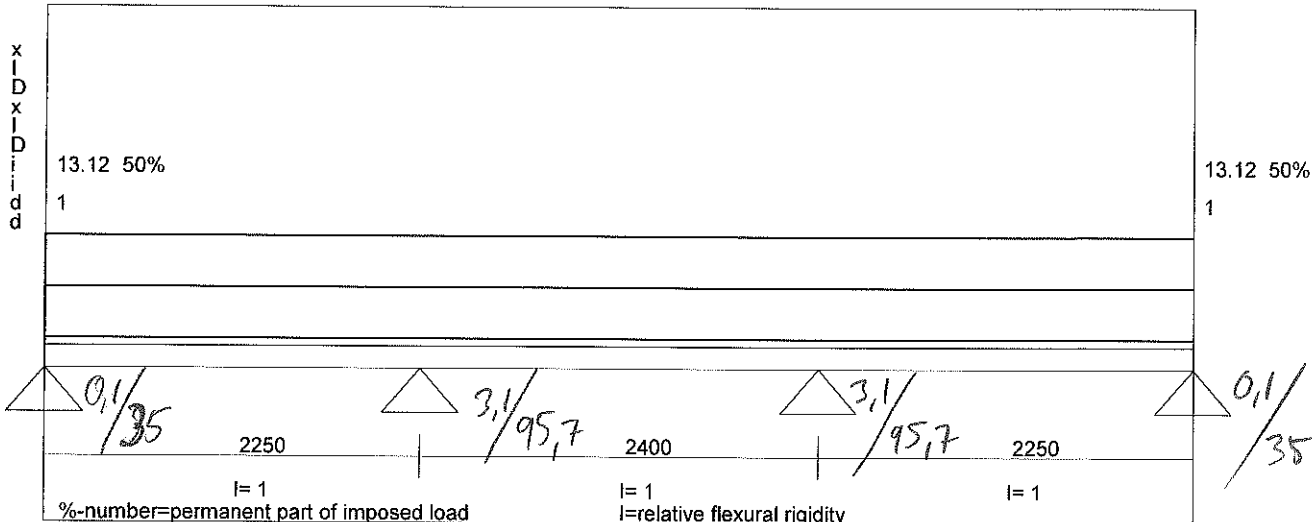

Licensed to: FINNLAMELLI OY

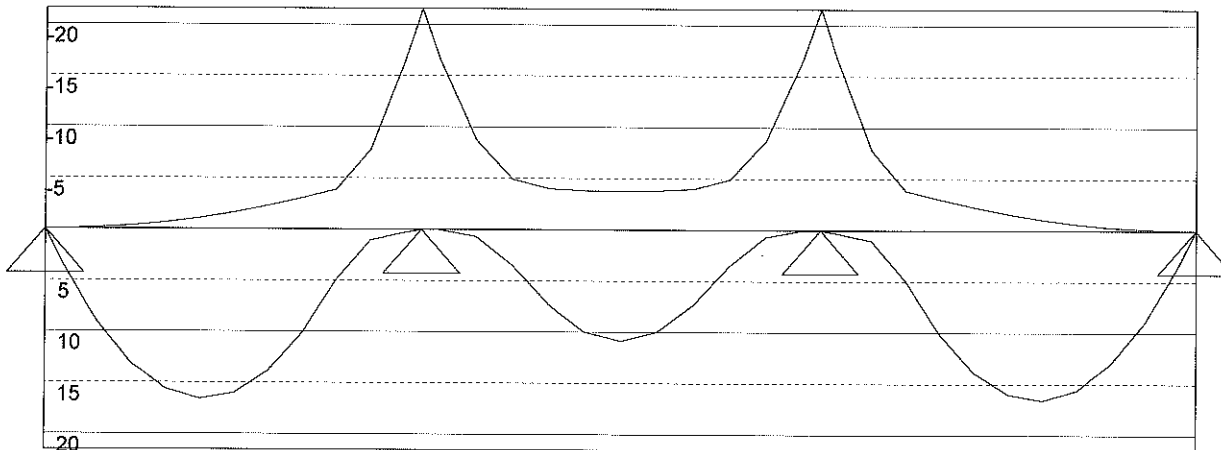

Licensed to: FINNLAMELLI OY

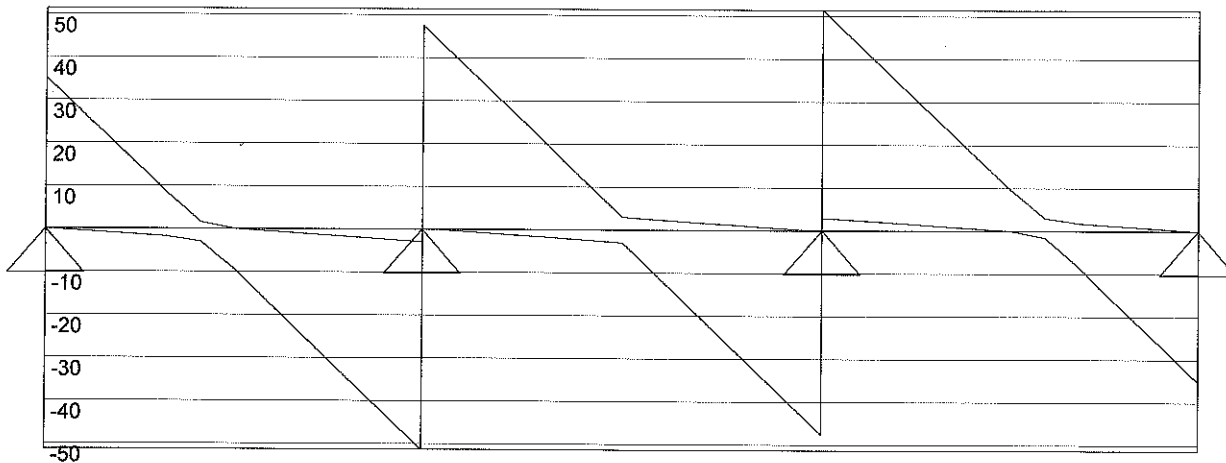

Load factor of dead load= 1 Load factor of imposed load= 1
 Load width 2.63 (m) (by which the loads has been multiplied during calculation)
 Max/Min reactions of beam [kN]
 35,119 98,874 98,882 35,124
 0,052 3,115 3,118 0,053

L40 305 x 215 B 2 Cf=1,00 Design method: Allowable stress design
 Increasing factor of the allowable stress 1,02
 Factored Moment/Moment capacity [kNm] 21,540 35,643 60 %
 Factored shear force/shear capacity [kN] 51,348 51,180 100 %

$$GL (190 + 115) \times \frac{215}{260}$$

Deflection due to unfactored load (Deflection limit L/240)
 3,6 mm (38 %) 2,2 mm (22 %) 3,6 mm (38 %)

$$GL (7\frac{1}{2} + 4\frac{1}{2}) \times 10\frac{1}{4} \text{ OR STEEL ?}$$

Beam Id: Lot#80 - RB 13
 Structural Engineer:

Date 03-09-2019

Licensed to: FINNLAMELLI OY

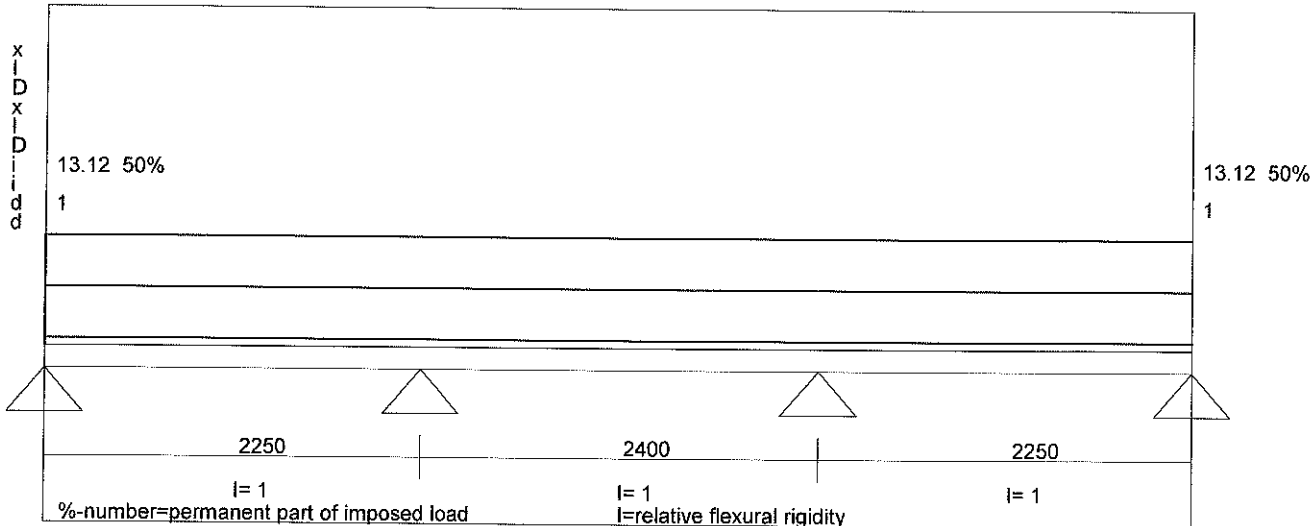

Licensed to: FINNLAMELLI OY

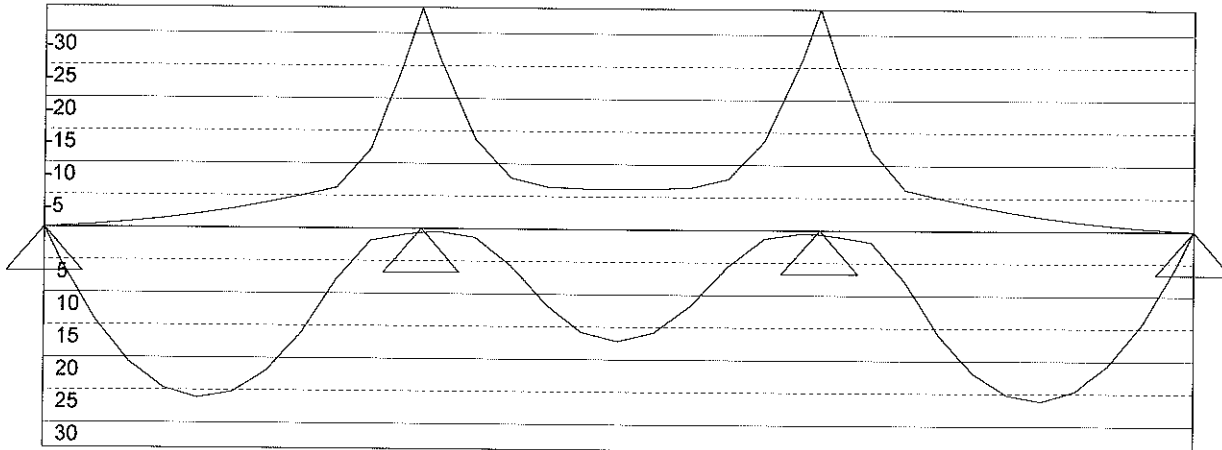

Licensed to: FINNLAMELLI OY

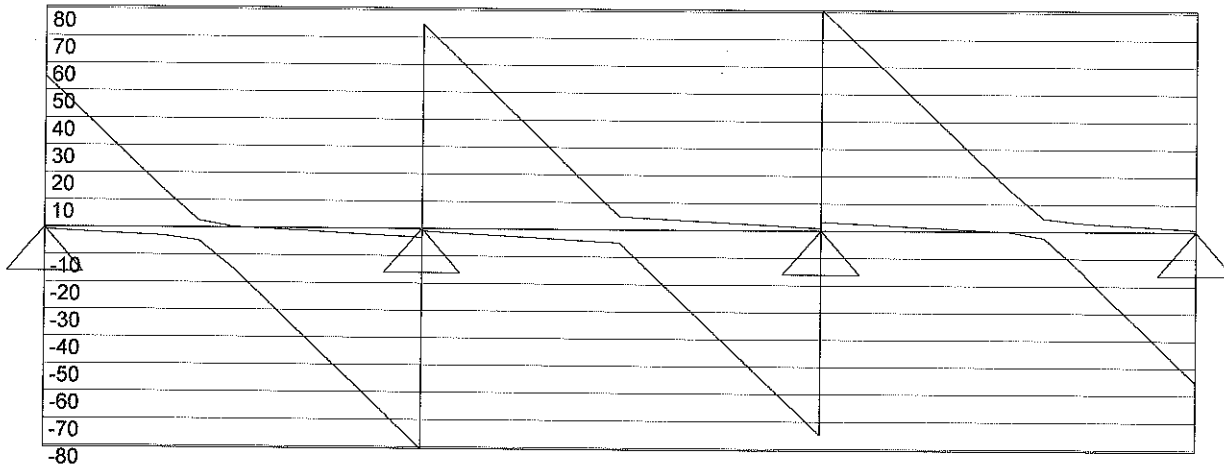

Load factor of dead load= 1.2 Load factor of imposed load= 1.6
 Load width 2.63 (m) (by which the loads has been multiplied during calculation)
 Max/Min reactions of beam [kN]
 55,260 155,501 155,512 55,268
 -0,847 2,285 2,290 -0,846

HEA 140 (Class of section=1/1) G= 24,7 I(cm4)=1033 W(cm3)=155 fy=235
 Factored Moment/Moment capacity [kNm] 33,896 40,749 83 %
 Factored shear force/shear capacity [kN] 80,720 96,585 84 %

w 5 x 19

Sum infl M+S 0,87 (must be <=1) x= 4650 M=33,9 S=80,72
 Deflection due to unfactored load (Deflection limit L/240)
 3,5 mm (38 %) 2,2 mm (22 %) 3,5 mm (38 %)
 Attention! Ultimate limit design! Remember the load factors!!

Beam Id: Lot#80 - RB *14*

Date 03-09-2019

Structural Engineer:

Licensed to: FINNLAMELLI OY

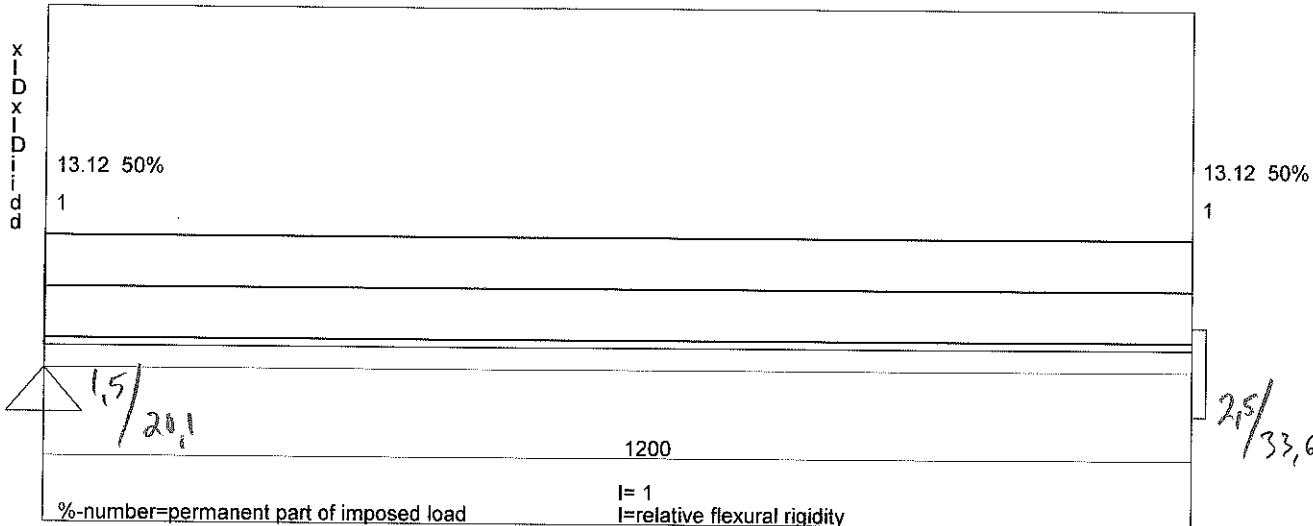

Licensed to: FINNLAMELLI OY

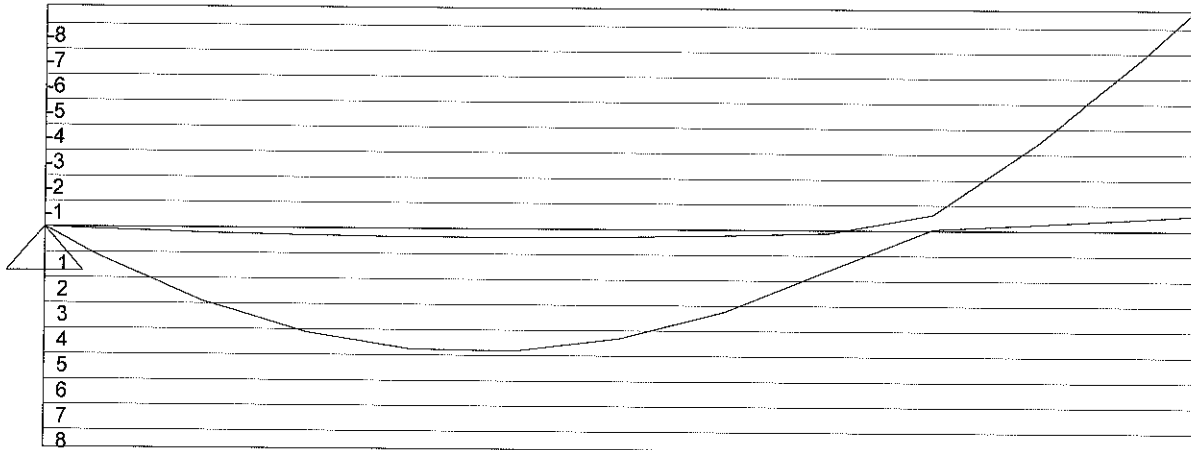

Licensed to: FINNLAMELLI OY

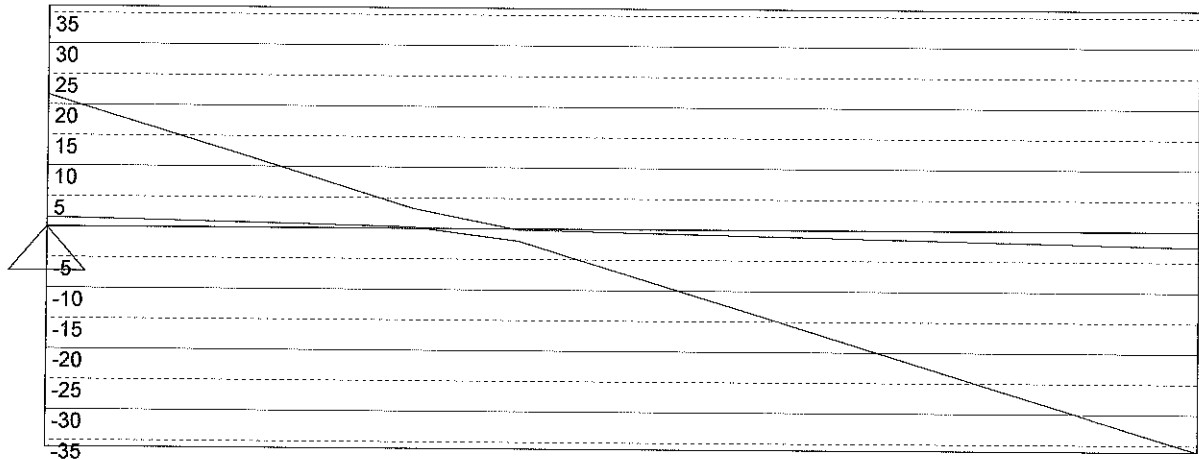

Load factor of dead load= 1 Load factor of imposed load= 1
 Load width 3.41 (m) (by which the loads has been multiplied during calculation)
 Max/Min reactions of beam [kN]
 21,634 36,140
 1,532 2,559

T24 328 x 260 B 2 Cf=1,00 Design method: Allowable stress design
 Increasing factor of the allowable stress 1,02
 Factored Moment/Moment capacity [kNm] 8,700 36,116 24 %
 Factored shear force/shear capacity [kN] 36,134 55,563 65 %

(2) PROFILES

Deflection due to unfactored load (Deflection limit L/240)
 0,2 mm (3 %)

Beam Id: Lot#80 - RB **15**
 Structural Engineer:
 Licensed to: FINNLAMELLI OY

Date 03-09-2019

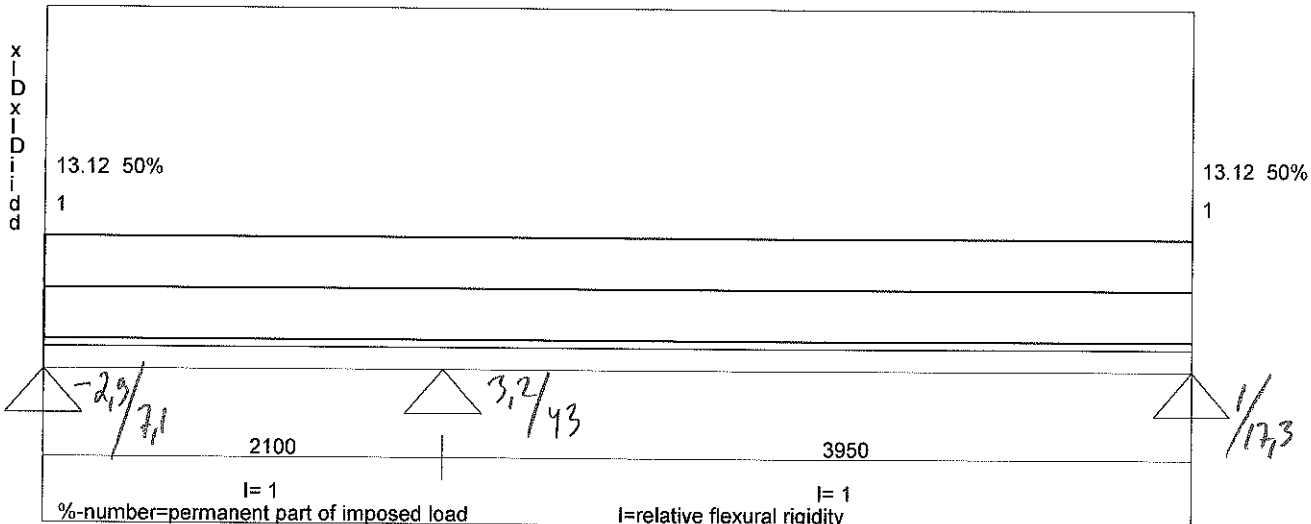

Licensed to: FINNLAMELLI OY

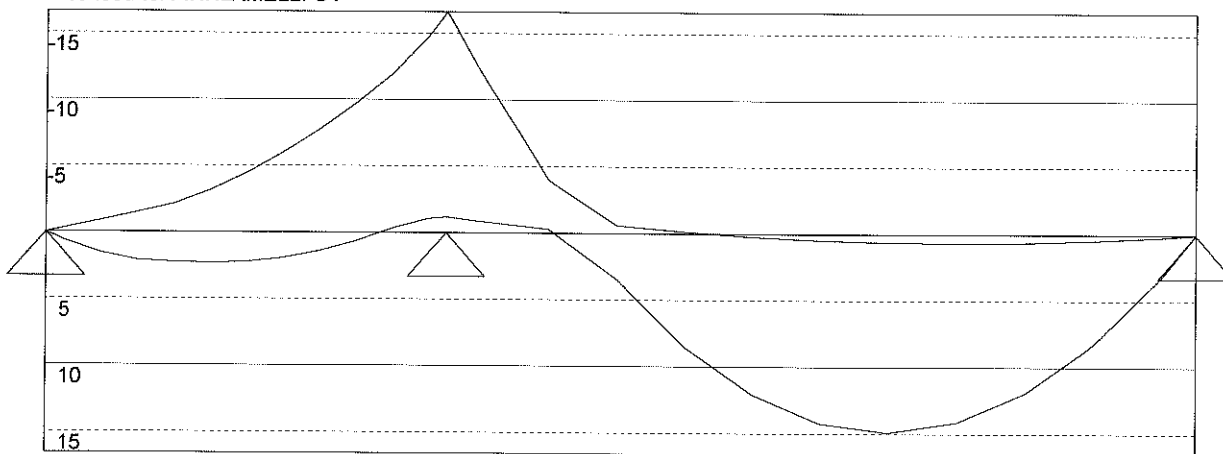

Licensed to: FINNLAMELLI OY

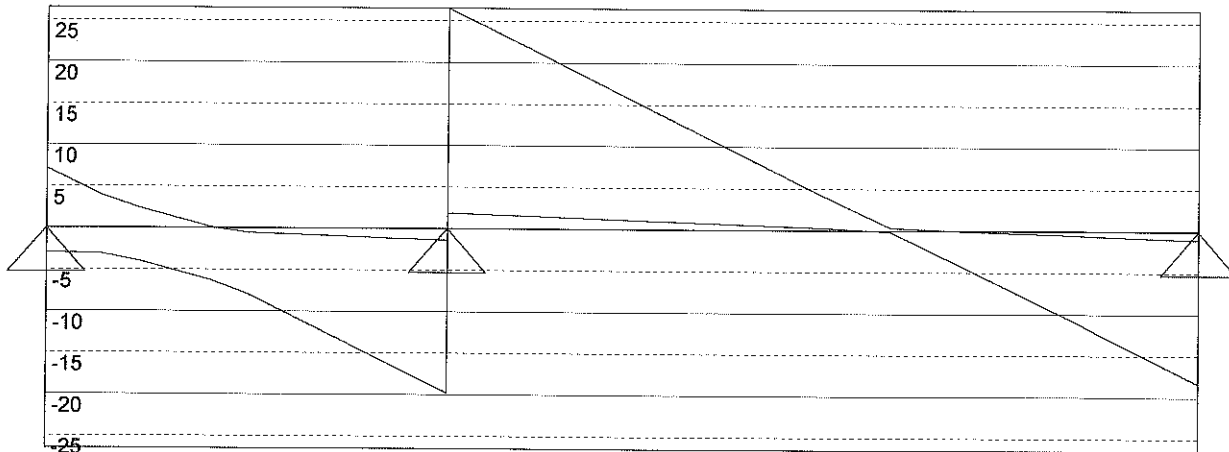

Load factor of dead load= 1 Load factor of imposed load= 1
 Load width .8 (m) (by which the loads has been multiplied during calculation)
 Max/Min reactions of beam [kN]
 7,144 46,277 18,360
 -2,915 3,277 1,027

L40 190 x 215 B 2 Cf=1,00 Design method: Allowable stress design
 Increasing factor of the allowable stress 1,02
 Factored Moment/Moment capacity [kNm] 16,605 22,204 75 %
 Factored shear force/shear capacity [kN] 26,510 31,883 83 %

$\Rightarrow GL (1) 7 \frac{1}{2} \times 10 \frac{1}{4}$

Deflection due to unfactored load (Deflection limit L/240)
 0,7 mm (8 %) 15,5 mm (94 %)

Beam Id: Lot#80 - RB 16

Date 03-09-2019

Structural Engineer:

Licensed to: FINNLAMELLI OY

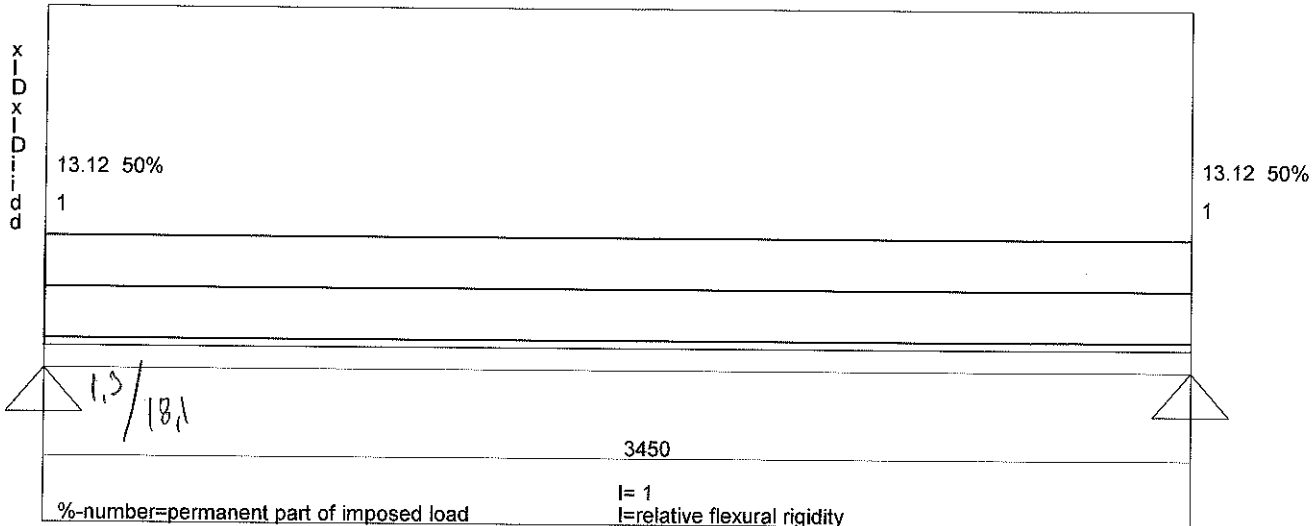

Licensed to: FINNLAMELLI OY

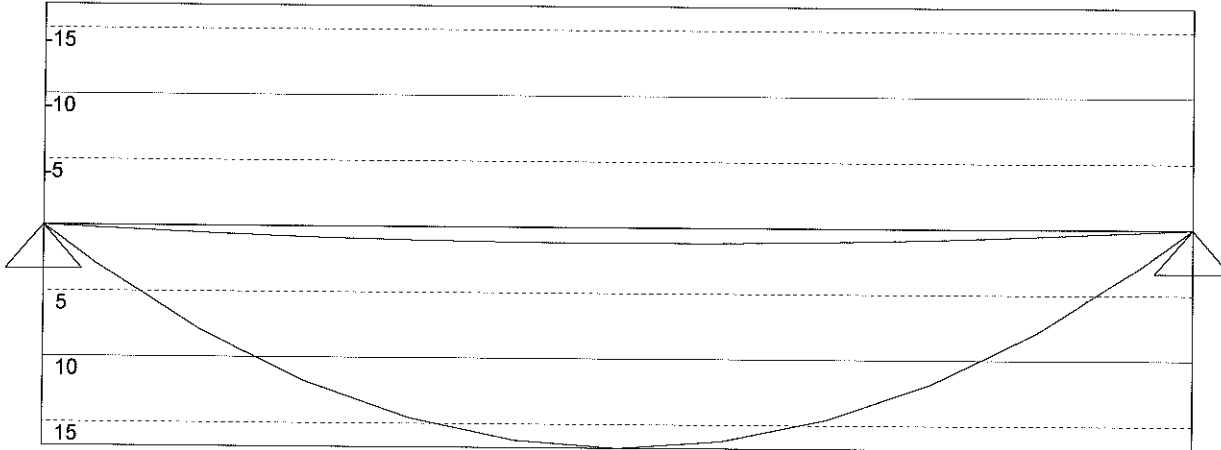

Licensed to: FINNLAMELLI OY

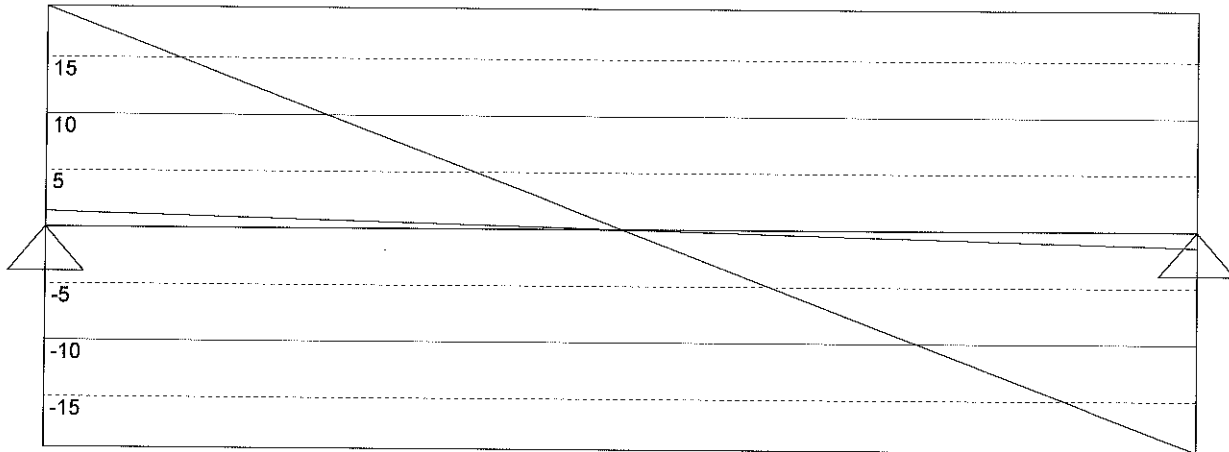

Load factor of dead load= 1 Load factor of imposed load= 1
 Load width .8 (m) (by which the loads has been multiplied during calculation)
 Max/Min reactions of beam [kN]
 19,482 19,486
 1,380 1,380

L40 190 x 260 B 2 Cf=1,00 Design method: Allowable stress design
 Increasing factor of the allowable stress 1,02
 Factored Moment/Moment capacity [kNm] 16,806 32,471 52 %
 Factored shear force/shear capacity [kN] 19,482 38,556 51 %

GL (1) $7\frac{1}{2} \times 10\frac{1}{4}$

Deflection due to unfactored load (Deflection limit L/240)
 8,8 mm (61 %)

Beam Id: Lot#80 - RB

Date 03-09-2019

Structural Engineer:

Licensed to: FINNLAMELLI OY

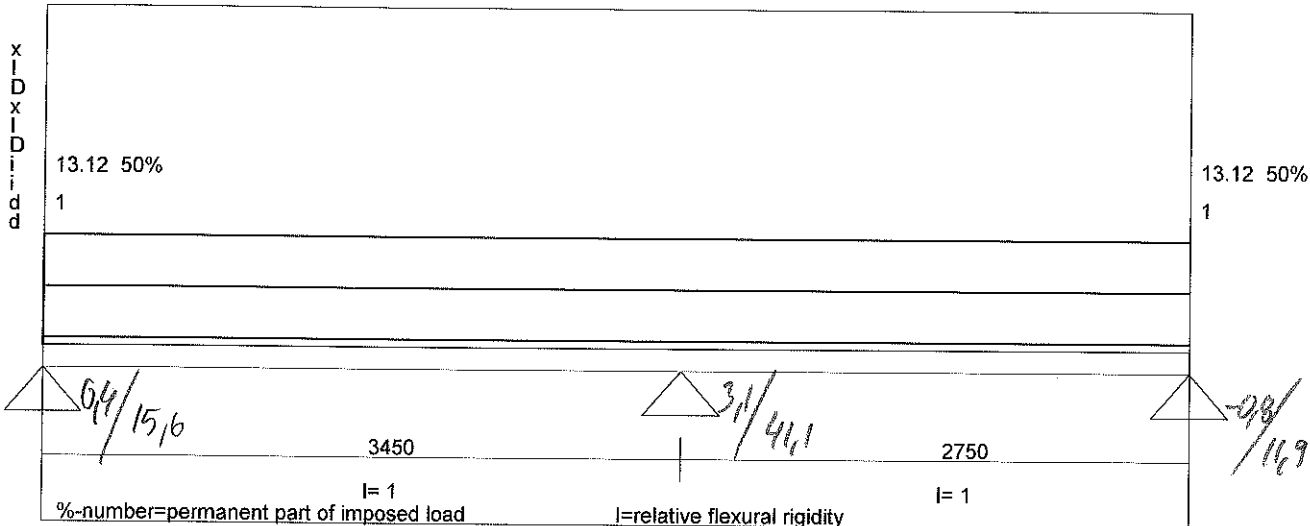

Licensed to: FINNLAMELLI OY

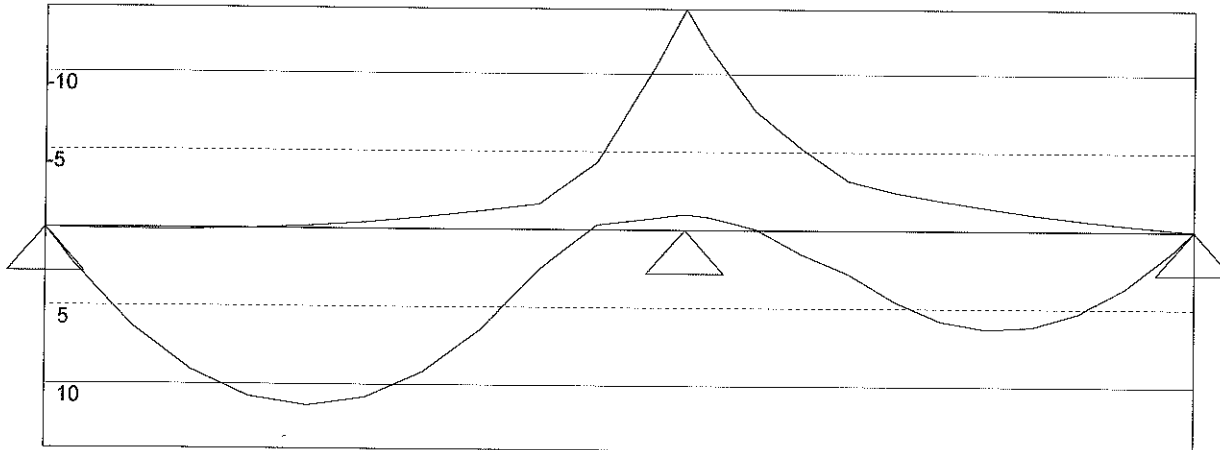

Licensed to: FINNLAMELLI OY

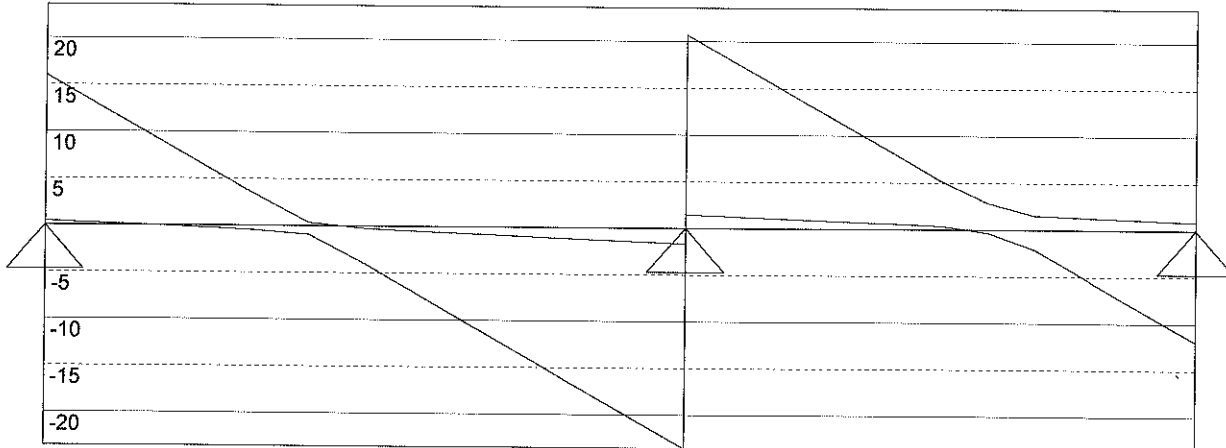

Load factor of dead load= 1 Load factor of imposed load= 1
 Load width .8 (m) (by which the loads has been multiplied during calculation)
 Max/Min reactions of beam [kN]
 16,023 44,253 11,975
 0,449 3,134 -0,850

L40 190 x 215 B 2 Cf=1,00 Design method: Allowable stress design
 Increasing factor of the allowable stress 1,02
 Factored Moment/Moment capacity [kNm] 14,137 22,204 64 %
 Factored shear force/shear capacity [kN] 23,581 31,883 74 %

GL (1) $7\frac{1}{2} \times 10\frac{1}{4}$

Deflection due to unfactored load (Deflection limit L/240)
 9,0 mm (63 %) 2,9 mm (25 %)

Beam Id: Lot#80 - RB *16*
 Structural Engineer: *[Signature]*

Date 03-09-2019

Licensed to: FINNLAMELLI OY

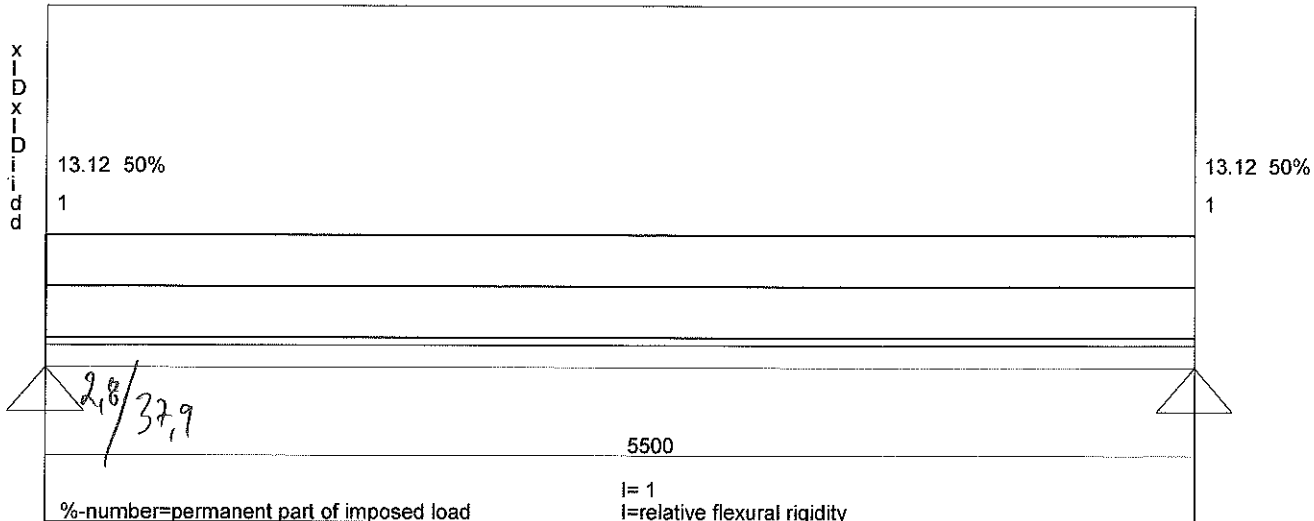

Licensed to: FINNLAMELLI OY



Licensed to: FINNLAMELLI OY

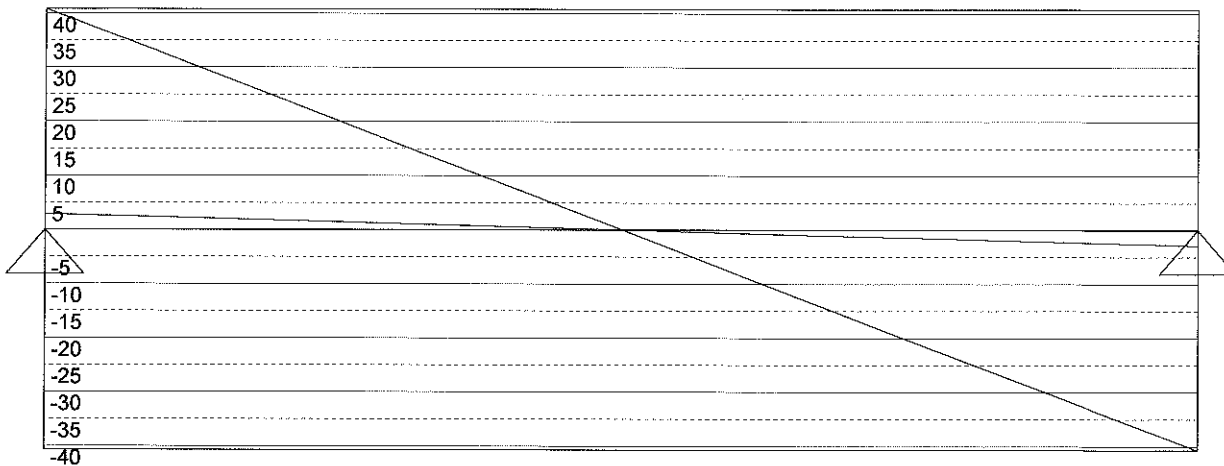

Load factor of dead load= 1 Load factor of imposed load= 1
 Load width 1.05 (m) (by which the loads
 has been multiplied during calculation)
 Max/Min reactions of beam [kN]
 40,763 40,772
 2,887 2,888

L40 140 x 430 B 2 Cf=0,96 Design method: Allowable stress design
 Increasing factor of the allowable stress 1,02
 Factored Moment/Moment capacity [kNm] 56,061 62,876 89 %
 Factored shear force/shear capacity [kN] 40,763 46,985 87 %

(1) GL $5\frac{1}{2} \times 17$

Deflection due to unfactored load (Deflection limit L/240)
 22,5 mm (98 %)

Beam Id: Lot#80 - RB

Date 03-09-2019

Structural Engineer:

Licensed to: FINNLAMELLI OY

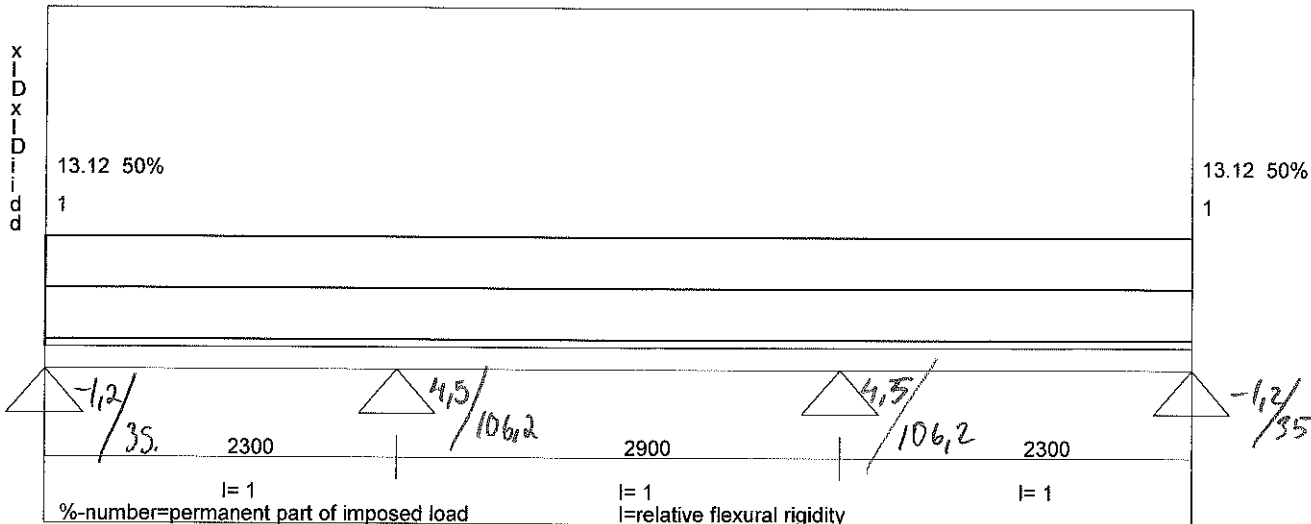

Licensed to: FINNLAMELLI OY

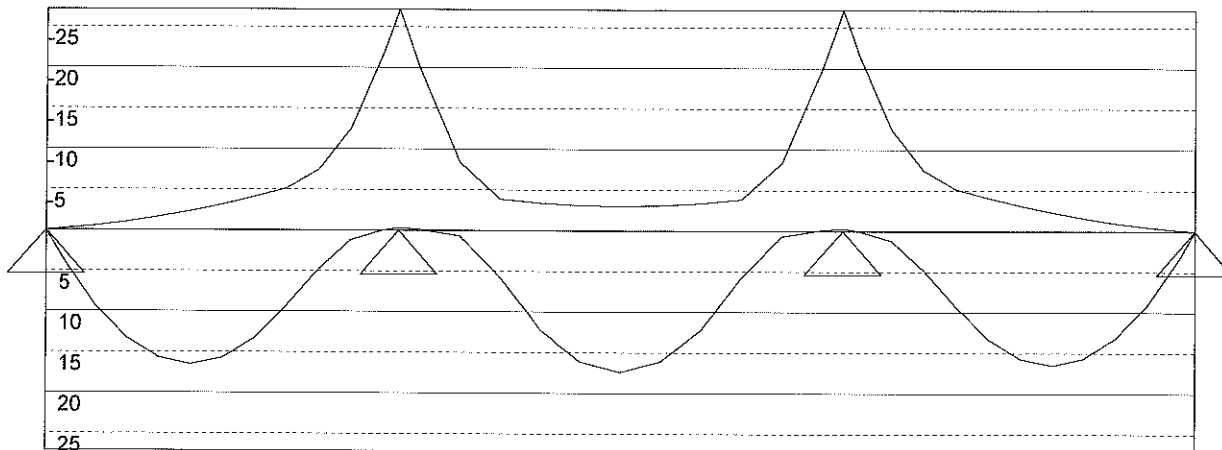

Licensed to: FINNLAMELLI OY

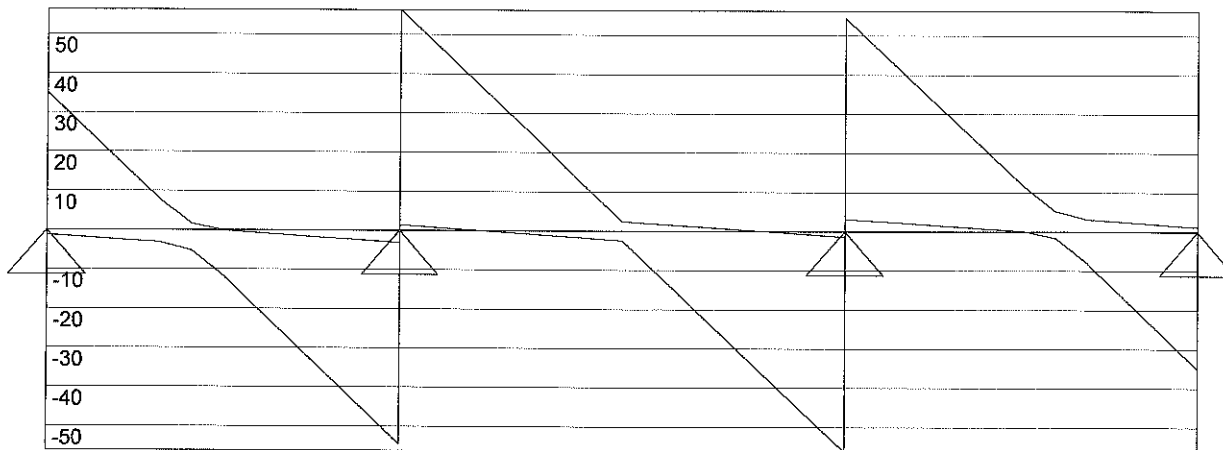

Load factor of dead load= 1 Load factor of imposed load= 1

Load width 2.63 (m) (by which the loads has been multiplied during calculation)

Max/Min reactions of beam [kN]

35,013 110,758 110,758 35,021
-1,217 4,537 4,538 -1,216

L40 190 x 390 B 2 Cf=0,97 Design method: Allowable stress design

Increasing factor of the allowable stress 1,02

Factored Moment/Moment capacity [kNm] 27,135 70,960 38 %

Factored shear force/shear capacity [kN] 56,258 57,834 97 %

(1) $6L \cdot 7\frac{1}{2} \times 15\frac{3}{8}$

Deflection due to unfactored load (Deflection limit L/240)

1,0 mm (10 %) 1,4 mm (12 %) 1,0 mm (10 %)

Beam Id: Lot#80 - RB **20**

Date 03-09-2019

Structural Engineer:

Licensed to: FINNLAMELLI OY

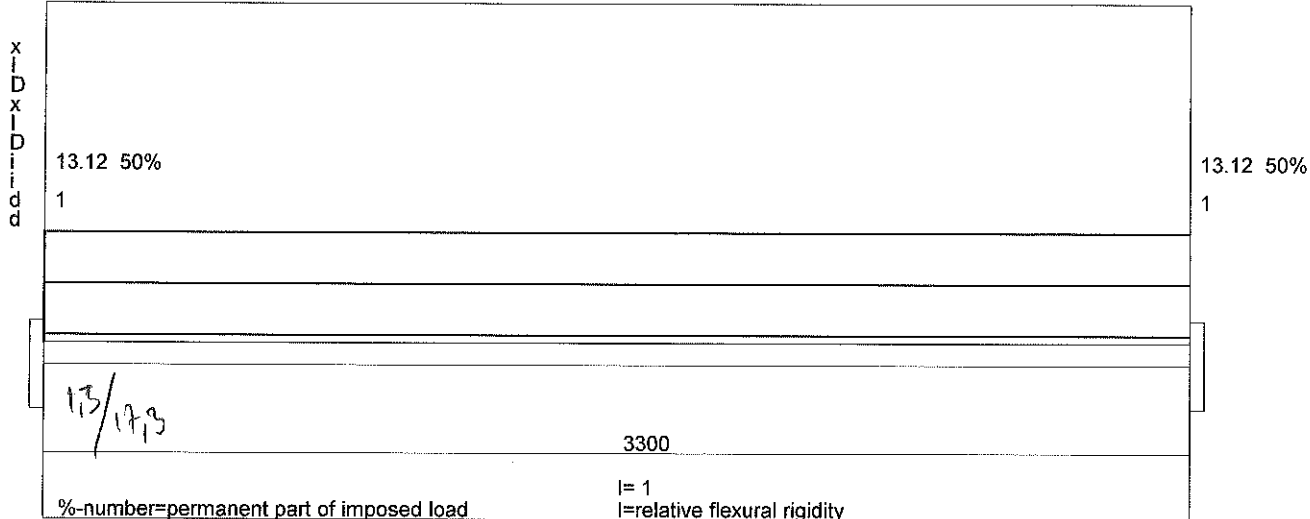

Licensed to: FINNLAMELLI OY

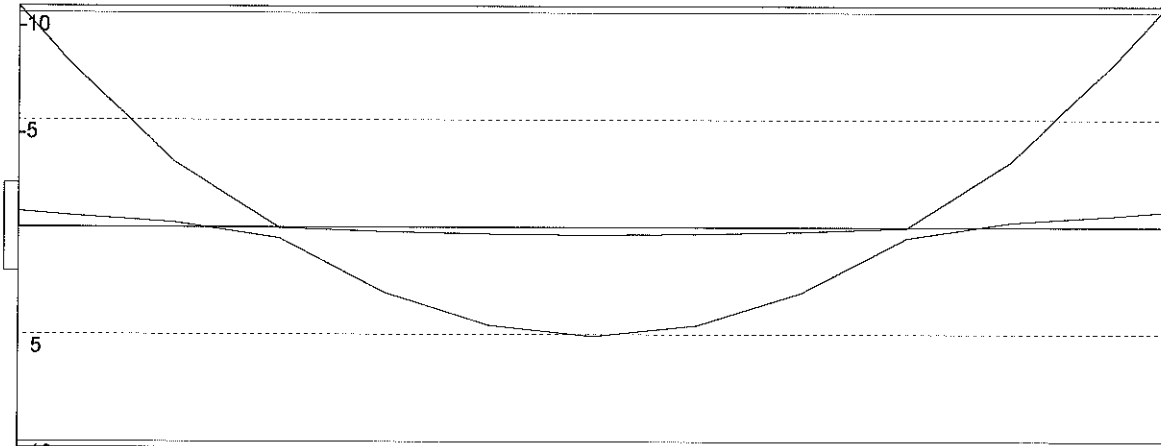

Licensed to: FINNLAMELLI OY

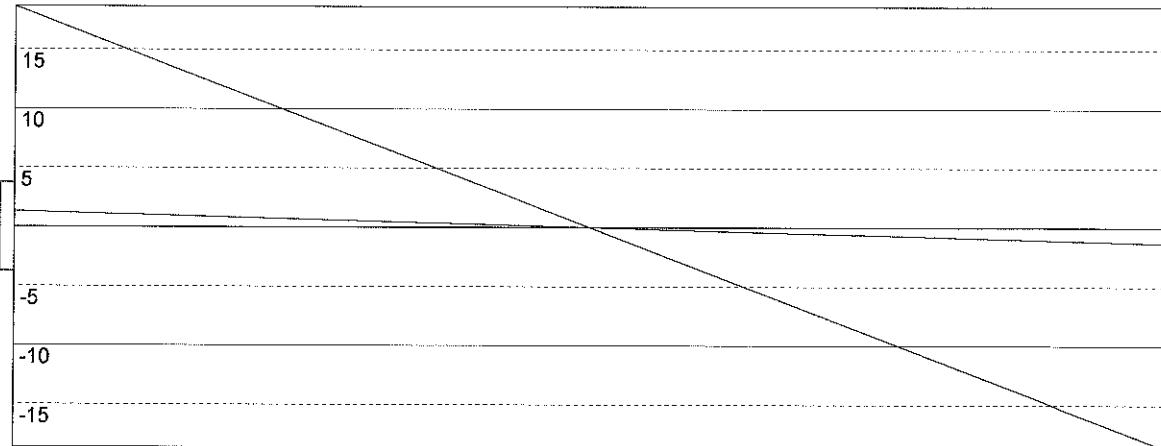

Load factor of dead load= 1 Load factor of imposed load= 1
 Load width .8 (m) (by which the loads has been multiplied during calculation)
 Max/Min reactions of beam [kN]
 18,635 18,638
 1,320 1,320

T24 164 x 260 B 2 Cf=1,00 Design method: Allowable stress design
 Increasing factor of the allowable stress 1,02
 Factored Moment/Moment capacity [kNm] 10,291 18,058 57 %
 Factored shear force/shear capacity [kN] 18,635 27,781 67 %

(1) PROFILE

Deflection due to unfactored load (Deflection limit L/240)
 2,2 mm (16 %)

Beam Id: Lot#80 - RB 21
 Structural Engineer:

Date 04-09-2019

Licensed to: FINNLAMELLI OY

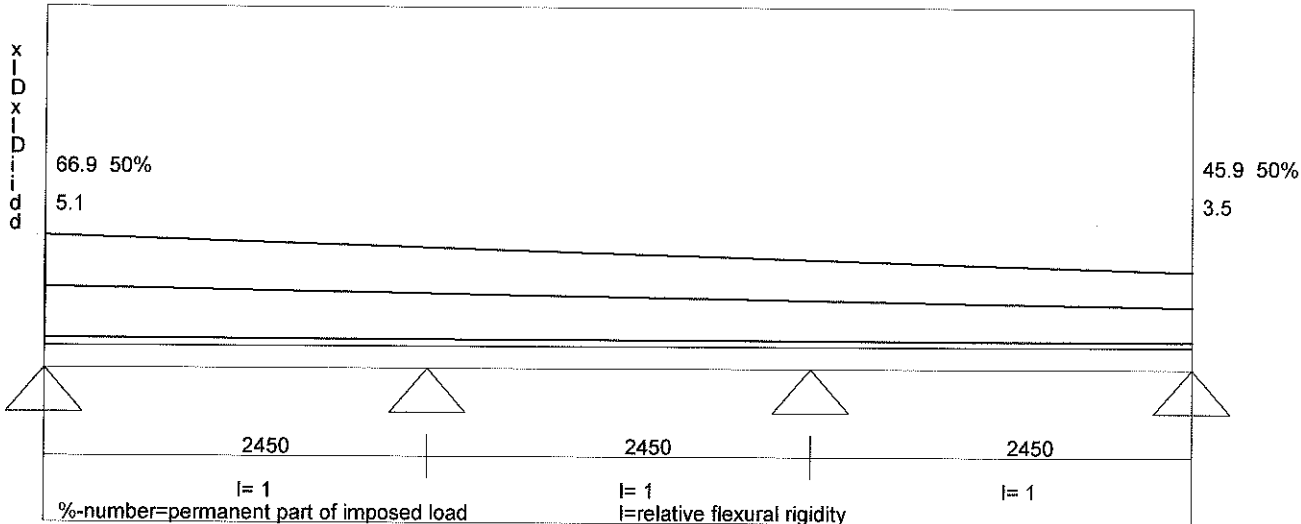

Licensed to: FINNLAMELLI OY

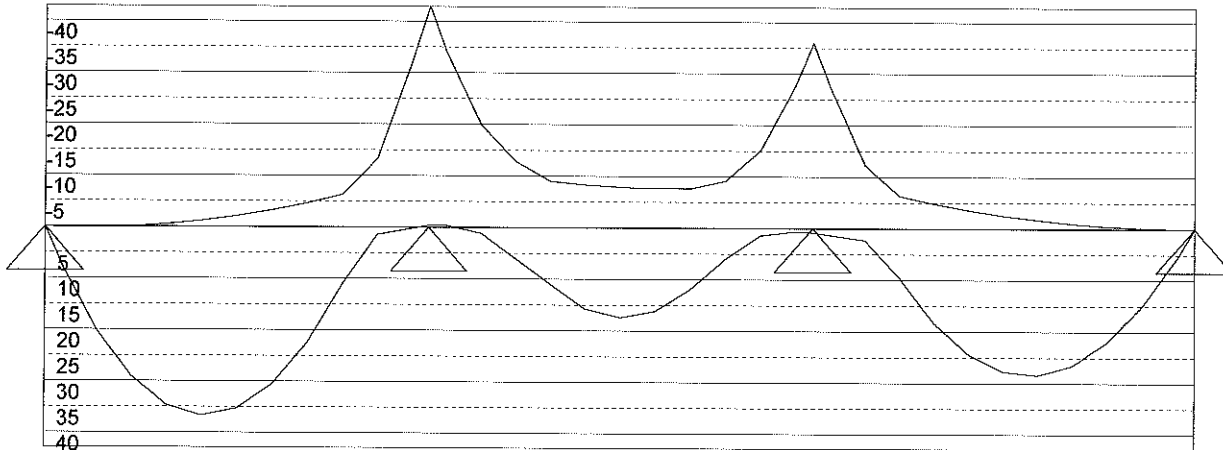

Licensed to: FINNLAMELLI OY

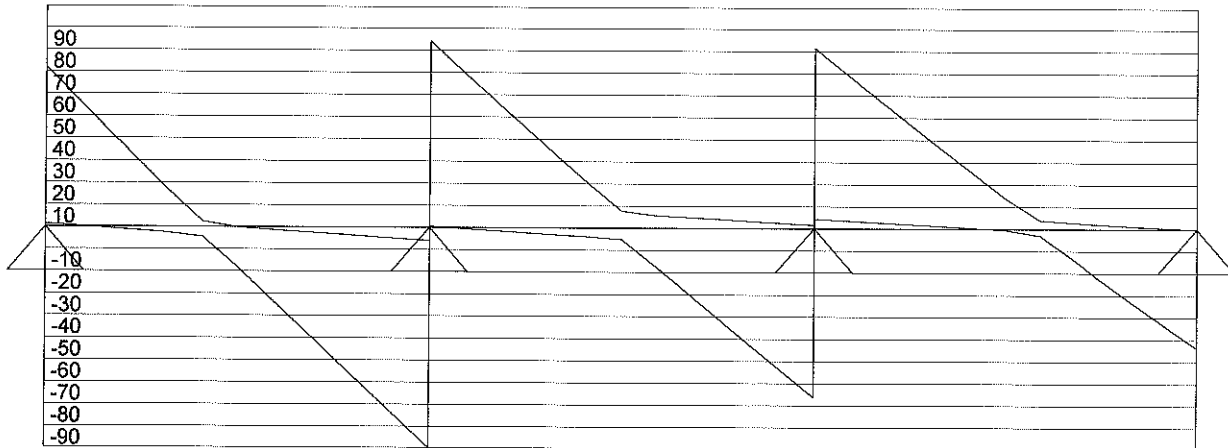

Load factor of dead load= 1 Load factor of imposed load= 1
 Load width 1 (m) (by which the loads has been multiplied during calculation)
 Max/Min reactions of beam [kN]
 72,129 183,569 157,527 53,649
 1,369 6,467 2,843 0,113

L40 305 x 430 B 2 Cf=0,96 Design method: Allowable stress design
 Increasing factor of the allowable stress 1,02
 Factored Moment/Moment capacity [kNm] 42,822 136,980 31 %
 Factored shear force/shear capacity [kN] 99,519 102,361 97 %

$$6L(190 + 115) \times 17$$

Deflection due to unfactored load (Deflection limit L/240)
 1,2 mm (12 %) 0,4 mm (4 %) 0,9 mm (9 %)

Beam Id: Lot#80 - RB 21

Date 03-09-2019

Structural Engineer:

Licensed to: FINNLAMELLI OY

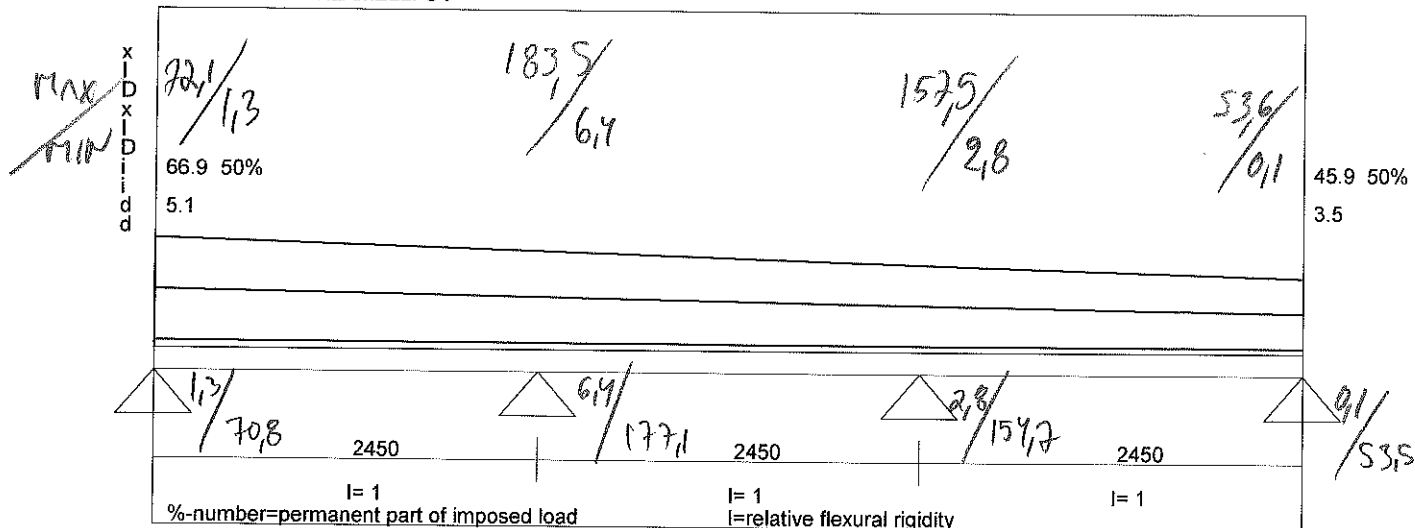

Licensed to: FINNLAMELLI OY

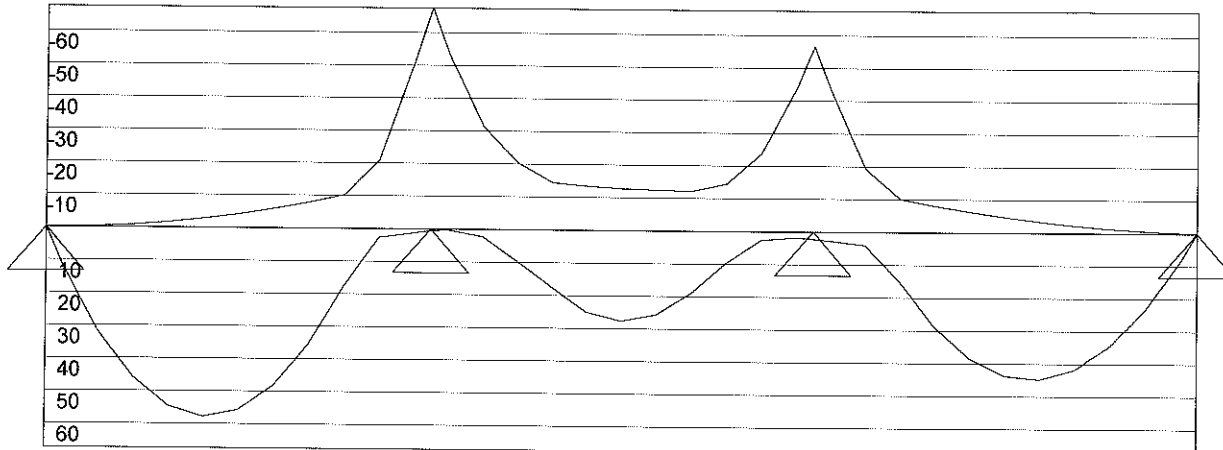

Licensed to: FINNLAMELLI OY

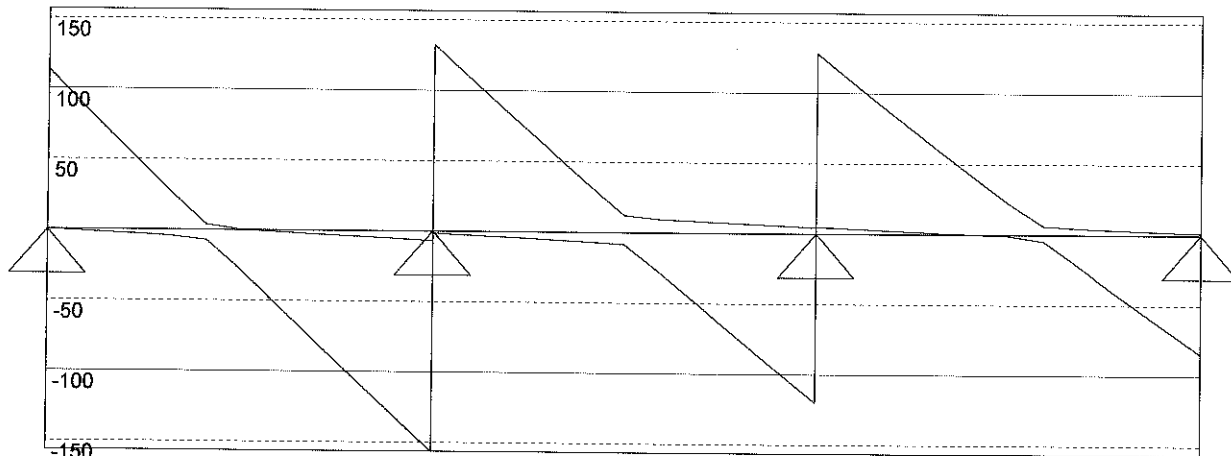

Load factor of dead load= 1.2 Load factor of imposed load= 1.6

Load width 1 (m) (by which the loads has been multiplied during calculation)

Max/Min reactions of beam [kN]
 113,462 288,682 247,800 84,416
 0,246 5,318 0,305 -1,241

HEB160

W8x21 on

HEA 200 (Class of section=1/1) G= 42,3 I(cm4)=3692 W(cm3)=389 fy=235

Factored Moment/Moment capacity [kNm] 67,373 101,050 67 %

Factored shear force/shear capacity [kN] 156,439 164,970 95 %

(W6x25) + GL

Deflection due to unfactored load (Deflection limit L/240)

2,6 mm (26 %) 1,0 mm (9 %) 2,0 mm (20 %)

7 1/2 x 10 1/4

Attention! Ultimate limit design! Remember the load factors!!

Beam Id: Lot#80 - RB entry *22*

Date 25-10-2019

Structural Engineer:

Licensed to: FINNLAMELLI OY

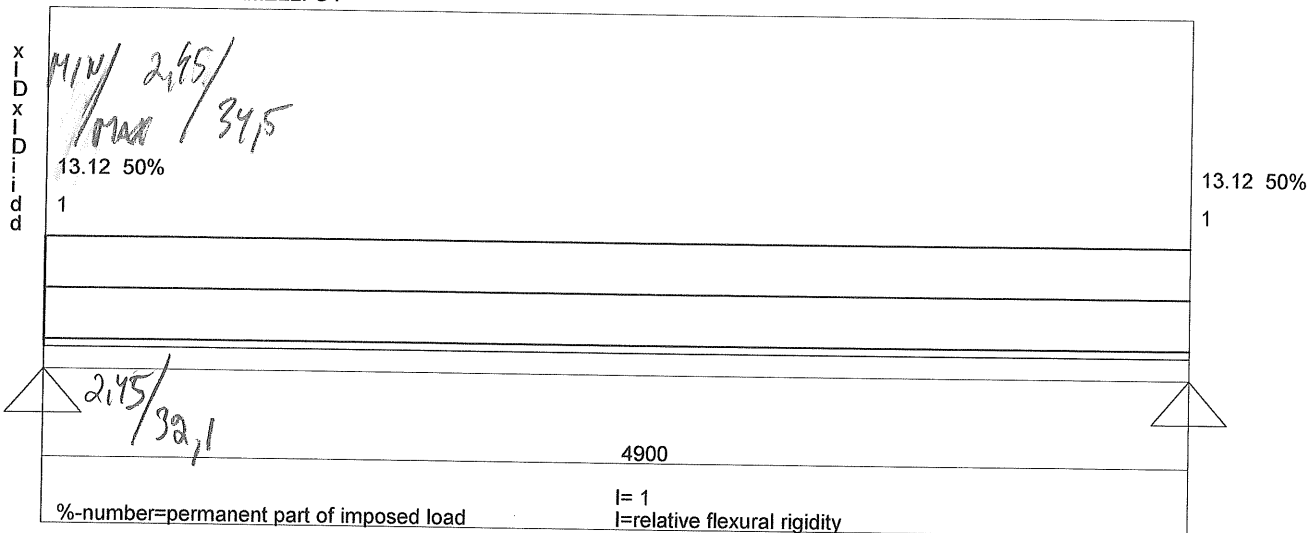

Licensed to: FINNLAMELLI OY

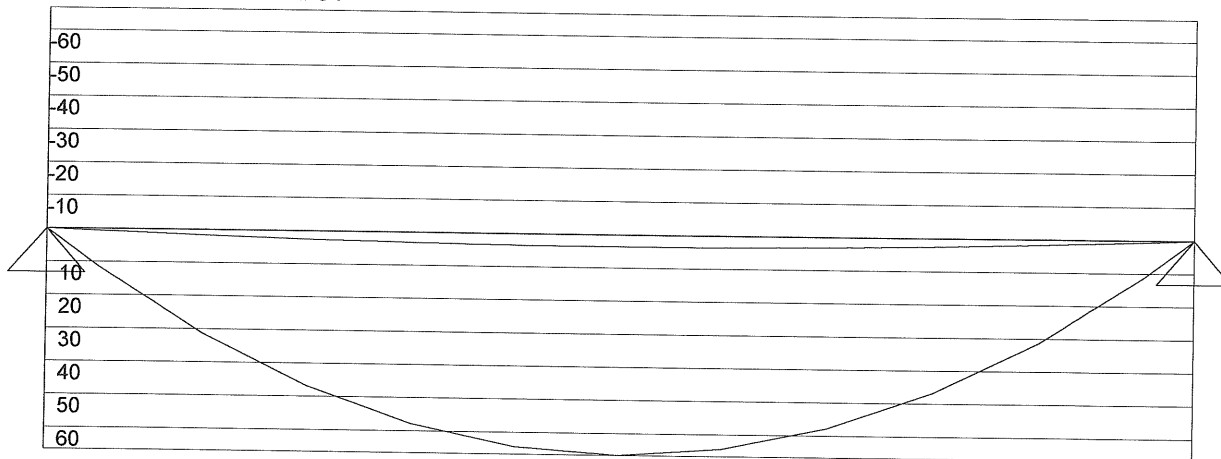

Licensed to: FINNLAMELLI OY

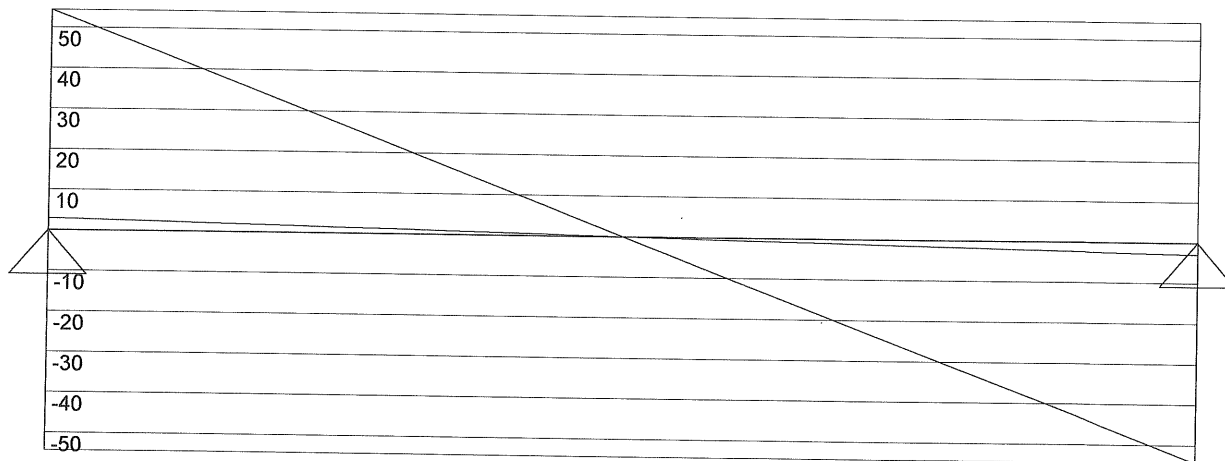

Load factor of dead load= 1.2 Load factor of imposed load= 1.6
 Load width 1 (m) (by which the loads
 has been multiplied during calculation)
 Max/Min reactions of beam [kN]
 54,360 54,370
 2,939 2,940

HEB 160 (Class of section=1/1) G= 42,6 I(cm4)=2492 W(cm3)=311 fy=235
 Factored Moment/Moment capacity [kNm] 66,604 83,190 80 %
 Factored shear force/shear capacity [kN] 54,360 165,816 33 %

W 8 x 21

Deflection due to unfactored load (Deflection limit L/240)
 20,3 mm (100 %)
 Attention! Ultimate limit design! Remember the load factors!!

LOT # 80 ROOF LOADS

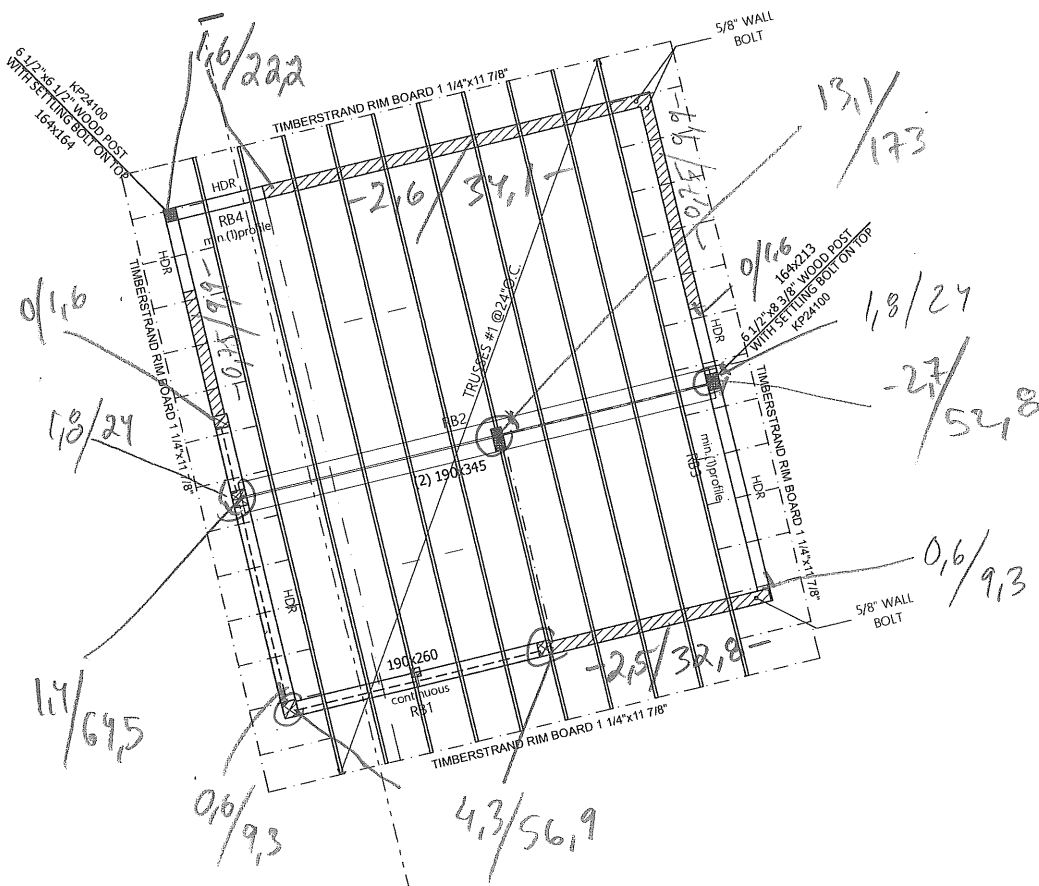

LOT # 80 FLOOR LOADS

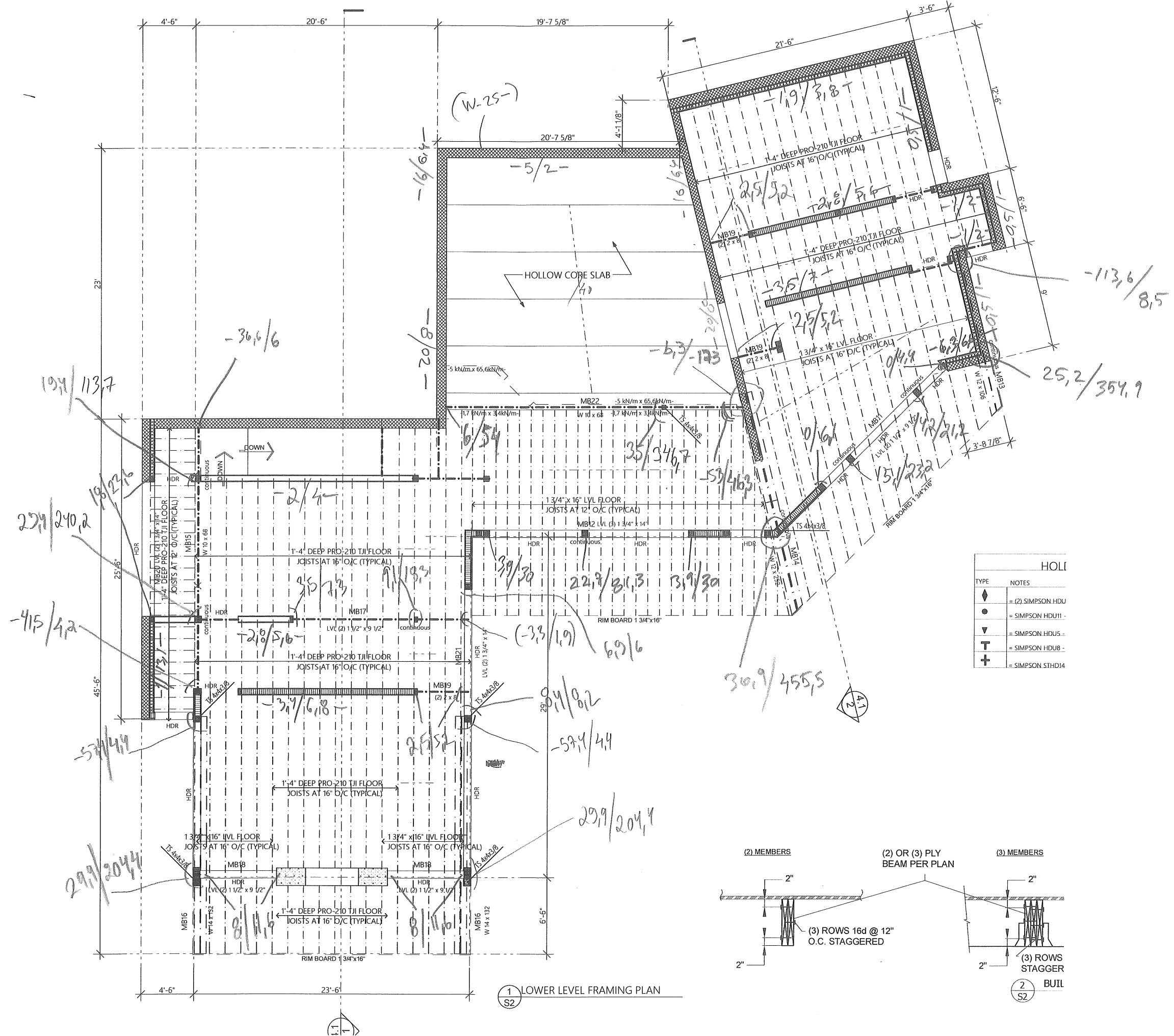

HOLI	
TYPE	NOTES
◆	= (2) SIMPSON HDU
●	= SIMPSON HDU11
▼	= SIMPSON HDUS
⊥	= SIMPSON HDUB
+	= SIMPSON SHD14

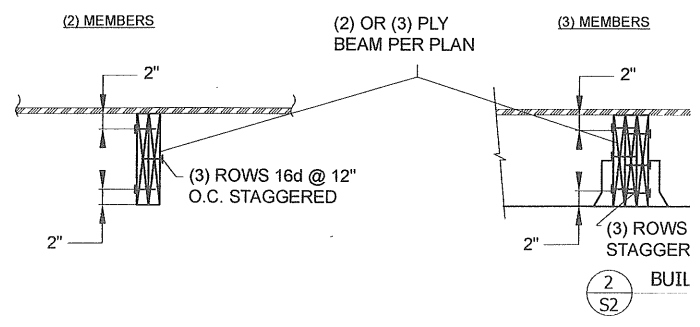

1 LOWER LEVEL FRAMING PLAN
S2

2 BUIL
S2

LOT # 80 FOOTING LOADS

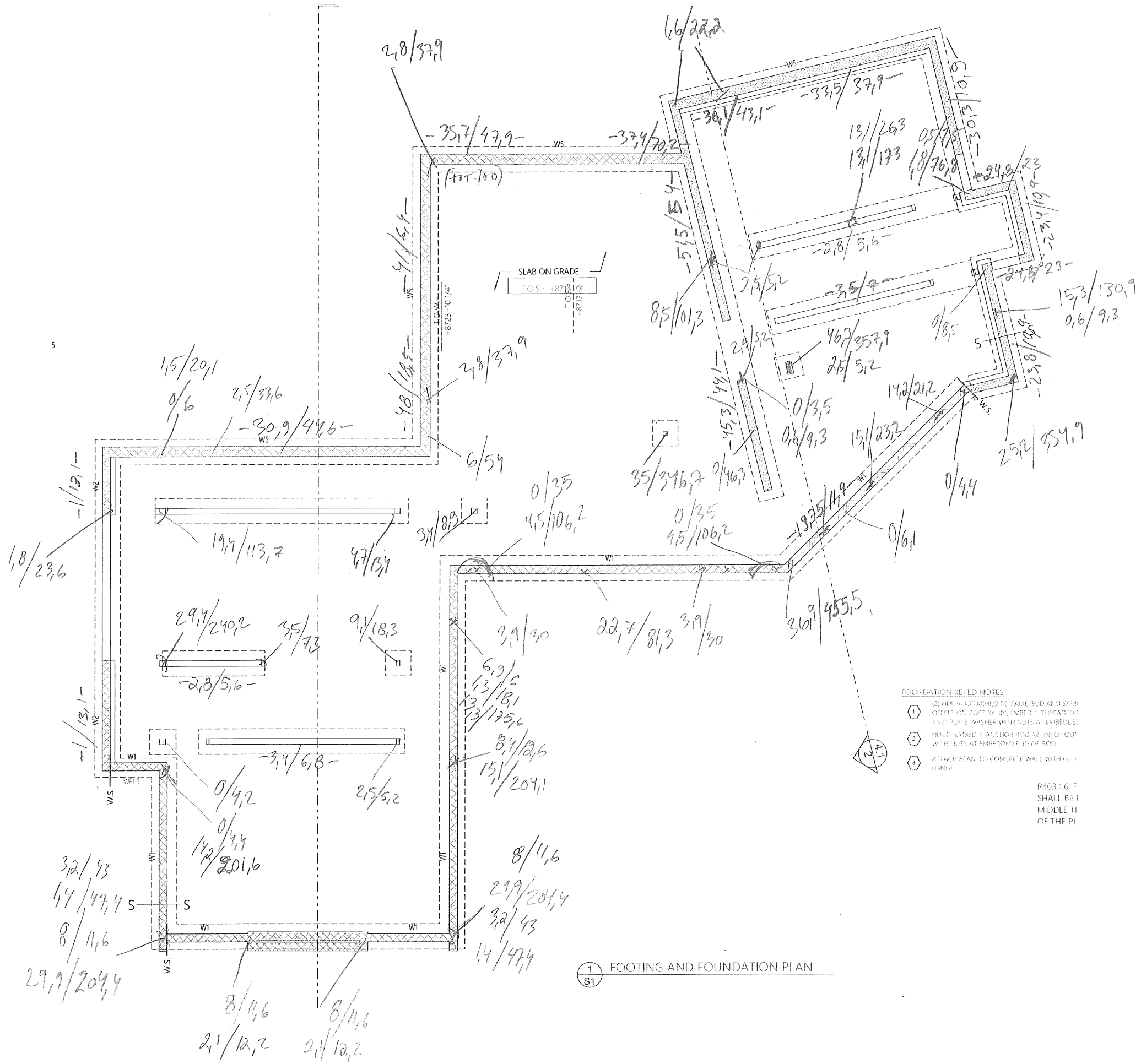

LOT 80 => 2800 PSF
 LOT 86R => 3400 PSF

SOIL PRESSURE

"RED ROCK" ?

LOT 80 / BYRNE

2800 PSF

MAX LOAD TABLE

WF		126.5 kN/m ²
WF 1-8	=	89.2 kN/m
WF 2	=	83.1
WF 2.5	>	103.9
WF 3	=	124.8
WF 3.5	>	145.5
WF 4	=	166.3
WF 4.5	=	187.1
WF 5	=	207.9
WF 6	=	249.6

2800 PSF

MAX LOAD TABLE

		126.5 kN/m ²
F3	=	119.2 kN
F3.5	=	155.5
F4	=	203.6
F4.5	=	257.0
F5	>	317.4
F5.5	=	384.0
F6	=	457.1
F6.5	=	536.3
F8	=	812.6



Project LOT 80 BYRNE Project No. 9085 A
 By: ALEX HAWKINS PE Checked: _____
 Date: 12/20/19 Sheet _____ of _____

GRID 2 COLLECTOR INTO 8W-10

0.7 F_i (ROOF) FROM GLFP = 41.16 K
 2878 SF OF ROOF

TRIB TO COLLECTOR → 512 SF

$$\begin{aligned} \text{COLLECTOR LOAD} &= \frac{512 \text{ SF}}{2878 \text{ SF}} * 41.16 \text{ KIP} * 1.25 \\ &= 9.15 \text{ KIP} \end{aligned}$$

(12.3.3.4)
 ↓

USE CMST 12

$$22' * \frac{12 \text{ IN}}{\text{FT}} \cdot \frac{1}{86 \text{ NAILS}} = 3.07 \frac{\text{IN}}{\text{NAIL}}$$

FILL ROUND HOLES ONLY W/ 10d NAILS
 USE 3X6 BLOCKING

CANTILEVERED DIAPHRAGM

CONFORMS
 TO 4.2.7.1

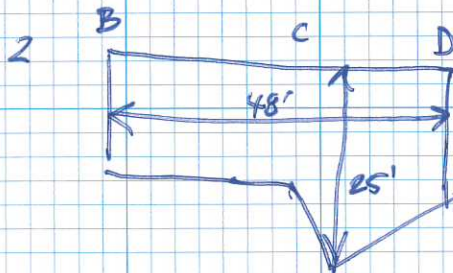

$$\frac{L}{W} = \frac{25}{48} = 0.52 < 0.667$$

CONFORMS
 TO 4.2.7.1

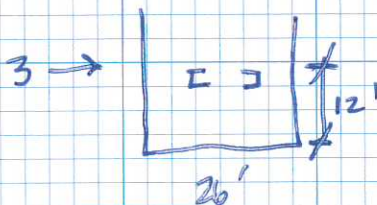

$$\frac{L}{W} = \frac{12'}{26'} = 0.46 < 0.667$$