

(This SWPPP Template is for the **Common Plan** Permit Only, and
does **NOT** address SWPPP requirements found in the CGP.)

Common Plan SWPPP for LOT 23 CAMERON VILLAGE

4077 W 2375 S

WEBER COUNTY, UT 84401

MAC BUILDERS

735 W 2400 S

SYRACUSE, UT 84075

MIKE ALVORD

735 W 2400 S

SYRACUSE, UT 84075

Date

OCTOBER 30, 2019



1. Project Information

Project Name: LOT 23 CAMERON VILLAGE

Address: 4077 WEST 2375 SOUTH

City: WEBER COUNTY

State: UT

Zip: 84401

Latitude: 41.223975

Longitude: -112.0077997

UPDES Permit Tracking Number:

Owner: MAC BUILDERS

Contact Person: MIKE ALVORD

Address: 735 W 2400 S

City: SYRACUSE

State: UT

Zip: 84075

Telephone Number: 801-773-4439

Email Address: office@macbuildersutah.com

General Contractor: MIKE ALVORD

Contact Person:

Address: 735 W 2400 S

City: SYRACUSE

State: UT

Zip: 84075

Telephone Number: 801-645-2300

Email Address: office@macbuildersutah.com

Answering "yes" to the question below means the project is not eligible for this permit.

Is the project in Indian Country?

Yes No

Answering "no" to the question below means the project is not eligible for this permit.

Is the project a residential building on a single lot and disturbing one acre or less?

Yes No

2. Pollution Sources/Best Management Practices

Answer yes or no whether the following features are located at your site. If yes, select the BMP(s) that will be used to protect each feature. If no, continue to the next question. Attach necessary illustrated details for proper installation in Appendix G, and show locations of all controls on Site Map in Appendix A.

- 2.1 Is there a SWPPP sign on site?** (see permit part 1.10) Yes Required
- The sign must include the UPDES tracking number, the owner or general contractor name, phone number and email, and if the SWPPP is on-line, instructions on how to view it. The size requirement is to be readable from a publicly accessible point.*
- 2.2 Will there be construction dewatering on the site?** (see permit part 2.7) Yes No
- BMP(s):** Dewatering of the construction area is needed and a separate dewatering permit has been obtained to treat and discharge water. *Construction Dewatering (if discharged offsite) must be covered by UPDES Permit UTG070000.*
- Water from the dewatering of the construction area will be infiltrated on site.
- 2.3 Will there be non-storm water discharges on the site?** (see permit part 1.3) Yes No
- Allowable discharges include: Flushing of drinking water or irrigation water (not including wash or cleaning waters), water used for dust control, spring water or groundwater not exposed to construction activities, water from emergency fire-fighting activities, and water from foot drains not exposed to construction activities. (see permit part 2.4.5 & 2.9).*
- Please list all anticipated non-storm water discharges:** [Click here to enter text.](#)
- What will you do to manage the non-storm water discharges?** *Please list direct discharges, contained*

non-storm water discharges, and discharges that are treated separately.

- BMP(s):** All non-storm water discharges are listed as allowable per permit part 1.3 and discharged
 All non-storm water discharges that are not allowed are properly contained (see questions 2.12 and 2.16)
 All non-storm water discharges that are contaminated with sediment only (free of chemicals, oils, etc.) will be treated in a sediment basin or equivalent (see permit part 2.8.1).
 Other: [Click here to enter text.](#)

- 2.4** **Is it possible for the total area of disturbance to be phased, minimizing the total exposure of disturbed soil at one time?** (see permit part 2.3.1) **Yes** **No**
If disturbance can be minimized please show the locations on the site map and summarize (here) where disturbances will be delayed for some of the disturbed area: [Click here to enter text.](#)

- 2.5** **What perimeter controls will be used to prevent sediment from leaving the site?** (permit part 2.1.2 & 2.3)

- BMP(s):** Silt Fence Berms
 Vegetative Buffer Cut-Back-Curb
 Staked straw Wattles (Fiber Rolls) Weighted Wattles
 Other: [Click here to enter text.](#)

- 2.6** **Are surface waters located within 30 feet of your project's earth disturbances?** **Yes** **No**

Note: A 30' natural vegetative buffer **MUST** be maintained by water bodies. If a buffer less than 30' is used, you must demonstrate that the additional controls offer the same protection as a 30' natural vegetative buffer, and select the reason for exemption below. (see permit part 2.3.5)

- BMP(s):** 30' Natural Vegetative Buffer
If less than 30' Natural Vegetative Buffer select additional Controls:
 2 Silt Fence Barrier 2 Straw Wattle Barriers (Fiber Roll)
 Other: [Click here to enter text.](#)

- 2.7** **Are there critical or sensitive areas (such as preservation of the drip lines around trees, wetlands, buffer zones by water bodies, etc.) located on or adjacent to the site?** (see permit part 2.2) **Yes** **No**

- BMP(s):** Separate and isolate with environmental fencing
 Other: [Click here to enter text.](#)

- 2.8** **What track out control will be used to prevent dirt from being tracked on streets as vehicles leave the site?** (see permit part 2.4.1)

- BMP(s):** Track Out Pad Cobble Gravel
 Rumble Strips Wash Down Pad Delivery Pad
 Restricted Site Access Selective Access During Dry Weather (Dry soil)
 Other: [Click here to enter text.](#)

- 2.9** **Do you have storm drain inlets on or down gradient of this site?** (see permit part 2.1.3) **Yes** **No**

Protection must address the curb inlet opening (throat) as well as the grate.

Where is/are the nearest downstream inlet(s) and how will you protect them: [Click here to enter text.](#)

- BMP(s):** Rock/Sand-filled Bags Drop Inlet Bags

- Filter Fabric
- Proprietary inlet devices
- Other: Click here to enter text.
- Gravel or Sand filled Wattles

2.10 Will curb ramps be used at the site? (see permit part 2.4.2) Yes No
If curb ramps are used it must be done with material [not dirt] that will not wash away in storm water.
BMP(s): Crushed Rock Wood/Steel Ramps
 Other: Click here to enter text.

2.11 Will there be stockpiles or spoil piles on the site? Yes No
Note: Select "Contained by other BMP" if another BMP on your site will contain runoff from the stockpiles. Materials that can be transported with precipitation must not be placed in the street. (see permit part 2.1.1)
BMP(s): Surrounded by Silt Fence Surrounded by Staked Straw Wattles
 Covered with Tarp Temporary – Removed same day
 Contained by other BMP. Explain: Click here to enter text.
 Other: Click here to enter text.

2.12 Does the project include installation of concrete, masonry, stucco, and paint (water based)work in this project? (see permit part 2.4.5 & 2.9.1) Yes No
Wash water must be contained, the solids dried, and disposed of at a landfill.
BMP(s): Lined Depression Steel Dumpster
 Regional Washout (per development)
 Other: Click here to enter text.

2.13 How will solid waste be dealt with on the site? (see permit part 2.4.3)
Light trash in uncovered dumpsters can blow out and scatter with wind and rain may fall on uncovered leachable material in the dumpster and leak out the bottom causing pollutants to escape.
BMP(s): Bag Lightweight Trash Leak Proof Dumpsters
 Receptacles with Lids Other: Click here to enter text.

2.14 Will there be a need to dispose of solvents, oil, fuel, etc. liquid waste? (see permit part 2.9) Yes No
BMP(s): Contained and Removed from the site Collected for Reuse
 Other: Click here to enter text.

2.15 How will sanitary waste be handled on the site? (see permit part 2.4.4)
BMP(s): Portable Toilet(s) (must be staked down on dirt surface & 10' from curb)
 Onsite or Adjacent Indoor Bathrooms
 Portable Toilet Secondary Containment (secured down with straps to heavy weights)
 Other: Click here to enter text.

2.16 How will you minimize the discharge of pollutants from spills and leaks? (see permit part 2.8.3)
BMP(s): Use of drip pans Offsite fueling, and maintenance
 Spill kit Spill response plan.
 Other: Click here to enter text.

2.17 Will there be a need to store construction materials on site? (see permit 2.8.2) Yes No
Minimize the exposure of materials with a pollution risk (certain building and landscaping materials, fertilizers, pesticides, herbicides, detergents).

- BMP(s):** Covering Erodible or Liquid Materials Secondary Containment
 Strategic Storage and Staging Stored off-site
 Enclose them in a weather proof shed.
 Other: [Click here to enter text.](#)

2.18 **Does your site have steep slopes (greater than 70%)?** (see permit part 2.3.2) **Yes** **No**

- BMP(s):** Erosion Control Blanket Avoid Disturbance on slope
 Seeding Hydroseed
 Mulch Takifiers
 Other: [Click here to enter text.](#)

2.19 **Are there site conditions that cause storm water flows with highly erosive velocities?** (see permit parts 2.3.3 and 2.3.4) **Yes** **No**

Flows must be controlled to minimize sediment transport.

- BMP(s):** Gravel Check Dam Straw Wattles (Fiber Rolls) Check Dam
 Divert Flows around the Site Armored channel (riprap, geotextile, other)
 Other: [Click here to enter text.](#)

2.20 **How will you reduce storm water volume to minimize sediment transport, channel and stream bank erosion?** (see permit parts 2.3.4 and 2.3.3)

- BMP(s):** Utilize basin, depression storage of storm water, cut back curb, or other to hold and infiltrate.
 Prevent heavy equipment (as much as possible) from compacting soil so storm water will infiltrate easier.
 Rip soil after heavy equipment has caused compaction.
 Other: [Click here to enter text.](#)

2.21 **Is there a need for dust control on the site (regulatory or for practical reasons)?** **Yes** **No**

- BMP(s):** Wetting with Water Cover dirt piles with a tarp
 Use Magchloride, Calcium Chloride or Lignan Sulfonate
 Stabilize surface with mulch, gravel or other surface cover
 Other: [Click here to enter text.](#)

2.22 **Will there be disturbed areas on the site that will need to be temporarily stabilized before the project is completed?** (see permit part 2.6) **Yes** **No**

Places that are disturbed and then left for over 14 days with no activity, must be temporarily or permanently stabilized.

- BMP(s):** Bark or other mulch Hydro-mulch Seeding
 Tackifier Staked netting with straw mulch
 Other: [Click here to enter text.](#)

2.23 **Will the house be sold without any landscaping?** **Yes** **No**

If so, how will you leave the site for the new home owner so sediment will be contained on site until the home owner completes landscaping? (the permit can be terminated when the owner occupies the house even though the site is not stabilized).

- BMP(s):** Mulching/Hydro-mulching Swales Silt Fence
 Wattles Cut-Back-Curb Seeding
 Vegetated Buffer Grade Front-Yard Lower than Sidewalk

Other: Click here to enter text.

3. Sequence of Construction Activity

Type of Construction Activity	Approximate Date Range
Start/End of the Project	10-30-19 - 10-30-20
Excavation activities	11 / 2019
Foundation/Footings	11 / 2019
Backfill	11 / 2019
Erection of Building	
Utility Lines installed (you may need to separate this into Plumbing lines, electrical lines, gas lines, water lines, Internet lines, etc.)	11 / 2019
Insert more rows for any stage that should be included	
Landscaping (if the house is sold or occupied by owner with landscaping, if not landscaping should not be included)	

4. Site Map

On a blank page (or include a page from the architectural drawings that show site layout and dimensions), please draw a map (and place this map in Appendix A) showing the layout of the site including locations of:

1. boundaries of project/property
2. boundaries of disturbance (including areas outside of property boundaries)
3. show slopes on site (if there are steep areas show steep areas)
4. location of structures/facilities
5. locations of :
 - a. stockpiles for soils and materials
 - b. construction supplies
 - c. portable toilets
 - d. garbage/trash containers
 - e. egress points/track out pads
 - f. concrete washout pits or containers
6. water bodies, wetlands, natural vegetative buffers
7. placement of all BMPs, perimeter, erosion control, sediment control, inlet protection, etc.
8. storm water inlets and storm water discharge points (where storm water drains off the site)

- 9. areas that will be temporarily or permanently stabilized on the site
- 10. areas where disturbances will be delayed to minimize total exposed surface at one time.

5. Potential Sources of Pollutants

Potential sources of sediment to storm water runoff:

- Clearing and grubbing operations
- Grading and site excavation operations
- Vehicle tracking
- Topsoil stripping and stockpiling
- Landscaping operations

Potential pollutants and sources, other than sediment, to storm water runoff:

- Combined Staging Area—small fueling activities, minor equipment maintenance, sanitary facilities, and hazardous waste storage.
- Materials Storage Area—general building materials, solvents, adhesives, paving materials, paints, aggregates, trash, and so on.
- Construction Activity—paving, curb/gutter installation, concrete pouring/mortar/stucco, and building construction
- Concrete Washout Area

For all potential construction site pollutants, see Table 2 below.

Table 2. Potential construction site pollutants. Circle all that applies to your site and in the last column identify pollution prevention measures to minimize their discharge.

Material/Chemical	Storm Water Pollutants	Common Location*	Pollution Prevention Methods
Pesticides (insecticides, fungicides, herbicides, rodenticide)	Chlorinated hydrocarbons, organophosphates, carbamates, arsenic	Herbicides used for noxious weed control	
Fertilizer	Nitrogen, phosphorous	Newly seeded areas	
Plaster	Calcium sulphate, calcium carbonate, sulfuric acid	Building construction	
Cleaning solvents	Perchloroethylene, methylene chloride, trichloroethylene, petroleum distillates	No equipment cleaning allowed in project limits	
Asphalt	Oil, petroleum distillates	Streets and roofing	
Concrete	Limestone, sand, pH, chromium	Curb and gutter, building construction	
Glue, adhesives	Polymers, epoxies	Building construction	

Material/Chemical	Storm Water Pollutants	Common Location*	Pollution Prevention Methods
Paints	Metal oxides, Stoddard solvent, talc, calcium carbonate, arsenic	Building construction	
Curing compounds	Naphtha	Curb and gutter	
Wood preservatives	Stoddard solvent, petroleum distillates, arsenic, copper, chromium	Timber pads and building construction	
Hydraulic oil/fluids	Mineral oil	Leaks or broken hoses from equipment	
Gasoline	Benzene, ethyl benzene, toluene, xylene, MTBE	Secondary containment/staging area	
Diesel Fuel	Petroleum distillate, oil & grease, naphthalene, xylenes	Secondary containment/staging area	
Kerosene	Coal oil, petroleum distillates	Secondary containment/staging area	
Antifreeze/coolant	Ethylene glycol, propylene glycol, heavy metals (copper, lead, zinc)	Leaks or broken hoses from equipment	
Sanitary toilets	Bacteria, parasites, and viruses	Staging area	

*(Area where material/chemical is used on-site)

6. Spill Prevention and Response Plan

Describe the spill prevention and control plan to include ways to reduce the chance of spills, stop the source of spills, contain and cleanup spills, dispose of materials contaminated by spills, and train personnel responsible for spill prevention and control. Additionally, fill in all **BLUE** fields below.

Spill Plan:

N/A

Any discharges in 24 hours equal to or in excess of the reportable quantities listed in 40 CFR 117, 40 CFR 110, and 40 CFR 302 will be reported to the National Response Center and the Division of Water Quality (DWQ) as soon as practical after knowledge of the spill is known to the permittee. The permittee shall

submit within 14 calendar days of knowledge of the release a written description of: the release (including the type and estimate of the amount of material released), the date that such release occurred, the circumstances leading to the release, and measures taken and/or planned to be taken to the Division of Water Quality (DWQ), 288 North 1460 West, P.O. Box 144870, Salt Lake City, Utah 84114-4870. The Storm Water Pollution Prevention Plan must be modified within 14 calendar days of knowledge of the release to provide a description of the release, the circumstances leading to the release, and the date of the release. In addition, the plan must be reviewed to identify measures to prevent the reoccurrence of such releases and to respond to such releases, and the plan must be modified where appropriate.

Agency	Phone Number
National Response Center	(800) 424-8802
Division of Water Quality (DWQ) 24-Hr Reporting	(801) 538-6146; (801) 536-4123
Utah Department of Health Emergency Response	(801) 580-6681
Local Fire Department	801-782-3580

Minimum spill quantities requiring reporting:

Material	Media Released To	Reportable Quantity
Engine oil, fuel, hydraulic & brake fluid	Land	25 gallons
Paints, solvents, thinners	Land	100 lbs (13 gallons)
Engine oil, fuel, hydraulic & brake fluid	Water	Visible Sheen
Refrigerant	Air	1 lb
Antifreeze, battery acid, gasoline, engine degreasers	Air, Land, Water	100 lbs (13 gallons)

Emphasis to:

- 1st Priority: Protect all people (including onsite staff)
- 2nd Priority: Protect equipment and property
- 3rd Priority: Protect the environment

1. Make sure the spill area is safe to enter and that it does not pose an immediate threat to health or safety of any person.
2. Check for hazards (flammable material, noxious fumes, cause of spill) – if flammable liquid, turn off engines and nearby electrical equipment. If serious hazards are present leave area and call 911. LARGE SPILLS ARE LIKELY TO PRESENT A HAZARD.
3. Stop the spill source and contain flowing spills immediately with spill kits, dirt or other material that will achieve containment.
4. Call co-workers and supervisor for assistance and to make them aware of the spill and potential dangers
5. If spilled material has entered a storm sewer, regardless of containment; contact the City Storm Water Division.
6. Cleanup all spills (flowing or non-flowing) immediately following containment. Clean up spilled material according to manufacturer specifications, for liquid spills use absorbent materials AND DO NOT FLUSH AREA WITH WATER.

7. Properly dispose of cleaning materials and used absorbent material according to manufacturer specifications.
8. Report the reportable quantity to the OGDEN City Storm Water Division.

Emergency Numbers

Utah Hazmat Response Officer 24 hrs	(801)-538-3745
City Police Department	801-778-6600
City Engineering Division	801-731-4519

7. SWPPP, Inspections and Corrective Action Reports

Inspection Schedule and Procedures: The permit requires inspections once a week (see permit Part 3). You must list and provide details of your BMPs in Appendix G. Inspection reports require reporting on BMPs and how effective they are (download inspection reports from the DWQ construction storm water website under the Common Plan Permit). You may be required to maintain, modify, remove, or apply/install more or different BMPs to control pollutants on the site. Please number your BMPs in Appendix G and refer to those numbers on your inspection reports and corrective action reports when you inspect or report on them.

Describe the general procedures for correcting problems when they are identified. Include responsible staff and time frames for making corrections:

~~Click here to enter text.~~

Address them and correct them

Inspections and Corrective Actions: All inspections and corrective actions must be logged using the "Inspection/Correction Action Log" attached in Appendix E. The log should be filled out completely for each BMP.

8. Training of Sub-Contractors

All sub-contractors, installers of utility connections, and others that perform activities that are affected by permit requirements will be informed about permit requirements that pertain to their scope of work.

Sub-Contractors that have been informed:

Contractor	Date	Topic(s) Covered	Initials of Trainer
Excavator			
Gas utilities			
Plumbing connection			
Electrical connection			

Concrete foundation walls			
Concrete flat work			
Landscaper			
Other: Click here to enter text.			
Other: Click here to enter text.			
Other: Click here to enter text.			
Other: Click here to enter text.			

9. Changes to the SWPPP

All changes to this SWPPP must be redlined, dated, and initialed in the SWPPP document and on the site map.

10. Record Keeping

The following items should be kept at the project site available for inspectors to review:

1. A copy of the Common Plan Permit (Appendix B)
2. The signed and certified NOI form (Appendix C)
3. Inspection reports (Appendix E)

11. Delegation of Authority (if any)

Duly Authorized Representatives or Positions:

Company/Organization: Mac Builders

Name: Wendy Lallis

Position: Admin. Assistant

Address: 735 w 2400 s

City: Syracuse

Telephone: 801-773-4439

State: UT Zip: 84075

Fax/Email: office@macbuildersutah.com

Owner/General Contractor Signature: _____

Date: 10/30/2019

Additional Duly Authorized Representatives or Positions:

Company/Organization:

Address:

City:

Telephone:

State:

Fax/Email:

Zip:

Owner/General Contractor Signature: _____

Date: _____

12. Discharge Information

Does your project/site discharge storm water into a Municipal Separate Storm Sewer System (MS4)?

Yes No

Municipal Storm Drain System receiving the discharge from the construction project: [Click here to enter text.](#)

Receiving Waters (look up

<https://deq.utah.gov/ProgramsServices/programs/water/standards/WQmap.htm> to identify your receiving water body)

Enter the name(s) of the first surface water(s) that receives storm water directly from your site and/or from the MS4 listed above. **Note:** *multiple rows provided in the case that your site has more than one point of discharge in which each flows to different surface waters.*

1. **WEBER RIVER**
- 2.
- 3.
- 4.

Impaired Waters (refer to <http://mapserv.utah.gov/surfacewaterquality/> in the left hand column to determine status of receiving water body).

Select any impaired surface water(s) that your site will discharge to, either directly or through the MS4 selected above.

Impaired Surface Water	Is this surface water impaired?	Pollutant(s) causing the impairment	Has a TMDL been completed?	Pollutant(s) for which there is a TMDL
Click here to enter text.	<input type="checkbox"/> Yes <input type="checkbox"/> No	Click here to enter text.	<input type="checkbox"/> Yes <input type="checkbox"/> No	Click here to enter text.
Click here to enter text.	<input type="checkbox"/> Yes <input type="checkbox"/> No	Click here to enter text.	<input type="checkbox"/> Yes <input type="checkbox"/> No	Click here to enter text.

13. Certification and Notification

I, Wendy Lallis, certify under penalty of law that this document and all attachments were prepared under my direction or supervision in accordance with a system designed to assure that qualified personnel properly gathered and evaluated the information submitted. Based on my inquiry of the person or persons who manage the system, or those persons directly responsible for gathering the information, the information submitted is, to the best of my knowledge and belief true, accurate, and complete. I am aware that there are significant penalties for submitting false information, including the possibility of fine and imprisonment for knowing violations.

This SWPPP should be signed and certified by the construction operator(s).

APPENDIX B: Common Plan Permit

Find the permit on <https://deq.utah.gov/Permits/water/updes/stormwatercon.htm>

General Permit for Storm Water Discharges from Construction Activities
STATE OF UTAH, DEPARTMENT OF ENVIRONMENTAL QUALITY,
DIVISION OF WATER QUALITY

General Storm Water Permit for Construction Activity
Connected with Single Lot Housing Projects
Utah Pollution Discharge Elimination System Permit No. UTRH00000
(Common Plan Permit)

This Permit is issued in compliance with the provisions of the Utah Water Quality Act (Utah Code Annotated 19-5, as amended) the federal Water Pollution Control Act (33 United States 1251 et. seq., as amended by the Water Quality Act of 1987, Public Law 100-4), and the rules and Regulations made pursuant to those statutes.

This permit applies to "construction activity" for a single lot disturbing a total of one acre or less and for construction activities related to residential dwellings. A single lot covered by this permit is part of a common plan of development or sale (see definitions in Part 6).

Issuance of this permit does not authorize any permittee to violate water quality standards. The permittee shall develop best management practices (BMPs) and engage in activities that will protect water quality during the construction project.

This permit shall become effective on February 1, 2016.

This permit and the authorization to discharge expire at midnight on January 31, 2021.

Signed this 20 day of January, 2016



Walter L. Baker, P.E.
Director



TABLE OF CONTENTS

1. COVERAGE UNDER THIS PERMIT.....	1
1.1. <u>Coverage Limitations</u>	1
1.2. <u>Discharges Allowed</u>	1
1.3. <u>Non-Storm Water Discharges</u>	1
1.4. <u>How to Obtain Permit Coverage</u>	1
1.5. <u>Signature on the NOI</u>	2
1.6. <u>Permit Renewal</u>	2
1.7. <u>Start and end of Permit Coverage</u>	2
1.8. <u>Notice of Termination</u>	3
1.9. <u>Water Quality</u>	3
1.10. <u>Requirement to Post a Notice of Permit Coverage</u>	3
2. POLLUTION PREVENTION REQUIREMENTS.....	4
2.1. <u>Structural Controls</u>	4
2.2. <u>Protection of Critical or Sensitive Areas</u>	4
2.3. <u>Managing the Site to Minimize Sediment Transport Off Site</u>	4
2.4. <u>Good Housekeeping Measures</u>	5
2.5. <u>Soil Compaction/Top Soil</u>	6
2.6. <u>Stabilization Requirement</u>	6
2.7. <u>Construction Dewatering</u>	7
2.8. <u>Pollution Prevention Measures</u>	7
2.9. <u>Prohibited Discharges</u>	7
3. SELF-INSPECTION REQUIREMENTS.....	9
3.1. <u>Inspector Qualifications</u>	9
3.2. <u>Self-Inspections</u>	9
3.3. <u>Weekly Self-Inspection Requirements</u>	9
3.4. <u>Weekly Inspection Reports</u>	10
3.5. <u>Corrective Action</u>	10
4. STORM WATER POLLUTION PREVENTION PLAN (SWPPP).....	11

General Storm Water Permit for Construction Activity Connected with Single Lot Housing Projects
UPDES Permit No. UTRH00000

4.1. <u>SWPPP Requirement</u>	11
4.2. <u>Contents of a SWPPP</u>	11
5. STANDARD PERMIT CONDITIONS.....	14
5.1. <u>Duty to Comply</u>	14
5.2. <u>Duty to Reapply</u>	14
5.3. <u>Need to Halt or Reduce Activity not a Defense</u>	14
5.4. <u>Duty to Mitigate</u>	14
5.5. <u>Duty to Provide Information</u>	14
5.6. <u>Other Information</u>	14
5.7. <u>Oil and Hazardous Substance Liability</u>	15
5.8. <u>Property Rights</u>	15
5.9. <u>Severability</u>	15
5.10. <u>Record Retention</u>	15
5.11. <u>Addresses</u>	15
5.12. <u>State Laws</u>	15
5.13. <u>Proper Operation and Maintenance</u>	15
5.14. <u>Inspection and Entry</u>	15
5.15. <u>Reopener Clause</u>	16
5.16. <u>Signatory Requirements</u>	16
6. DEFINITIONS	18

General Storm Water Permit for Construction Activity Connected with Single Lot Housing Projects
UPDES Permit No. UTRH00000

1. COVERAGE UNDER THIS PERMIT. Conditions for coverage under this permit.

1.1. Coverage Limitations. A project site (see definition of a project site in Part 6) is eligible for this permit if it meets the following requirements:

1.1.1. It is found within the State of Utah but is not in Indian Country,

1.1.2. The construction activity is related to residential building on an individual lot or parcel.

1.1.3. It disturbs a total of one acre or less over the duration of the construction project,

1.1.4. *Multiple site coverage*:

1.1.4.a. This permit may apply to multiple lots with the contingency that each lot be covered under a different permit tracking number (separate permit coverage for each lot). Lots do not necessarily need to be located within the same sub-division.

1.1.4.b. If multiple lot coverage is desired under one permit, it may be obtained under the General Permit for Discharges from UPDES Permit No. UTRC00000. Multiple lots may be covered under one tracking number (one permit coverage) provided that UTRC00000 is the controlling permit, and all lots covered under that tracking number are within the same sub-division.

1.2. Discharges Allowed. This permit allows discharges of storm water from construction activity at a project site, provided the storm water discharge meets the requirements within this permit.

1.3. Non-Storm Water Discharges. Other non-storm water discharges that are allowed are:

1.3.1. Flushings from potable or irrigation water sources where they have not been used for a washing or cleaning activity;

1.3.2. Water used for dust control;

1.3.3. Spring water and groundwater that have not been soiled with sediment or other pollutants from construction activity;

1.3.4. Emergency fire-fighting activities, and;

1.3.5. Footing drains that have not been soiled from construction activity.

1.4. How to Obtain Permit Coverage. The permit may be obtained online at the Utah Department of Environmental Quality (DEQ) UPDES Permits website at <http://www.waterquality.utah.gov/UPDES/stormwatercon.htm>. Click on "Application for a Storm Water Permit". Create an account, or if an account has already been created, proceed with providing the information requested. **The notice of intent (NOI) for this permit is the same NOI that is used for the UTRC00000 permit.** To complete the application process the permittee must pay a permit fee. The NOI may be filled out electronically using the online permit application system. The NOI can also be submitted using a paper form obtained from the same website cited above along with the permit fee. The paper form and fee can either be hand delivered to Utah Division of Water Quality [DWQ], 195 North 1950 West, Salt Lake City, Utah, 3rd floor in the MASOB building, or mailed to DWQ, P.O. Box 144870, Salt Lake City, Utah 84114-4870. When a party receives coverage under the permit, they will receive a permit

General Storm Water Permit for Construction Activity Connected with Single Lot Housing Projects
UPDES Permit No. UTRH00000

tracking number and the opportunity to copy the NOI for "proof of coverage." A copy of this permit may be downloaded from the DEQ website at <http://www.deq.utah.gov/Permits/water/updes/stormwatercon.htm>.

- 1.5. Signature on the NOI. The owner and the general contractor, which in some cases could be the same party, must sign the paper copy of the NOI (see 5.16.1.a) and place it in the storm water pollution prevention plan (SWPPP) (see 4.2.8).
- 1.6. Permit Renewal. This permit must be renewed yearly on the anniversary date of the original permit application. This is done by logging onto the account created at the time of NOI application, refreshing the information on the NOI, and paying the yearly permit fee.
- 1.7. Start and end of Permit Coverage. Permit coverage begins immediately upon completion and submission of an NOI and the permit fee. If the NOI is submitted electronically on-line permit coverage begins on that day. If the NOI is submitted by mail permit coverage begins when the NOI is received and entered into the on-line data base by DWQ staff. For projects within the jurisdiction of a regulated MS4 (see definitions in Part 6; the list of regulated MS4's is found on <http://www.deq.utah.gov/Permits/water/updes/stormwatermun.htm>), the permittee must also notify and receive approval for the project from the regulated MS4 having jurisdiction before the project may commence (see 4.2.10.). The permit fee is an annual fee that must be paid yearly on the anniversary date of permit issuance. The permit will remain effective until or unless any of the following occurs:
 - 1.7.1. The permittee completes the notice of termination (NOT) process, as outlined in section 1.8,
 - 1.7.2. The permittee fails to submit the yearly permit fee,
 - 1.7.3. Aside from permit coverage, which may be renewed annually by the permittee, as needed, this general permit expires every 5 years and normally is renewed through a public notice process by DWQ. In the event that the permit nears the end of its 5 year cycle, and the year of permit coverage for a construction site extends beyond the expiration date for the permit, the permittee must request continuing coverage through the permit renewal process. Otherwise permit coverage for a construction site will terminate when the general permit expires. Renewal of permit coverage can be done in the online electronic storm water data base up to 12 months prior to the expiration of the permit, or by letter received by DWQ before the expiration date of the specific permit coverage in question where concurrently all entries in the NOI can be updated as needed.
 - 1.7.3.a. If a renewal permit has been issued and is in place at the expiration date of this permit, this permit will terminate and coverage under the renewed permit will begin on the expiration date unless 1.7.1 has been invoked by the permittee.
 - 1.7.3.b. If a renewal permit has not been issued, this permit will be administratively extended until a renewal permit is issued or it is determined that this permit will not be continued. If a renewal permit is issued, and the permittee indicated a desire for continuing coverage under the new permit, coverage

General Storm Water Permit for Construction Activity Connected with Single Lot Housing Projects
UPDES Permit No. UTRH00000

will continue for the permittee under the new permit coverage unless 1.7.1 is invoked. If the permit is discontinued, the permittee must continue coverage under another general permit or an individual permit.

- 1.7.4. Coverage under this permit is rescinded or revoked for administrative reasons. In this case, the permittee will be notified in writing from the Director and will be required to apply for coverage under a different general or individual UPDES permit. This permit is terminated on the day coverage under another permit begins.
- 1.8. Notice of Termination. The permittee must terminate the permit by submitting an NOT when the project is completed. The NOT must be filed and retained for 3 years after the permit has been terminated (see 3.7). To terminate the permit, the permittee must comply with either 1.8.1 or 1.8.2, outlined below, and must comply with 1.8.3 if the project is within the jurisdiction of a regulated MS4 (see <http://www.deq.utah.gov/Permits/water/updes/stormwatermun.htm> for regulated MS4s):
- 1.8.1. The landscaping is completed and the site meets "final stabilization" requirements (see part 6, definitions, for final stabilization).
- 1.8.2. When a project (residential building) is completed but 'final stabilization' is not established, the building must be in process of being sold and ready for homeowners to take possession. If built by the homeowners, they must be in the process of moving in or already have moved in the house. The lot must have perimeter controls on downslope boundaries and surface stabilization controls on all surfaces that are 20 % (1 to 5 slope, or 11.3 degrees) or greater to prevent erosion and soil migration offsite;
- 1.8.3. The permittee must submit a paper copy of a NOT form to the MS4 of jurisdiction and schedule a final inspection (with the MS4). Termination is complete upon approval of the final inspection from the local MS4, or from DWQ if outside the jurisdiction of a regulated MS4.
- 1.9. Water Quality: Through the design of appropriate BMPs, it is expected that the permittee will achieve compliance with water-quality standards. If additional information becomes available indicating a project site is causing or is contributing to a violation of water quality standards or an existing total maximum daily load (TMDL), coverage under this permit may be revoked or rescinded, and the permittee may be required to get coverage under an individual UPDES permit or another UPDES general permit. If this occurs, the owner and the general contractor will be notified in writing by the Director and given instructions on how they must proceed.
- 1.10. Requirement to Post a Notice of Permit Coverage. The permittee must post a sign at the project site that includes the UPDES Permit tracking number, owner or general contractor contact name, a phone number for the owner or general contractor, an email address for the owner or general contractor, and in the case of an electronic SWPPP, a web address or information on how to access the electronic SWPPP. The notice must be posted with lettering large enough to be readable from a public right-of-way.

2. POLLUTION PREVENTION REQUIREMENTS

2.1. Structural Controls. Minimize sediment transport off the site as follows:

- 2.1.1. *Stockpiled Material*. Stockpiled material must not be stored on an impervious surface, except a material that will not be transported with precipitation, such as two-inch graded and washed gravel, unless it will be permanently placed and the holding area will be swept clean the same day it is dropped. If stored temporarily for more than a day, it must be placed as far as feasibly possible from roads or other impervious surfaces, storm water inlets, or water bodies, and with stockpile perimeter runoff controls utilized.
- 2.1.2. *Perimeter Controls*. Perimeter controls such as silt fences, straw wattles, other filter berms, cut back curbs, vegetative buffers, etc., must be properly placed on the downslope sides of the project to prevent sediment from leaving the site during a storm event. As perimeter controls become loaded to 1/3 of capacity, they must be cleaned.
- 2.1.3. *Inlet Protection*. Storm-drain inlets on the project site and on adjacent roads immediately down gradient from the site must be protected if they receive drainage from the active construction site. Protection may be, but is not limited to, rock wattles, sand bags, proprietary devices, or other. Rock wattles and sand bags are not advised for use in winter because they can be destroyed or removed by snow plows.

2.2. Protection of Critical or Sensitive Areas: Critical or sensitive areas such as preservation of the drip line around trees, wetlands, buffer zones by water bodies, etc., must be separated and isolated by clearly marking the areas with environmental fencing.

2.3. Managing the Site to Minimize Sediment Transport Offsite.

- 2.3.1. The total area of soil disturbance at any one time must be minimized by disturbing only the area necessary to complete that stage of construction in the construction process.
- 2.3.2. Soil disturbances on steep slopes must be minimized. For purposes of this permit a steep slope is 70% (or 1 to 1.66, or 35 degrees), or greater. This means avoiding a disturbance of soils on steep slopes or if disturbing the soil surface is necessary providing a robust surface stabilizing cover (such as geomats, environmental blankets, or other robust slope stabilizing control) to prevent erosion.
- 2.3.3. Storm water volume and velocity must be controlled to minimize soil erosion and sediment transport by methods such as allowing or not obstructing infiltration and using velocity-control devices to reduce energy in runoff flowing on slopes.
- 2.3.4. Storm water discharges leaving the site, including both peak flow rates and total storm water volume, must be controlled to minimize channel and stream-bank erosion and scour in the immediate vicinity of discharge points. This may be accomplished using experience, estimates, and good judgement; unless unusual or extraordinary site conditions present a potential for excessive erosion, hillside/impoundment collapse, environmental/safety hazards, or other site problems; for which a professional engineer must be consulted.

- 2.3.5. *Thirty-Foot Vegetative Buffer.* If a waterbody is adjacent to, within 30 feet from, or passing through the project boundaries, a 30-foot natural buffer between the waterbody and construction activity must be provided. If a 30-foot natural buffer cannot be provided, a substitute control measure equivalent to the 30-foot buffer must be provided, or the SWPPP must contain an explanation why neither is feasible. If it is not feasible to maintain a 30-foot natural buffer, as much natural buffer as is possible must be preserved and coupled with placement of additional erosion and sediment controls designed, implemented, and maintained to substitute and be equivalent to the 30-foot natural buffer.

The requirement for a natural buffer or substitute controls does not apply to any area outside of the project boundaries, but if a waterbody is within, for example, 20 feet from the project boundary, there must be 10 feet of natural vegetative buffer or substitute controls, or if within 25 feet from the project boundary, there must be 5 feet of natural vegetative buffer or substitute controls, and so forth.

- 2.3.5.a. Substitution for a natural buffer should be calculated with models such as USDA's RUSLE2 or WEPP, or by using SEDCAD, SEDIMOT, or other similar models. In lieu of using a model for calculation of a substitution buffer, the permittee shall deploy the following:

2.3.5.a.i. For every full 9 feet of natural buffer that is not provided on slopes up to 10 percent, one row of an effective perimeter control, such as a silt fence, staked straw wattle, proprietary or other filter berm, or other perimeter control, must be properly placed. For example, if only 15 feet of natural buffer can be provided, the permittee will substitute one row of a perimeter control in addition to the 15 feet of natural buffer to make up for the 15 feet of buffer that could not be preserved.

2.3.5.a.ii. In addition to the requirements above for substitutions in place of the 30-foot natural buffer, on slopes between 10 percent and 30 percent, five feet of surface stabilization must be placed down gradient of and between each perimeter control substituted. For slopes steeper than 30 percent, 6 feet of surface stabilization must be placed downgradient of and between each perimeter control substituted, such as mulch, hydromulch, wood chips, bark, compost, erosion mat, etc., but excluding tackifiers.

- 2.4. Good Housekeeping Measures. The permittee must address the following:

- 2.4.1. *Track Out.* Track-out pads (see definitions) and or rumble strips (see definitions) must be used to prevent dirt/mud tracked on streets as vehicles leave the site. If traffic onto and off the site is not frequent, a site operator may impose a blanket prohibition of vehicle traffic onto the site, allowing for the occasions to deliver and unload, but afterwards providing sweeping and/or cleaning of tracked out dirt (keep in mind that vehicles leaving a muddy site with no track out protection can track mud for several

blocks – the operator is liable for all track out from the site except for a dirt stain after sweeping -- see note after 3.2.2.). Dirt or mud tracked out on the street must not be washed or hosed into a storm drain. Tracked out mud or dirt on the street must be swept and/or scraped up as needed every day (see 3.2.2).

- 2.4.2. *Curb Ramps*: This permit prohibits the intentional placement of dirt and/or mud on paved streets or sidewalks. Curb ramps may be crushed rock, wood or steel ramps, or another material that does not wash away with storm water.
 - 2.4.3. *Waste and Debris*. The site must be cleaned of waste and debris daily (see daily self-inspection 3.2.2). Waste and debris must be contained and secured adequately to prevent scattering from wind until it is removed from the site and disposed of properly.
 - 2.4.4. *Portable Toilet*. Portable toilets must be tied down, staked down, or secured using other measures to prevent turn over, and they must be placed away from a road gutter, storm water inlet, or waterbody.
 - 2.4.5. *Washing of Concrete, Stucco, and Paint Equipment*. A plastic film-lined pit or sealed container must be provided for washout of equipment used for concrete, stucco, and water-based paint. After completion of concrete, stucco, and paint tasks, the permittee must dispose of the waste by drying and sending solids to a landfill. Oil-based paint cleanout must be done in containers, taken off-site, and disposed of separately.
- 2.5. Soil Compaction/Top Soil. Topsoil must be preserved and placed on areas to be landscaped or areas planned for receiving vegetative cover, unless infeasible. Soil compaction must be minimized on areas that will not be used for support of structural elements such as roads, parking areas, structures, etc., unless infeasible.
- 2.6. Stabilization Requirement. Stabilization requirements are as follows:
- 2.6.1. *Stabilization requirements for areas that receive 20 inches of rainfall annually or greater*: Stabilization of disturbed areas must, at a minimum, be initiated immediately whenever any clearing, grading, excavating or other earth disturbing activities have permanently ceased on any portion of the site or have temporarily ceased on any portion of the site for greater than 14 calendar days. Stabilization can be sodding, planting, application of mulch (wood chips, rock, gravel, bark, compost, cat tracking on straw, hydromulch, etc.), application of geotextiles or erosion blankets, application of a tackifier, seeding (including preparation for germination and growth), a combination of these methods, or other method.
 - 2.6.2. *Stabilization or equivalent requirements for arid and semi-arid areas (areas receiving less than 20 inches of rainfall annually)*: Stabilization for visually flat areas is not required (roughly up to 5 percent, 1 to 20 slope, or 2.3 degrees slope). Areas with slopes up to roughly 20 percent (1 to 5 slope or 11.3 degrees) must have, at minimum, velocity-control devices in every area where storm water collects and flows, spaced close enough across the flow to stop erosion (see also 2.3.3). Soil surface stabilization such as sodding, planting, hydromulch, compost, bark, cat tracking on straw, gravel,

General Storm Water Permit for Construction Activity Connected with Single Lot Housing Projects
UPDES Permit No. UTRH00000

geotextiles, erosion blankets, or other stabilization methods is required on all other sloped areas, increasing the robust nature of stabilizing cover commensurately with increasingly steeper slopes.

2.6.3. *Permanent Stabilization for Arid areas.*

2.6.3.a. In addition to requirements above (see 2.6.2), permanent stabilization requires seeding on all areas that are not covered with permanent stabilization elements or structural elements such as building structure or pavement, or that are engineered or intended for structural purposes like graveled parking or dirt roads.

2.6.3.b. Disturbed areas on projects located outside of populated and developed areas and where no irrigation water is available and where future periodic landscaping maintenance is not planned must be reclaimed with a seed mix of plants indigenous to the area or tolerant to the local climatic conditions that does not include invasive species. Velocity-control devices may be permanent or temporary. If velocity-control devices are intended for temporary use, they must be biodegradable and designed durable enough to withstand extreme weather.

2.7. Construction Dewatering. Construction dewatering can occur onsite without an additional UPDES permit if it is infiltrated or contained onsite and is not discharged offsite. Otherwise, construction dewatering discharges must be permitted under the General Permit for Construction Dewatering and Hydrostatic Testing UPDES Permit UTG070000, which can be obtained online through submittal of an NOI at <https://secure.utah.gov/waterquality>.

2.8. Pollution Prevention Measures. The permittee must design, install, implement, and maintain effective pollution prevention measures to minimize the discharge of pollutants. At a minimum, such measures must address the following:

2.8.1. *Vehicle, Wheel, and Other Washing.* Minimize the discharge of pollutants from equipment and vehicle washing, wheel-wash water, and other wash waters. Wash waters must be treated in a sediment basin or alternative control that provides equivalent or better treatment prior to discharge

2.8.2. *Exposure to Pollutants.* Minimize the exposure of building materials, building products, construction wastes, trash (see 2.4.3), landscape materials, fertilizers, pesticides, herbicides, detergents, sanitary waste (see 2.4.4), and other materials present on the site to precipitation and to storm water. Minimization of exposure is not required in cases where the exposure to precipitation and to storm water will not result in a discharge of pollutants, or where exposure of a specific material or product poses little risk of storm water contamination (e.g., final products and materials intended for outdoor use).

2.8.3. *Leaks and Spills.* Minimize the discharge of pollutants from spills and leaks and implement chemical spill and leak prevention and response procedures.

2.9. Prohibited Discharges. The following discharges are prohibited:

2.9.1. Wastewater from washout or cutting of concrete (see 2.4.5),

General Storm Water Permit for Construction Activity Connected with Single Lot Housing Projects
UPDES Permit No. UTRH00000

- 2.9.2. Wastewater from washout and cleanout of stucco, paint, form release oils, curing compounds, and other construction materials (see 2.4.5),
- 2.9.3. Fuels, oils, or other pollutants used in vehicle and equipment operation and maintenance,
- 2.9.4. Soaps or solvents used in vehicle and equipment washing.

3. SELF-INSPECTION REQUIREMENTS.

3.1. Inspector Qualifications. Weekly inspections (see 3.2.1 below) must be done by a qualified person. A qualified person means a person knowledgeable in the principles and practices of erosion and sediment control that possesses the skills to:

- 3.1.1. Assess conditions at the construction site that could impact storm water quality,
- 3.1.2. Assess the effectiveness of a storm water control measure selected to control the quality of storm water discharges from the construction activity.

3.2. Self-Inspections.

3.2.1. *Weekly Self Inspections:* Self-inspections must occur every 7 days. A written report is required (see 3.4).

3.2.2. *Daily Site Check:* Each day of construction activity, the site must be inspected for dirt in the street and trash on the site. Streets must be swept clean (see note below), if soiled. Dirt must be removed off the street (not swept or washed into the storm drain system). Trash on the site must be picked up and disposed of into trash containers (see 2.4.3.) or disposed of off-site (e.g., municipal/private garbage collection service or construction waste landfill). Sub-contractors must be held responsible by the permit holder to perform these duties in accordance with this paragraph for the activities they are contracted to perform. A written report is not required, however the operator will keep a daily log (for the active construction days) listing the initials of the person doing the site check.

Note: Swept clean means sweeping and scraping. Scraping if there is dirt left behind that is crusted and that sweeping will not pick up. This does not mean removing the microscopic layer of dust or the minute amounts of dirt in the cracks and crevices of the surface left behind staining the pavement.

3.3. Weekly Self-Inspection Requirements.

3.3.1. *Areas to check include the following:*

- 3.3.1.a. Areas that have been cleared, graded, or excavated that are not stabilized,
- 3.3.1.b. All storm water control measures, including perimeter controls,
- 3.3.1.c. Material piles, waste-disposal containers, sanitary facilities, loose trash, litter, washout areas, portable toilets, track out pad, egress points (if any), etc.,
- 3.3.1.d. Storm water conveyances through the site, treatment areas, and drainages,
- 3.3.1.e. All storm water discharge points, street gutters, storm water inlets,
- 3.3.1.f. Areas that have been temporarily stabilized,
- 3.3.1.g. Areas that have been permanently stabilized and are completed do not need further inspections.

3.3.2. *Items to check include the following:*

- 3.3.2.a. All erosion and sediment controls and other pollution prevention controls

General Storm Water Permit for Construction Activity Connected with Single Lot Housing Projects
UPDES Permit No. UTRH00000

have been installed, are operational, and are working as intended to minimize pollutant discharges. Determine if any controls need to be replaced, repaired, or maintained.

3.3.2.b. Identify any locations where new or modified storm water controls are necessary.

3.3.2.c. Signs of visible erosion and sedimentation (i.e., sediment deposits) that have occurred and are attributable to discharges from your site,

3.4. Weekly Inspection Reports. The weekly self-inspection report must be written within 24 hours of inspection and must include:

3.4.1. The initials of the person doing the inspection,

3.4.2. The date of the inspection,

3.4.3. The weather during the inspection,

3.4.4. The problems that were found needing correction (as they pertain to 3.3.1 and 3.3.2 above),

3.4.5. The date when corrective action is completed,

3.4.6. All self-inspection reports must be filed with other permit records regarding the permit. Inspection reports must be available during an oversight inspection.

3.5. Corrective Action: Corrective action must be completed before the next weekly inspection.

3.6. Inspections by an Oversight Authority. A copy of an oversight inspection report must be filed and be available for review during other oversight inspections.

3.7. Record Keeping. Records regarding this permit, the NOI, the NOT, the SWPPP, inspection reports, other related information and documents must be preserved for 3 years after the submission of the NOT (see 5.10).

4. STORM WATER POLLUTION PREVENTION PLAN (SWPPP).

4.1. SWPPP Requirement. The permittee must prepare a SWPPP before the NOI for the project is submitted. The SWPPP must address all the applicable requirements in Part 2.

4.1.1. *SWPPP Site Design*. The design, installation, and maintenance of erosion and sediment controls must address factors such as the amount, frequency, intensity and duration of precipitation; the nature of resulting storm water runoff; and soil characteristics, including the range of soil particle sizes expected to be present onsite. These may be accomplished using experience, estimates, and good judgement, unless unusual or extraordinary site conditions create hazards for which a professional engineer must be consulted.

4.1.2. *Surface Outlets*: When discharging from basins and impoundments, utilize outlet structures that withdraw water from the surface, unless infeasible.

4.2. Contents of a SWPPP. A SWPPP must contain the following:

4.2.1. *Contacts*. The contacts for the site with contact information (name, address, telephone, email) including owner, general contractor, and any other party that significantly affects the implementation of the SWPPP or has responsibilities over the SWPPP.

4.2.2. *Sequence and Estimated Dates of Construction Activities*. Listed in the sequence with estimated dates including the following:

4.2.2.a. Start and end of excavation activities, initial excavation, backfill excavation and final grading,

4.2.2.b. Any temporary or permanent cessation of earth-disturbing activities,

4.2.2.c. Start and end of landscaping if this is done as part of the construction activity before the home is sold.

4.2.3. *Site Map or Chart*. A site map may be hand drawn (as close to scale as possible) or may be a copy of an architect drawing including the following information:

4.2.3.a. Boundaries of the property,

4.2.3.b. Boundaries of soil surface disturbances, including any outside the boundaries of the property,

4.2.3.c. Slopes, including areas of steep slopes,

4.2.3.d. Locations of stockpiles of soils, storage of construction materials, portable toilets, trash containers, concrete washout pits or containers, egress points, and track out pads,

4.2.3.e. Waterbodies, wetlands, and natural buffer areas,

4.2.3.f. Locations and types of BMPs or storm water control measures for the control and/or treatment of storm water flowing onto, through, and/or offsite,

4.2.3.g. Locations of storm water inlets, storm water discharge points going off site,

General Storm Water Permit for Construction Activity Connected with Single Lot Housing Projects
UPDES Permit No. UTRH00000

- 4.2.3.h. Areas that will be temporarily or permanently stabilized during the construction period.
- 4.2.4. *Thirty-Foot Natural Buffer.* The SWPPP must show the dimensions and placement of the 30-foot natural buffer, the substitute control measures, or a detailed explanation of why a natural buffer or substitute control measure could not be applied.
- 4.2.5. *Pollutants.* A list of construction site pollutants including the pollutant-generating activity, and an inventory of pollutants for each pollutant generating activity (e.g., paints, solvents, form oil, fuels, and other chemicals; applications, materials, and liquids that if released could pollute storm water).
- 4.2.6. *Waste Management.* Waste management procedures including soil removal, clearing debris removal, demolition removal, trash disposal, construction-waste disposal, and sanitary-waste disposal.
- 4.2.7. *Training.* The permittee will ensure that each subcontractor or utility provider is aware of their responsibilities for keeping soil on the site and preventing pollution. The permittee must keep in mind that they are responsible for and may be issued fines for poor performances by their subcontractors and utility providers. Consideration will be given if the permittee can document when and what instructions were given to the subordinate party.
- 4.2.8. *NOI and Permit.* The SWPPP must contain a copy of this permit and a copy of the NOI for the project.
- 4.2.9. *SWPPP Signature and Certification.* The SWPPP must be signed and certified by both the Owner and the General Contractor in accordance with 5.16.1.a.
- 4.2.10. *MS4 Approval of Project.* For areas where projects are within a regulated MS4's jurisdiction (see definitions in Part 6; the list of regulated MS4's is found on <http://www.deq.utah.gov/Permits/water/updes/stormwatermun.htm>), the SWPPP must contain the signature and date of the MS4 reviewer who has approved the proposed project for construction (see 1.7.).
- 4.2.11. *Availability of the SWPPP.* The SWPPP must be available at the construction site covered under this permit during onsite construction activity, unless the SWPPP is available online. If the SWPPP is available online there must be a sign (see 1.10) that describes where the SWPPP can be accessed online. The SWPPP is a plan for the site, and workers must be able to refer to the SWPPP and update it as needed to manage the site (including SWPPPs found on the internet). The SWPPP is not required to be on the site when construction workers leave for the day or when there is no activity occurring on the site, but at all times there must be posted contact information where the SWPPP can be obtained (see Part 1.10). The SWPPP must be made available within 24 hours to DWQ representatives or other oversight inspectors, e.g., U.S. Environmental Protection Agency [EPA] or a local MS4, on request, or immediately during an inspection on the site when there are workers and activity at the site.

General Storm Water Permit for Construction Activity Connected with Single Lot Housing Projects
UPDES Permit No. UTRH00000

- 4.2.12. *Required Modifications of the SWPPP.* The SWPPP must be modified as follows:
- 4.2.12.a. During inspections when it is determined from observations of site conditions that storm water control measures are:
 - 4.2.12.a.i. Not adequate or not shown in the SWPPP, or
 - 4.2.12.a.ii. Changes in the SWPPP are necessary for compliance with this permit.
 - 4.2.12.b. When an oversight authority determines that the SWPPP is not adequate based on missing a required SWPPP or permit item, not addressing pollutants properly, not being up to date and reflecting current site conditions, or not being clear, thorough, and understandable.
- 4.2.13. *SWPPP Modifications Deadline.* Modifications to the SWPPP from inspections or oversight authority direction must occur before or during the next weekly inspection.

5. STANDARD PERMIT CONDITIONS.

5.1. Duty to Comply.

5.1.1. The permittee must comply with all conditions of this permit. Any permit noncompliance constitutes a violation of the Utah Water Quality Act (the Act) and is grounds for enforcement action; for permit termination, revocation and reissuance, or modification; or for denial of a permit renewal application.

5.1.2. *Penalties for Violations of Permit Conditions*

5.1.2.a. *Violations.* The Act provides that any person who violates the Act, Utah wastewater or storm water rules, or conditions of a permit issued under the Act, is subject to a fine of \$10,000 per day.

5.1.2.b. *Willful or Gross Negligence.* The Act provides that any person who discharges a pollutant to waters of the State as a result of criminal negligence or who intentionally discharges is criminally liable and is subject to imprisonment and a fine of up to \$50,000 per day (Utah Code Annotated 19-5-115).

5.1.2.c. *False Statements.* The Act provides that any person who knowingly makes any false material statement, representation, or certification in any application, record, report, plan, or other document filed or required to be maintained under the Act, the rules, or this permit, or who knowingly falsifies, tampers with, or renders inaccurate, any monitoring device or method required to be maintained under the Act shall upon conviction, be punished by a fine of not more than \$10,000 or by imprisonment for 6 months, or by both (Utah Code Annotated 19-5-115(4)).

5.2. Duty to Reapply. If a permittee wishes to continue an activity regulated by this permit after the expiration date of this permit, the permittee must apply for and obtain a new permit except as provided in 1.6 and 1.7 of this permit.

5.3. Need to Halt or Reduce Activity not a Defense. It shall not be a defense for a permittee in an enforcement action that it would have been necessary to halt or reduce the permitted activity in order to maintain compliance with the conditions of this permit.

5.4. Duty to Mitigate. The permittee shall take all reasonable steps to minimize or prevent any discharge in violation of this permit that has a reasonable likelihood of adversely affecting human health or the environment.

5.5. Duty to Provide Information. The permittee shall furnish to the Director or an authorized representative, within a reasonable time, any information that is requested to determine compliance with this permit. The permittee must also furnish to the Director or an authorized representative copies of records to be kept by this permit.

5.6. Other Information. When the permittee becomes aware that he or she failed to submit any relevant facts or submitted incorrect information in the NOI or in any other report to the Director, he or she shall promptly submit such facts or information.

General Storm Water Permit for Construction Activity Connected with Single Lot Housing Projects
UPDES Permit No. UTRH00000

- 5.7. Oil and Hazardous Substance Liability. Nothing in this permit shall be construed to preclude the institution of any legal action or relieve the permittee from any responsibilities, liabilities, or penalties to which the permittee is or may be subject under the Act.
- 5.8. Property Rights. The issuance of this permit does not convey any property rights of any sort, nor any exclusive privileges, nor does it authorize any injury to private property nor any invasion of personal rights, nor any infringement of Federal, State or local laws or regulations.
- 5.9. Severability. The provisions of this permit are severable, and if any provision of this permit, or the application of any provision of this permit to any circumstance, is held invalid, the application of such provision to other circumstances, and the remainder of this permit shall not be affected thereby.
- 5.10. Record Retention. The permittee shall retain copies of SWPPPs and all reports required by this permit, and records of all data used to complete the NOI to be covered by this permit, for a period of at least three years from the date that the permit for the site is terminated (see 3.7). This period may be extended by request of the Director at any time.
- 5.11. Addresses. All written correspondence under this permit shall be directed to the DWQ at the following address:
- Department of Environmental Quality
Division of Water Quality
195 North 1950 West
P.O. Box 144870
Salt Lake City, Utah 84114-4870
- 5.12. State Laws. Nothing in this permit shall be construed to preclude the institution of any legal action or relieve the permittee from any responsibilities, liabilities, or penalties established pursuant to any applicable State law or regulation under authority preserved by Utah Code Annotated 19-5-117.
- 5.12.1. No condition of this permit shall release the permittee from any responsibility or requirements under other environmental statutes or regulations.
- 5.13. Proper Operation and Maintenance. The permittee shall at all times properly operate and maintain all facilities and systems of treatment and control and related appurtenances which are installed or used by the permittee to achieve compliance with the conditions of this permit and with the requirements of SWPPPs. Proper operation and maintenance also includes adequate laboratory controls and appropriate quality assurance procedures. Proper operation and maintenance requires the operation of backup or auxiliary facilities or similar systems, installed by a permittee only when necessary to achieve compliance with the condition of the permit.
- 5.14. Inspection and Entry. The permittee shall allow, upon presentation of credentials, the Director or an authorized representative to:
- 5.14.1. Enter upon the permittee's premises where a regulated facility or activity is located or conducted or where records must be kept under the conditions of this permit;

General Storm Water Permit for Construction Activity Connected with Single Lot Housing Projects
UPDES Permit No. UTRH00000

- 5.14.2. Have access to and copy at reasonable times, any records that must be kept under the conditions of this permit.
- 5.14.3. Inspect at reasonable times any facilities, equipment (including monitoring and control equipment), practices or operations regulated or required under this permit; and
- 5.14.4. Sample or monitor at reasonable times for the purposes of assuring permit compliance or as otherwise authorized by law, any substances or parameters at any location.

5.15. Reopener Clause.

- 5.15.1. *Reopener Due to Water Quality Impacts.* If there is evidence indicating that the storm water discharges authorized by this permit cause, have the reasonable potential to cause, or contribute to a violation of a water-quality standard, the discharger may be required to obtain an individual permit or an alternative general permit in accordance with 1.7.4 of this permit or the permit may be modified to include different limitations and/or requirements.
- 5.15.2. *Reopener Guidelines.* Permit modification or revocation will be conducted according to Utah Administrative Code R317-8-5.6 and UAC R317-8-6.2.
- 5.15.3. *Permit Actions.* This permit may be modified, revoked and reissued, or terminated for cause. The filing of a request by the permittee for a permit modification revocation and reissuance, termination, a modification of planned changes or anticipated noncompliance does not stay any permit condition.

5.16. Signatory Requirements.

- 5.16.1. All NOIs, SWPPPs, reports, certifications or information submitted to the Director, or that this permit requires be maintained by the permittee, shall be signed as follows:
 - 5.16.1.a. All NOIs and SWPPPs shall be signed by both the owner or lessee of the project/property and the general contractor.
 - 5.16.1.b. All reports required by the permit and other information requested by the Director or by an authorized representative of the Director shall be signed by a person described above or by a duly authorized representative of that person. A person is a duly authorized representative only if:
 - 5.16.1.b.i. The authorization is made in writing by a person described above and submitted to the Director; and
 - 5.16.1.b.ii. The authorization specifies either an individual or a position having such as the position of manager, operator, superintendent, or position of equivalent responsibility or an individual or position having overall responsibility for environmental matters for the company. A duly authorized representative may therefore be either a named individual or any individual occupying a named position.
 - 5.16.1.c. *Certification.* Any person signing documents under 5.16 shall make the following certification:

General Storm Water Permit for Construction Activity Connected with Single Lot Housing Projects
UPDES Permit No. UTRH00000

I certify under penalty of law that this document and all attachments were prepared under my direction or supervision in accordance with a system designed to assure that qualified personnel properly gathered and evaluated the information submitted. Based on my inquiry of the person or persons who manage the system, or those persons directly responsible for gathering the information, the information submitted is, to the best of my knowledge and belief, true, accurate, and complete. I am aware that there are significant penalties for submitting false information including the possibility of fine and imprisonment for knowing violations.

- 5.16.2. If a document is to be signed electronically, the Division's rules regarding electronic transactions govern, if applicable.

6. DEFINITIONS

Arid Areas: Areas with an average annual rainfall of 10 inches or less.

Common Plan of Development (or sale): A plan to subdivide a parcel of land into separate parts for separate sale. This can be for a residential, commercial, or industrial development. The plan originates as a single parcel that is separated into parts. This usually goes through an approval process by a local governmental unit, but in some cases, it may not require that process. The original plan is considered the "common plan of development or sale" whether phased or completed in steps.

Additional information related to *Common Plan of Development for Permit Purposes:*

For UPDES storm water permit purposes, a common plan must have been initiated after October, 1992. A common plan of development or sale remains so until each lot or section of the development has fulfilled its planned purposes (e.g. in a residential development as homes are completed, stabilized, and sold or occupied). As lots or separated sections of the development are completed, the lot or section is stabilized, and the plan purposes are fulfilled for that area, lot, or section, it is no longer part of the common plan of development or sale (e.g. if a home is sold in a development and the owner decides to add a garage somewhere on the lot, that garage project is not part of the common plan of development or sale).

In this process a common plan of development or sale may become reduced in size and/or separated by completed areas which are no longer part of the common plan of development or sale, but all unfinished lots remain part of the same common plan development or sale until they are completed, stabilized, and fulfilled according to the purposes of the plan.

Construction Activity: Earth-disturbing activities, such as the clearing, grading, and excavation of land.

Construction Waste: Discarded material such as packaging materials, scrap construction materials, masonry products, timber, steel, pipe, and electrical cuttings, plastics, and Styrofoam.

Corrective Action: For the purposes of the permit, any action taken to 1) repair, modify, or replace any storm water control used at the site; 2) clean up and dispose of spills, releases, or other deposits found on the site; and 3) remedy a permit violation.

Dewatering: The act of draining rainwater and/or groundwater from building foundations, vaults, and trenches (Note: if dewatering is occurring on a construction site and it causes a discharge to waters of the State, it must be permitted separately under the General Permit for Construction Dewatering and Hydrostatic Testing , UPDES Permit UTG070000).

Director: The director of the Division of Water Quality.

Discharge Point: For the purposes of this permit, the location where collected and concentrated storm water flows are discharged from the construction site.

Final Stabilization: All disturbed areas must be covered by permanent structures such as pavement, concrete slab, building, etc., or for areas not covered by permanent structures but that are receiving 20 inches or more of average annual precipitation, vegetation has been established with a uniform (e.g.,

General Storm Water Permit for Construction Activity Connected with Single Lot Housing Projects
UPDES Permit No. UTRH00000

evenly distributed, without large bare areas) perennial vegetative cover equivalent to 70 percent of the natural background vegetative cover. In the case of areas that are not covered by permanent structures, but that are receiving less than 20 inches of average annual precipitation (arid areas, 0-10 inches; semi-arid areas, 10-20 inches), final stabilization is equivalent to the requirements of 2.6.3 of this permit, including the provisions for permanent stabilization.

Impervious Surface: For the purpose of this permit, any land surface with a low or no capacity for water infiltration including, but not limited to, pavement, sidewalks, parking areas, driveways, or rooftops.

Indian Country: Defined at 40 CFR §122.2 as follows:

1. All land within the limits of any Indian reservation under the jurisdiction of the United States Government, notwithstanding the issuance of any patent, and, including rights-of-way running through the reservation;
2. All dependent Indian communities within the borders of the United States whether within the originally or subsequently acquired territory thereof; and
3. All Indian allotments, the Indian titles to which have not been extinguished, including rights-of-ways running through the same.

Infeasible: Infeasible means not technologically possible or not economically practicable and achievable in light of best industry practices. DWQ notes that it is not intentional for permit storm water control efforts required in the permit to conflict with State water rights law. In the case of conflict, State water rights law supersedes.

Install or Installation: When used in connection with storm water controls, to connect or set in position storm water controls to make them operational.

Municipal Separate Storm Sewer System or MS4: A storm-sewer system owned and operated by a state, city, town, county, district, association, or other public body created by or pursuant to State law having jurisdiction over disposal of storm water that discharges to waters of the State (e.g., Sandy City owns and operates the MS4 within the jurisdiction of Sandy City, or essentially Sandy City is the MS4).

Natural Buffer: For the purposes of this permit, an area of undisturbed natural cover surrounding surface waters within which construction activities are restricted. Natural cover includes the vegetation, exposed rock, or barren ground that exists before earth-disturbing activities begin.

Oversight Authority: Oversight authorities for storm water permits are agents from the EPA, DWQ or the Municipality of jurisdiction, when they are addressing compliance of storm water permits.

Owner: For the purpose of this permit an owner has ownership of a property on which construction activity is taking place, but it also includes ownership of a project for which construction activity is occurring on property that is leased. An owner is the party that has ultimate control over construction plans and specifications, including the ability at the highest level to make modifications to those plans and specifications. "Owner" in this context is the party that has ultimate control over the destiny of a project.

Permittee: The owner and/or the general contractor (those that signed on the NOI), for the project.

General Storm Water Permit for Construction Activity Connected with Single Lot Housing Projects
UPDES Permit No. UTRH00000

Pollutant-Generating Activities: At construction sites, for the purposes of this permit, those activities that lead to or could lead to the generation of pollutants, either as a result of earth-disturbance or a related support activity. Some of the types of pollutants that are typically found at construction sites are as follows:

- Sediment
- Nutrients
- Heavy metals
- Pesticides and herbicides
- Oil and grease
- Bacteria and viruses
- Trash, debris, and solids
- Treatment polymers
- Any other toxic chemicals

Pollution Prevention Measures: Storm water controls designed to reduce or eliminate the addition of pollutants to construction site discharges through analysis of pollutant sources, implementation of proper handling/disposal practices, employee education, and other actions.

Project Site: A project site is not necessarily contained within the property boundaries designated for the final construction objective, or property owned by the owner of the project. The project site includes all areas affected by the construction process where disturbances, storage, or other construction activity occurs. If an area outside of property boundaries is used for the construction process, DWQ assumes the permittee has the right to access and use that area and the permittee must also meet permit requirements in that area.

Receiving Water: A "Water(s) of the State" is as defined in UAC R317-1-1, into which the regulated storm water discharges (see waters of the State listed below).

Rumble Strip: A rigid ramp/track (often made of steel) that vehicles drive over that causes tires to flex and shake for the removal of dirt.

Semi-Arid Areas: Areas with an average annual rainfall of between 10 and 20 inches.

Stabilization: The use of vegetative and/or non-vegetative cover to prevent erosion and sediment loss in areas of disturbed soil exposed from the construction process.

Storm water: Means storm water runoff, snowmelt runoff, and surface runoff and drainage.

Storm Water Control Measures: Refers to any storm water control, BMP, or other method used to prevent or reduce the discharge of pollutants to waters of the state.

General Storm Water Permit for Construction Activity Connected with Single Lot Housing Projects
UPDES Permit No. UTRH00000

Storm Water Inlet: An entrance or opening to a storm water conveyance system, generally placed below grade so as to receive storm water drainage from the surrounding area.

Storm Event: A precipitation event that results in a measurable amount of precipitation.

Track Out Pad: A track out pad is a pad normally made up of 4 to 6 inches of up to 6 inch cobble rocks or gravel of various size (the size is sometimes specified by a local MS4). Sometimes it is underlain with a fabric to keep dirt and mud separated from rock or gravel. It is wide enough to underlay the tires of any/all traffic leaving a construction site as vehicles exit the site. Its function is to flex and shake the tires to dislodge mud and dirt from the tires of vehicles leaving the construction site. Track out pads must be stirred or worked periodically so that mud or dirt collected is moved to the bottom and the rock/gravel on the pad is clean and effective dislodging more mud/dirt.

Waters of the State: All streams, lakes, ponds, marshes, watercourses, waterways, wells, springs, irrigation systems, drainage systems, and all other bodies or accumulations of water, surface and underground, natural or artificial, public or private, that are contained within, flow through, or border upon this state or any portion thereof, except that bodies of water confined to and retained within the limits of private property, and that do not develop into or constitute a nuisance, or a public health hazard, or a menace to fish and wildlife, shall not be considered to be "Waters of the State" under this definition (see Utah Code Annotated, 19-5-102(23)(a) &(b), and UAC R317-1-1).

APPENDIX C: Notice of Intent and Termination.

Find the Notice of Termination Form at
<https://deg.utah.gov/Permits/water/updes/stormwatercon.htm>

However, termination of the project can be done on-line at <https://secure.utah.gov/stormwater>
(You must log in using the same username that you applied for your NOI with. If you completed a paper NOI you must complete a paper NOT.)

APPENDIX D: Daily Self-Inspection Log (permit part 3.2.2).

APPENDIX E: Inspection Reports

SWPPP Appendices

Ensure the following documentation is attached to the SWPPP:

Appendix A: SWPPP Site Maps

Appendix B: Common Plan Permit

Appendix C: Notice of Intent (NOI), and a copy of the NOT form unless you plan to terminate the permit on-line

Appendix D: Daily Site Check Log

Appendix E: Inspection Reports and Corrective Actions

Appendix F: Additional Information (i.e. permits such as local permits, dewatering, stream alteration, wetland, and out of date SWPPP documents, delegation of authority forms, etc.)

Appendix G: BMP Specifications and Details (label BMPs to match the sections identified in this document.)

APPENDIX A: SWPPP Site Maps

NOTES:
 1- ALL DIMENSIONS ARE IN FEET
 2- SEE ALL SHEETS FOR DIMENSIONS
 3- DIMENSIONS ARE TO FACE UNLESS NOTED OTHERWISE
 4- DIMENSIONS ARE TO CENTERLINE UNLESS NOTED OTHERWISE

---	LINE LEADER
---	PROPERTY LINES
---	EXISTING

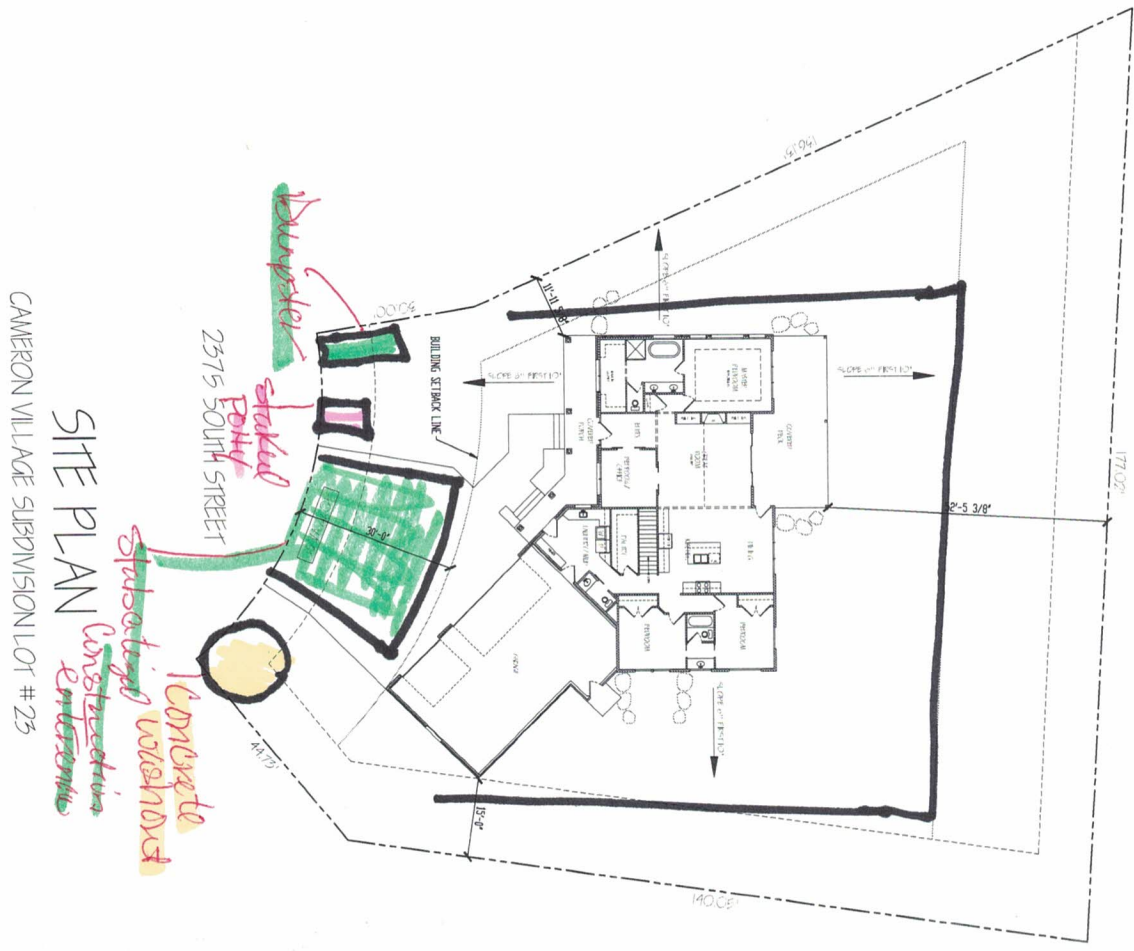

CAMERON VILLAGE SUBDIVISION LOT # 25

SITE PLAN

Concrete Washout
 Storage
 Porta John

WASHOUT

- 1-who will be responsible for the site conditions of site during construction? *Wendy Lantis*
- 2- What will be done to prevent the neighbors from being affected? Silt Fence or Berm as needed.
- 3-What will be done with all excavated material temporarily and permanently? All materials will stay on site
- 4-Where is the concrete washout and how will it be maintained? Concrete washout will be located on front corner of lot
- 5- Where is the porta John located? Restroom will be placed on front Corner of lot
- 6- How and where will the construction entrance be built? Sand, gravel, rock will be placed at the front entrance.
- 7-what will you do when mud and or dirt gets tracked on the asphalt? sweep
- 8- What currently happens to the rain/storm water when it reaches the project site? Trench will be built along property lines to prevent storm water from entering adjacent lots if necessary
- 9-No existing occupation on property.

SHEET 5	DATE: 08/11/19	PREPARED BY GEORGENE BRINKERHOFF RESIDENCE 4077 WEST 2375 SOUTH WEBER COUNTY, UTAH	T & C DESIGN 4497 WEST 1600 NORTH PLAIN CITY, UT 84404	COMMENTS ALL WORK IS TO BE CONSISTENT WITH THE BEST BUILDING PRACTICES AND CONFORM TO ALL BUILDING CODE REQUIREMENTS. THE CONTRACTOR SHALL VERIFY ALL DIMENSIONS AND CONDITIONS PRIOR TO STARTING CONSTRUCTION.	SCALE: 1/8"=1'
---------	-------------------	---	---	---	----------------

APPENDIX F: Additional Information

For permits such as local permits, dewatering, stream alteration, wetland, and out of date SWPPP documents, delegation of authority forms, etc.

Delegation of Authority

I, Mike Alvord ; _____, hereby designate the person or specifically described position below to be a duly authorized representative for the purpose of overseeing compliance with environmental requirements, including the Common Plan Permit, at the Lot 311 Willow Flats construction site. The designee is authorized to sign any reports, storm water pollution prevention plans and all other documents required by the permit.

Wendy Lallis

Mac Builders

735 W 2400 S

Syracuse , Ut 84075

(801)773-4439)

By signing this authorization, I confirm that I meet the requirements to make such a designation as set forth in UTRH00000 , and that the designee above meets the definition of a “duly authorized representative” as set forth in UTRH00000 .

I certify under penalty of law that this document and all attachments were prepared under my direction or supervision in accordance with a system designed to assure that qualified personnel properly gathered and evaluated the information submitted. Based on my inquiry of the person or persons who manage the system, or those persons directly responsible for gathering the information, the information submitted is, to the best of my knowledge and belief, true, accurate, and complete. I am aware that there are significant penalties for submitting false information, including the possibility of fine and imprisonment for knowing violations.

Name: Mike Alvord

Company: Mac Builders

Title: Owner

Signature: 

Date: 10/30/2019

APPENDIX G: BMP Specifications and Details

Label BMPs to match the sections identified in this document.

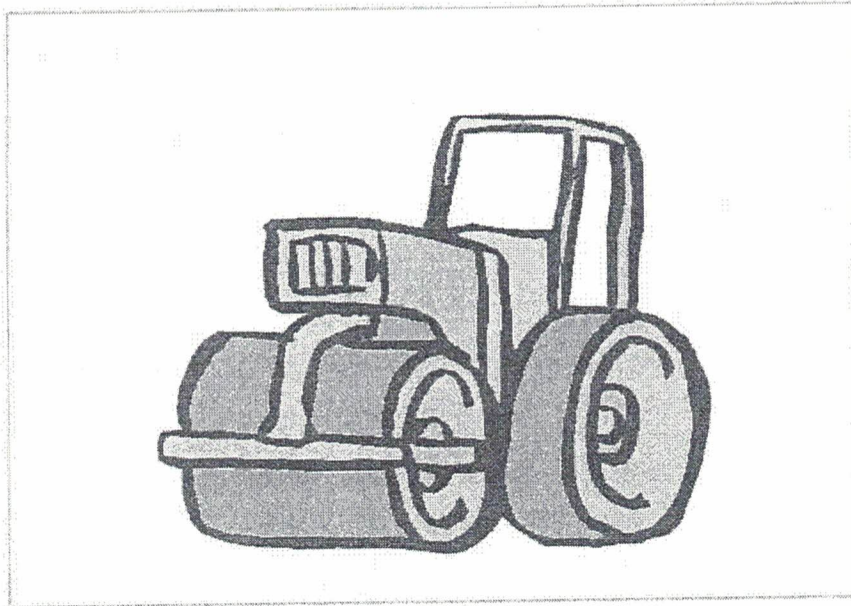
**DESCRIPTION:**

Use of rolling, tamping, or vibration to stabilize fill materials and control erosion by increasing the soil density. Increasing the density of soil improves soil strength, reduces long-term soil settlement, and provides resistance to erosion.

APPLICATIONS:

- ◆ Stabilize fill material placed around various structures.
- ◆ Improve soil in place as foundation support for roads, parking lots, and buildings.

INSTALLATION/APPLICATION CRITERIA:

- ◆ Make sure soil moisture content is at optimum levels.
- ◆ Use proper compaction equipment.
- ◆ Install sediment control and storm water management devices below compacted areas and runoff interceptor devices above these areas. Drainage from compacted areas must be carefully planned to protect adjacent uncompacted soils.
- ◆ The surface of compacted areas should be scarified and seeded or mulched and seeded to increase the effectiveness of compaction.

LIMITATIONS:

- ◆ Compaction tends to increase runoff.
- ◆ Over-compaction will hamper revegetation efforts.

MAINTENANCE:

- ◆ No maintenance required.

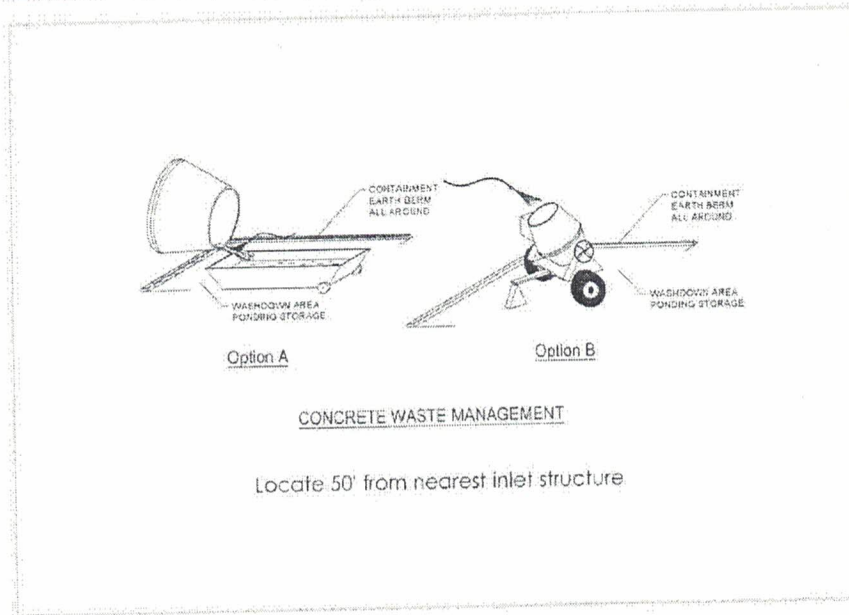

DESCRIPTION:

Prevent or reduce the discharge of pollutants to storm water from concrete waste by conducting washout off-site, performing on-site washout in a designated area, and training employees and subcontractors.

APPLICATION:

This technique is applicable to all types of sites.

INSTALLATION/APPLICATION CRITERIA:

- ◆ Store dry materials under cover, away from drainage areas.
- ◆ Minimize excess mixing of fresh concrete, mortar or cement on-site.
- ◆ Perform washout of concrete trucks off-site or in designated areas only.
- ◆ Do not wash out concrete trucks into storm drains, open ditches, streets, or streams.
- ◆ Do not allow excess concrete to be dumped on-site, except in designated areas.
- ◆ When washing concrete to remove fine particles and expose the aggregate, avoid creating runoff by draining the water within a bermed or level area. (6" tall by 6" wide).
- ◆ Train employees and subcontractors in proper concrete waste management.

LIMITATIONS:

- ◆ Off-site washout of concrete wastes may not always be possible.

MAINTENANCE:

- ◆ Inspect subcontractors to ensure that concrete wastes are being properly managed.
- ◆ If using a temporary pit, dispose hardened concrete on a regular basis.

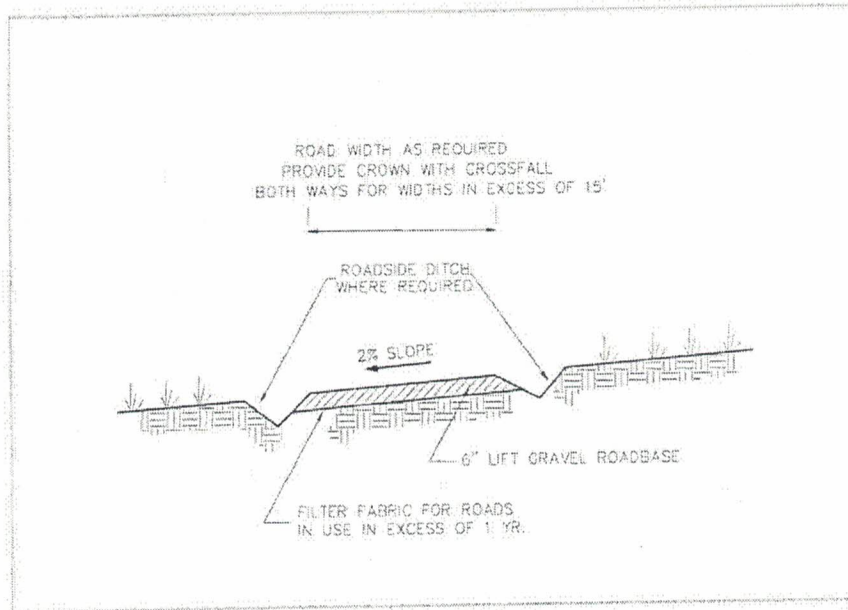

DESCRIPTION:

Temporary stabilization of on-site roadway by placement of gravel roadbase.

APPLICATION:

- ◆ On-site roadways used daily by construction traffic (may not apply to gravelly type soils).
- ◆ Parking or staging areas susceptible to erosion due to traffic use.

INSTALLATION/APPLICATION CRITERIA:

- ◆ Grade temporary access road with 2% cross fall, for two-way width provide crown.
- ◆ Provide roadside ditch and outlet controls where required.
- ◆ Place 6 inches of 2-inch to 4-inch crushed rock on driving area.

LIMITATIONS:

- ◆ May require removal of gravel roadbase at completion of activities if final cover is not impervious.
- ◆ May require controls for surface storm water runoff.

MAINTENANCE:

- ◆ Inspect after major rainfall events and at least monthly.
- ◆ Place additional gravel as needed and repair any damaged areas.
- ◆ Maintain any roadside drainage controls.

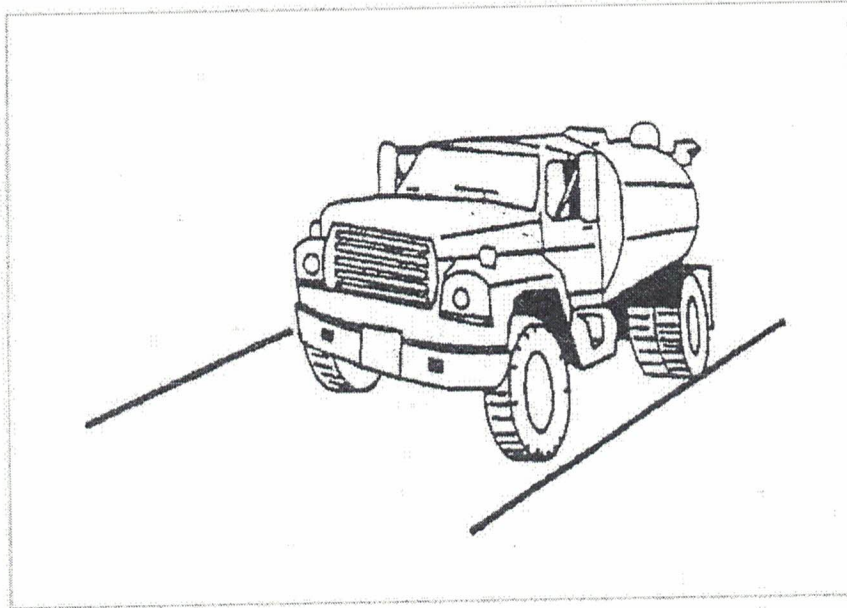
**DESCRIPTION:**

Dust control measures are used to stabilize soil from wind erosion, and reduce dust by construction activities.

APPLICATION:

Dust control is useful in any process area, loading and unloading area, material handling areas, and transfer areas where dust is generated. Street sweeping is limited to areas that are paved.

INSTALLATION/APPLICATION CRITERIA:

- ◆ Mechanical dust collection systems are designed according to the size of dust particles and the amount of air to be processed. Manufacturers' recommendations should be followed for installation (as well as the design of the equipment).
- ◆ Two kinds of street sweepers are common: brush and vacuum. Vacuum sweepers are more efficient and work best when the area is dry.
- ◆ Mechanical equipment should be operated according to the manufacturers' recommendations and should be inspected regularly.

LIMITATIONS:

- ◆ Generally more expensive than manual systems.
- ◆ May be impossible to maintain by plant personnel (the more elaborate equipment).
- ◆ Labor and equipment intensive and may not be effective for all pollutants (street sweepers).

MAINTENANCE:

If water sprayers are used, dust-contaminated waters should be collected and taken for treatment. Areas will probably need to be resprayed to keep dust from spreading.

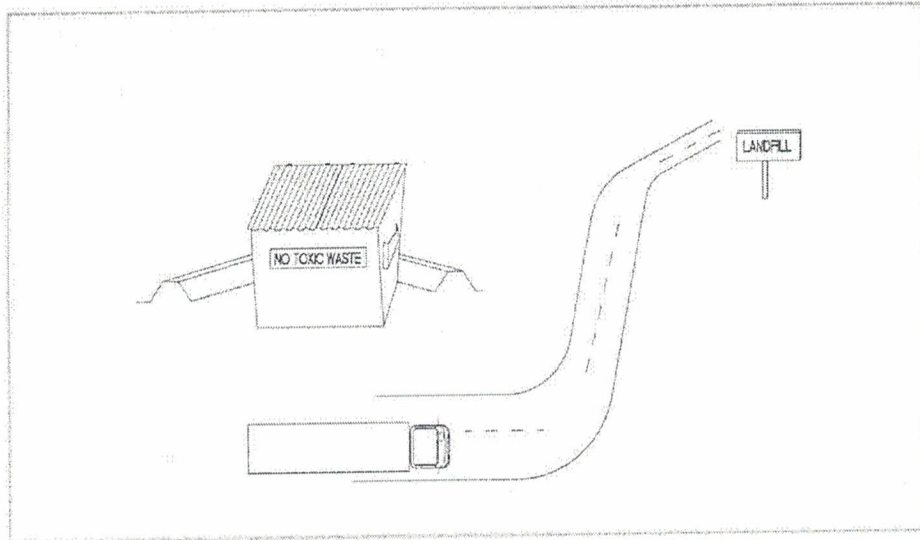

DESCRIPTION:
Controlled storage and disposal of solid waste generated by construction activities.

APPLICATION:
All construction sites.

- INSTALLATION:**
- ◆ Designate one or several waste collection areas with easy access for construction vehicles and personnel. Ensure no waterways or storm drainage inlets are located near the waste collection areas.
 - ◆ Construct compacted earthen berm (See Earth Berm Barrier Information Sheet), or similar perimeter containment around collection area for impoundment in the case of spills and to trap any windblown trash.
 - ◆ Use watertight containers with covers to remain closed when not in use. Provide separate containers for different waste types where appropriate and label clearly.
 - ◆ Ensure all on site personnel are aware of and utilize designated waste collection area properly and for intended use only (e.g. all toxic, hazardous, or recyclable materials shall be properly disposed of separately from general construction waste).
 - ◆ Arrange for periodic pickup, transfer and disposal of collected waste at an authorized disposal location. Include regular Porta-potty service in waste management activities.

- LIMITATIONS:**
- ◆ On-site personnel are responsible for correct disposal of waste.

- MAINTENANCE:**
- ◆ Discuss waste management procedures at progress meetings.
 - ◆ Collect site trash daily and deposit in covered containers at designated collection areas.
 - ◆ Check containers for leakage or inadequate covers and replace as needed.
 - ◆ Randomly check disposed materials for any unauthorized waste (e.g. toxic materials).
 - ◆ During daily site inspections check that waste is not being incorrectly disposed of on-site (e.g. burial, burning, surface discharge, discharge to storm drain).

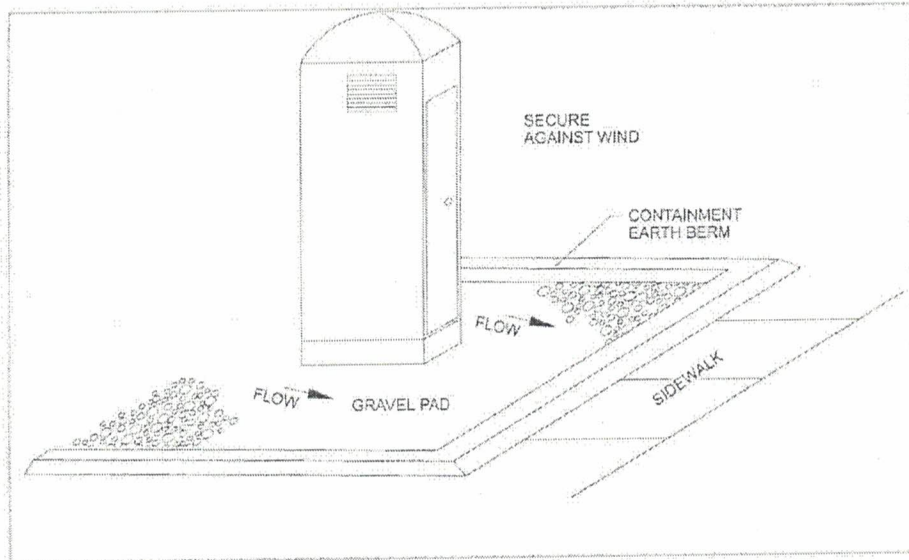

DESCRIPTION:

Temporary on-site sanitary facilities for construction personnel.

APPLICATION:

All sites with no permanent sanitary facilities or where permanent facility is too far from activities.

INSTALLATION/APPLICATION CRITERIA:

- ◆ Locate portable toilets in convenient locations throughout the site.
- ◆ Prepare level, gravel surface and provide clear access to the toilets for servicing and for on-site personnel.
- ◆ Construct earth berm perimeter (6" tall by 6" wide), control for spill/protection leak.

LIMITATIONS:

- ◆ No limitations.

MAINTENANCE:

- ◆ Portable toilets should be maintained in good working order by licensed service with daily observation for leak detection.
- ◆ Regular waste collection should be arranged with licensed service.
- ◆ All waste should be deposited in sanitary sewer system for treatment with appropriate agency approval.