



**REEVE & ASSOCIATES, INC.**

3670 Quincy Ave., Suite #1  
Ogden, Utah 84403  
(801) 621-3100 • FAX (801) 621-2666

JOB EDGEWATER BEACH RESORT

SHEET NO. PHASE 1 OF \_\_\_\_\_

CALCULATED BY \_\_\_\_\_ DATE \_\_\_\_\_

CHECKED BY \_\_\_\_\_ DATE \_\_\_\_\_

INCLUDED WITH THIS DOCUMENT ARE THE FOLLOWING ITEMS:

1. GREAT BASIN CALC. FOR THE EXISTING PUMP STATION SIZING.
2. REVISED CALC. FOR ADMENDED PHASE ONE.
3. EXISTING PUMP INFO.
4. PROPOSED BACKUP GENERATOR  
(GENERATOR WILL BE REUSED FOR 2<sup>ND</sup> PHASE & TOTAL PROJECT DEMAND) SEE SPEC SHEET.
5. PROPOSED FIBERGLASS TANK WILL PROVIDE ADDITIONAL BACKUP CAPACITY REQUIRED BY SEWER DISTRICT. (WILL BE REUSED) SEE DETAIL.

**RECEIVED**

By Michael Tuttle at 3:04 pm, Aug 19, 2013



**GREAT BASIN  
ENGINEERING, INC. - NORTH**

Ogden, UT.  
Ogden (801) 394-4515 Fax (801) 392-7544

JOB EDENWATER BEACH RESORT  
SHEET NO. \_\_\_\_\_ OF \_\_\_\_\_  
CALCULATED BY \_\_\_\_\_ DATE \_\_\_\_\_  
CHECKED BY \_\_\_\_\_ DATE \_\_\_\_\_  
SCALE \_\_\_\_\_

Temporary Lift Station

Wet Well Design

5' dia. Manhole - 4' below  $\mathbb{E}$

$$19.64 \text{ sf} \times 4 = 78.54 \text{ cf}$$

$$= 587.5 \text{ gallons}$$

Design Discharge Rate Per Unit

@  $400 \text{ gpd} \times 4 \text{ units}$  (phase I)  
 $= 1600 \text{ gpd}$   
 Avg Flow Rate =  $1.11 \text{ gpm}$   
 Peak Flow Rate  $4 \times 1.11 \text{ gpm} = 4.44 \text{ gpm}$

Practical cycling of Pumps - 4 to 8 times per day

Pump time @  $50 \text{ gpm}$  for 500 gallon = 10 min

Duplex Pumping system - capable of pumping  $100 \text{ gpm}$  with both pumps operating

\* Wet Well Size to avoid heat build up in pumps (frequent starting) and septic conditions due to excessive detention time.

$400 \text{ gpd}$  per connection is state design standard - Our water studies have shown that sewage generation of units when occupied is less than  $150 \text{ gallons per day per connection}$ .

\* Based on this data there is a minimum 24 hour storage for 4 units or 12 hour storage for 8 units.

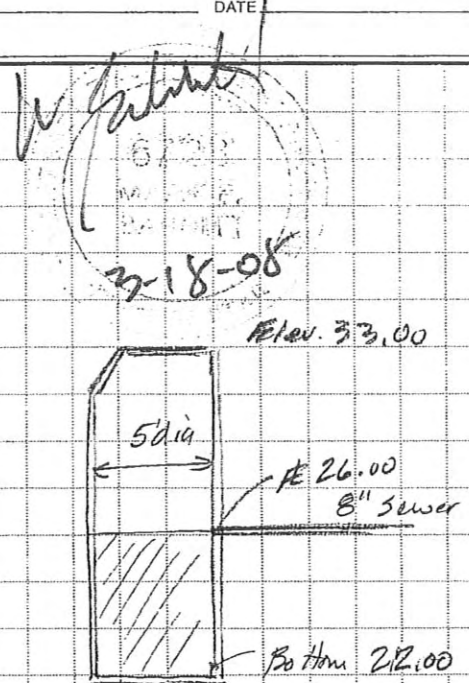



# REEVE & ASSOCIATES, INC.

Ogden Office  
 4155 S. Harrison Blvd. #310 Ogden, Utah 84403  
 (801) 621-3100 FAX (801) 621-2666

Logan Office  
 95 West 100 South, Ste.310 Logan, Utah 84321  
 (435) 752-3303 FAX (435) 752-2266

JOB EDGEWATER EST. PHASE I  
 SHEET NO. REVISED OF \_\_\_\_\_  
 CALCULATED BY \_\_\_\_\_ DATE \_\_\_\_\_  
 CHECKED BY \_\_\_\_\_ DATE \_\_\_\_\_

## REVISED FIRST PHASE SANITARY SEWER DISCHARGE RATE

4 PLEX 4x400	=	1600 gpd
9 UNITS 9x400	=	3600 "
POOL HSE (50 PEOPLE)	=	500 "
6 COMM. UNITS (40 PEOPLE/UNIT)	=	2400 "
		<u>8100 gpd</u> = 5.63 gpm AVERAGE
PEAK FLOW RATE	$5.63 \times 4$	= 22.5 gpm

WET WELL CAPACITY = 587.5 GALLONS  
 CYCLE TIME FOR PUMPS =  $587.5 / 5.63 = 104$  min. AVERAGE  
 $587.5 / 22.5 = 26.11$  min. PEAK

EXIST. PUMPS (2) 50 GPM

ADDITIONAL PUMPS REQUIRED

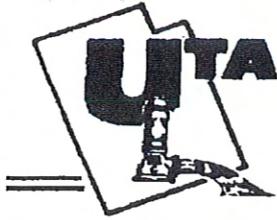
**UTAH Pump & Motor Supply Co.**

PUMPS - MOTORS - CONTROLS

PO Box 95406 South Jordan UT 84095 (801) 302-0333

### Fax Transmission

To: Mike Serio  
Company: Serio Construction  
Fax #: 1-801-745-0263  
From: Phil Poole  
Pages: 5  
Re: Lift Station at Edgewater Beach Resort  
Date: February 11, 2008

Dear Mike,

In this packet, you will find the technical information on the lift station at Edgewater Beach Resort at Huntsville, Utah. As you know, the sump was designed and installed by others<sup>who</sup> as well as the gravity line and the force main.

There are two (2) 2 HP single phase freestanding pumps now installed in the sump. They are Omnivore brand grinder pumps model #LSG202M. They are 2.0 HP, 1 Phase, 230 Volt pumps rated at 50 GPM @ 40' TDH, all technical information including performance curve is included in the packet. The pumps each discharge into a 2" force main including a ball isolation and ball check valve on each discharge line as well as threaded unions for ease of service. The lines merge into the 2" force main provided by others with a cleanout and thrust block included in the appurtenances.

The control panel is a Rhombus model 112 utilizing float level and alarm switches also installed in the sump. A spec sheet on the control panel is also enclosed.

I hope this information is helpful.

Sincerely,

  
Phil Poole

# MODEL 112 Control Panel

CONTROL PANELS

Single phase, simplex motor contactor control.

The Model 112 control panel provides a reliable means of controlling one 120, 208, or 240 VAC single phase pump in pump chambers, sump pump basins, irrigation systems and lift stations. Two control switches activate a magnetic motor contactor to turn the pump on and off. If an alarm condition occurs, an additional alarm switch activates the audio/visual alarm system.

## PANEL COMPONENTS

1. Enclosure measures 8 x 8 x 4 inches (20.32 X 20.32 X 10.16 cm). Choice of NEMA 1 (steel for indoor use), or NEMA 4X (ultraviolet stabilized thermoplastic with removable mounting feet for outdoor or indoor use).  
\* Options selected may increase enclosure size and change component layout.
2. Magnetic Motor Contactor controls pump by switching electrical lines.
3. HOA Switch for manual pump control (mounted on circuit board).
4. Green Pump Run Indicator Light (mounted on circuit board).
5. Float Switch Terminal Block (mounted on circuit board).
6. Alarm and Control Fuses (mounted on circuit board).
7. Alarm and Control Power Indicators (mounted on circuit board).
8. Ground Lug
9. Circuit Breaker (optional) provides pump disconnect and branch circuit protection.

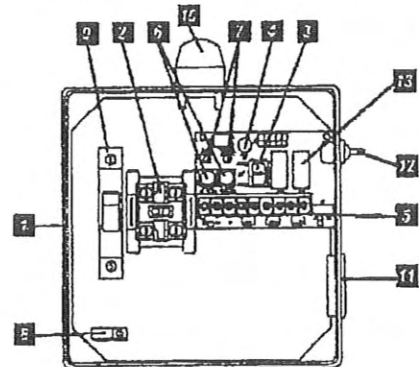

Model Shown 1121W914X

## STANDARD ALARM PACKAGE

10. Red Alarm Beacon provides 360° visual check of alarm condition.  
Note: NEMA 1 style utilizes a door mounted indicator in lieu of a beacon.
11. Alarm Horn provides audio warning of alarm condition (83 to 85 decibel rating).  
Note: NEMA 1 style utilizes an internally mounted buzzer in lieu of horn.
12. Exterior Alarm Test/Normal/Silence Switch allows horn and light to be tested and horn to be silenced in an alarm condition. Alarm automatically resets once alarm condition has been cleared.
13. Horn Silence Relay (mounted on circuit board).

NOTE: other options available.

## FEATURES

- Entire control system (panel and switches) is UL Listed to meet and/or exceed industry safety standards
- Dual safety certification for the United States and Canada
- Standard package includes three 20' Sensor Float® control switches
- Complete with step-by-step installation instructions
- Three-year limited warranty



**SJE**  
**Rhombus**  
CONTROLS

PO Box 1708, Detroit Lakes, MN 56502  
1-888-DIAL-SJE • 1-218-847-1317  
1-218-847-4617 Fax  
email: sje@sjerhombus.com  
[www.sjerhombus.com](http://www.sjerhombus.com)

SEE BACKSIDE FOR COMPLETE LISTING OF AVAILABLE OPTIONS.



Liberty's LSG200-Series Grinder Pumps meet the demanding needs of commercial and residential sewage applications where difficult solids-handling ability is crucial. The LSG200-Series features a superior cutting system made of hardened 440 stainless steel - Rockwell C 58, for shearing solids into small particles prior to being passed to the discharge by the impeller under high pressure. Applications include individual or groups of homes, motels, schools, shopping centers, lakefront developments and systems requiring high pressure sewage pumping.

## LSG200-Series Grinder Pumps

### Features:

- 2 hp, heavy-duty motor - oil filled, thermally protected
- Upper and lower ball bearings
- One-piece uni-body cast iron housing
- 300 Series SS Rotor Shaft
- 316 Stainless steel impeller
- Dual seals - Upper seal is unitized durable silicon carbide. Lower seal is Viton® double-lip. (Lower seal ensures that all debris is kept away from main seal)
- Motor windings insulated to Class B (130°C)
- Advanced V-Slice™ cutting system made of hardened 440 stainless steel - Rockwell C 58
- Horizontal 1-1/4" FNPT Discharge
- Back vanes on impeller and spiraled bottom plate for superior solids clearing
- All stainless steel fasteners
- Clog-free volute design
- Designed for maximum heat dissipation and cool motor operating temperatures
- Solid state starting circuit - no mechanical relay coil
- 25' power cord with Quick-Disconnect
- Piggy back plug with wide angle float (on automatic model) eliminates need for expensive panel

Viton® is a registered trademark of DuPont Dow Elastomers LLC.



**NEW!**

## V-Slice™ Technology

Superior cutting system provides improved shredding performance over radial cutters. V-pattern provides up to 108 alternated cuts per revolution. Entire cutting system made of 440 stainless steel hardened to 58 Rc.

Recessed cutter bolt eliminates wadding

Exclusion cleanout slots and back relief clears debris from under cutter

immo

# LSG200-Series Specifications

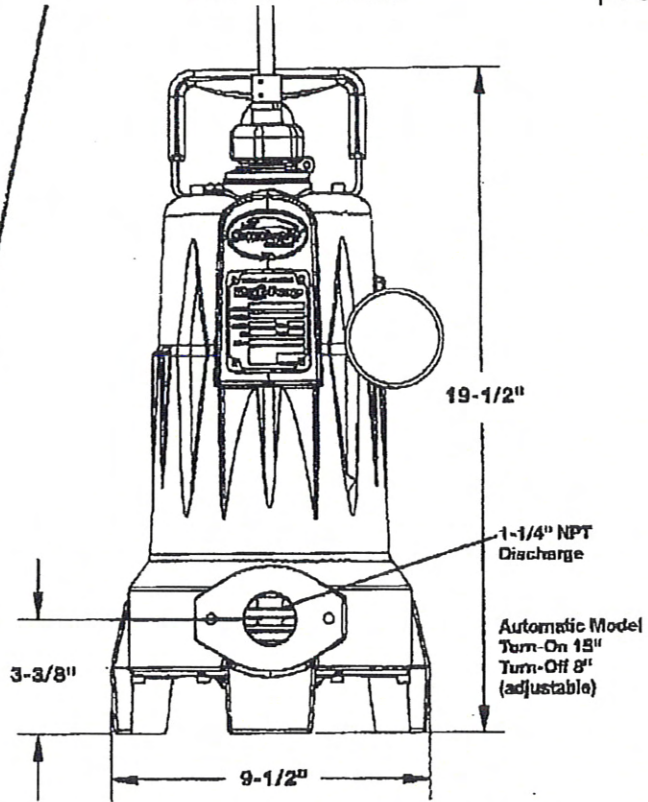
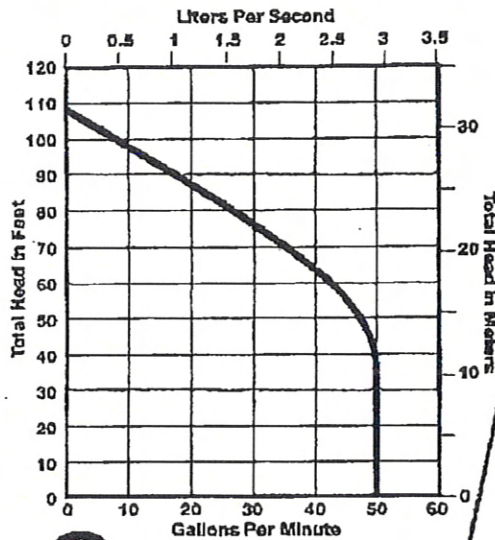

Model	HP	Volts	Phase	HZ	Amps	Locked Rotor Amps	Speed (RPM)	Discharge	Switch	Weight
LSG202A	2	208-230	1	60	15	53	3450	1-1/4"	Yes	86
LSG202M	2	208-230	1	60	15	53	3450	1-1/4"	No	84
LSG203M	2	208-230	3	60	10.8	62	3450	1-1/4"	No	84
LSG204M	2	440-480	3	60	5.3	31	3450	1-1/4"	No	84

Maximum fluid temperature 140° F



- Cast Iron construction
- Integrated ball check valve
- Single 1-1/4" guide rail pipe design
- Auto alignment feature (GR20 works only with LSG-Series pumps)
- Upper rail support bracket (GR20 option sold separately)

## GR20 Guide Rail Base with integrated ball check valve (sold separately)

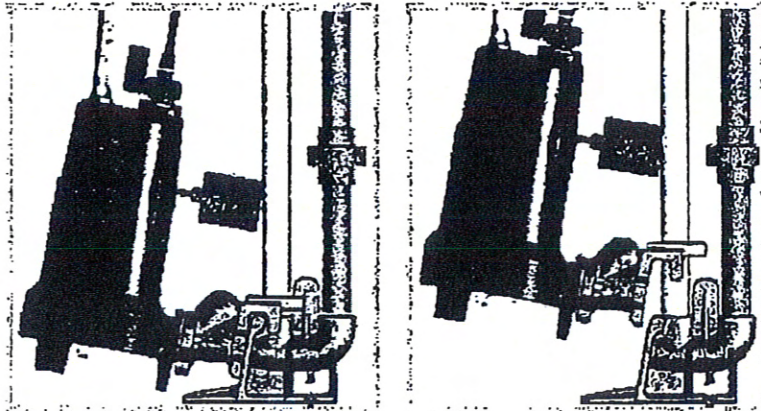

WWW.  
**libertypumps**  
.COM



Liberty Pumps • 7000 Apple Tree Avenue • Bergen, New York 14416  
Phone 800-543-2550 Fax (585) 494-1839

Specifications are subject to change without notice. Copyright © Liberty Pumps, Inc. 2004 All rights reserved. 1L1T3200 R09/06

# Liberty Pumps™

## LSG200-Series



**1-1/4" Discharge**  
**2 hp**

**Models:**

**LSG202A**  
208-230V, 1 phase, Automatic

**LSG202M**  
208-230V, 1 phase, Manual

**LSG203M**  
208-230V, 3 phase, Manual

**LSG204M**  
440-480V, 3 phase, Manual

**Features:**

- New V-Slice™ cutter technology
- One-piece uni-body casting
  - Stainless steel impeller
- Quick-disconnect power cord
  - Panel-less design (single phase models)
- 300 Series SS Rotor Shaft



innovate. evolve.



**FREE SHIP TO STORE<sup>†</sup> OR HOME<sup>\*</sup>. NOW AVAILABLE ON OVER 400,000 ITEMS.**

Your Store: Riverdale #4401 [\(Change\)](#)

**Generac 14,000-Watt Automatic Standby Generator with 200-Amp SE Rated Transfer Switch**



Model # 6241 Internet # 204006871

**\$3,086.10 / each**  
~~WAS \$3,429.00~~

Online Special Valid : 08/08/2013 - 08/22/2013

**10% off Generac Automatic Home Standby Generators**

This item cannot be shipped to the following state(s):  
 AK, GU, HI, PR, VI

**Free Shipping**

**Buy Online, Ship to Store**

**PRODUCT OVERVIEW**

Choose the #1 Selling Home Standby Generator Brand. Generac's 14kW Guardian Series provides the automatic backup power you need to protect your home and family during a power outage. Connected to your existing LP or natural gas fuel supply, it kicks in within seconds of determining power loss—automatically—and runs for as long as necessary until utility power returns. Control your power. Control your life.

- Want to learn about Standby generators and find the right one for you? Click here for our generator selector tool
- SYSTEM INCLUDES: 14 kW generator, 200 Amp transfer switch, Evolution™ controller, and composite mounting pad. Mobile Link™ and 26R battery purchased separately.
- 24/7 GENERAC CUSTOMER CARE support 365 days a year. Power outages do not always occur during normal working hours – that is why we are standing by.
- GENERAC'S OHVI® ENGINE is purpose-built to run dependably for extended periods, delivering power when you need it most.
- GENERAC'S EVOLUTION CONTROLLER features a dual-line, multilingual LCD display allowing for easy monitoring and management of generator functions, built-in hour meter, and external "at-a-glance" indicator lights.
- CERTIFIED FOR 18" INSTALLATION TO THE HOME (3rd Party-certified to NFPA standards provided it is located away from doors, windows and fresh air intakes, and unless otherwise directed by local codes.)
- EASY INSTALLATION with an intelligent pre-wired transfer switch, re-engineered connection points, and composite mounting pad that eliminates the need for a poured concrete base (unless specified by local codes.) Get it installed 800-557-5221
- TOOL-LESS FUEL CONVERSION allows for easy switching between natural gas and LP fuels in the field.
- RATED FOR OPERATION IN AREAS WITH LOW NATURAL GAS PRESSURE, significantly lower than published numbers for competitive standby systems (Generac is the only manufacturer to certify operation on only 3.5" of water column.)
- STURDY GALVANNEAL STEEL ENCLOSURE WITH RHINOCOAT™ FINISH for superior weather protection to withstand 150 mph winds .
- DPM™ TECHNOLOGY intelligently manages household loads for a more affordable standby solution.

**Info & Guides**

**Specification**

**Use and Care Manual**

**Warranty**

You will need Adobe® Acrobat® Reader to view PDF documents. [Download](#) a free copy from the Adobe Web site.

- TRUE POWER™ TECHNOLOGY provides clean, smooth operation of sensitive electronics and appliances.
- MOBILE LINK™ COMPATIBLE - wireless remote monitoring system. Receive status updates using your computer, tablet, or smart phone - giving you peace of mind, even when you're away (purchased separately).
- THE GENERAC PROMISE - Engineered and built in the USA supported by a five year limited warranty and 24/7 customer care support 365 days a year.
- Click on the "More Info" tab to download the specifications pdf to view the refer a friend rebate for the \$50 savings
- MFG Model # : 6241
- MFG Part # : 6241

## SPECIFICATIONS

Assembled Depth (in.)	48 in	Assembled Height (in.)	25 in
Assembled Width (in.)	29 in	Certifications and Listings	1-UL Listed,CSA Listed
Color Family	Grays	Commercial / Residential	Residential
Continuous Wattage	14000	ENERGY STAR Certified	No
Engine Displacement (cc)	992	Engine manufacturer	OHVI
Height	25 in	Hour Meter	Yes
Low oil shutdown	Yes	Manufacturer Warranty	5 Year Limited
Operational volume (dB)	66	Product Height (in.)	25
Product Length (in.)	48	Product Weight (lb.)	435
Product Width (in.)	29	Remote Monitoring	Sold Separately
Response time (sec.)	30	Returnable	Non-Returnable
Width	29 in		

## SHIPPING OPTIONS

Most orders process within 3 business days.

Please allow an additional 2-6 business days for **Curbside Truck Delivery** in the Continental U.S. Deliveries are made to receiving area/dock for Businesses or curbside for Residential orders. Delivery appointments are required.

*If product is eligible for shipping to AK, HI and US Territories, additional transit time and remote surcharges may apply.*

**This item is also available for pick up in your local store (FREE) within 4-7 business days, plus order processing time.**

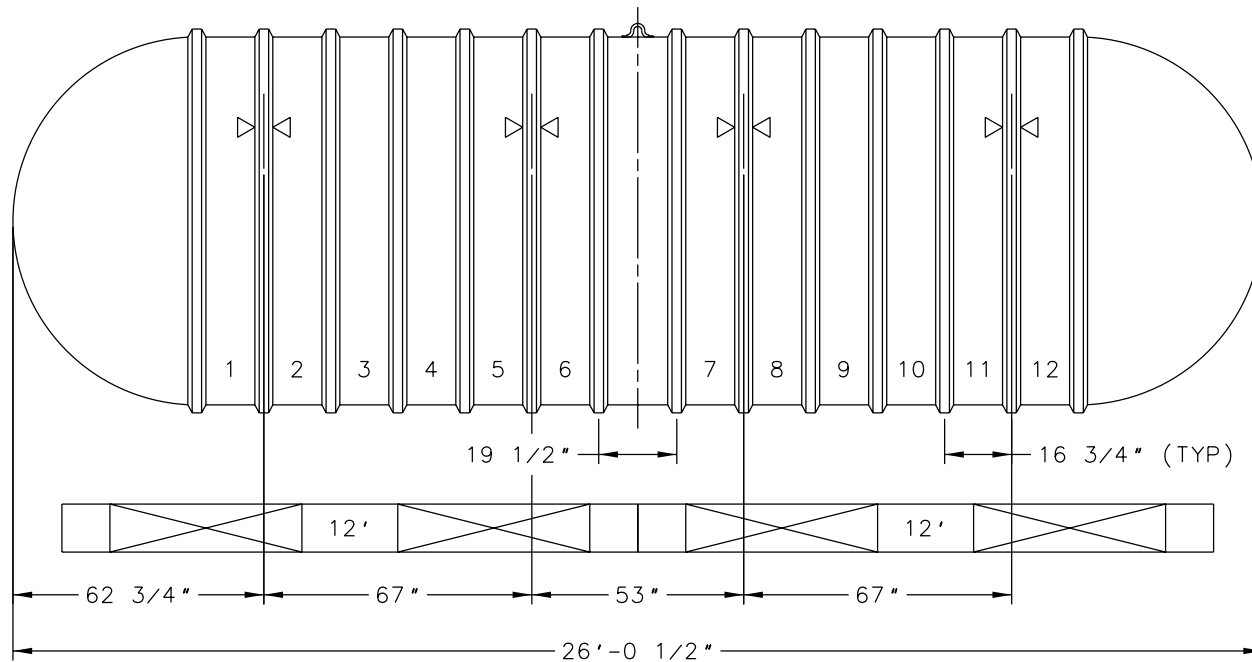

Optional prefabricated engineered concrete deadmen shown

<b>XERXES<sup>®</sup></b> a ZCL company	
TITLE 8' DIA. SINGLE-WALL CAP. 8,000 GALLONS	
DATE 1-12	DR. NO. S10-875.03

**XERXES<sup>®</sup>**

**CORPORATION**

a subsidiary of ZCL Composites Inc.

# Fiberglass Underground Wastewater Tanks

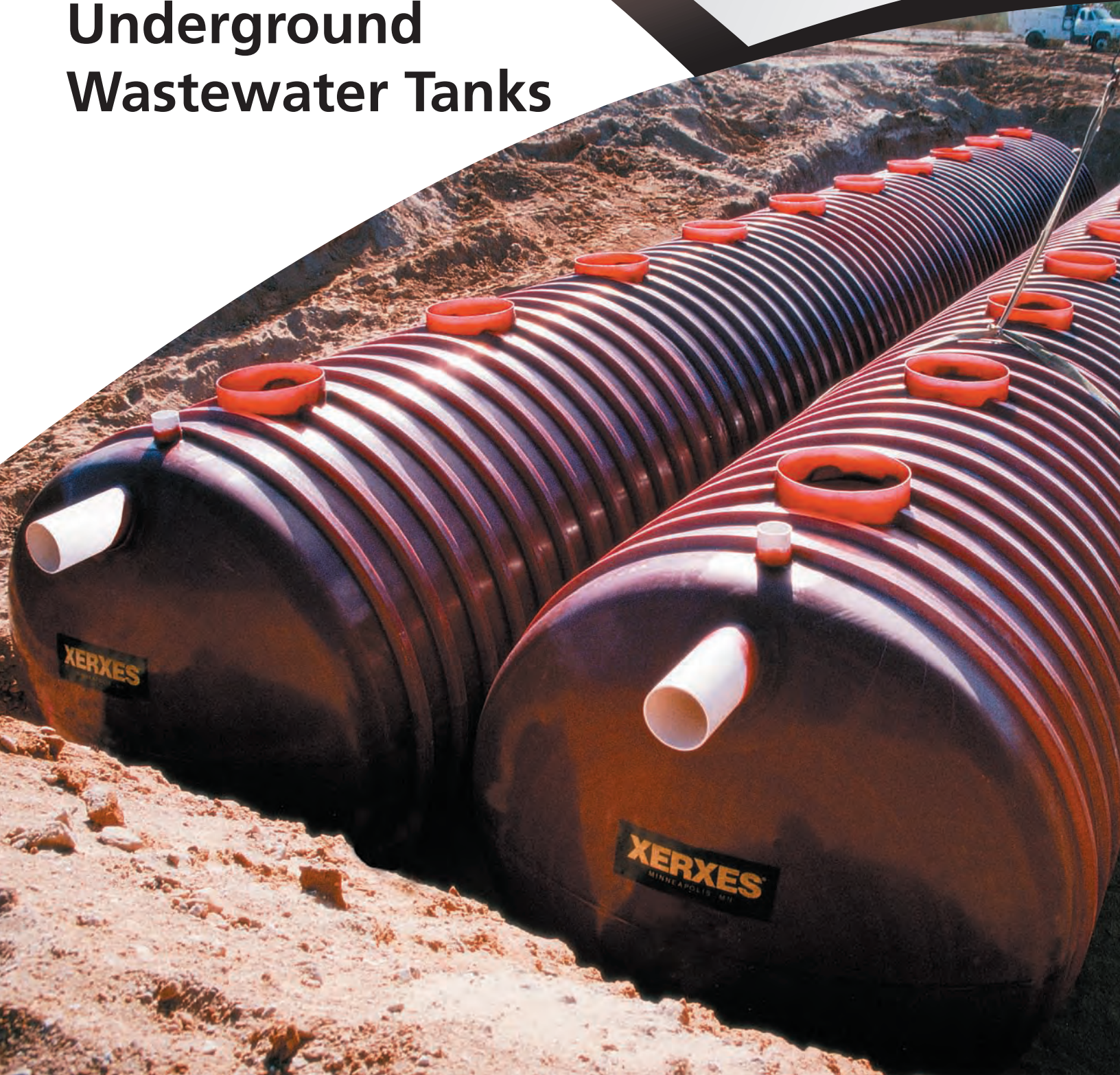

# Xerxes Fiberglass Wastewater Tanks

## Fiberglass Tanks for Long-Term Storage of Wastewater

As communities, businesses and industries become increasingly accountable to meet environmental requirements for liquids that require safe, design-proven storage, Xerxes is in the forefront with innovative answers. When considering the options in customized systems to process and store wastewater, facility designers and owners look for a long-term, structurally strong, watertight and cost-effective option. That is exactly what the Xerxes fiberglass tank is.

For decades, Xerxes has been well-known as a major tank supplier to the petroleum industry, with more than 150,000 tanks installed. Many of the world's largest oil companies rely on Xerxes to supply environmentally safe underground tanks for storage of gasoline at their retail service stations. Throughout the neighbor-

hoods and communities of America, Xerxes underground tanks are in place, simultaneously storing products and protecting the environment.

Today Xerxes is taking its place in those same neighborhoods and communities as a major supplier of storage tanks for wastewater applications — including septic, recirculation, dosing and holding tanks — as well as other liquids, such as leachate, chemicals, potable water, fire-protection water, irrigation water, gray water, rain water, stormwater and emergency-supply water. Each time a Xerxes fiberglass underground tank is delivered to a customer, the same performance standard has been met — a vessel for safe underground storage of liquid and careful protection of the environment.

## Tanks Designed & Manufactured by a Long-Time Industry Leader

Xerxes is a leader in the design and manufacture of high-quality, cost-effective products that help protect the fragile relationship between humans and their environment. Each Xerxes wastewater tank represents decades of innovation and proven experience developing and fabricating fiberglass storage tanks for underground storage of liquids.

At Xerxes, excellence in service is as highly valued as excellence in product design and manufacturing. Xerxes' four strategically located manufacturing facilities in the United States provide customers with prompt, economical delivery and quality service. That gives Xerxes tanks one more advantage — they are readily available to customers throughout the country.



# Watertight Tanks Featuring the Many Benefits of Fiberglass

A fiberglass wastewater tank, by virtue of its materials and design, is inherently the superior choice for safe, long-term storage and treatment of wastewater for a wide range of applications. The best storage system for wastewater is structurally strong, corrosion-resistant, watertight, easily installed and cost-effective. All these elements come together in the design and manufacture of a Xerxes fiberglass wastewater tank.

Xerxes uses only high-quality resin and glass in the manufacture of its fiberglass tanks. For added structural strength, Xerxes tanks are designed with integral ribs. Because the integral ribs and tank are made of the same materials and are manufactured simultaneously, the Xerxes tank is a very robust tank. It is designed to accommodate heavy traffic loads and high water-table conditions when properly installed. Fiberglass tanks available from smaller fabricators may also utilize ribs, but they may not be designed for traffic environments and do not have the same robust design features of a Xerxes tank. While concrete tanks are widely viewed as structurally strong, many are not designed for the heavy loading conditions that vehicle traffic and groundwater can present.

Since water by nature can create a corrosive environment, rust can be a major weakness in some underground wastewater storage systems. The materials used to construct Xerxes fiberglass tanks are inherently rustproof and corrosion-resistant. Concrete tanks, whether precast or poured-in-place, are susceptible to rust if the steel reinforcement is exposed through cracks in the concrete. Exposure to hydrogen sulfide gases, present in wastewater tanks, can also cause corrosion damage to a concrete tank and steel reinforcement, thereby limiting the tank's useful life. Since wastewater tanks can be exposed to highly corrosive conditions, selecting a Xerxes wastewater tank gives system owners and designers the assurance that rust or corrosion will not cause a leak or structural failure.

Aside from being rustproof and corrosion-resistant, a Xerxes tank is also designed to be watertight. Easily equipped for on-site pressure testing before or after installation, Xerxes wastewater tanks give owners the confidence that the tank is watertight from the day it is installed. This feature is of growing importance with today's stringent regulations, many requiring watertight systems. For more than 28 years Xerxes has been manufacturing thousands of underground tanks for use in the petroleum industry, where a zero leak rate is the accepted industry standard. These fuel tanks must be leak-free, not only upon installation, but for decades, verified by periodic, precision-testing practices that are routine for gasoline tanks.

Leaking concrete tanks are one of the reasons that Xerxes tanks have become such a popular choice for wastewater applications. Concrete, by its nature, is vulnerable to cracking. In most cases, precast concrete tanks rely on sealants or adhesives to seal the seams designed into the tank. When the ground around the tank shifts or settles, or when the tank is improperly installed, these seams are sus-



ceptible to leaking, causing either groundwater contamination or groundwater infiltrating into the tank, requiring the system to processes groundwater along with septage. A structurally strong, watertight fiberglass tank eliminates both of these problems.

Quality manufacturing is key to producing a strong, watertight tank. When it comes to the environment, Xerxes knows that too much is at stake to manufacture anything less than a superior underground storage tank. Xerxes maintains high standards of quality in the manufacture of each tank. The quality control steps are applied in a tightly controlled manufacturing environment. On the other hand, the same level of quality control may not be maintained in situations where tanks are assembled, in part or in whole, in the field and where weather conditions may not allow careful quality control procedures.

## Features of Xerxes Wastewater Tanks

- Constructed of rustproof, long-lasting fiberglass
- Manufactured to meet customers' functional requirements
- Designed with integral ribs for added strength
- Designed for H-20 load conditions
- Easy to ship and install
- Can be purchased with accessories that allow for both pre-installation or post-installation pressure testing
- Manufactured to applicable requirements of Underwriters Laboratories (UL) 1316 and ANSI/AWWA D120
- Able to be reinstalled after recertification by Xerxes
- Available in single-wall, double-wall and triple-wall models
- Available in sizes from 600 gallons to sizes in excess of 60,000 gallons

# The Design of Xerxes Wastewater Tanks Offers Many Advantages



Many advantages of a Xerxes wastewater tank come from the geometry of the tank itself. The Xerxes tank has a cylindrical shape and is domed at both ends, which offers major benefits in terms of both operation and maintenance. The shape of a Xerxes tank maximizes the natural flow of liquids through a vessel, allowing for the smooth flow of liquids through the tank and maximum use of the tank's interior.

A domed, cylindrical tank minimizes pockets or “dead” spots in which scum or sludge can accumulate. The smooth, rounded surfaces of the tank's interior provide a significant advantage when pumping out scum and sludge. Tanks designed with squared corners and sharp angles can have pockets and “dead” spots, creating two major disadvantages — diminished volume and spaces in which scum and sludge settle.

When a Xerxes wastewater tank is delivered to an installation site, all it needs to be ready for operation is connection of the piping and installation of the risers, which allow for easy access to the tank for maintenance and cleaning from above grade. Septic systems manufactured of other materials may be delivered in multiple pieces and require field assembly. That not only makes installation more difficult and time-consuming, it also increases the possibility of leakage once the system is in operation. The installation and proper curing of cast-in-place tanks can be very time-consuming, taking days or weeks, as opposed to the one-day installation typical for a Xerxes fiberglass tank.

Xerxes tanks fit a variety of wastewater applications. They can be used as septic tanks, recirculation tanks, dosing tanks, pump tanks, holding tanks and tanks using prepackaged treatment systems.

(Some typical applications are shown in these pages.) Xerxes tanks can be manufactured in sizes from 600 gallons to in excess of 60,000 gallons, with multiple compartments, and in single-wall, double-wall and triple-wall models. Whatever the application and whatever the size, each Xerxes fiberglass wastewater tank offers the same benefits: It is watertight, rustproof, corrosion-resistant and lightweight. A Xerxes tank is easy to install, easy to operate and easy to maintain.

All in all, from delivery to operation, Xerxes offers customers a superior option for all their wastewater tank needs.

## Typical Wastewater Applications

- Housing developments
- Municipalities
- Public parks
- Rural developments
- Sanitary stations
- Rest areas and truck stops
- Private RV parks
- Resorts
- Schools and recreation centers
- Business parks

## Dual-Compartment Septic Tank Applications

When an application calls for more than one compartment in a primary treatment system, Xerxes offers a dual-compartment fiberglass tank, which has two compartments with a baffle between them to control the waste stream. Xerxes also offers wastewater tanks with more than two compartments.

When an application requires more than one compartment, other systems may use a number of separate tanks, which increases the possibility of failed connections.

This is an example of a definite advantage that customers have with Xerxes dual-compartment septic tanks. Compartment sizes can be configured in a variety of arrangements to meet design

requirements. Recent Xerxes installations of dual-compartment septic tanks are residential septic systems in the desert, and septic systems in small business parks and schools.

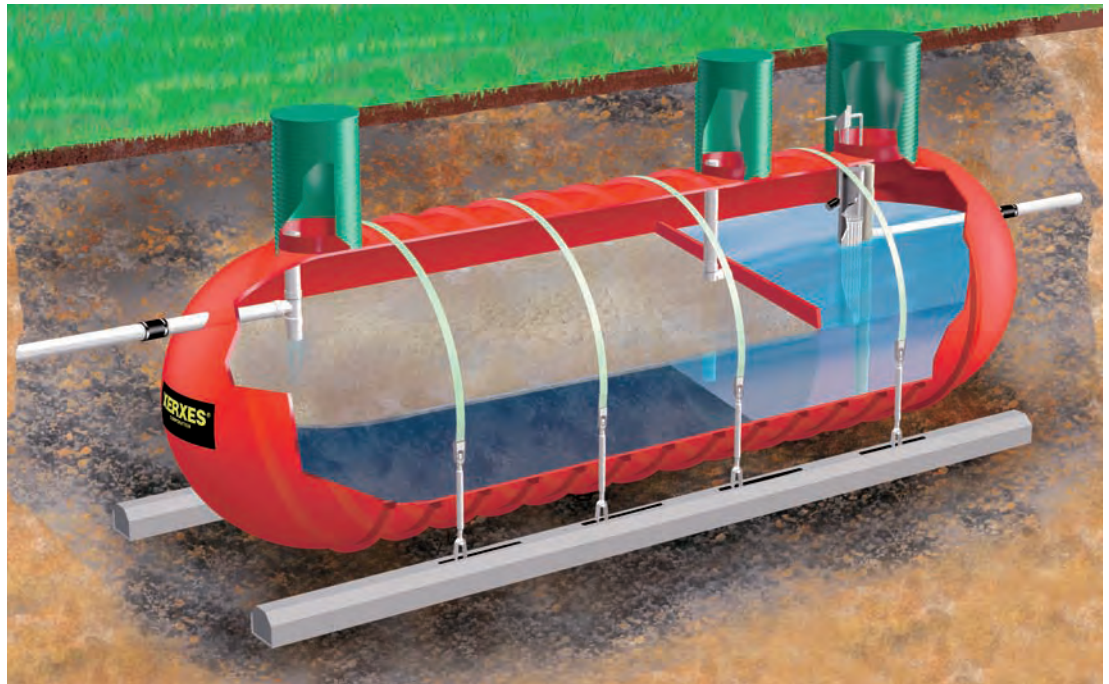

## Large Commercial Septic Tank Applications

When a customer needs a large commercial septic system, a Xerxes tank can serve as the sole tank in a septic system or as the second tank in a two-tank septic system. This Xerxes tank has a major advantage over build-in-place or multiple-tank systems, which typically require several smaller tanks to create a large system. Xerxes access-opening designs can also accommodate multiple pump chambers that are often necessary in large commercial-size tanks.

The Xerxes large commercial septic tank is a good fit for hotels and resorts where open green space is limited. Since Xerxes tanks are designed for H-20 load conditions, they can be installed under parking space. Recent installations of this type of Xerxes tank include a 150,000-gal-

lon/day treatment system for a resort community in the mountains and a 40,000-gallon/day treatment system for a conference center in the Midwest.

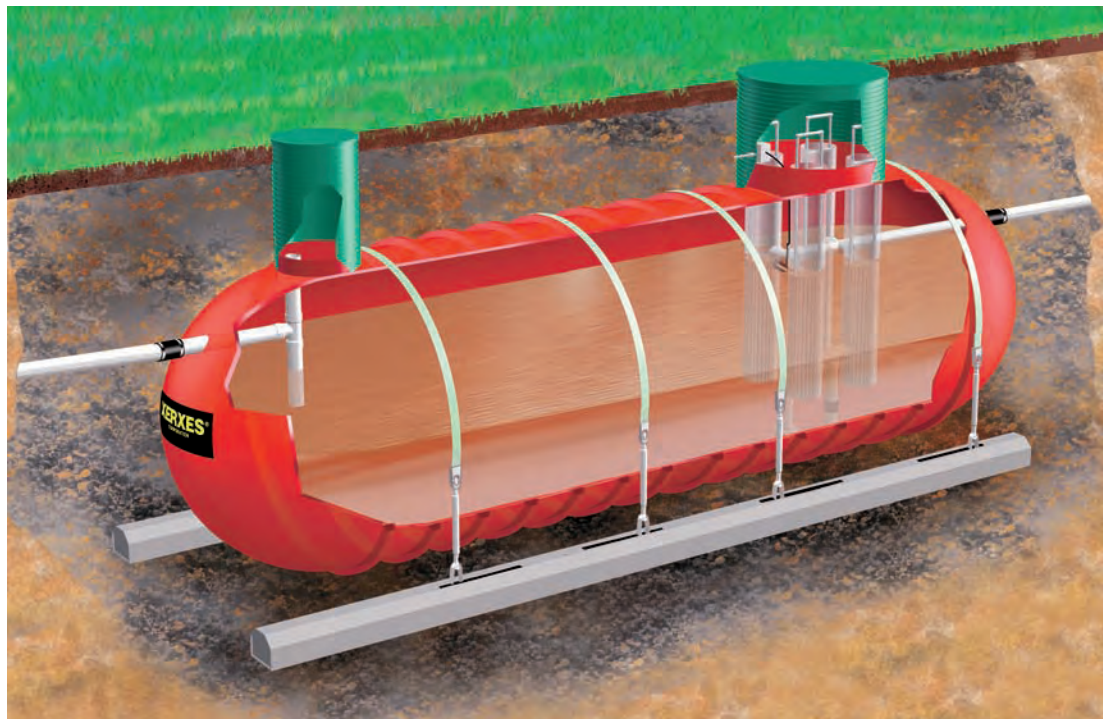



## Recirculation Tank Applications

One way of treating the waste stream is by recirculating the effluent through a filter (gravel, sand or peat, for instance). The common denominator in such secondary treatment systems is a recirculation tank. A Xerxes wastewater tank can be used in any system that requires recirculation of the waste stream.

Whether a wastewater customer is installing a new system or is retrofitting an existing system, a Xerxes recirculation tank, in which all waste liquids can be stored in one tank, is a superior option. Installing a Xerxes recirculation tank can eliminate the need to install a whole new septic system.

Recirculation tanks can be designed and manufactured to fit specific requirements for splitter valves and pumping equipment. Whether the system has a hanging pump chamber or a submerged pump mounted on a pump platform, Xerxes can provide a recirculation tank and accessories to fit a customer's specific requirements. If an application requires use of the entire tank capacity,

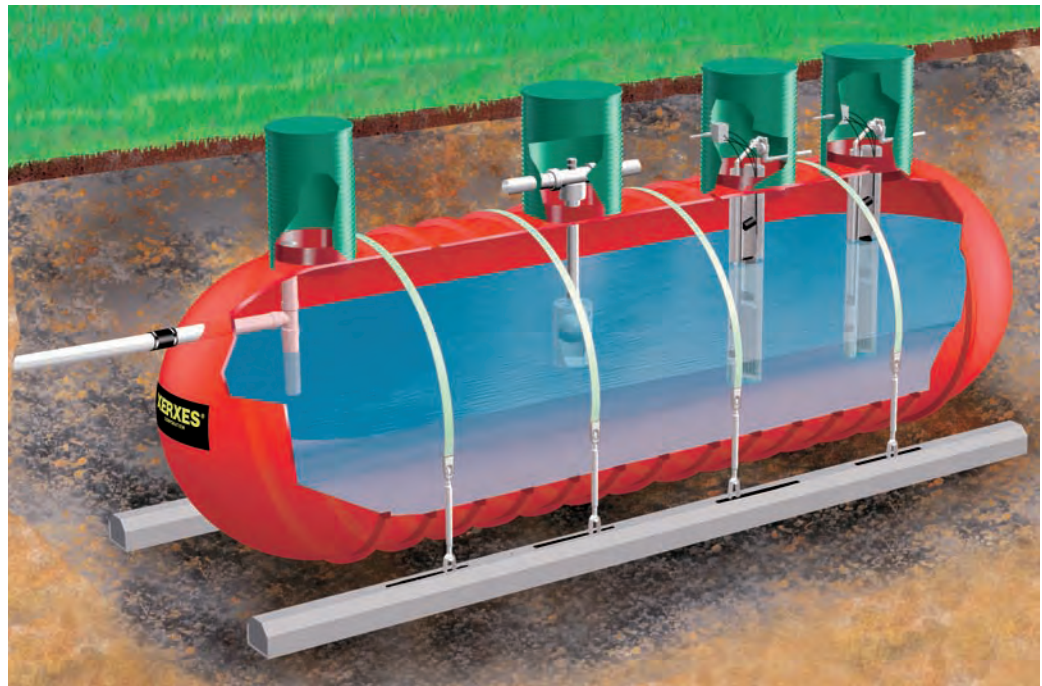

Xerxes also manufactures bottom sumps to meet this requirement. A typical example of a Xerxes recirculation tank application is a recently installed 10-foot-diameter, 30,000-gallon recirculation tank at a trailer park that previously had a concrete septic system that needed upgrading because of new regulations pertaining to existing secondary treatment systems.

## Dosing Tank Applications

Certain wastewater systems require a dosing tank. A Xerxes dosing tank is designed to receive the wastewater from a septic tank at two points in the process — after primary treatment and/or after secondary treatment — and then dispense of the effluent for final dispersal and/or disinfection.

A Xerxes fiberglass dosing tank allows for the storage of surge capacity in the system and periodic dispersal of doses of effluent into the drain field in one of two ways — either electrically with a pump or mechanically with a siphon. Each Xerxes tank is manufactured with the same structural integrity designed to handle the pressures of continuous filling and emptying of the tank at specified burial depths. A watertight, corrosion-resistant Xerxes

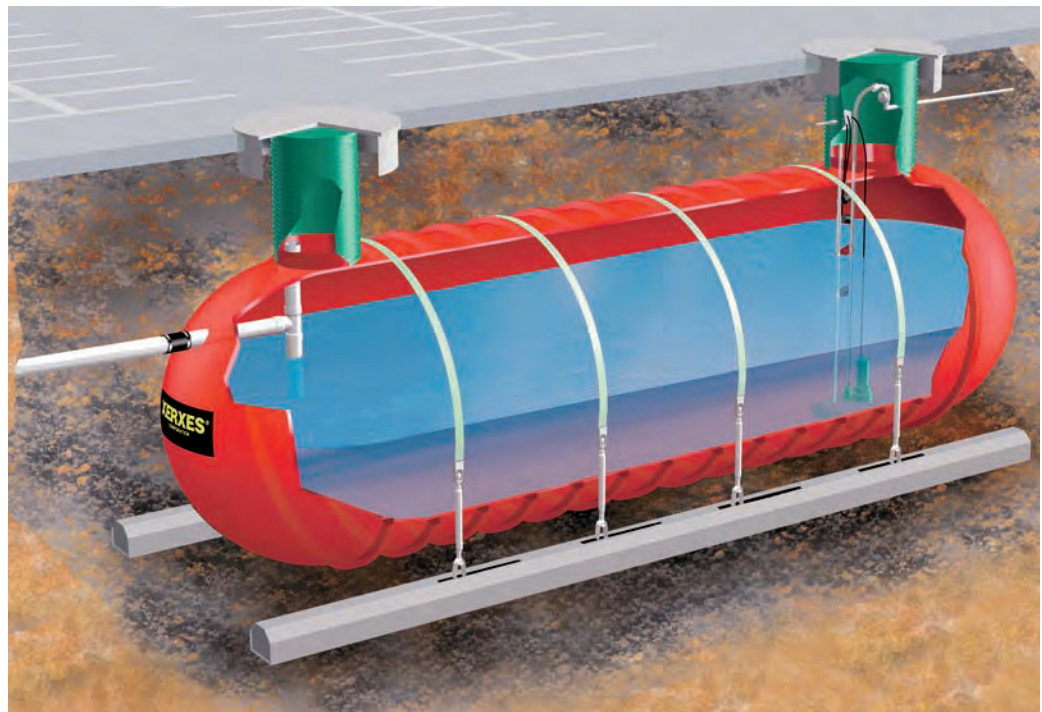

fiberglass tank is an excellent choice as a dosing tank in a wastewater system.

## Prepackaged Treatment System Applications

Many wastewater projects today are designed with an engineered prepackaged treatment system. These systems have a variety of designs, but all require a watertight, structurally strong, corrosion-resistant storage vessel. Xerxes offers all the options in tank design needed to accommodate most treatment systems. Whether the engineered system is a sequenced batch reactor (SBR), aerobic treatment unit (ATU), membrane bio-reactor (MBR) or other technology, Xerxes offers a range of advantages and flexible design options. One of these advantages is providing the customer with a product assembled in the plant and shipped to the project site as a complete system.

Xerxes installation of treatment components in the plant reduces or eliminates the requirement for tank entry in the field, thereby saving considerable installation time and expense. A confined space entry can be a costly step for the installer of the system. Also, because Xerxes assembles these components in a factory-controlled environment, the customer can receive a higher-quality finished product than with the many variables created by field assembly and installation. Additionally, the use of Xerxes tanks for collection and disposal along with Xerxes tanks for treatment provides the designer and/or owner with an entire system that is watertight and corrosion-resistant. In recent years, Xerxes has

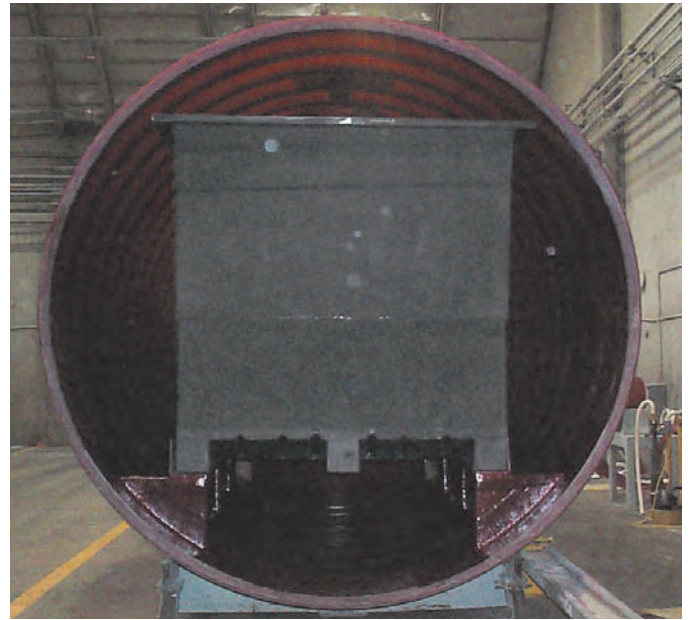

worked closely with many system suppliers to provide unique tank solutions for engineered prepackaged systems going to national park sites, housing developments, manufacturing facilities and schools.

## Other Wastewater Tank Applications



Lightweight, watertight and corrosion-resistant fiberglass tanks are ideally suited to a variety of wastewater projects, whether they are in a rural community, a remote location or the middle of a city. Each Xerxes wastewater tank is designed and manufactured to meet a customer's specific requirements. Today, many Xerxes tanks are finding their way into neighborhoods as septic tanks for single-family homes. (See photo above.)

Additional examples of recent Xerxes wastewater tank installations are: 1) a wastewater holding system for an amphitheater in Washington state; 2) a recirculating, sand-filter wastewater treatment system for a Minnesota housing development; 3) surge tanks, settling tanks and lift station/pump tanks for a city sewer system in Missouri; and 4) 62,000-gallon tanks for a wastewater treatment system for a desert housing development in Arizona.

# Optional Tank Accessories to Fit a Variety of Wastewater Applications

One of the ways Xerxes continues to meet the changing needs of the marketplace is to meet the functional requirements of system designers and owners. When it comes to the wastewater market, Xerxes has developed a line of accessories to complement the full

range of its wastewater tanks. Shown here are just a few of these accessories, including access openings, piping connections, baffles/partition walls, sumps, risers and deadmen.

## Access Openings

Xerxes offers a variety of fiberglass access openings for wastewater tanks. The access openings serve a variety of purposes, including as inspection openings and as openings for effluent filters (vaults). They are available in a range of sizes, from 24 inches to 48 inches in diameter and can include internal flanges to support pump vaults.



## Internal Baffles/Partition Walls

Xerxes' internal baffles and partition walls can improve treatment performance in wastewater tanks by maximizing the retention time of waste. These fiberglass accessories are designed and manufactured with the appropriate penetrations to fit the needs of specific applications.



## Piping Connections



Depending on the application, wastewater tanks require a variety of accessories for piping connections. Xerxes offers, in either PVC or FRP, inlet and outlet piping, and influent or effluent sanitary tees. These connections are manufactured to the size required for each application.

## Other wastewater tank accessories

To fit a variety of wastewater applications, Xerxes provides a wide range of accessories. These include access risers (photo to right), large-diameter bottom sumps (photo below), reinforced-concrete deadmen, fiberglass hold-down straps and fiberglass or aluminum ladders.



## Pump Platforms

Depending on the type of system design, a Xerxes wastewater tank may require a submerged pump. Among the accessories Xerxes offers are pump platforms designed to support submerged pumps located in the bottom of the tank.

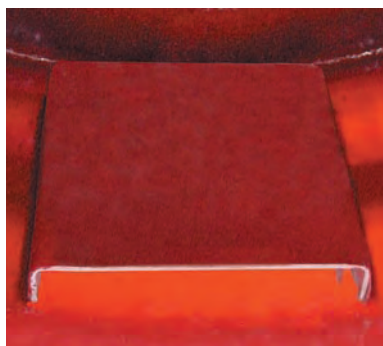

# Single-Wall Tank Data

Nominal Capacity (gallons)	Actual Capacity (gallons)	Nominal Tank Length	Nominal Shipping Weight (pounds)	Number of Hold-Down Straps Required
<b>4-Foot-Diameter Tanks</b>				
600	602	6'-11 7/8"	500	2
1,000	1,009	11'-3 7/8"	700	2
1,500	1,449	16'-0"	1,000	2
<b>6-Foot-Diameter Tanks</b>				
1,500	1,779	10'-7 1/4"	800	2
2,000	2,376	13'-5 3/4"	1,000	2
3,000	2,973	16'-4 1/4"	1,200	2
4,000	4,131	21'-11 1/8"	1,600	2
5,000	5,064	26'-5"	1,900	4
6,000	5,960	30'-8 3/4"	2,200	4
<b>8-Foot-Diameter Tanks</b>				
2,000	2,189	9'-1/2"	900	2
3,000	3,271	12'-3"	1,200	2
4,000	4,218	15'-1/2"	1,400	2
5,000	5,165	17'-8 1/2"	1,700	2
6,000	6,084	20'-6 1/2"	2,000	2
7,000	6,946	23'-1"	2,200	4
8,000	7,950	26'-1/2"	2,500	4
9,000	8,869	28'-9"	2,700	4
10,000	9,816	31'-6 1/2"	3,000	4
11,000	10,763	34'-4"	3,200	4
12,000	11,682	37'-1/2"	3,500	4
13,000	13,081	41'-2"	4,000	6
14,000	14,028	43'-11 1/2"	4,200	6
15,000	14,975	46'-9"	4,500	6
<b>10-Foot-Diameter Tanks</b>				
10,000	10,563	21'-5 1/4"	3,200	4
11,000	11,364	22'-9 3/4"	3,400	4
12,000	12,068	24'-1/4"	3,600	4
13,000	12,966	25'-6 3/4"	3,800	4
14,000	13,767	26'-11 1/4"	4,000	4
15,000	15,248	29'-5 3/4"	4,500	4
20,000	20,055	37'-8 3/4"	5,700	6
22,000	22,580	42'-3/4"	6,600	8
25,000	25,783	47'-6 3/4"	7,900	8
30,000	30,590	55'-9 3/4"	9,400	10
35,000	35,397	64'-3/4"	10,500	12
40,000	41,004	73'-8 1/4"	12,100	14
<b>12-Foot-Diameter Tanks</b>				
20,000	20,781	29'-4"	9,200	6
25,000	25,541	35'-7"	10,600	8
30,000	31,253	43'-1"	12,500	10
35,000	36,013	49'-4"	13,900	12
40,000	39,821	54'-4"	15,000	12
48,000	48,389	65'-7"	17,700	18
50,000	50,293	68'-1"	18,300	18

# Guide Specifications – Single-Wall FRP Tanks for Septic Use

## Short Form:

The contractor shall provide a single-wall fiberglass reinforced plastic (FRP) underground storage tank as shown on the drawings. Sizes and fittings shall be as shown. The tank shall be a fiberglass tank as manufactured by Xerxes Corporation.

Tank shall be tested and installed according to the Xerxes Installation Manual and Operating Guidelines in effect at time of installation.

## Long Form:

### Part I: General

#### 1.01 Quality Assurance

##### A. Acceptable Manufacturer: Xerxes Corporation

##### B. Governing Standards, as applicable:

1. Tank manufacturer shall be in the business of manufacturing tanks to Underwriters Laboratories, Inc. (UL) Standard 1316.
2. Tank manufacturer shall be in the business of manufacturing tanks conforming to the requirements of ANSI/AWWA D120 Thermosetting Fiberglass-Reinforced Plastic Tanks.

### Part II: Products

#### 2.01 Single-Wall Fiberglass Reinforced Plastic (FRP) Underground Storage Tanks:

##### A. Loading Conditions — Standard tank design shall meet the following criteria:

1. Internal Load — Tank shall be designed to withstand a 5-psig air-pressure test (3 psig for a 12'-diameter tank) with a 5:1 safety factor. When tank is designed for on-site testing, contractor shall individually test tank for leakage prior to installation. Maximum test pressure is 5 psig (3 psig for a 12'-diameter tank).
2. Surface Loads — Tank shall withstand surface H-20 axle loads when properly installed according to tank manufacturer's current Installation Manual and Operating Guidelines.
3. External Hydrostatic Pressure — Tank shall be capable of being buried in ground with 7' of overburden over the top of the tank, the hole fully flooded and a safety factor of 5:1 against general buckling.
4. Tank shall support accessory equipment — such as inlet and outlet piping, effluent filter chamber, ladders and baffles — when installed according to tank manufacturer's current Installation Manual and Operating Guidelines.

##### B. Product Storage:

1. Tank shall be capable of storing wastewater products limited to the collection and storage of human solid or liquid organic sewage.
2. Tank shall be vented to atmospheric pressure.
3. Tank shall be capable of storing products identified in the manufacturer's current standard limited warranty.

##### C. Materials:

1. Tank shall be manufactured with 100% resin and glass-fiber reinforcement. No sand fillers.

2. Resin used in tank and accessories shall be premium isophthalic polyester.

##### D. Tank Dimensions (Refer to Xerxes literature on gallonage.):

1. Tank shall have nominal capacity of \_\_\_\_\_ gallons.
2. Tank shall have nominal outside diameter of \_\_\_\_\_ feet.

#### 2.02 Accessories

##### A. Piping:

1. Schedule 40 PVC or FRP pipe shall be used for inlet and outlet piping.
2. When a PVC pipe is affixed to the tank, a fiberglass lay-up is used.
3. All piping shall be factory-sealed to enable field tightness testing with at least one pipe opening provided with a threaded fitting for connecting a pressure-test manifold.

##### B. Access Openings:

1. All access openings 24 inches in diameter or larger shall be manufactured of FRP.
2. Location(s) shall be as shown on tank drawings.
3. Optional riser extensions shall be FRP or PVC.
4. With tanks designed for on-site tightness testing, all access openings shall be factory-sealed to enable field tightness testing.

##### C. Optional Anchor Straps:

1. Straps shall be FRP anchor straps as supplied by tank manufacturer.
2. Number and location of straps shall be specified in current literature by tank manufacturer.

##### D. Optional Ladders:

1. Ladders shall be the standard ladder as supplied by tank manufacturer.

##### E. Optional Fittings:

1. All threaded fittings shall be constructed of carbon steel or FRP.
2. All standard threaded fittings shall be half-couplings and shall be 2", 4" or 6" in diameter. Reducers are to be used for smaller sizes where shown and provided by contractor.
3. All FRP and PVC nozzles shall be flat-faced and flanged, and shall conform to ANSI B16.5 150# bolting pattern.

##### F. Optional Internal Pump Platforms:

1. Pump platforms shall be FRP.
2. Contact tank manufacturer with pump details, such as dimensions and weight

### Part III: Testing and Installation

#### 3.01 Testing

**A. Testing**—Tank shall be tested according to the Xerxes Installation Manual and Operating Guidelines in effect at time of installation.

**B. Optional Testing**—Prior to installation, a tank-tightness test consisting of a 5 psig air pressure/soap test shall be performed (3 psig for 12-foot-diameter tanks) per the tank testing procedures outlined in the Xerxes

# Guide Specifications – Single-Wall FRP Tanks for Septic Use

Installation Manual and Operating Guidelines in effect at time of installation.

B. Tank shall be installed according to the Xerxes Installation Manual and Operating Guidelines in effect at time of installation.

## 3.02 Installation

A. Contractor shall be trained in proper installation procedures by the tank manufacturer, the state or other approved agency.

## Part IV: Warranty

### 4.01 Warranty

A. Warranty shall be manufacturer's standard limited warranty for underground septic tanks in effect at time of purchase.

---

## Limited Warranty Underground Septic Tanks

Xerxes Corporation ("Xerxes") warrants to ("Owner") that our underground septic tanks, and all Xerxes manufactured septic tank accessories, if installed, used and maintained in the United States in accordance with Xerxes' published specifications, installation instructions and operating guidelines, all applicable laws and regulations, and the limited septic applications defined herein, will be free from material defects in materials and workmanship for a period of one (1) year from date of original delivery by Xerxes. Septic applications for purposes of this warranty are limited to the collection and storage of solid or liquid organic sewage and wastewater at temperatures not to exceed 140° F.

If any tank is to be removed from an installation, moved to Owner's new location and is intended for active service at the new location, the tank must be recertified by Xerxes in order to maintain the warranty as originally extended. The foregoing warranty does not extend to tanks or accessories (collectively "Goods") damaged due to acts of God, war, terrorism, or failure of Goods caused, in whole or in part, by misuse, improper installation, storage, servicing, maintenance, or operation in excess of their rated capacity, contrary to their recommended use, or contrary to the septic applications defined above, whether intentional or otherwise, or any other cause or damage of any kind not the fault of Xerxes. Xerxes only warrants repairs or alterations performed by Xerxes or its authorized contractors. Xerxes does not warrant any product, components or parts manufactured by others.

XERXES' OBLIGATIONS UNDER THIS LIMITED WARRANTY ARE NULL AND VOID IF A TANK HAS BEEN USED FOR PRODUCTS CONTAINING A "HAZARDOUS SUBSTANCE" AS DEFINED BY THE COMPREHENSIVE ENVIRONMENTAL RESPONSE, COMPENSATION AND LIABILITY ACT OF 1980 (CERCLA OR "SUPERFUND") WHICH DESIGNATES CERTAIN CHEMICALS AS "HAZARDOUS SUBSTANCES." SEE 42 UNITED STATES CODE, SECTION § 9601 (14).

Owner's sole and exclusive remedy for breach of warranty is limited at Xerxes' option to: (a) repair of the defective tank or accessory, (b) delivery of replacement tank or accessory to the point of original delivery, or (c) refund of the original purchase price. A claimant must give Xerxes the opportunity to observe and inspect the tank and/or accessory prior to removal from the ground or the claim will be forever barred. All claims must be made in writing within one (1) year after tank and/or accessory failure or be forever barred. THE FOREGOING LIMITED WARRANTY CONSTITUTES XERXES' EXCLUSIVE OBLIGATION AND XERXES MAKES NO OTHER WARRANTY OR REPRESENTATION, EXPRESS OR IMPLIED, WITH RESPECT TO THE TANK OR ANY SERVICE, ADVICE, OR CONSULTATION, IF ANY, FURNISHED TO OWNER BY XERXES OR ITS REPRESENTATIVES, WHETHER AS TO MERCHANTABILITY, FITNESS FOR A PARTICULAR PURPOSE, OR OTHERWISE. THE SELLER (XERXES) UNDERTAKES NO RESPONSIBILITY FOR THE QUALITY OF THE GOODS, EXCEPT AS OTHERWISE PROVIDED IN THIS CONTRACT. THE SELLER (XERXES) ASSUMES NO RESPONSIBILITY THAT THE GOODS WILL BE FIT FOR ANY PARTICULAR PURPOSE FOR WHICH YOU (OWNER) MAY BE BUYING THESE GOODS, EXCEPT AS OTHERWISE PROVIDED IN THE CONTRACT. THE REMEDIES SET FORTH IN THE ABOVE LIMITED WARRANTY ARE THE ONLY REMEDIES AVAILABLE TO ANY PERSON OR ENTITY FOR BREACH OF WARRANTY OR FOR BREACH OF ANY OTHER COVENANT, DUTY, OR OBLIGATION ON THE PART OF XERXES. XERXES SHALL HAVE NO LIABILITY OR OBLIGATION TO ANY PERSON OR ENTITY FOR BREACH OF ANY OTHER COVENANT, DUTY, OR OBLIGATION UNDER THIS LIMITED WARRANTY EXCEPT AS EXPRESSLY SET FORTH HEREIN. IT IS EXPRESSLY AGREED THAT THIS LIMITED WARRANTY DOES NOT FAIL OF ITS ESSENTIAL PURPOSE. XERXES SHALL HAVE NO LIABILITY FOR COSTS OF INSTALLATION OR REMOVAL OF GOODS, ENVIRONMENTAL CONTAMINATION, FIRES, EXPLOSIONS, OR ANY OTHER CONSEQUENCES ALLEGEDLY ATTRIBUTABLE TO A BREACH OF WARRANTY, OR INCIDENTAL, CONSEQUENTIAL, PUNITIVE OR OTHER DAMAGES OF ANY DESCRIPTION, WHETHER ANY SUCH CLAIM OR DAMAGES BE BASED UPON WARRANTY, CONTRACT, NEGLIGENCE, STRICT LIABILITY OR OTHER TORT, OR OTHERWISE. IN NO EVENT SHALL XERXES' TOTAL LIABILITY HEREUNDER EXCEED THE ORIGINAL PURCHASE PRICE OF THE GOODS WHICH GAVE RISE TO SUCH LIABILITY.

Consumer Notice: This Limited Warranty gives you (Owner) specific legal rights. You (Owner) may also have other rights which vary from state to state.

Effective: 1/1/07



### Xerxes Manufacturing Facilities

### ZCL Manufacturing Facilities

#### Anaheim, CA

Phone 714.630.0012

Fax 714.632.7133

#### Hagerstown, MD

Phone 301.223.6933

Fax 301.223.6836

#### Edmonton, AB

Phone 800.661.8265

Fax 780.466.6126

#### Drummondville, QC

Phone 800.661.8265

Fax 780.466.6126

#### Seguin, TX

Phone 830.372.0090

Fax 830.372.0321

#### Tipton, IA

Phone 563.886.6172

Fax 563.886.2042

#### Waverley, NS

Phone 800.661.8265

Fax 780.466.6126

# XERXES®

**CORPORATION**

a subsidiary of ZCL Composites Inc.

7901 Xerxes Avenue South  
 | Minneapolis | MN | 55431-1288  
 Ph: 952.887.1890 Fax: 952.887.1882



Hagerstown, MD

[www.xerxescorp.com](http://www.xerxescorp.com)