

# POWDER MOUNTAIN

## Hidden Valley Yurt

### Site Plans

WEBER COUNTY, UTAH  
SEPTEMBER, 2012

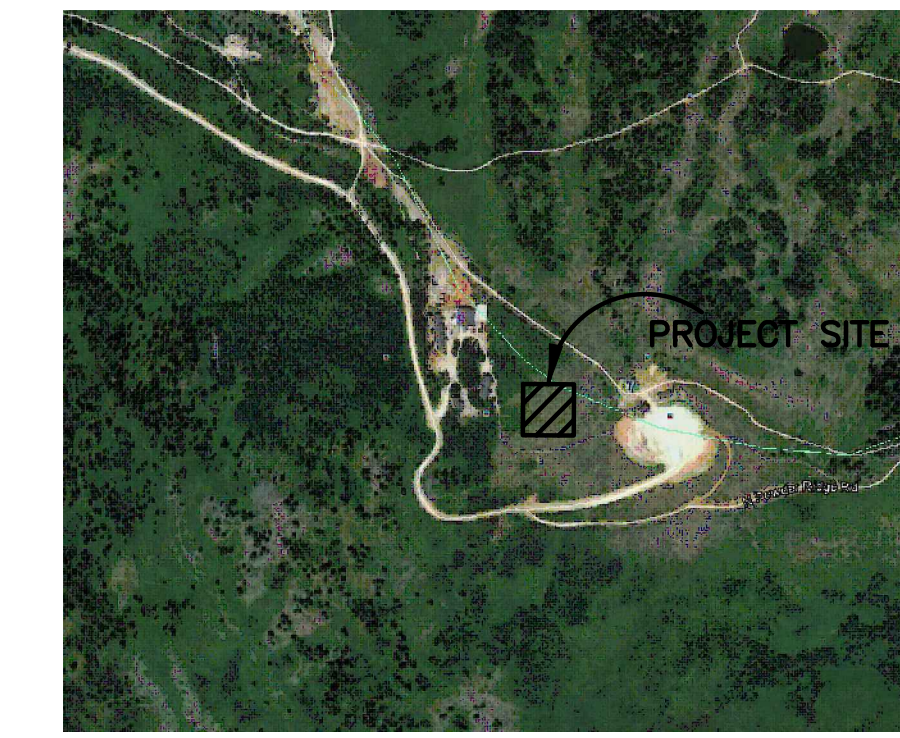
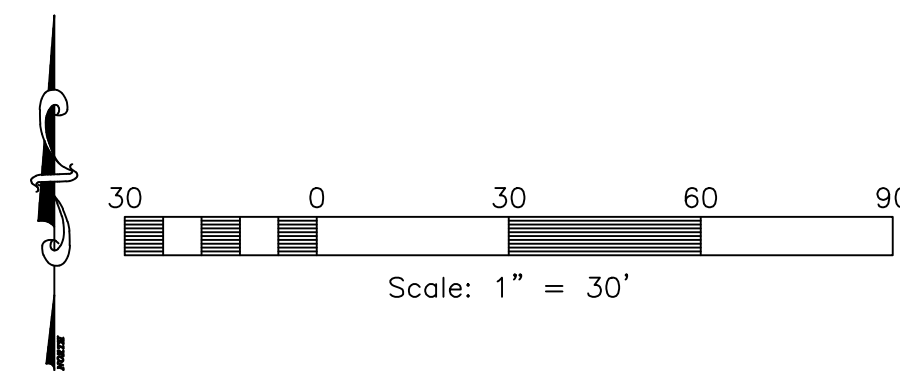
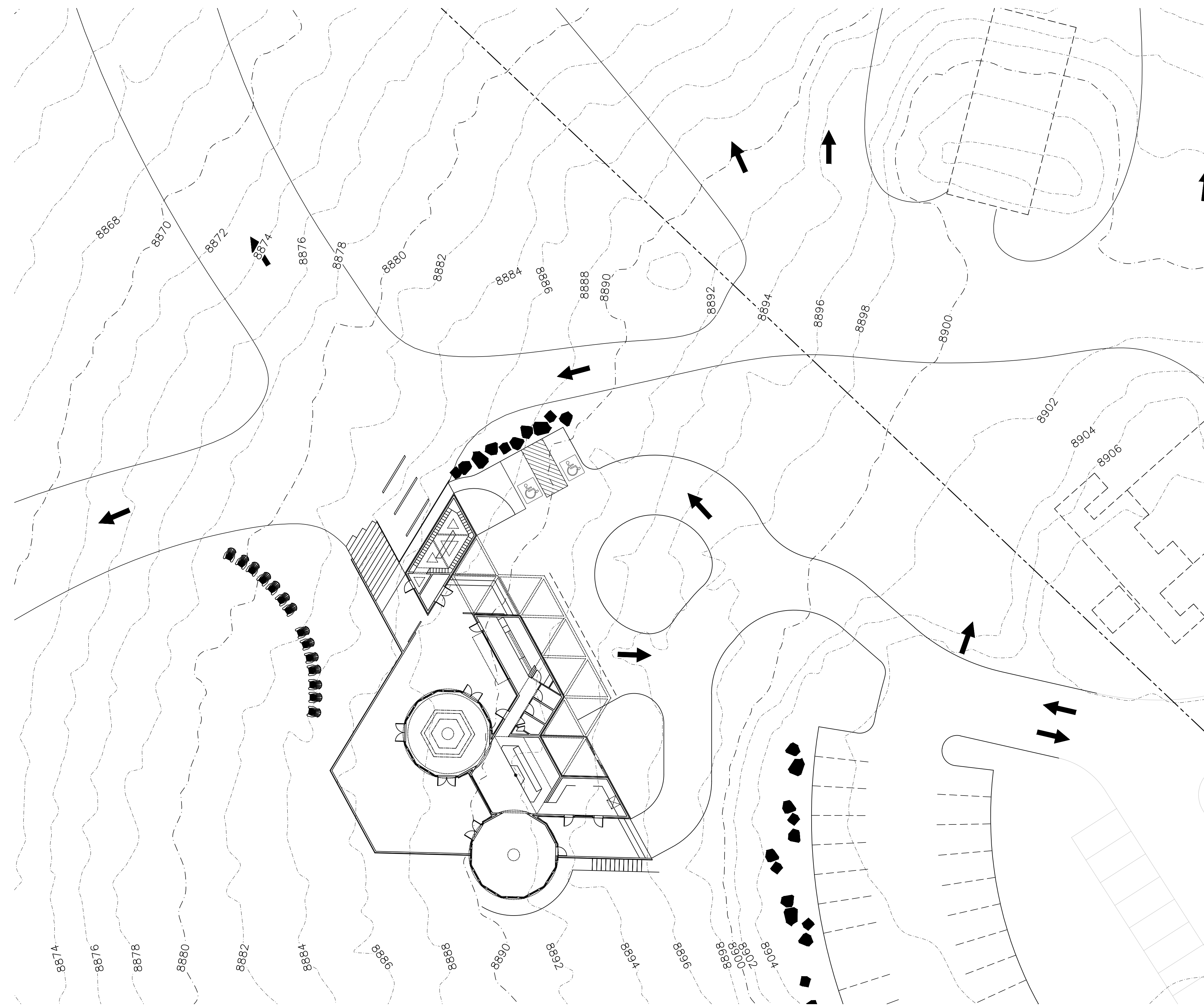

Vicinity Map  
NOT TO SCALE

#### General Notes

1. THE CONTRACTOR SHALL BE FULLY RESPONSIBLE FOR LOCATING AND PROTECTING FROM DAMAGE ALL EXISTING UTILITIES AND IMPROVEMENTS WHETHER OR NOT SHOWN ON THESE PLANS. THE FACILITIES AND IMPROVEMENTS ARE BELIEVED TO BE CORRECTLY SHOWN BUT THE CONTRACTOR IS REQUIRED TO SATISFY HIMSELF AS TO THE COMPLETENESS AND ACCURACY OF THE LOCATIONS. ANY CONTRACTOR PERFORMING WORK ON THIS PROJECT SHALL FAMILIARIZE THEMSELVES WITH THE SITE AND SHALL BE HELD SOLELY RESPONSIBLE FOR ANY DAMAGE TO EXISTING FACILITIES RESULTING DIRECTLY, OR INDIRECTLY, FROM THEIR OPERATIONS, WHETHER OR NOT SAID FACILITIES ARE SHOWN ON THESE PLANS.
2. ANY MODIFICATION TO THIS CONSTRUCTION PACKAGE OR TO THE CONSTRUCTION SCHEDULE SHALL BE APPROVED BY THE ARCHITECT. PRIOR TO SAID APPROVAL, ALL IMPROVEMENT DRAWINGS SHALL BE RESUBMITTED AND APPROVED BY THE ARCHITECT.
3. THE CONTRACTOR SHALL LOCATE, RETAIN AND PROTECT ALL EXISTING UTILITIES UNLESS OTHERWISE DIRECTED BY THE OWNER OR OWNER'S REPRESENTATIVE.
4. THE CONTRACTOR SHALL MAINTAIN 10 FOOT HORIZONTAL AND 18 INCH VERTICAL SEPARATION, CULINARY WATER LINES, SANITARY SEWER, AND STORM DRAIN LINES.
5. THE CONTRACTOR SHALL INSTALL ALL SANITARY SEWER MAINS, SERVICE LINES AND STORM DRAIN LINES PRIOR TO INSTALLING ANY WATER SYSTEM IMPROVEMENTS. ADJUST WATER MAIN DEPTH PER JURISDICTION AS REQUIRED TO AVOID SANITARY SEWER SERVICE LINES.
6. CONTRACTOR SHALL NOTIFY ARCHITECT OF ALL UTILITY CONFLICTS UPON DISCOVERY.
7. CONTRACTOR SHALL COORDINATE CONSTRUCTION AND INSTALLATION OF ELECTRICAL, TELEPHONE, NATURAL GAS AND CABLE TV SERVICES WITH THE RESPECTIVE UTILITY COMPANY. OWNER SHALL PAY ALL ASSOCIATED UTILITY COMPANY FEES.
8. CONTRACTOR SHALL BE RESPONSIBLE FOR PROPER SLOPE AND CONSTRUCTION OF CONNECTING SEWER PIPING.
9. CONTRACTOR SHALL BE RESPONSIBLE OF PROPER BACKFILLING, COMPACTING, AND PAVEMENT RESTORATION.
10. CONTRACTOR TO OBTAIN ALL NECESSARY PERMIT(S) AND COMPLY WITH ALL PERMITTING REQUIREMENTS.
11. ALL THRUST BLOCKS SHALL BE POURED IN PLACE AGAINST UNDISTURBED SOIL. ALL VALVES, FITTINGS, AND APPURTENANCES TO BE BLOCKED.
12. ALL EXPOSED NUTS AND BOLTS WILL BE COATED WITH A NON-OXIDE WASH AND WRAPPED IN 8-MIL POLYETHYLENE AS DIRECTED BY GEOTECHNICAL STUDY.
13. CONTRACTOR SHALL BE RESPONSIBLE FOR DUST CONTROL ACCORDING TO GOVERNING AGENTS STANDARDS. WET DOWN DRY MATERIALS AND RUBBISH TO PREVENT BLOWING.
14. CONTRACTOR SHALL BE RESPONSIBLE FOR ANY DAMAGE TO ADJACENT SURFACE IMPROVEMENTS DURING CONSTRUCTION.
15. CONTRACTOR SHALL BE RESPONSIBLE FOR CORRECTING ANY SETTLEMENT OF OR DAMAGE TO EXISTING UTILITIES FOR WARRANTY PERIOD.
16. ALL EXISTING ASPHALT SHALL BE SAW CUT IN NEAT STRAIGHT LINES BY THE CONTRACTOR PRIOR TO EXCAVATION.
17. CONTRACTOR TO INSTALL MAGNETIC LOCATING TAPE CONTINUOUSLY OVER ALL PVC PIPING.
18. THE CONTRACTOR IS RESPONSIBLE TO FURNISH ALL MATERIALS TO COMPLETE PROJECT.
19. TRAFFIC CONTROL IS TO CONFORM TO THE CURRENT CITY AND/OR STATE TRANSPORTATION ENGINEERS' MANUAL.
20. A UPDES GENERAL CONSTRUCTION STORM WATER PERMIT MUST BE OBTAINED BY THE GENERAL CONTRACTOR PRIOR TO COMMENCING CONSTRUCTION.
21. ALL WORK SHALL CONFORM TO THE CURRENT EDITION OF ALL LOCAL, D.O.T. & APPLICABLE STANDARD SPECIFICATIONS AND DRAWINGS.

#### Engineer's Notice To Contractors

THE EXISTENCE AND LOCATION OF ANY UNDERGROUND UTILITY PIPES OR STRUCTURES SHOWN ON THESE PLANS WERE OBTAINED FROM AVAILABLE INFORMATION PROVIDED BY OTHERS. THE LOCATIONS SHOWN ARE APPROXIMATE AND SHALL BE CONFIRMED IN THE FIELD BY THE CONTRACTOR, SO THAT ANY NECESSARY ADJUSTMENT CAN BE MADE IN ALIGNMENT AND/OR GRADE OF THE PROPOSED IMPROVEMENT. THE CONTRACTOR IS REQUIRED TO CONTACT THE UTILITY COMPANIES AND TAKE DUE PRECAUTIONARY MEASURE TO PROTECT ANY UTILITY LINES SHOWN, AND ANY OTHER LINES OBTAINED BY THE CONTRACTOR'S RESEARCH, AND OTHERS NOT OF RECORD OR NOT SHOWN ON THESE PLANS.

**Contact:**  
SUMMIT DEVELOPMENT - RYAN BRADLEY  
1325 N. 5900 W., Eden, UT 84310  
PH: (801) 664-6683

Blue Stakes Location Center  
**Call: Toll Free**  
**1-800-662-4111**  
Two Working Days Before You Dig

**Reeve & Associates, Inc.**  
920 CHAMBERS STREET, SUITE 14, OGDEN, UTAH 84403  
TEL: (801) 621-2100 FAX: (801) 621-2666 WWW.REEVE-ASSOC.COM  
LAND PLANNERS • CIVIL ENGINEERS • LAND SURVEYORS  
TRAFFIC ENGINEERS • STRUCTURAL ENGINEERS • LANDSCAPE ARCHITECTS

REVISIONS	DESCRIPTION
DATE	

**Powder Mountain Hidden Lake Yurt**  
WEBER COUNTY, UTAH  
**Cover Sheet**

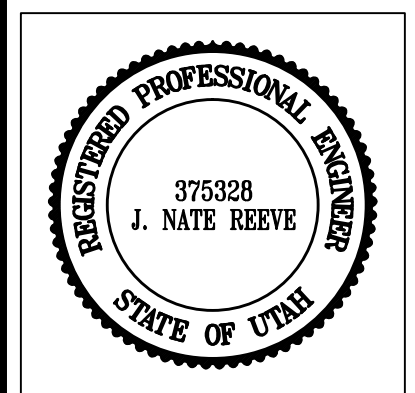

**Project Info.**

Engineer:	J. NATE REEVE, P.E.
Drafter:	R. HANSEN
Begin Date:	SEPTEMBER 17, 2012
Name:	POWDER MOUNTAIN HIDDEN LAKE YURT
Number:	6101-01

Sheet	<b>5</b>
<b>1</b>	Sheets

### Legend

- EX.SS — = EXISTING SANITARY SEWER LINE
- = EXISTING MANHOLE
- BLDG = BUILDING
- FFE = FINISH FLOOR ELEVATION
- FG = FINISHED GRADE
- SS = SANITARY SEWER
- TOC = TOP OF GRAVEL SURFACE

**Reeve & Associates, Inc.**  
 820 CHAMBERS STREET, SUITE #14, OGDEN, UTAH 84403  
 TEL: (801) 621-3100 FAX: (801) 621-2668 www.reeve-assoc.com  
 CIVIL ENGINEERS • STRUCTURAL ENGINEERS • LANDSCAPE ARCHITECTS



REVISIONS	DESCRIPTION
DATE	

**Powder Mountain Hidden Lake Yurt**  
 WEBER COUNTY, UTAH

**Site Plan**



**Project Info.**  
 Engineer: J. NATE REEVE, P.E.  
 Drafter: R. HANSEN  
 Begin Date: SEPTEMBER 17, 2012  
 Name: POWDER MOUNTAIN HIDDEN LAKE YURT  
 Number: 6101-01

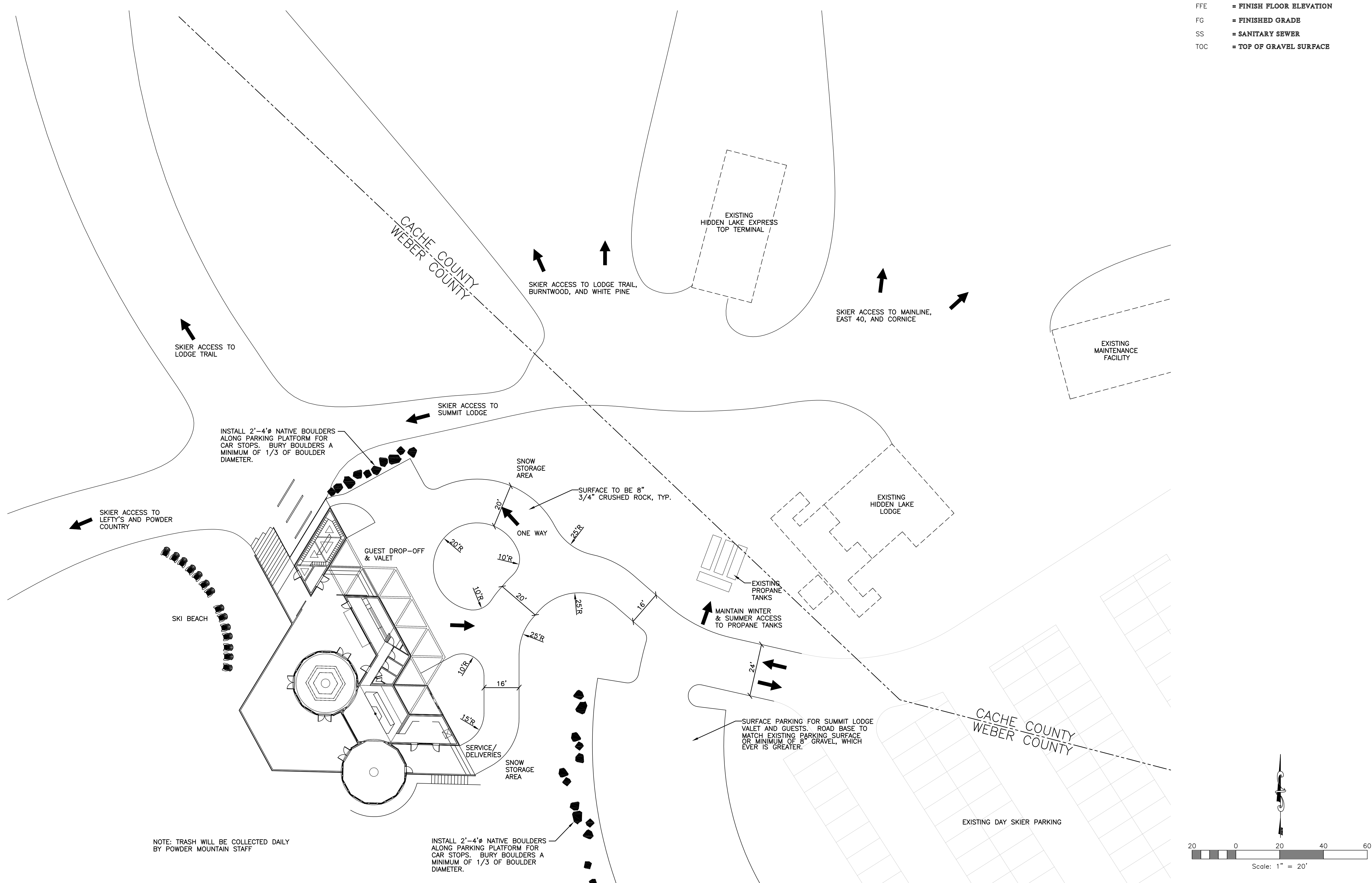

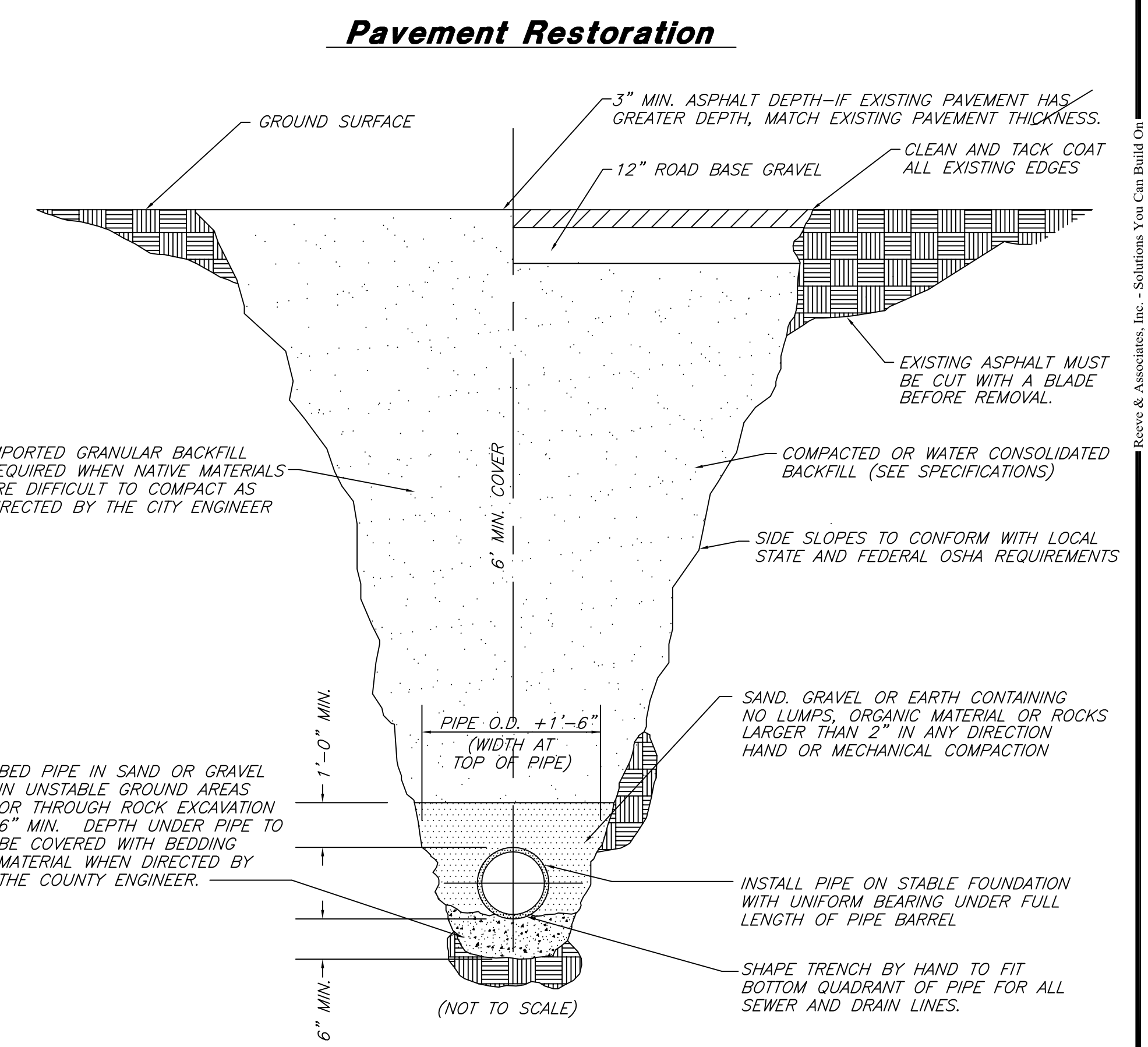
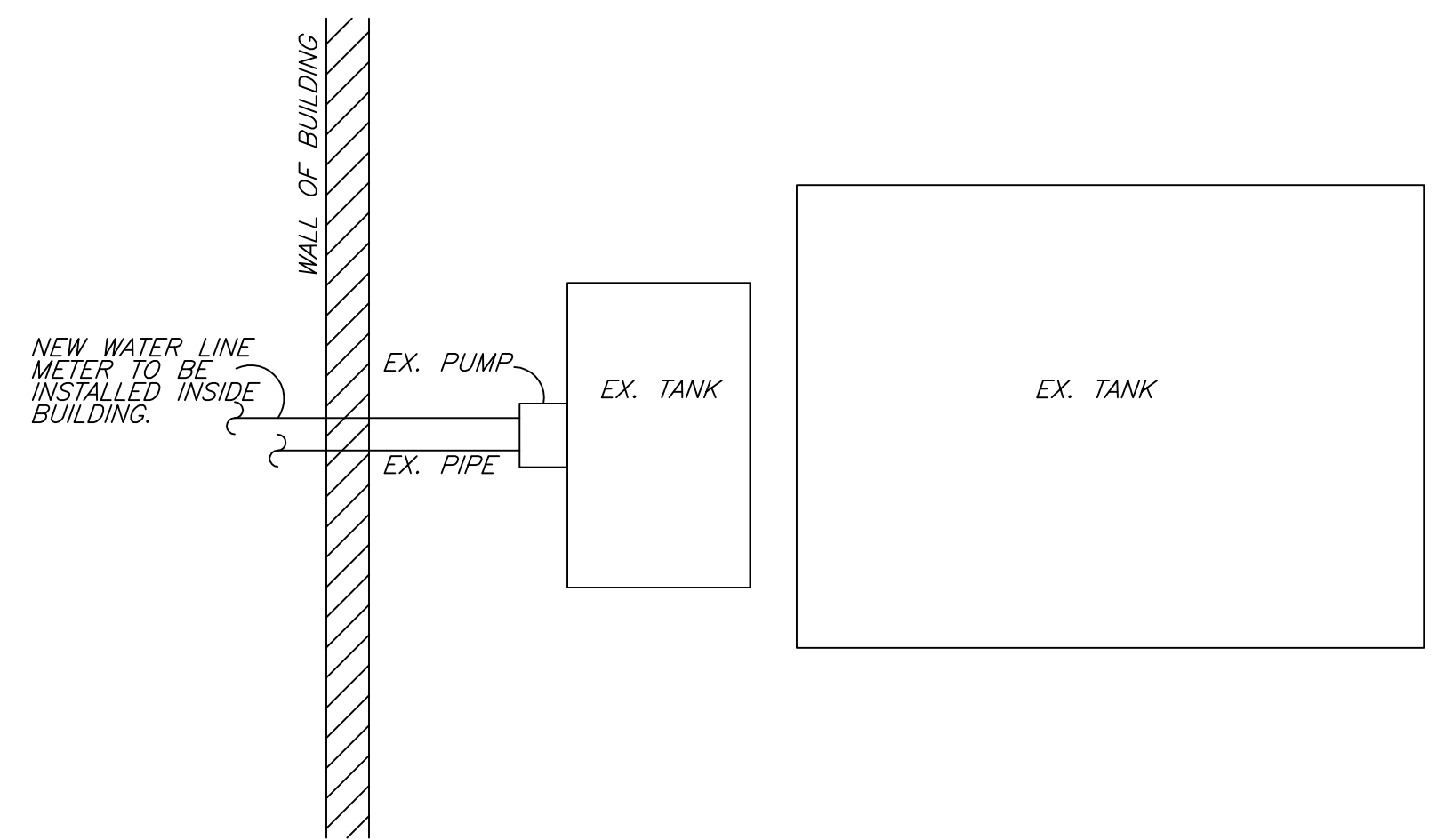
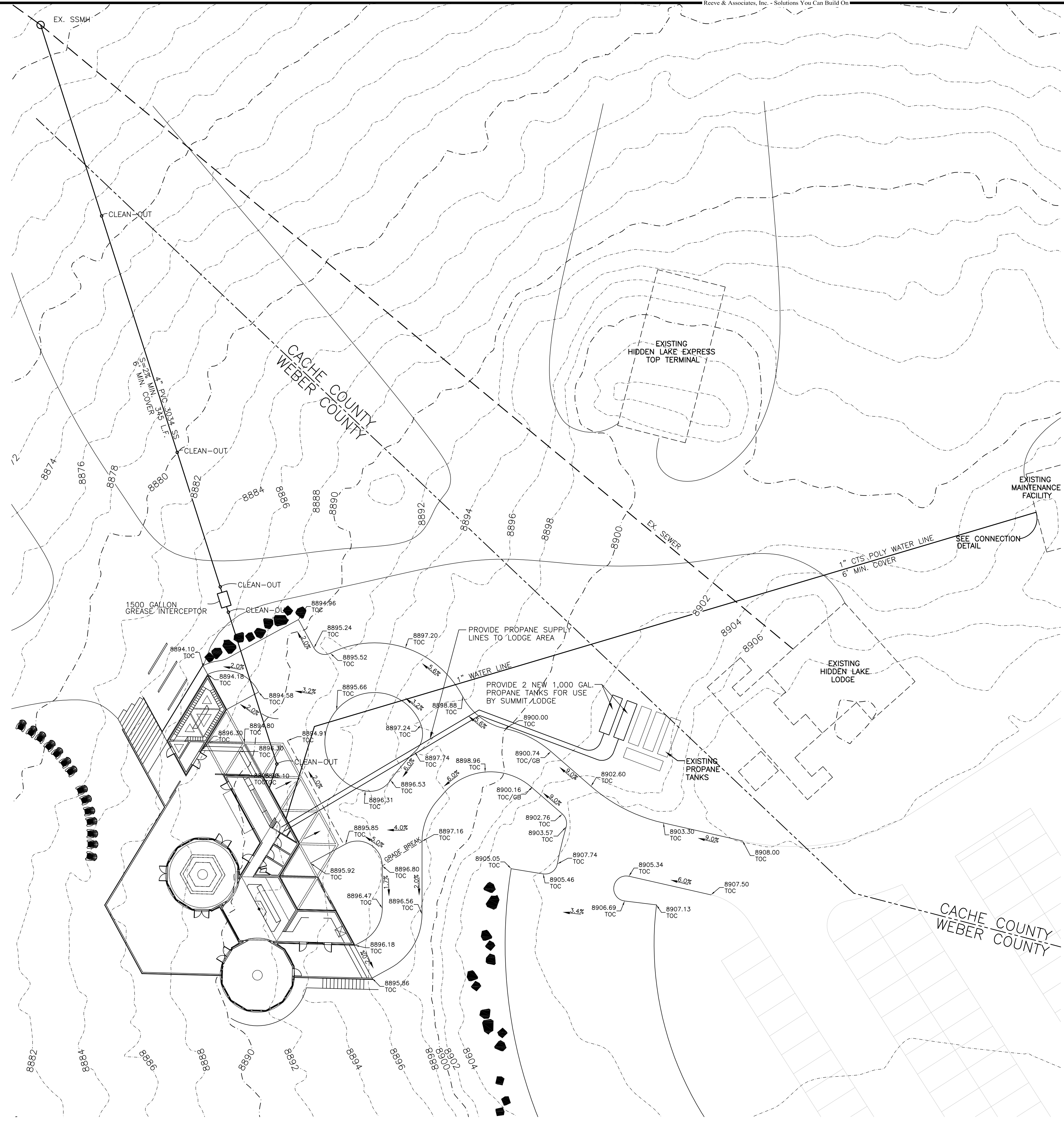

**Typical Trench Section**  
(WATER & SEWER)

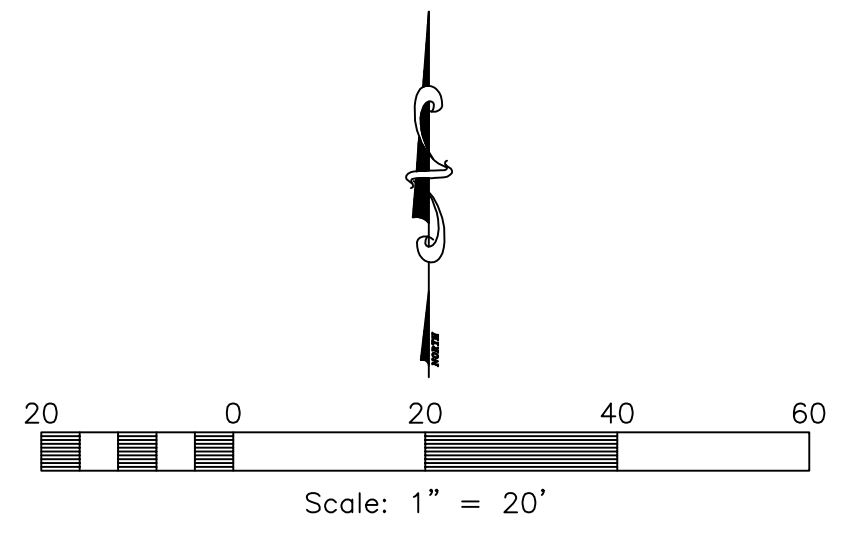

**Reeve & Associates, Inc.**  
RA  
REGISTERED PROFESSIONAL ENGINEER  
STATE OF UTAH  
375328  
J. NATE REEVE

REVISIONS	DESCRIPTION

**Powder Mountain Hidden Lake Yurt**  
WEBER COUNTY, UTAH

**Grading & Utility Plan**

**Project Info.**  
Engineer: J. NATE REEVE, P.E.  
 Drafter: R. HANSEN  
 Begin Date: SEPTEMBER 17, 2012  
 Name: POWDER MOUNTAIN HIDDEN LAKE YURT  
 Number: 6101-01

Sheet **5**  
**3** Sheets

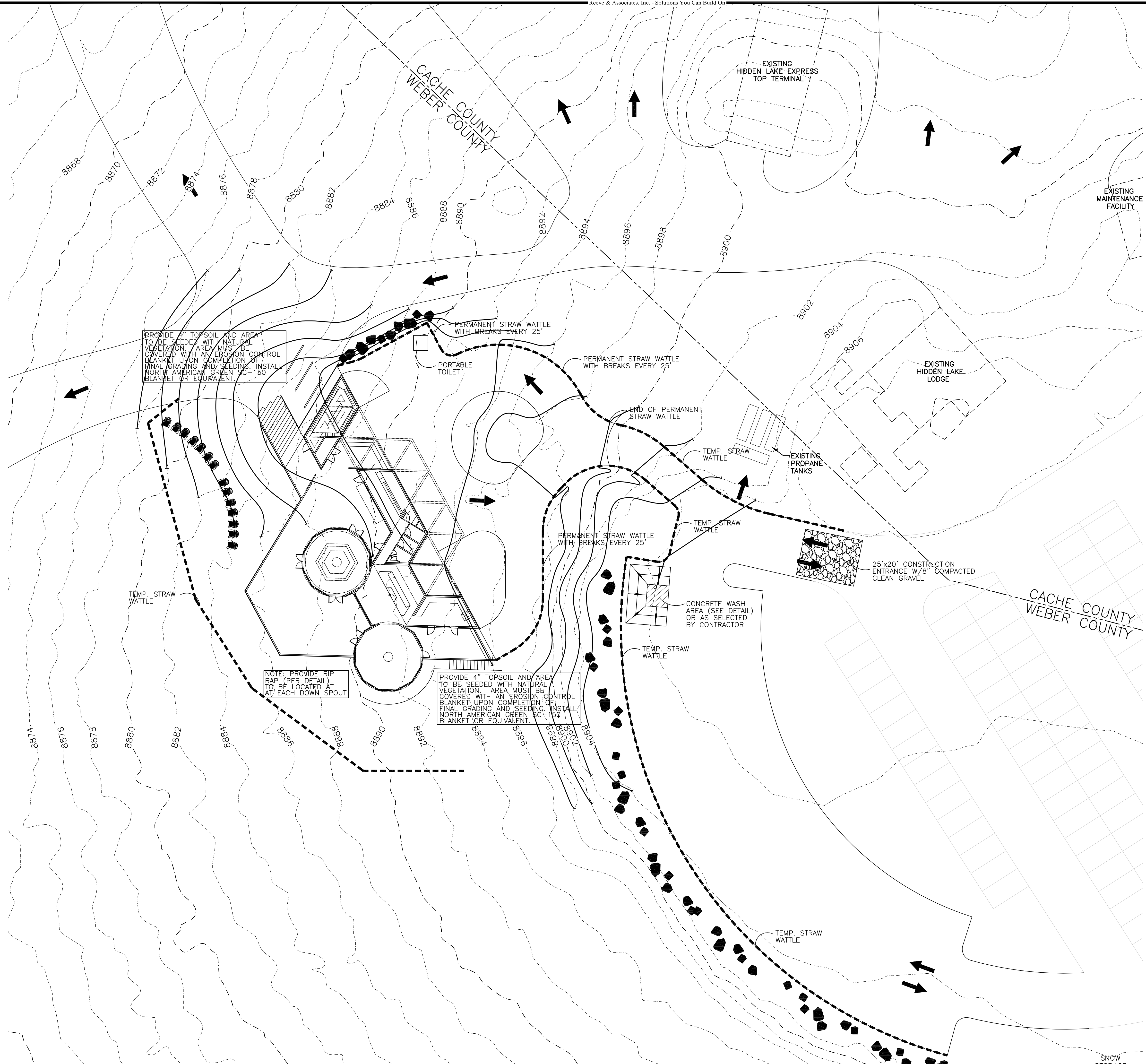

PROVIDE 4" TOPSOIL AND AREA TO BE SEEDER WITH NATURAL VEGETATION. AREA MUST BE COVERED WITH AN EROSION CONTROL BLANKET UPON COMPLETION OF FINAL GRADING AND SEEDING. INSTALL NORTH AMERICAN GREEN SC-150 BLANKET OR EQUIVALENT.

NOTE: PROVIDE RIP RAP (PER DETAIL) TO BE LOCATED AT EACH DOWN SPOUT

PROVIDE 4" TOPSOIL AND AREA TO BE SEEDER WITH NATURAL VEGETATION. AREA MUST BE COVERED WITH AN EROSION CONTROL BLANKET UPON COMPLETION OF FINAL GRADING AND SEEDING. INSTALL NORTH AMERICAN GREEN SC-150 BLANKET OR EQUIVALENT.

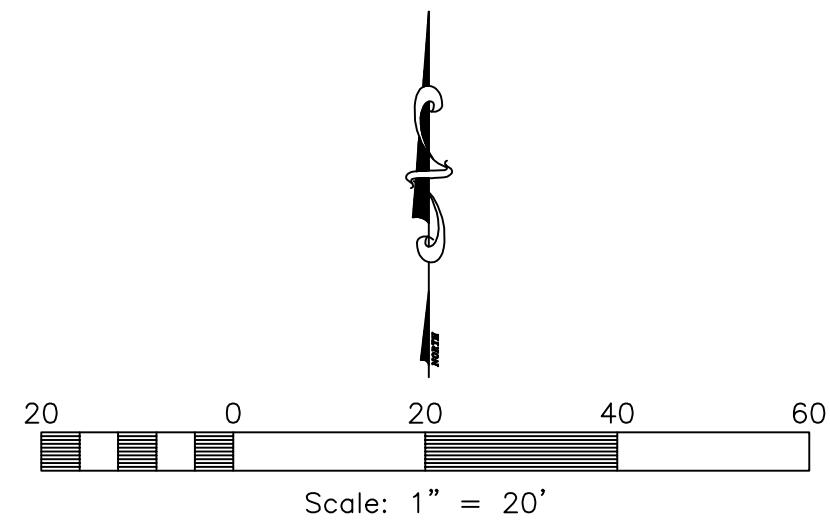

**Reeve & Associates, Inc.**  
 920 CHAMBERS STREET, SUITE #14, OGDEN, UTAH 84403  
 TEL: (801) 621-3100 FAX: (801) 621-2668 www.reeve-associ.com  
 CIVIL ENGINEERS • STRUCTURAL ENGINEERS • LANDSCAPE ARCHITECTS

REVISIONS	DESCRIPTION
DATE	

**Powder Mountain Hidden Lake Yurt**  
 WEBER COUNTY, UTAH

**Storm Water Pollution Protection Plan**

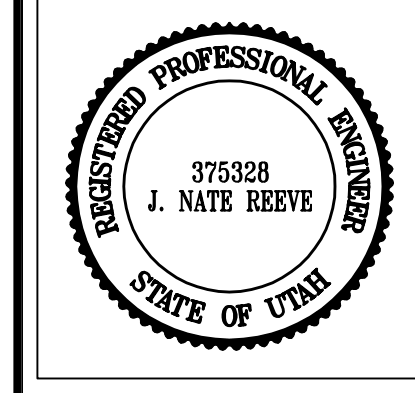

**Project Info.**  
 Engineer: J. NATE REEVE, P.E.  
 Drafter: R. HANSEN  
 Begin Date: SEPTEMBER 17, 2012  
 Name: POWDER MOUNTAIN HIDDEN LAKE YURT  
 Number: 6101-01

**Notes:**

1. Describe all BMP's to protect storm water inlets:  
All storm water inlets to be protected by straw wattle barriers, or gravel bags (see detail).
2. Describe BMP's to eliminate/reduce contamination of storm water from:
  - a. Equipment / building / concrete wash areas:  
To be performed in designated areas only and surrounded with silt fence barriers.
  - b. Soil contaminated by soil amendments:  
If any contaminants are found or generated, contact environmental engineer and contacts listed.
  - c. Areas of contaminated soil:  
If any contaminants are found or generated, contact environmental engineer and contacts listed.
  - d. Fueling area:  
To be performed in designated areas only and surrounded with silt fence.
  - e. Vehicle maintenance areas:  
To be performed in designated areas only and surrounded with silt fence.
  - f. Vehicle parking areas:  
To be performed in designated areas only and surrounded with silt fence.
  - g. Equipment storage areas:  
To be performed in designated areas only and surrounded with silt fence.
  - h. Materials storage areas:  
To be performed in designated areas only and surrounded with silt fence.
  - i. Waste containment areas:  
To be performed in designated areas only and surrounded with silt fence.
  - j. Service areas:  
To be performed in designated areas only and surrounded with silt fence.
3. Construction Vehicles and Equipment:
  - a. Maintenance
    - Maintain all construction equipment to prevent oil or other fluid leaks.
    - Keep vehicles and equipment clean, prevent excessive build-up of oil and grease.
    - Regularly inspect on-site vehicles and equipment for leaks, and repair immediately.
    - Check incoming vehicles and equipment (including delivery trucks, and employee and subcontractor vehicles) for leaking oil and fluids. Do not allow leaking vehicles or equipment on-site.
    - Segregate and recycle wastes, such as greases, used oil or oil filters, antifreeze, cleaning solutions, automotive batteries, hydraulic, and transmission fluids.
  - b. Fueling
    - If fueling must occur on-site, use designated areas away from drainage.
    - Locate on-site fuel storage tanks within a bermed area designed to hold the tank volume.
    - Cover retention area with an impervious material and install in a manner to ensure that any spills will be contained in the retention area. To catch spills or leaks when removing or changing fluids.
    - Use drip pans for any oil or fluid changes.
  - c. Washing
    - Use as little water as possible to avoid installing erosion and sediment controls for the wash area.
    - If washing must occur on-site, use designated, bermed wash areas to prevent waste water discharge into storm water, creeks, rivers, and other water bodies.
    - Use phosphate-free, biodegradable soaps.
    - Do not permit steam cleaning on-site.
5. Spill Prevention and Control
  - a. Minor Spills:  
Minor spills are those which are likely to be controlled by on-site personnel. After contacting local emergency response agencies, the following actions should occur upon discovery of a minor spill:
    - Contain the spread of the spill.
    - If the spill occurs on paved or impermeable surfaces, clean up using "dry" methods (i.e. absorbent materials, cat litter, and / or rags).
    - If the spill occurs in dirt areas, immediately contain the spill by constructing an earth dike. Dig up properly dispose of contaminated soil.
    - If the spill occurs during rain, cover the impacted area to avoid runoff.
    - Record all steps taken to report and contain spill.
  - b. Major Spills:  
On-site personnel should not attempt to control major spills until the appropriate and qualified emergency response staff have arrived at the site. For spills of federal reportable quantities, also notify the National Response Center at (800) 424-8802. A written report should be sent to all notified authorities. Failure to report major spills can result in significant fines and penalties.
6. Post Roadway / Utility Construction
  - a. Maintain good housekeeping practices.
  - b. Enclose or cover building material storage areas.
  - c. Properly store materials such as paints and solvents.
  - d. Store dry and wet materials under cover, away from drainage areas.
  - e. Avoid mixing excess amounts of fresh concrete or cement on-site.
  - f. Perform washout of concrete trucks offsite or in designated areas only.
  - g. Do not wash out concrete trucks into storm drains, open ditches, streets or streams.
  - h. Do not place material or debris into streams, gutters or catch basins that stop or reduce the flow of runoff water.
  - i. All public streets and storm drain facilities shall be maintained free of building materials, mud and debris caused by grading or construction operations. Roads will be swept within 1000' of construction entrance daily, if necessary.
  - j. Install straw wattle around all inlets contained within the development and all others that receive runoff from the development.
7. Erosion Control Plan Notes
  - a. The contractor will designate an emergency contact that can be reached 24 hours a day 7 days a week.
  - b. A stand-by crew for emergency work shall be available at all times during potential rain or snow runoff events. Necessary materials shall be available on site and stockpiled at convenient locations to facilitate rapid construction of emergency devices when rain or runoff is eminent.
  - c. Erosion control devices shown on the plans and approved for the project may not be removed without approval of the engineer of record. If devices are removed, no work may continue that have the potential of erosion without consulting the engineer of record. If deemed necessary erosion control should be reestablished before this work begins.
  - d. Graded areas adjacent to fill slopes located at the site perimeter must drain away from the top of the slope at the conclusion of each working day. This should be confirmed by survey or other means acceptable to the engineer of record.
  - e. All silt and debris shall be removed from all devices within 24 hours after each rain or runoff event.
  - f. Except as otherwise approved by the inspector, all removable protective devices shown shall be in place at the end of each working day and through weekends until removal of the system is approved.
  - g. All loose soil and debris, which may create a potential hazard to offsite property, shall be removed from the site as directed by the Engineer of record of the governing agency.
  - h. The placement of additional devices to reduce erosion damage within the site is left to the discretion of the Engineer of record.
  - i. Desilting basins may not be removed or made inoperable without the approval of the engineer of record and the governing agency.
  - j. Erosion control devices will be modified as need as the project progresses, and plans of these changes submitted for approval by the engineer of record and the governing agency.
8. Conduct a minimum of one inspection of the erosion and sediment controls every two weeks. Maintain documentation on site.

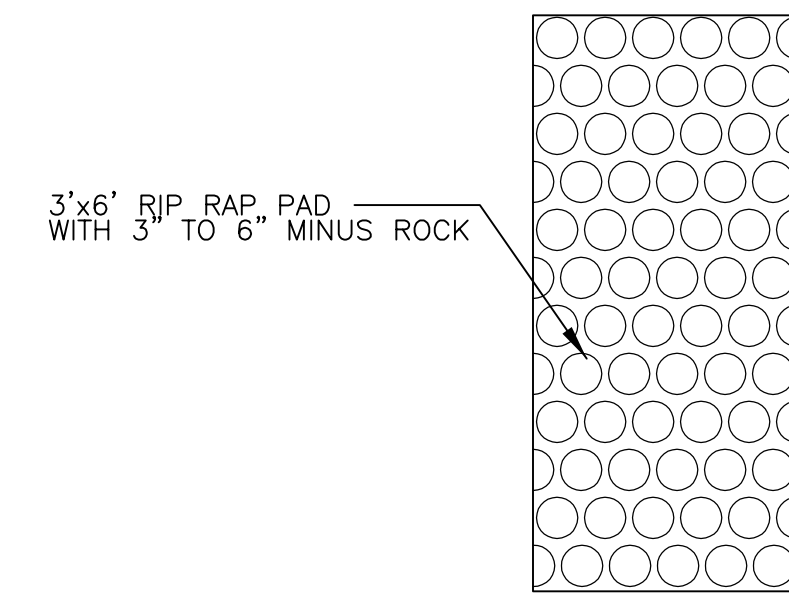
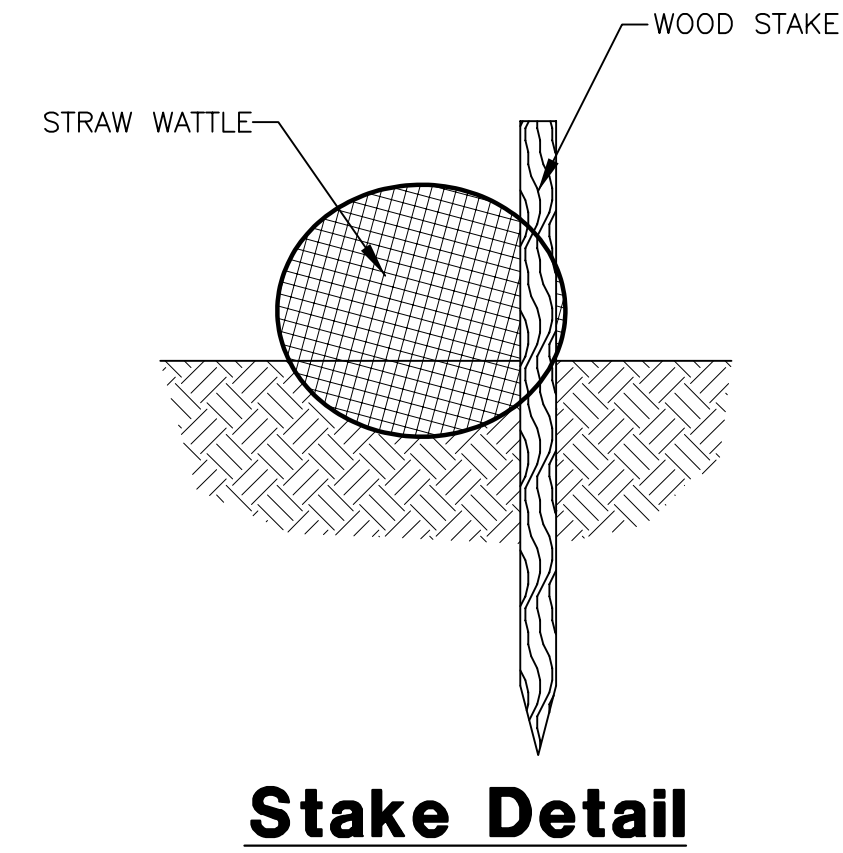
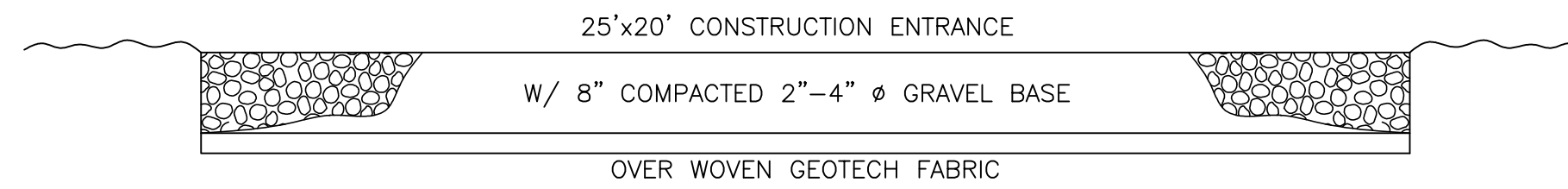
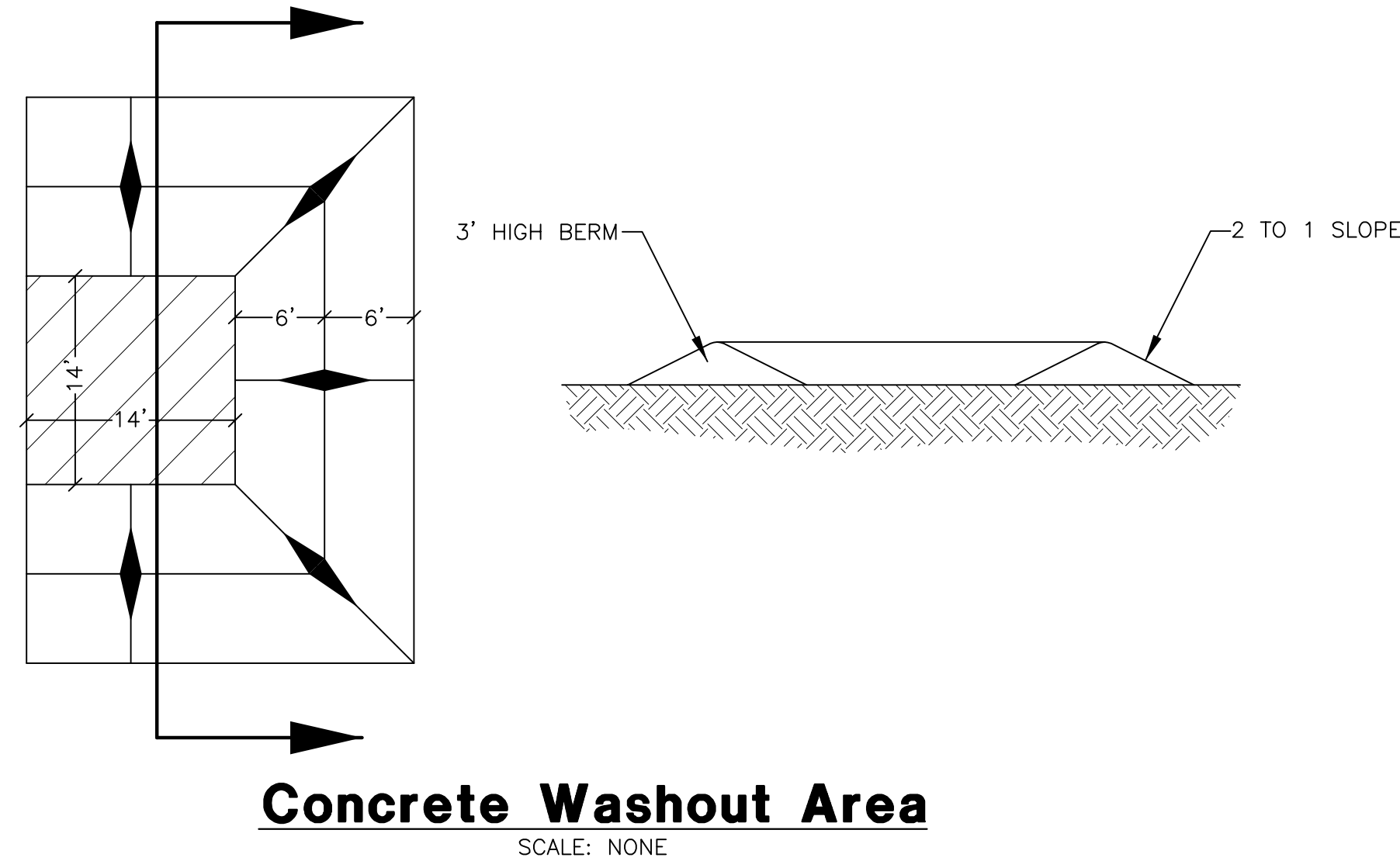

REVISIONS	DESCRIPTION
DATE	

Reeve & Associates, Inc. - Solutions You Can Build On

**Powder Mountain Hidden Lake Yurt**  
WEBER COUNTY, UTAH

**Storm Water Pollution Protection Plan Details**

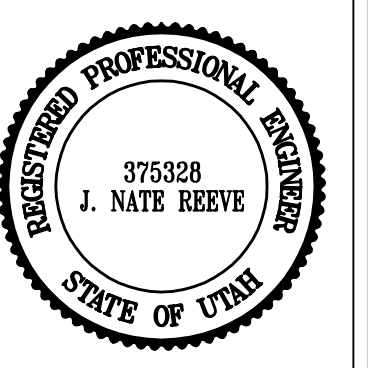

**Project Info.**

Engineer: J. NATE REEVE, P.E.  
 Drafter: R. HANSEN  
 Begin Date: SEPTEMBER 17, 2012  
 Name: POWDER MOUNTAIN HIDDEN LAKE YURT  
 Number: 6101-01