(This SWPPP Template is for the **Common Plan** Permit Only, and
does **NOT** address SWPPP requirements found in the CGP.)

Common Plan SWPPP for

Okeefe Res.

3911 N. Zermatt St.

Eden, UT 84310

Land To Sky Construction Inc.

5018 E. Whispering Pines Lane

Eden, UT 84310

Contractor Name (if not the same as Owner)

Contractor Street Address

Contractor City, State, Zip

Date

10/14/2018



1. Project Information

Project Name: Okeefe Res.
Address: 3911 N. Zermatt St.
City: Eden **State:** UT **Zip:** 84310
Latitude: 41.32989
Longitude: -111.81228
UPDES Permit Tracking Number: UTRH89451

Owner: Mark Heyvaert & Ellen Okeefe
Contact Person: Kirt L. Bovero
Address: 5018 E. Whispering Pines Lane
City: Eden **State:** UT **Zip:** 84310
Telephone Number: 801-497-1746
Email Address: landtoskyconstruction@gmail.com

General Contractor: Land to Sky Construction Inc..
Contact Person: Kirt L. Bovero
Address: 5018 E. Whispering Pines Lane
City: Eden. **State:** UT **Zip:** 84310
Telephone Number: 801-497-1746
Email Address: landtoskyconstruction@gmail.com

Answering "no" to the two questions below means the project is not eligible for this permit.

Is the project in Indian Country? Yes No
Is the project a residential building on a single lot and disturbing one acre or less? Yes No

2. Pollution Sources/Best Management Practices

Answer yes or no whether the following features are located at your site. If yes, select the BMP(s) that will be used to protect each feature. If no, continue to the next question. Attach necessary illustrated details for proper installation in Appendix G, and show locations of all controls on Site Map in Appendix A.

- 2.1 Is there a SWPPP sign on site?** (see permit part 1.10) Yes **Required**
The sign must include the UPDES tracking number, the owner or general contractor name, phone number and email, and if the SWPPP is on-line, instructions on how to view it. The size requirement is to be readable from a publicly accessible point.
- 2.2 Will there be construction dewatering on the site?** (see permit part 2.7) Yes No
BMP(s): Dewatering of the construction area is needed and a separate dewatering permit has been obtained to treat and discharge water. *Construction Dewatering (if discharged offsite) must be covered by UPDES Permit UTG070000.*
 Water from the dewatering of the construction area will be infiltrated on site.
- 2.3 Will there be non-storm water discharges on the site?** (see permit part 1.3) Yes No
Allowable discharges include: Flushing of drinking water or irrigation water (not including wash or cleaning waters), water used for dust control, spring water or groundwater not exposed to construction activities, water from emergency fire-fighting activities, and water from foot drains not exposed to construction activities. (see permit part 2.4.5 & 2.9).
Please list all anticipated non-storm water discharges: [Click here to enter text.](#)
What will you do to manage the non-storm water discharges? *Please list direct discharges, contained non-storm water discharges, and discharges that are treated separately.*
BMP(s): All non-storm water discharges are listed as allowable per permit part 1.3 and discharged

- All non-storm water discharges that are not allowed are properly contained (see questions 2.12 and 2.16)
- All non-storm water discharges that are contaminated with sediment only (free of chemicals, oils, etc.) will be treated in a sediment basin or equivalent (see permit part 2.8.1).
- Other: [Click here to enter text.](#)

2.4 Is it possible for the total area of disturbance to be phased, minimizing the total exposure of disturbed soil at one time? (see permit part 2.3.1) **Yes** **No**
If disturbance can be minimized please show the locations on the site map and summarize (here) where disturbances will be delayed for some of the disturbed area: [Click here to enter text.](#)

2.5 What perimeter controls will be used to prevent sediment from leaving the site? (permit part 2.1.2 & 2.3)
BMP(s): Silt Fence Berms
 Vegetative Buffer Cut-Back-Curb
 Staked straw Wattles (Fiber Rolls) Weighted Wattles
 Other: [Click here to enter text.](#)

2.6 Are surface waters located within 30 feet of your project's earth disturbances? **Yes** **No**
Note: A 30' natural vegetative buffer MUST be maintained by water bodies. If a buffer less than 30' is used, you must demonstrate that the additional controls offer the same protection as a 30' natural vegetative buffer, and select the reason for exemption below. (see permit part 2.3.5)
BMP(s): 30' Natural Vegetative Buffer
If less than 30' Natural Vegetative Buffer select additional Controls:
 2 Silt Fence Barrier 2 Straw Wattle Barriers (Fiber Roll)
 Other: [Click here to enter text.](#)

2.7 Are there critical or sensitive areas (such as preservation of the drip lines around trees, wetlands, buffer zones by water bodies, etc.) located on or adjacent to the site? (see permit part 2.2) **Yes** **No**
BMP(s): Separate and isolate with environmental fencing
 Other: [Click here to enter text.](#)

2.8 What track out control will be used to prevent dirt from being tracked on streets as vehicles leave the site? (see permit part 2.4.1)
BMP(s): Track Out Pad Cobble Gravel
 Rumble Strips Wash Down Pad Delivery Pad
 Restricted Site Access Selective Access During Dry Weather (Dry soil)
 Other: [Click here to enter text.](#)

2.9 Do you have storm drain inlets on or down gradient of this site? (see permit part 2.1.3) **Yes** **No**
Protection must address the curb inlet opening (throat) as well as the grate.
Where is/are the nearest downstream inlet(s) and how will you protect them: [Click here to enter text.](#)
BMP(s): Rock/Sand-filled Bags Drop Inlet Bags
 Filter Fabric Gravel or Sand filled Wattles
 Proprietary inlet devices
 Other: [Click here to enter text.](#)

2.10 Will curb ramps be used at the site? (see permit part 2.4.2) Yes No
If curb ramps are used it must be done with material [not dirt] that will not wash away in storm water.
BMP(s): Crushed Rock Wood/Steel Ramps
 Other: Click here to enter text.

2.11 Will there be stockpiles or spoil piles on the site? Yes No
Note: Select "Contained by other BMP" if another BMP on your site will contain runoff from the stockpiles. Materials that can be transported with precipitation must not be placed in the street. (see permit part 2.1.1)
BMP(s): Surrounded by Silt Fence Surrounded by Staked Straw Wattles
 Covered with Tarp Temporary – Removed same day
 Contained by other BMP. Explain: Click here to enter text.
 Other: Click here to enter text.

2.12 Does the project include installation of concrete, masonry, stucco, and paint (water based) work in this project? (see permit part 2.4.5 & 2.9.1) Yes No
Wash water must be contained, the solids dried, and disposed of at a landfill.
BMP(s): Lined Depression Steel Dumpster
 Regional Washout (per development)
 Other: Click here to enter text.

2.13 How will solid waste be dealt with on the site? (see permit part 2.4.3)
Light trash in uncovered dumpsters can blow out and scatter with wind and rain may fall on uncovered leachable material in the dumpster and leak out the bottom causing pollutants to escape.
BMP(s): Bag Lightweight Trash Leak Proof Dumpsters
 Receptacles with Lids Other: Click here to enter text.

2.14 Will there be a need to dispose of solvents, oil, fuel, etc. liquid waste? (see permit part 2.9) Yes No
BMP(s): Contained and Removed from the site Collected for Reuse
 Other: Click here to enter text.

2.15 How will sanitary waste be handled on the site? (see permit part 2.4.4)
BMP(s): Portable Toilet(s) (must be staked down on dirt surface & 10' from curb)
 Onsite or Adjacent Indoor Bathrooms
 Portable Toilet Secondary Containment (secured down with straps to heavy weights)
 Other: Click here to enter text.

2.16 How will you minimize the discharge of pollutants from spills and leaks? (see permit part 2.8.3)
BMP(s): Use of drip pans Offsite fueling, and maintenance
 Spill kit Spill response plan.
 Other: Click here to enter text.

2.17 Will there be a need to store construction materials on site? (see permit 2.8.2) Yes No
Minimize the exposure of materials with a pollution risk (certain building and landscaping materials, fertilizers, pesticides, herbicides, detergents).
BMP(s): Covering Erodible or Liquid Materials Secondary Containment
 Strategic Storage and Staging Stored off-site
 Enclose them in a weather proof shed.
 Other: Click here to enter text.

2.18 Does your site have steep slopes (greater than 70%)? (see permit part 2.3.2) Yes No
BMP(s): Erosion Control Blanket Avoid Disturbance on slope
 Seeding Hydroseed
 Mulch Tackifiers
 Other: [Click here to enter text.](#)

2.19 Are there site conditions that cause storm water flows with highly erosive velocities? (see permit parts 2.3.3 and 2.3.4) Yes No
Flows must be controlled to minimize sediment transport.
BMP(s): Gravel Check Dam Straw Wattles (Fiber Rolls) Check Dam
 Divert Flows around the Site Armored channel (riprap, geotextile, other)
 Other: [Click here to enter text.](#)

2.20 How will you reduce storm water volume to minimize sediment transport, channel and stream bank erosion? (see permit parts 2.3.4 and 2.3.3)
BMP(s): Utilize basin, depression storage of storm water, cut back curb, or other to hold and infiltrate.
 Prevent heavy equipment (as much as possible) from compacting soil so storm water will infiltrate easier.
 Rip soil after heavy equipment has caused compaction.
 Other: [Click here to enter text.](#)

2.21 Is there a need for dust control on the site (regulatory or for practical reasons)? Yes No
BMP(s): Wetting with Water Cover dirt piles with a tarp
 Use Mag chloride, Calcium Chloride or Lignan Sulfonate
 Stabilize surface with mulch, gravel or other surface cover
 Other: [Click here to enter text.](#)

2.22 Will there be disturbed areas on the site that will need to be temporarily stabilized before the project is completed? (see permit part 2.6) Yes No
Places that are disturbed and then left for over 14 days with no activity, must be temporarily or permanently stabilized.
BMP(s): Bark or other mulch Hydro-mulch Seeding
 Tackifier Staked netting with straw mulch
 Other: [Click here to enter text.](#)

2.23 Will the house be sold without any landscaping? Yes No
If so, how will you leave the site for the new home owner so sediment will be contained on site until the home owner completes landscaping? (the permit can be terminated when the owner occupies the house even though the site is not stabilized).
BMP(s): Mulching/Hydro-mulching Swales Silt Fence
 Wattles Cut-Back-Curb Seeding
 Vegetated Buffer Grade Front-Yard Lower than Sidewalk
 Other: [Click here to enter text.](#)

3. Sequence of Construction Activity

Type of Construction Activity	Approximate Date Range
Start/End of the Project	10/16/2018 10/16/2018
Excavation activities	10/16/2018
Foundation/Footings	10/19/2018
Backfill	11/5/2018
Erection of Building	12/1/2018
Utility Lines installed (you may need to separate this into Plumbing lines, electrical lines, gas lines, water lines, Internet lines, etc.)	11/5/2018
Insert more rows for any stage that should be included	
Landscaping (if the house is sold or occupied by owner with landscaping, if not landscaping should not be included)	landscaping not included

4. Site Map

On a blank page (or include a page from the architectural drawings that show site layout and dimensions), please draw a map (and place this map in Appendix A) showing the layout of the site including locations of:

1. boundaries of project/property
2. boundaries of disturbance (including areas outside of property boundaries)
3. show slopes on site (if there are steep areas show steep areas)
4. location of structures/facilities
5. locations of :
 - a. stockpiles for soils and materials
 - b. construction supplies
 - c. portable toilets
 - d. garbage/trash containers
 - e. egress points/track out pads
 - f. concrete washout pits or containers
6. water bodies, wetlands, natural vegetative buffers
7. placement of all BMPs, perimeter, erosion control, sediment control, inlet protection, etc.
8. storm water inlets and storm water discharge points (where storm water drains off the site)
9. areas that will be temporarily or permanently stabilized on the site
10. areas where disturbances will be delayed to minimize total exposed surface at one time.

5. Potential Sources of Pollutants

Potential sources of sediment to storm water runoff:

- Clearing and grubbing operations
- Grading and site excavation operations
- Vehicle tracking
- Topsoil stripping and stockpiling
- Landscaping operations

Potential pollutants and sources, other than sediment, to storm water runoff:

- Combined Staging Area—small fueling activities, minor equipment maintenance, sanitary facilities, and hazardous waste storage.
- Materials Storage Area—general building materials, solvents, adhesives, paving materials, paints, aggregates, trash, and so on.
- Construction Activity—paving, curb/gutter installation, concrete pouring/mortar/stucco, and building construction
- Concrete Washout Area

For all potential construction site pollutants, see Table 2 below.

Table 2. Potential construction site pollutants. Circle/highlight all that applies to your site and in the last column identify pollution prevention measures to minimize their discharge.

Material/Chemical	Storm Water Pollutants	Common Location*	Pollution Prevention Methods
Pesticides (insecticides, fungicides, herbicides, rodenticide)	Chlorinated hydrocarbons, organophosphates, carbamates, arsenic	Herbicides used for noxious weed control	None
Fertilizer	Nitrogen, phosphorous	Newly seeded areas	None
Plaster	Calcium sulphate, calcium carbonate, sulfuric acid	Building construction	None
Cleaning solvents	Perchloroethylene, methylene chloride, trichloroethylene, petroleum distillates	No equipment cleaning allowed in project limits	None
Asphalt	Oil, petroleum distillates	Streets and roofing	
Concrete	Limestone, sand, pH, chromium	Curb and gutter, building construction	Lined Hole
Glue, adhesives	Polymers, epoxies	Building construction	Disguard appropriately
Paints	Metal oxides, Stoddard solvent, talc, calcium carbonate, arsenic	Building construction	Disguard appropriately
Curing compounds	Naphtha	Curb and gutter	

Wood preservatives	Stoddard solvent, petroleum distillates, arsenic, copper, chromium	Timber pads and building construction	Disguard appropriately
Hydraulic oil/fluids	Mineral oil	Leaks or broken hoses from equipment	None
Gasoline	Benzene, ethyl benzene, toluene, xylene, MTBE	Secondary containment/staging area	
Diesel Fuel	Petroleum distillate, oil & grease, naphthalene, xylenes	Secondary containment/staging area	
Kerosene	Coal oil, petroleum distillates	Secondary containment/staging area	
Antifreeze/coolant	Ethylene glycol, propylene glycol, heavy metals (copper, lead, zinc)	Leaks or broken hoses from equipment	
Sanitary toilets	Bacteria, parasites, and viruses	Staging area	

*(Area where material/chemical is used on-site)

6. Spill Prevention and Response Plan

Describe the spill prevention and control plan to include ways to reduce the chance of spills, stop the source of spills, contain and cleanup spills, dispose of materials contaminated by spills, and train personnel responsible for spill prevention and control. Additionally, fill in all **BLUE** fields below.

Spill Plan:

Store Hazardous substances not used daily in cabinets, or in designated areas. All Chemicals that transferred from larger to smaller containers must be used of a funnel or spigot. All Hazard substances containers should be closed while not in use; Use drip pans or other collection devices to contain drips or leaks from dispensing containers or equipment; Implement Preventative maintenance activities to reduce the potential for release from equipment:

Immediately clean up and properly manage all small spills or leaks; Periodically inspect equipment and hazardous substances storage areas to ensure leaks and spills are not occurring; Use signage to identify hazardous substance storage or waste collection areas; Keep all work areas and hazardous substance storage areas clean and in good general condition.

Any discharges in 24 hours equal to or in excess of the reportable quantities listed in 40 CFR 117, 40 CFR 110, and 40 CFR 302 will be reported to the National Response Center and the Division of Water Quality (DWQ) as soon as practical after knowledge of the spill is known to the permittee. The permittee shall submit within 14 calendar days of knowledge of the release a written description of: the release (including the type and estimate of the amount of material released), the date that such release occurred, the circumstances leading to the release, and measures taken and/or planned to be taken to the Division of Water Quality (DWQ), 288 North 1460 West, P.O. Box 144870, Salt Lake City, Utah 84114-4870. The Storm Water Pollution Prevention Plan must be modified within 14 calendar days of knowledge of the release to provide a description of the release, the circumstances leading to the

release, and the date of the release. In addition, the plan must be reviewed to identify measures to prevent the reoccurrence of such releases and to respond to such releases, and the plan must be modified where appropriate.

Agency	Phone Number
National Response Center	(800) 424-8802
Division of Water Quality (DWQ) 24-Hr Reporting	(801) 538-6146; (801) 536-4123
Utah Department of Health Emergency Response	(801) 580-6681
Weber Fire District	(801) 782-3580

Minimum spill quantities requiring reporting:

Material	Media Released To	Reportable Quantity
Engine oil, fuel, hydraulic & brake fluid	Land	25 gallons
Paints, solvents, thinners	Land	100 lbs (13 gallons)
Engine oil, fuel, hydraulic & brake fluid	Water	Visible Sheen
Refrigerant	Air	1 lb
Antifreeze, battery acid, gasoline, engine degreasers	Air, Land, Water	100 lbs (13 gallons)

Emphasis to:

- 1st Priority: Protect all people (including onsite staff)
- 2nd Priority: Protect equipment and property
- 3rd Priority: Protect the environment

1. Make sure the spill area is safe to enter and that it does not pose an immediate threat to health or safety of any person.
2. Check for hazards (flammable material, noxious fumes, cause of spill) – if flammable liquid, turn off engines and nearby electrical equipment. If serious hazards are present leave area and call 911. LARGE SPILLS ARE LIKELY TO PRESENT A HAZARD.
3. Stop the spill source and contain flowing spills immediately with spill kits, dirt or other material that will achieve containment.
4. Call co-workers and supervisor for assistance and to make them aware of the spill and potential dangers
5. If spilled material has entered a storm sewer, regardless of containment; contact the City Storm Water Division.
6. Cleanup all spills (flowing or non-flowing) immediately following containment. Clean up spilled material according to manufacturer specifications, for liquid spills use absorbent materials AND DO NOT FLUSH AREA WITH WATER.
7. Properly dispose of cleaning materials and used absorbent material according to manufacturer specifications.
8. Report the reportable quantity to the Weber Morgan Health Department.

Emergency Numbers

Utah Hazmat Response Officer 24 hrs	(801)-538-3745
Weber County Sheriff Department	(801)-778-6600

7. SWPPP, Inspections and Corrective Action Reports

Inspection Schedule and Procedures: The permit requires inspections once a week (see permit Part 3). You must list and provide details of your BMPs in Appendix G. Inspection reports require reporting on BMPs and how effective they are (download inspection reports from the DWQ construction storm water website under the Common Plan Permit). You may be required to maintain, modify, remove, or apply/install more or different BMPs to control pollutants on the site. Please number your BMPs in Appendix G and refer to those numbers on your inspection reports and corrective action reports when you inspect or report on them.

Describe the general procedures for correcting problems when they are identified. Include responsible staff and time frames for making corrections:

Check all BMP's to see if working properly, if not fix all necessary problems daily; Clean streets daily fix any foreseen problems.

Inspections and Corrective Actions: All inspections and corrective actions must be logged using the "Inspection/Correction Action Log" attached in Appendix E. The log should be filled out completely for each BMP.

8. Training of Sub-Contractors

All sub-contractors, installers of utility connections, and others that perform activities that are affected by permit requirements will be informed about permit requirements that pertain to their scope of work.

Sub-Contractors that have been informed:

Contractor	Date	Topic(s) Covered	Initials of Trainer
Excavator			
Gas utilities			
Plumbing connection			
Electrical connection			
Concrete foundation walls			
Concrete flat work			
Landscaper			
Other: Click here to enter text.			
Other: Click here to enter text.			
Other: Click here to enter text.			
Other: Click here to enter text.			

9. Changes to the SWPPP

All changes to this SWPPP must be redlined, dated, and initialed in the SWPPP document and on the site map.

10. Record Keeping

The following items should be kept at the project site available for inspectors to review:

1. A copy of the Common Plan Permit (Appendix B)
2. The signed and certified NOI form (Appendix C)
3. Inspection reports (Appendix E)

11. Delegation of Authority (if any)

Duly Authorized Representatives or Positions:

Company/Organization: Company of Representative.

Name: Authorized Representative Name.

Position: Representative Title.

Address: Click here to enter text.

City: Click here to enter text.

State: State

Zip: Zip Code

Telephone: (XXX) XXX-XXXX

Fax/Email: (XXX) XXX-XXXX

Owner/General Contractor Signature: _____ Date: _____

Additional Duly Authorized Representatives or Positions:

Company/Organization: Company of Representative.

Name: Authorized Representative Name.

Position: Representative Title.

Address: Click here to enter text.

City: Click here to enter text.

State: State

Zip: Zip Code

Telephone: (XXX) XXX-XXXX

Fax/Email: (XXX) XXX-XXXX

Owner/General Contractor Signature: _____ Date: _____

12. Discharge Information

Does your project/site discharge storm water into a Municipal Separate Storm Sewer System (MS4)?

Yes No

Municipal Storm Drain System receiving the discharge from the construction project: Click here to enter text.

SWPPP Appendices

Ensure the following documentation is attached to the SWPPP:

Appendix A: SWPPP Site Maps

Appendix B: Common Plan Permit

Appendix C: Notice of Intent (NOI), and a copy of the NOT form unless you plan to terminate the permit on-line

Appendix D: Daily Site Check Log

Appendix E: Inspection Reports and Corrective Actions

Appendix F: Additional Information (i.e. permits such as local permits, dewatering, stream alteration, wetland, and out of date SWPPP documents, delegation of authority forms, etc.)

Appendix G: BMP Specifications and Details (label BMPs to match the sections identified in this document.)

APPENDIX A: SWPPP Site Maps

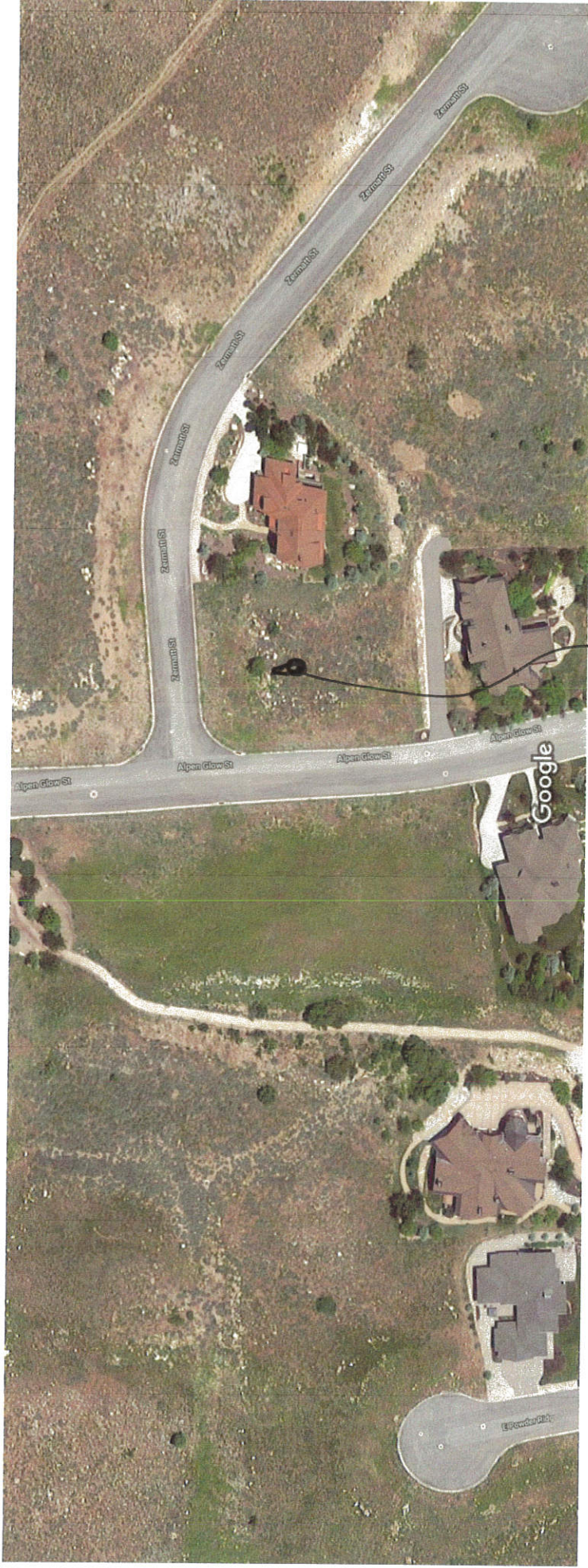

Imagery ©2018 Google, Map data ©2018 Google 50 ft

3911 N. Zeematt st.
 Eden, UT. 84310

Latitude 41,32989
 Longitude -111.81228



Utah



Photos

APPENDIX B: Common Plan Permit

Find the permit on

<https://deq.utah.gov/legacy/permits/water-quality/utah-pollutant-discharge-elimination-system/docs/2016/02feb/updes-common-plan.pdf>

General Permit for Storm Water Discharges from Construction Activities
STATE OF UTAH, DEPARTMENT OF ENVIRONMENTAL QUALITY,
DIVISION OF WATER QUALITY

General Storm Water Permit for Construction Activity
Connected with Single Lot Housing Projects
Utah Pollution Discharge Elimination System Permit No. UTRH00000
(Common Plan Permit)

This Permit is issued in compliance with the provisions of the Utah Water Quality Act (Utah Code Annotated 19-5, as amended) the federal Water Pollution Control Act (33 United States 1251 et. seq., as amended by the Water Quality Act of 1987, Public Law 100-4), and the rules and Regulations made pursuant to those statutes.

This permit applies to "construction activity" for a single lot disturbing a total of one acre or less and for construction activities related to residential dwellings. A single lot covered by this permit is part of a common plan of development or sale (see definitions in Part 6).

Issuance of this permit does not authorize any permittee to violate water quality standards. The permittee shall develop best management practices (BMPs) and engage in activities that will protect water quality during the construction project.

This permit shall become effective on February 1, 2016.

This permit and the authorization to discharge expire at midnight on January 31, 2021.

Signed this 20 day of January, 2016

Walter L. Baker, P.E.
Director



DWQ-2016-002081

JS

TABLE OF CONTENTS

1. COVERAGE UNDER THIS PERMIT.....	1
1.1. <u>Coverage Limitations</u>	1
1.2. <u>Discharges Allowed</u>	1
1.3. <u>Non-Storm Water Discharges</u>	1
1.4. <u>How to Obtain Permit Coverage</u>	1
1.5. <u>Signature on the NOI</u>	2
1.6. <u>Permit Renewal</u>	2
1.7. <u>Start and end of Permit Coverage</u>	2
1.8. <u>Notice of Termination</u>	3
1.9. <u>Water Quality</u>	3
1.10. <u>Requirement to Post a Notice of Permit Coverage</u>	3
2. POLLUTION PREVENTION REQUIREMENTS.....	4
2.1. <u>Structural Controls</u>	4
2.2. <u>Protection of Critical or Sensitive Areas</u>	4
2.3. <u>Managing the Site to Minimize Sediment Transport Off Site</u>	4
2.4. <u>Good Housekeeping Measures</u>	5
2.5. <u>Soil Compaction/Top Soil</u>	6
2.6. <u>Stabilization Requirement</u>	6
2.7. <u>Construction Dewatering</u>	7
2.8. <u>Pollution Prevention Measures</u>	7
2.9. <u>Prohibited Discharges</u>	7
3. SELF-INSPECTION REQUIREMENTS.....	9
3.1. <u>Inspector Qualifications</u>	9
3.2. <u>Self-Inspections</u>	9
3.3. <u>Weekly Self-Inspection Requirements</u>	9
3.4. <u>Weekly Inspection Reports</u>	10
3.5. <u>Corrective Action</u>	10
4. STORM WATER POLLUTION PREVENTION PLAN (SWPPP).....	11

General Storm Water Permit for Construction Activity Connected with Single Lot Housing Projects
UPDES Permit No. UTRH00000

4.1. <u>SWPPP Requirement</u>	11
4.2. <u>Contents of a SWPPP</u>	11
5. STANDARD PERMIT CONDITIONS.....	14
5.1. <u>Duty to Comply</u>	14
5.2. <u>Duty to Reapply</u>	14
5.3. <u>Need to Halt or Reduce Activity not a Defense</u>	14
5.4. <u>Duty to Mitigate</u>	14
5.5. <u>Duty to Provide Information</u>	14
5.6. <u>Other Information</u>	14
5.7. <u>Oil and Hazardous Substance Liability</u>	15
5.8. <u>Property Rights</u>	15
5.9. <u>Severability</u>	15
5.10. <u>Record Retention</u>	15
5.11. <u>Addresses</u>	15
5.12. <u>State Laws</u>	15
5.13. <u>Proper Operation and Maintenance</u>	15
5.14. <u>Inspection and Entry</u>	15
5.15. <u>Reopener Clause</u>	16
5.16. <u>Signatory Requirements</u>	16
6. DEFINITIONS	18

General Storm Water Permit for Construction Activity Connected with Single Lot Housing Projects
UPDES Permit No. UTRH00000

1. COVERAGE UNDER THIS PERMIT. Conditions for coverage under this permit.

1.1. Coverage Limitations. A project site (see definition of a project site in Part 6) is eligible for this permit if it meets the following requirements:

1.1.1. It is found within the State of Utah but is not in Indian Country,

1.1.2. The construction activity is related to residential building on an individual lot or parcel.

1.1.3. It disturbs a total of one acre or less over the duration of the construction project,

1.1.4. *Multiple site coverage*:

1.1.4.a. This permit may apply to multiple lots with the contingency that each lot be covered under a different permit tracking number (separate permit coverage for each lot). Lots do not necessarily need to be located within the same sub-division.

1.1.4.b. If multiple lot coverage is desired under one permit, it may be obtained under the General Permit for Discharges from UPDES Permit No. UTRC00000. Multiple lots may be covered under one tracking number (one permit coverage) provided that UTRC00000 is the controlling permit, and all lots covered under that tracking number are within the same sub-division.

1.2. Discharges Allowed. This permit allows discharges of storm water from construction activity at a project site, provided the storm water discharge meets the requirements within this permit.

1.3. Non-Storm Water Discharges. Other non-storm water discharges that are allowed are:

1.3.1. Flushings from potable or irrigation water sources where they have not been used for a washing or cleaning activity;

1.3.2. Water used for dust control;

1.3.3. Spring water and groundwater that have not been soiled with sediment or other pollutants from construction activity;

1.3.4. Emergency fire-fighting activities, and;

1.3.5. Footing drains that have not been soiled from construction activity.

1.4. How to Obtain Permit Coverage. The permit may be obtained online at the Utah Department of Environmental Quality (DEQ) UPDES Permits website at

<http://www.waterquality.utah.gov/UPDES/stormwatercon.htm>. Click on "Application for a Storm Water Permit". Create an account, or if an account has already been created, proceed with providing the information requested. **The notice of intent (NOI) for this permit is the same NOI that is used for the UTRC00000 permit.** To complete the application process the permittee must pay a permit fee. The NOI may be filled out electronically using the online permit application system. The NOI can also be submitted using a paper form obtained from the same website cited above along with the permit fee. The paper form and fee can either be hand delivered to Utah Division of Water Quality [DWQ], 195 North 1950 West, Salt Lake City, Utah, 3rd floor in the MASOB building, or mailed to DWQ, P.O. Box 144870, Salt Lake City, Utah 84114-4870. When a party receives coverage under the permit, they will receive a permit

General Storm Water Permit for Construction Activity Connected with Single Lot Housing Projects
UPDES Permit No. UTRH00000

tracking number and the opportunity to copy the NOI for “proof of coverage.” A copy of this permit may be downloaded from the DEQ website at <http://www.deq.utah.gov/Permits/water/updes/stormwatercon.htm>.

- 1.5. Signature on the NOI. The owner and the general contractor, which in some cases could be the same party, must sign the paper copy of the NOI (see 5.16.1.a) and place it in the storm water pollution prevention plan (SWPPP) (see 4.2.8).
- 1.6. Permit Renewal. This permit must be renewed yearly on the anniversary date of the original permit application. This is done by logging onto the account created at the time of NOI application, refreshing the information on the NOI, and paying the yearly permit fee.
- 1.7. Start and end of Permit Coverage. Permit coverage begins immediately upon completion and submission of an NOI and the permit fee. If the NOI is submitted electronically on-line permit coverage begins on that day. If the NOI is submitted by mail permit coverage begins when the NOI is received and entered into the on-line data base by DWQ staff. For projects within the jurisdiction of a regulated MS4 (see definitions in Part 6; the list of regulated MS4’s is found on <http://www.deq.utah.gov/Permits/water/updes/stormwatermun.htm>), the permittee must also notify and receive approval for the project from the regulated MS4 having jurisdiction before the project may commence (see 4.2.10.). The permit fee is an annual fee that must be paid yearly on the anniversary date of permit issuance. The permit will remain effective until or unless any of the following occurs:
 - 1.7.1. The permittee completes the notice of termination (NOT) process, as outlined in section 1.8,
 - 1.7.2. The permittee fails to submit the yearly permit fee,
 - 1.7.3. Aside from permit coverage, which may be renewed annually by the permittee, as needed, this general permit expires every 5 years and normally is renewed through a public notice process by DWQ. In the event that the permit nears the end of its 5 year cycle, and the year of permit coverage for a construction site extends beyond the expiration date for the permit, the permittee must request continuing coverage through the permit renewal process. Otherwise permit coverage for a construction site will terminate when the general permit expires. Renewal of permit coverage can be done in the online electronic storm water data base up to 12 months prior to the expiration of the permit, or by letter received by DWQ before the expiration date of the specific permit coverage in question where concurrently all entries in the NOI can be updated as needed.
 - 1.7.3.a. If a renewal permit has been issued and is in place at the expiration date of this permit, this permit will terminate and coverage under the renewed permit will begin on the expiration date unless 1.7.1 has been invoked by the permittee.
 - 1.7.3.b. If a renewal permit has not been issued, this permit will be administratively extended until a renewal permit is issued or it is determined that this permit will not be continued. If a renewal permit is issued, and the permittee indicated a desire for continuing coverage under the new permit, coverage

General Storm Water Permit for Construction Activity Connected with Single Lot Housing Projects
UPDES Permit No. UTRH00000

will continue for the permittee under the new permit coverage unless 1.7.1 is invoked. If the permit is discontinued, the permittee must continue coverage under another general permit or an individual permit.

- 1.7.4. Coverage under this permit is rescinded or revoked for administrative reasons. In this case, the permittee will be notified in writing from the Director and will be required to apply for coverage under a different general or individual UPDES permit. This permit is terminated on the day coverage under another permit begins.
- 1.8. Notice of Termination. The permittee must terminate the permit by submitting an NOT when the project is completed. The NOT must be filed and retained for 3 years after the permit has been terminated (see 3.7). To terminate the permit, the permittee must comply with either 1.8.1 or 1.8.2, outlined below, and must comply with 1.8.3 if the project is within the jurisdiction of a regulated MS4 (see <http://www.deq.utah.gov/Permits/water/updes/stormwatermun.htm> for regulated MS4s):
- 1.8.1. The landscaping is completed and the site meets “final stabilization” requirements (see part 6, definitions, for final stabilization).
- 1.8.2. When a project (residential building) is completed but ‘final stabilization’ is not established, the building must be in process of being sold and ready for homeowners to take possession. If built by the homeowners, they must be in the process of moving in or already have moved in the house. The lot must have perimeter controls on downslope boundaries and surface stabilization controls on all surfaces that are 20 % (1 to 5 slope, or 11.3 degrees) or greater to prevent erosion and soil migration offsite;
- 1.8.3. The permittee must submit a paper copy of a NOT form to the MS4 of jurisdiction and schedule a final inspection (with the MS4). Termination is complete upon approval of the final inspection from the local MS4, or from DWQ if outside the jurisdiction of a regulated MS4.
- 1.9. Water Quality: Through the design of appropriate BMPs, it is expected that the permittee will achieve compliance with water-quality standards. If additional information becomes available indicating a project site is causing or is contributing to a violation of water quality standards or an existing total maximum daily load (TMDL), coverage under this permit may be revoked or rescinded, and the permittee may be required to get coverage under an individual UPDES permit or another UPDES general permit. If this occurs, the owner and the general contractor will be notified in writing by the Director and given instructions on how they must proceed.
- 1.10. Requirement to Post a Notice of Permit Coverage. The permittee must post a sign at the project site that includes the UPDES Permit tracking number, owner or general contractor contact name, a phone number for the owner or general contractor, an email address for the owner or general contractor, and in the case of an electronic SWPPP, a web address or information on how to access the electronic SWPPP. The notice must be posted with lettering large enough to be readable from a public right-of-way.

2. POLLUTION PREVENTION REQUIREMENTS

2.1. Structural Controls. Minimize sediment transport off the site as follows:

- 2.1.1. *Stockpiled Material*. Stockpiled material must not be stored on an impervious surface, except a material that will not be transported with precipitation, such as two-inch graded and washed gravel, unless it will be permanently placed and the holding area will be swept clean the same day it is dropped. If stored temporarily for more than a day, it must be placed as far as feasibly possible from roads or other impervious surfaces, storm water inlets, or water bodies, and with stockpile perimeter runoff controls utilized.
- 2.1.2. *Perimeter Controls*. Perimeter controls such as silt fences, straw wattles, other filter berms, cut back curbs, vegetative buffers, etc., must be properly placed on the downslope sides of the project to prevent sediment from leaving the site during a storm event. As perimeter controls become loaded to 1/3 of capacity, they must be cleaned.
- 2.1.3. *Inlet Protection*. Storm-drain inlets on the project site and on adjacent roads immediately down gradient from the site must be protected if they receive drainage from the active construction site. Protection may be, but is not limited to, rock wattles, sand bags, proprietary devices, or other. Rock wattles and sand bags are not advised for use in winter because they can be destroyed or removed by snow plows.

2.2. Protection of Critical or Sensitive Areas: Critical or sensitive areas such as preservation of the drip line around trees, wetlands, buffer zones by water bodies, etc., must be separated and isolated by clearly marking the areas with environmental fencing.

2.3. Managing the Site to Minimize Sediment Transport Offsite.

- 2.3.1. The total area of soil disturbance at any one time must be minimized by disturbing only the area necessary to complete that stage of construction in the construction process.
- 2.3.2. Soil disturbances on steep slopes must be minimized. For purposes of this permit a steep slope is 70% (or 1 to 1.66, or 35 degrees), or greater. This means avoiding a disturbance of soils on steep slopes or if disturbing the soil surface is necessary providing a robust surface stabilizing cover (such as geomats, environmental blankets, or other robust slope stabilizing control) to prevent erosion.
- 2.3.3. Storm water volume and velocity must be controlled to minimize soil erosion and sediment transport by methods such as allowing or not obstructing infiltration and using velocity-control devices to reduce energy in runoff flowing on slopes.
- 2.3.4. Storm water discharges leaving the site, including both peak flowrates and total storm water volume, must be controlled to minimize channel and stream-bank erosion and scour in the immediate vicinity of discharge points. This may be accomplished using experience, estimates, and good judgement; unless unusual or extraordinary site conditions present a potential for excessive erosion, hillside/impoundment collapse, environmental/safety hazards, or other site problems; for which a professional engineer must be consulted.

2.3.5. *Thirty-Foot Vegetative Buffer.* If a waterbody is adjacent to, within 30 feet from, or passing through the project boundaries, a 30-foot natural buffer between the waterbody and construction activity must be provided. If a 30-foot natural buffer cannot be provided, a substitute control measure equivalent to the 30-foot buffer must be provided, or the SWPPP must contain an explanation why neither is feasible. If it is not feasible to maintain a 30-foot natural buffer, as much natural buffer as is possible must be preserved and coupled with placement of additional erosion and sediment controls designed, implemented, and maintained to substitute and be equivalent to the 30-foot natural buffer.

The requirement for a natural buffer or substitute controls does not apply to any area outside of the project boundaries, but if a waterbody is within, for example, 20 feet from the project boundary, there must be 10 feet of natural vegetative buffer or substitute controls, or if within 25 feet from the project boundary, there must be 5 feet of natural vegetative buffer or substitute controls, and so forth.

2.3.5.a. Substitution for a natural buffer should be calculated with models such as USDA's RUSLE2 or WEPP, or by using SEDCAD, SEDIMOT, or other similar models. In lieu of using a model for calculation of a substitution buffer, the permittee shall deploy the following:

2.3.5.a.i. For every full 9 feet of natural buffer that is not provided on slopes up to 10 percent, one row of an effective perimeter control, such as a silt fence, staked straw wattle, proprietary or other filter berm, or other perimeter control, must be properly placed. For example, if only 15 feet of natural buffer can be provided, the permittee will substitute one row of a perimeter control in addition to the 15 feet of natural buffer to make up for the 15 feet of buffer that could not be preserved.

2.3.5.a.ii. In addition to the requirements above for substitutions in place of the 30-foot natural buffer, on slopes between 10 percent and 30 percent, five feet of surface stabilization must be placed down gradient of and between each perimeter control substituted. For slopes steeper than 30 percent, 6 feet of surface stabilization must be placed downgradient of and between each perimeter control substituted, such as mulch, hydromulch, wood chips, bark, compost, erosion mat, etc., but excluding tackifiers.

2.4. Good Housekeeping Measures. The permittee must address the following:

2.4.1. *Track Out.* Track-out pads (see definitions) and or rumble strips (see definitions) must be used to prevent dirt/mud tracked on streets as vehicles leave the site. If traffic onto and off the site is not frequent, a site operator may impose a blanket prohibition of vehicle traffic onto the site, allowing for the occasions to deliver and unload, but afterwards providing sweeping and/or cleaning of tracked out dirt (keep in mind that vehicles leaving a muddy site with no track out protection can track mud for several

- blocks – the operator is liable for all track out from the site except for a dirt stain after sweeping -- see note after 3.2.2.). Dirt or mud tracked out on the street must not be washed or hosed into a storm drain. Tracked out mud or dirt on the street must be swept and/or scraped up as needed every day (see 3.2.2).
- 2.4.2. *Curb Ramps*: This permit prohibits the intentional placement of dirt and/or mud on paved streets or sidewalks. Curb ramps may be crushed rock, wood or steel ramps, or another material that does not wash away with storm water.
- 2.4.3. *Waste and Debris*. The site must be cleaned of waste and debris daily (see daily self-inspection 3.2.2). Waste and debris must be contained and secured adequately to prevent scattering from wind until it is removed from the site and disposed of properly.
- 2.4.4. *Portable Toilet*. Portable toilets must be tied down, staked down, or secured using other measures to prevent turn over, and they must be placed away from a road gutter, storm water inlet, or waterbody.
- 2.4.5. *Washing of Concrete, Stucco, and Paint Equipment*. A plastic film-lined pit or sealed container must be provided for washout of equipment used for concrete, stucco, and water-based paint. After completion of concrete, stucco, and paint tasks, the permittee must dispose of the waste by drying and sending solids to a landfill. Oil-based paint cleanout must be done in containers, taken off-site, and disposed of separately.
- 2.5. Soil Compaction/Top Soil. Topsoil must be preserved and placed on areas to be landscaped or areas planned for receiving vegetative cover, unless infeasible. Soil compaction must be minimized on areas that will not be used for support of structural elements such as roads, parking areas, structures, etc., unless infeasible.
- 2.6. Stabilization Requirement. Stabilization requirements are as follows:
- 2.6.1. *Stabilization requirements for areas that receive 20 inches of rainfall annually or greater*: Stabilization of disturbed areas must, at a minimum, be initiated immediately whenever any clearing, grading, excavating or other earth disturbing activities have permanently ceased on any portion of the site or have temporarily ceased on any portion of the site for greater than 14 calendar days. Stabilization can be sodding, planting, application of mulch (wood chips, rock, gravel, bark, compost, cat tracking on straw, hydromulch, etc.), application of geotextiles or erosion blankets, application of a tackifier, seeding (including preparation for germination and growth), a combination of these methods, or other method.
- 2.6.2. *Stabilization or equivalent requirements for arid and semi-arid areas (areas receiving less than 20 inches of rainfall annually)*: Stabilization for visually flat areas is not required (roughly up to 5 percent, 1 to 20 slope, or 2.3 degrees slope). Areas with slopes up to roughly 20 percent (1 to 5 slope or 11.3 degrees) must have, at minimum, velocity-control devices in every area where storm water collects and flows, spaced close enough across the flow to stop erosion (see also 2.3.3). Soil surface stabilization such as sodding, planting, hydromulch, compost, bark, cat tracking on straw, gravel,

geotextiles, erosion blankets, or other stabilization methods is required on all other sloped areas, increasing the robust nature of stabilizing cover commensurately with increasingly steeper slopes.

2.6.3. *Permanent Stabilization for Arid areas.*

2.6.3.a. In addition to requirements above (see 2.6.2), permanent stabilization requires seeding on all areas that are not covered with permanent stabilization elements or structural elements such as building structure or pavement, or that are engineered or intended for structural purposes like graveled parking or dirt roads.

2.6.3.b. Disturbed areas on projects located outside of populated and developed areas and where no irrigation water is available and where future periodic landscaping maintenance is not planned must be reclaimed with a seed mix of plants indigenous to the area or tolerant to the local climatic conditions that does not include invasive species. Velocity-control devices may be permanent or temporary. If velocity-control devices are intended for temporary use, they must be biodegradable and designed durable enough to withstand extreme weather.

2.7. Construction Dewatering. Construction dewatering can occur onsite without an additional UPDES permit if it is infiltrated or contained onsite and is not discharged offsite. Otherwise, construction dewatering discharges must be permitted under the General Permit for Construction Dewatering and Hydrostatic Testing UPDES Permit UTG070000, which can be obtained online through submittal of an NOI at <https://secure.utah.gov/waterquality>.

2.8. Pollution Prevention Measures. The permittee must design, install, implement, and maintain effective pollution prevention measures to minimize the discharge of pollutants. At a minimum, such measures must address the following:

2.8.1. *Vehicle, Wheel, and Other Washing.* Minimize the discharge of pollutants from equipment and vehicle washing, wheel-wash water, and other wash waters. Wash waters must be treated in a sediment basin or alternative control that provides equivalent or better treatment prior to discharge

2.8.2. *Exposure to Pollutants.* Minimize the exposure of building materials, building products, construction wastes, trash (see 2.4.3), landscape materials, fertilizers, pesticides, herbicides, detergents, sanitary waste (see 2.4.4), and other materials present on the site to precipitation and to storm water. Minimization of exposure is not required in cases where the exposure to precipitation and to storm water will not result in a discharge of pollutants, or where exposure of a specific material or product poses little risk of storm water contamination (e.g., final products and materials intended for outdoor use).

2.8.3. *Leaks and Spills.* Minimize the discharge of pollutants from spills and leaks and implement chemical spill and leak prevention and response procedures.

2.9. Prohibited Discharges. The following discharges are prohibited:

2.9.1. Wastewater from washout or cutting of concrete (see 2.4.5),

General Storm Water Permit for Construction Activity Connected with Single Lot Housing Projects
UPDES Permit No. UTRH00000

- 2.9.2. Wastewater from washout and cleanout of stucco, paint, form release oils, curing compounds, and other construction materials (see 2.4.5),
- 2.9.3. Fuels, oils, or other pollutants used in vehicle and equipment operation and maintenance,
- 2.9.4. Soaps or solvents used in vehicle and equipment washing.

3. SELF-INSPECTION REQUIREMENTS.

3.1. Inspector Qualifications. Weekly inspections (see 3.2.1 below) must be done by a qualified person. A qualified person means a person knowledgeable in the principles and practices of erosion and sediment control that possesses the skills to:

- 3.1.1. Assess conditions at the construction site that could impact storm water quality,
- 3.1.2. Assess the effectiveness of a storm water control measure selected to control the quality of storm water discharges from the construction activity.

3.2. Self-Inspections.

- 3.2.1. *Weekly Self Inspections:* Self-inspections must occur every 7 days. A written report is required (see 3.4).
- 3.2.2. *Daily Site Check:* Each day of construction activity, the site must be inspected for dirt in the street and trash on the site. Streets must be swept clean (see note below), if soiled. Dirt must be removed off the street (not swept or washed into the storm drain system). Trash on the site must be picked up and disposed of into trash containers (see 2.4.3.) or disposed of off-site (e.g., municipal/private garbage collection service or construction waste landfill). Sub-contractors must be held responsible by the permit holder to perform these duties in accordance with this paragraph for the activities they are contracted to perform. A written report is not required, however the operator will keep a daily log (for the active construction days) listing the initials of the person doing the site check.

Note: Swept clean means sweeping and scraping. Scraping if there is dirt left behind that is crusted and that sweeping will not pick up. This does not mean removing the microscopic layer of dust or the minute amounts of dirt in the cracks and crevices of the surface left behind staining the pavement.

3.3. Weekly Self-Inspection Requirements.

- 3.3.1. *Areas to check include the following:*
 - 3.3.1.a. Areas that have been cleared, graded, or excavated that are not stabilized,
 - 3.3.1.b. All storm water control measures, including perimeter controls,
 - 3.3.1.c. Material piles, waste-disposal containers, sanitary facilities, loose trash, litter, washout areas, portable toilets, track out pad, egress points (if any), etc.,
 - 3.3.1.d. Storm water conveyances through the site, treatment areas, and drainages,
 - 3.3.1.e. All storm water discharge points, street gutters, storm water inlets,
 - 3.3.1.f. Areas that have been temporarily stabilized,
 - 3.3.1.g. Areas that have been permanently stabilized and are completed do not need further inspections.
- 3.3.2. *Items to check include the following:*
 - 3.3.2.a. All erosion and sediment controls and other pollution prevention controls

General Storm Water Permit for Construction Activity Connected with Single Lot Housing Projects
UPDES Permit No. UTRH00000

have been installed, are operational, and are working as intended to minimize pollutant discharges. Determine if any controls need to be replaced, repaired, or maintained.

3.3.2.b. Identify any locations where new or modified storm water controls are necessary.

3.3.2.c. Signs of visible erosion and sedimentation (i.e., sediment deposits) that have occurred and are attributable to discharges from your site,

3.4. Weekly Inspection Reports. The weekly self-inspection report must be written within 24 hours of inspection and must include:

3.4.1. The initials of the person doing the inspection,

3.4.2. The date of the inspection,

3.4.3. The weather during the inspection,

3.4.4. The problems that were found needing correction (as they pertain to 3.3.1 and 3.3.2 above),

3.4.5. The date when corrective action is completed,

3.4.6. All self-inspection reports must be filed with other permit records regarding the permit. Inspection reports must be available during an oversight inspection.

3.5. Corrective Action: Corrective action must be completed before the next weekly inspection.

3.6. Inspections by an Oversight Authority. A copy of an oversight inspection report must be filed and be available for review during other oversight inspections.

3.7. Record Keeping. Records regarding this permit, the NOI, the NOT, the SWPPP, inspection reports, other related information and documents must be preserved for 3 years after the submission of the NOT (see 5.10).

4. STORM WATER POLLUTION PREVENTION PLAN (SWPPP).

4.1. SWPPP Requirement. The permittee must prepare a SWPPP before the NOI for the project is submitted. The SWPPP must address all the applicable requirements in Part 2.

4.1.1. *SWPPP Site Design*. The design, installation, and maintenance of erosion and sediment controls must address factors such as the amount, frequency, intensity and duration of precipitation; the nature of resulting storm water runoff; and soil characteristics, including the range of soil particle sizes expected to be present onsite. These may be accomplished using experience, estimates, and good judgement, unless unusual or extraordinary site conditions create hazards for which a professional engineer must be consulted.

4.1.2. *Surface Outlets*: When discharging from basins and impoundments, utilize outlet structures that withdraw water from the surface, unless infeasible.

4.2. Contents of a SWPPP. A SWPPP must contain the following:

4.2.1. *Contacts*. The contacts for the site with contact information (name, address, telephone, email) including owner, general contractor, and any other party that significantly affects the implementation of the SWPPP or has responsibilities over the SWPPP.

4.2.2. *Sequence and Estimated Dates of Construction Activities*. Listed in the sequence with estimated dates including the following:

4.2.2.a. Start and end of excavation activities, initial excavation, backfill excavation and final grading,

4.2.2.b. Any temporary or permanent cessation of earth-disturbing activities,

4.2.2.c. Start and end of landscaping if this is done as part of the construction activity before the home is sold.

4.2.3. *Site Map or Chart*. A site map may be hand drawn (as close to scale as possible) or may be a copy of an architect drawing including the following information:

4.2.3.a. Boundaries of the property,

4.2.3.b. Boundaries of soil surface disturbances, including any outside the boundaries of the property,

4.2.3.c. Slopes, including areas of steep slopes,

4.2.3.d. Locations of stockpiles of soils, storage of construction materials, portable toilets, trash containers, concrete washout pits or containers, egress points, and track out pads,

4.2.3.e. Waterbodies, wetlands, and natural buffer areas,

4.2.3.f. Locations and types of BMPs or storm water control measures for the control and/or treatment of storm water flowing onto, through, and/or offsite,

4.2.3.g. Locations of storm water inlets, storm water discharge points going off site,

General Storm Water Permit for Construction Activity Connected with Single Lot Housing Projects
UPDES Permit No. UTRH00000

- 4.2.3.h. Areas that will be temporarily or permanently stabilized during the construction period.
- 4.2.4. *Thirty-Foot Natural Buffer.* The SWPPP must show the dimensions and placement of the 30-foot natural buffer, the substitute control measures, or a detailed explanation of why a natural buffer or substitute control measure could not be applied.
- 4.2.5. *Pollutants.* A list of construction site pollutants including the pollutant-generating activity, and an inventory of pollutants for each pollutant generating activity (e.g., paints, solvents, form oil, fuels, and other chemicals; applications, materials, and liquids that if released could pollute storm water).
- 4.2.6. *Waste Management.* Waste management procedures including soil removal, clearing debris removal, demolition removal, trash disposal, construction-waste disposal, and sanitary-waste disposal.
- 4.2.7. *Training.* The permittee will ensure that each subcontractor or utility provider is aware of their responsibilities for keeping soil on the site and preventing pollution. The permittee must keep in mind that they are responsible for and may be issued fines for poor performances by their subcontractors and utility providers. Consideration will be given if the permittee can document when and what instructions were given to the subordinate party.
- 4.2.8. *NOI and Permit.* The SWPPP must contain a copy of this permit and a copy of the NOI for the project.
- 4.2.9. *SWPPP Signature and Certification.* The SWPPP must be signed and certified by both the Owner and the General Contractor in accordance with 5.16.1.a.
- 4.2.10. *MS4 Approval of Project.* For areas where projects are within a regulated MS4's jurisdiction (see definitions in Part 6; the list of regulated MS4's is found on <http://www.deq.utah.gov/Permits/water/updes/stormwatermun.htm>), the SWPPP must contain the signature and date of the MS4 reviewer who has approved the proposed project for construction (see 1.7.).
- 4.2.11. *Availability of the SWPPP.* The SWPPP must be available at the construction site covered under this permit during onsite construction activity, unless the SWPPP is available online. If the SWPPP is available online there must be a sign (see 1.10) that describes where the SWPPP can be accessed online. The SWPPP is a plan for the site, and workers must be able to refer to the SWPPP and update it as needed to manage the site (including SWPPPs found on the internet). The SWPPP is not required to be on the site when construction workers leave for the day or when there is no activity occurring on the site, but at all times there must be posted contact information where the SWPPP can be obtained (see Part 1.10). The SWPPP must be made available within 24 hours to DWQ representatives or other oversight inspectors, e.g., U.S. Environmental Protection Agency [EPA] or a local MS4, on request, or immediately during an inspection on the site when there are workers and activity at the site.

General Storm Water Permit for Construction Activity Connected with Single Lot Housing Projects
UPDES Permit No. UTRH00000

- 4.2.12. *Required Modifications of the SWPPP.* The SWPPP must be modified as follows:
- 4.2.12.a. During inspections when it is determined from observations of site conditions that storm water control measures are:
 - 4.2.12.a.i. Not adequate or not shown in the SWPPP, or
 - 4.2.12.a.ii. Changes in the SWPPP are necessary for compliance with this permit.
 - 4.2.12.b. When an oversight authority determines that the SWPPP is not adequate based on missing a required SWPPP or permit item, not addressing pollutants properly, not being up to date and reflecting current site conditions, or not being clear, thorough, and understandable.
- 4.2.13. *SWPPP Modifications Deadline.* Modifications to the SWPPP from inspections or oversight authority direction must occur before or during the next weekly inspection.

5. STANDARD PERMIT CONDITIONS.

5.1. Duty to Comply.

5.1.1. The permittee must comply with all conditions of this permit. Any permit noncompliance constitutes a violation of the Utah Water Quality Act (the Act) and is grounds for enforcement action; for permit termination, revocation and reissuance, or modification; or for denial of a permit renewal application.

5.1.2. *Penalties for Violations of Permit Conditions*

5.1.2.a. *Violations.* The Act provides that any person who violates the Act, Utah wastewater or storm water rules, or conditions of a permit issued under the Act, is subject to a fine of \$10,000 per day.

5.1.2.b. *Willful or Gross Negligence.* The Act provides that any person who discharges a pollutant to waters of the State as a result of criminal negligence or who intentionally discharges is criminally liable and is subject to imprisonment and a fine of up to \$50,000 per day (Utah Code Annotated 19-5-115).

5.1.2.c. *False Statements.* The Act provides that any person who knowingly makes any false material statement, representation, or certification in any application, record, report, plan, or other document filed or required to be maintained under the Act, the rules, or this permit, or who knowingly falsifies, tampers with, or renders inaccurate, any monitoring device or method required to be maintained under the Act shall upon conviction, be punished by a fine of not more than \$10,000 or by imprisonment for 6 months, or by both (Utah Code Annotated 19-5-115(4)).

5.2. Duty to Reapply. If a permittee wishes to continue an activity regulated by this permit after the expiration date of this permit, the permittee must apply for and obtain a new permit except as provided in 1.6 and 1.7 of this permit.

5.3. Need to Halt or Reduce Activity not a Defense. It shall not be a defense for a permittee in an enforcement action that it would have been necessary to halt or reduce the permitted activity in order to maintain compliance with the conditions of this permit.

5.4. Duty to Mitigate. The permittee shall take all reasonable steps to minimize or prevent any discharge in violation of this permit that has a reasonable likelihood of adversely affecting human health or the environment.

5.5. Duty to Provide Information. The permittee shall furnish to the Director or an authorized representative, within a reasonable time, any information that is requested to determine compliance with this permit. The permittee must also furnish to the Director or an authorized representative copies of records to be kept by this permit.

5.6. Other Information. When the permittee becomes aware that he or she failed to submit any relevant facts or submitted incorrect information in the NOI or in any other report to the Director, he or she shall promptly submit such facts or information.

General Storm Water Permit for Construction Activity Connected with Single Lot Housing Projects
UPDES Permit No. UTRH00000

- 5.7. Oil and Hazardous Substance Liability. Nothing in this permit shall be construed to preclude the institution of any legal action or relieve the permittee from any responsibilities, liabilities, or penalties to which the permittee is or may be subject under the Act.
- 5.8. Property Rights. The issuance of this permit does not convey any property rights of any sort, nor any exclusive privileges, nor does it authorize any injury to private property nor any invasion of personal rights, nor any infringement of Federal, State or local laws or regulations.
- 5.9. Severability. The provisions of this permit are severable, and if any provision of this permit, or the application of any provision of this permit to any circumstance, is held invalid, the application of such provision to other circumstances, and the remainder of this permit shall not be affected thereby.
- 5.10. Record Retention. The permittee shall retain copies of SWPPPs and all reports required by this permit, and records of all data used to complete the NOI to be covered by this permit, for a period of at least three years from the date that the permit for the site is terminated (see 3.7). This period may be extended by request of the Director at any time.
- 5.11. Addresses. All written correspondence under this permit shall be directed to the DWQ at the following address:
- Department of Environmental Quality
Division of Water Quality
195 North 1950 West
P.O. Box 144870
Salt Lake City, Utah 84114-4870
- 5.12. State Laws. Nothing in this permit shall be construed to preclude the institution of any legal action or relieve the permittee from any responsibilities, liabilities, or penalties established pursuant to any applicable State law or regulation under authority preserved by Utah Code Annotated 19-5-117.
- 5.12.1. No condition of this permit shall release the permittee from any responsibility or requirements under other environmental statutes or regulations.
- 5.13. Proper Operation and Maintenance. The permittee shall at all times properly operate and maintain all facilities and systems of treatment and control and related appurtenances which are installed or used by the permittee to achieve compliance with the conditions of this permit and with the requirements of SWPPPs. Proper operation and maintenance also includes adequate laboratory controls and appropriate quality assurance procedures. Proper operation and maintenance requires the operation of backup or auxiliary facilities or similar systems, installed by a permittee only when necessary to achieve compliance with the condition of the permit.
- 5.14. Inspection and Entry. The permittee shall allow, upon presentation of credentials, the Director or an authorized representative to:
- 5.14.1. Enter upon the permittee's premises where a regulated facility or activity is located or conducted or where records must be kept under the conditions of this permit;

General Storm Water Permit for Construction Activity Connected with Single Lot Housing Projects
UPDES Permit No. UTRH00000

- 5.14.2. Have access to and copy at reasonable times, any records that must be kept under the conditions of this permit.
- 5.14.3. Inspect at reasonable times any facilities, equipment (including monitoring and control equipment), practices or operations regulated or required under this permit; and
- 5.14.4. Sample or monitor at reasonable times for the purposes of assuring permit compliance or as otherwise authorized by law, any substances or parameters at any location.

5.15. Reopener Clause.

- 5.15.1. *Reopener Due to Water Quality Impacts.* If there is evidence indicating that the storm water discharges authorized by this permit cause, have the reasonable potential to cause, or contribute to a violation of a water-quality standard, the discharger may be required to obtain an individual permit or an alternative general permit in accordance with 1.7.4 of this permit or the permit may be modified to include different limitations and/or requirements.
- 5.15.2. *Reopener Guidelines.* Permit modification or revocation will be conducted according to Utah Administrative Code R317-8-5.6 and UAC R317-8-6.2.
- 5.15.3. *Permit Actions.* This permit may be modified, revoked and reissued, or terminated for cause. The filing of a request by the permittee for a permit modification revocation and reissuance, termination, a modification of planned changes or anticipated noncompliance does not stay any permit condition.

5.16. Signatory Requirements.

- 5.16.1. All NOIs, SWPPPs, reports, certifications or information submitted to the Director, or that this permit requires be maintained by the permittee, shall be signed as follows:
 - 5.16.1.a. All NOIs and SWPPPs shall be signed by both the owner or lessee of the project/property and the general contractor.
 - 5.16.1.b. All reports required by the permit and other information requested by the Director or by an authorized representative of the Director shall be signed by a person described above or by a duly authorized representative of that person. A person is a duly authorized representative only if:
 - 5.16.1.b.i. The authorization is made in writing by a person described above and submitted to the Director; and
 - 5.16.1.b.ii. The authorization specifies either an individual or a position having such as the position of manager, operator, superintendent, or position of equivalent responsibility or an individual or position having overall responsibility for environmental matters for the company. A duly authorized representative may therefore be either a named individual or any individual occupying a named position.
 - 5.16.1.c. *Certification.* Any person signing documents under 5.16 shall make the following certification:

General Storm Water Permit for Construction Activity Connected with Single Lot Housing Projects
UPDES Permit No. UTRH00000

I certify under penalty of law that this document and all attachments were prepared under my direction or supervision in accordance with a system designed to assure that qualified personnel properly gathered and evaluated the information submitted. Based on my inquiry of the person or persons who manage the system, or those persons directly responsible for gathering the information, the information submitted is, to the best of my knowledge and belief, true, accurate, and complete. I am aware that there are significant penalties for submitting false information including the possibility of fine and imprisonment for knowing violations.

- 5.16.2. If a document is to be signed electronically, the Division's rules regarding electronic transactions govern, if applicable.

6. DEFINITIONS

Arid Areas: Areas with an average annual rainfall of 10 inches or less.

Common Plan of Development (or sale): A plan to subdivide a parcel of land into separate parts for separate sale. This can be for a residential, commercial, or industrial development. The plan originates as a single parcel that is separated into parts. This usually goes through an approval process by a local governmental unit, but in some cases, it may not require that process. The original plan is considered the "common plan of development or sale" whether phased or completed in steps.

Additional information related to *Common Plan of Development for Permit Purposes:*

For UPDES storm water permit purposes, a common plan must have been initiated after October, 1992. A common plan of development or sale remains so until each lot or section of the development has fulfilled its planned purposes (e.g. in a residential development as homes are completed, stabilized, and sold or occupied). As lots or separated sections of the development are completed, the lot or section is stabilized, and the plan purposes are fulfilled for that area, lot, or section, it is no longer part of the common plan of development or sale (e.g. if a home is sold in a development and the owner decides to add a garage somewhere on the lot, that garage project is not part of the common plan of development or sale.

In this process a common plan of development or sale may become reduced in size and/or separated by completed areas which are no longer part of the common plan of development or sale, but all unfinished lots remain part of the same common plan development or sale until they are completed, stabilized, and fulfilled according to the purposes of the plan.

Construction Activity: Earth-disturbing activities, such as the clearing, grading, and excavation of land.

Construction Waste: Discarded material such as packaging materials, scrap construction materials, masonry products, timber, steel, pipe, and electrical cuttings, plastics, and Styrofoam.

Corrective Action: For the purposes of the permit, any action taken to 1) repair, modify, or replace any storm water control used at the site; 2) clean up and dispose of spills, releases, or other deposits found on the site; and 3) remedy a permit violation.

Dewatering: The act of draining rainwater and/or groundwater from building foundations, vaults, and trenches (Note: if dewatering is occurring on a construction site and it causes a discharge to waters of the State, it must be permitted separately under the General Permit for Construction Dewatering and Hydrostatic Testing , UPDES Permit UTG070000).

Director: The director of the Division of Water Quality.

Discharge Point: For the purposes of this permit, the location where collected and concentrated storm water flows are discharged from the construction site.

Final Stabilization: All disturbed areas must be covered by permanent structures such as pavement, concrete slab, building, etc., or for areas not covered by permanent structures but that are receiving 20 inches or more of average annual precipitation, vegetation has been established with a uniform (e.g.,

General Storm Water Permit for Construction Activity Connected with Single Lot Housing Projects
UPDES Permit No. UTRH00000

evenly distributed, without large bare areas) perennial vegetative cover equivalent to 70 percent of the natural background vegetative cover. In the case of areas that are not covered by permanent structures, but that are receiving less than 20 inches of average annual precipitation (arid areas, 0-10 inches; semi-arid areas, 10-20 inches), final stabilization is equivalent to the requirements of 2.6.3 of this permit, including the provisions for permanent stabilization.

Impervious Surface: For the purpose of this permit, any land surface with a low or no capacity for water infiltration including, but not limited to, pavement, sidewalks, parking areas, driveways, or rooftops.

Indian Country: Defined at 40 CFR §122.2 as follows:

1. All land within the limits of any Indian reservation under the jurisdiction of the United States Government, notwithstanding the issuance of any patent, and, including rights-of-way running through the reservation;
2. All dependent Indian communities within the borders of the United States whether within the originally or subsequently acquired territory thereof; and
3. All Indian allotments, the Indian titles to which have not been extinguished, including rights-of-ways running through the same.

Infeasible: Infeasible means not technologically possible or not economically practicable and achievable in light of best industry practices. DWQ notes that it is not intentional for permit storm water control efforts required in the permit to conflict with State water rights law. In the case of conflict, State water rights law supersedes.

Install or Installation: When used in connection with storm water controls, to connect or set in position storm water controls to make them operational.

Municipal Separate Storm Sewer System or MS4: A storm-sewer system owned and operated by a state, city, town, county, district, association, or other public body created by or pursuant to State law having jurisdiction over disposal of storm water that discharges to waters of the State (e.g., Sandy City owns and operates the MS4 within the jurisdiction of Sandy City, or essentially Sandy City is the MS4).

Natural Buffer: For the purposes of this permit, an area of undisturbed natural cover surrounding surface waters within which construction activities are restricted. Natural cover includes the vegetation, exposed rock, or barren ground that exists before earth-disturbing activities begin.

Oversight Authority: Oversight authorities for storm water permits are agents from the EPA, DWQ or the Municipality of jurisdiction, when they are addressing compliance of storm water permits.

Owner: For the purpose of this permit an owner has ownership of a property on which construction activity is taking place, but it also includes ownership of a project for which construction activity is occurring on property that is leased. An owner is the party that has ultimate control over construction plans and specifications, including the ability at the highest level to make modifications to those plans and specifications. "Owner" in this context is the party that has ultimate control over the destiny of a project.

Permittee: The owner and/or the general contractor (those that signed on the NOI), for the project.

General Storm Water Permit for Construction Activity Connected with Single Lot Housing Projects
UPDES Permit No. UTRH00000

Pollutant-Generating Activities: At construction sites, for the purposes of this permit, those activities that lead to or could lead to the generation of pollutants, either as a result of earth-disturbance or a related support activity. Some of the types of pollutants that are typically found at construction sites are as follows:

- Sediment
- Nutrients
- Heavy metals
- Pesticides and herbicides
- Oil and grease
- Bacteria and viruses
- Trash, debris, and solids
- Treatment polymers
- Any other toxic chemicals

Pollution Prevention Measures: Storm water controls designed to reduce or eliminate the addition of pollutants to construction site discharges through analysis of pollutant sources, implementation of proper handling/disposal practices, employee education, and other actions.

Project Site: A project site is not necessarily contained within the property boundaries designated for the final construction objective, or property owned by the owner of the project. The project site includes all areas affected by the construction process where disturbances, storage, or other construction activity occurs. If an area outside of property boundaries is used for the construction process, DWQ assumes the permittee has the right to access and use that area and the permittee must also meet permit requirements in that area.

Receiving Water: A "Water(s) of the State" is as defined in UAC R317-1-1, into which the regulated storm water discharges (see waters of the State listed below).

Rumble Strip: A rigid ramp/track (often made of steel) that vehicles drive over that causes tires to flex and shake for the removal of dirt.

Semi-Arid Areas: Areas with an average annual rainfall of between 10 and 20 inches.

Stabilization: The use of vegetative and/or non-vegetative cover to prevent erosion and sediment loss in areas of disturbed soil exposed from the construction process.

Storm water: Means storm water runoff, snowmelt runoff, and surface runoff and drainage.

Storm Water Control Measures: Refers to any storm water control, BMP, or other method used to prevent or reduce the discharge of pollutants to waters of the state.

General Storm Water Permit for Construction Activity Connected with Single Lot Housing Projects
UPDES Permit No. UTRH00000

Storm Water Inlet: An entrance or opening to a storm water conveyance system, generally placed below grade so as to receive storm water drainage from the surrounding area.

Storm Event: A precipitation event that results in a measurable amount of precipitation.

Track Out Pad: A track out pad is a pad normally made up of 4 to 6 inches of up to 6 inch cobble rocks or gravel of various size (the size is sometimes specified by a local MS4). Sometimes it is underlain with a fabric to keep dirt and mud separated from rock or gravel. It is wide enough to underlay the tires of any/all traffic leaving a construction site as vehicles exit the site. Its function is to flex and shake the tires to dislodge mud and dirt from the tires of vehicles leaving the construction site. Track out pads must be stirred or worked periodically so that mud or dirt collected is moved to the bottom and the rock/gravel on the pad is clean and effective dislodging more mud/dirt.

Waters of the State: All streams, lakes, ponds, marshes, watercourses, waterways, wells, springs, irrigation systems, drainage systems, and all other bodies or accumulations of water, surface and underground, natural or artificial, public or private, that are contained within, flow through, or border upon this state or any portion thereof, except that bodies of water confined to and retained within the limits of private property, and that do not develop into or constitute a nuisance, or a public health hazard, or a menace to fish and wildlife, shall not be considered to be "Waters of the State" under this definition (see Utah Code Annotated, 19-5-102(23)(a) &(b), and UAC R317-1-1).

APPENDIX C: Notice of Intent and Termination.

Find the Notice of Termination Form at

<https://deg.utah.gov/Permits/water/updes/stormwatercon.htm>

However, termination of the project can be done on-line at <https://secure.utah.gov/stormwater>

(You must log in using the same username that you applied for your NOI with. If you completed a paper NOI you must complete a paper NOT.)

STATE OF UTAH, DEPARTMENT OF ENVIRONMENTAL QUALITY, DIVISION OF WATER QUALITY
195 North 1950 West, P.O. Box 144870, Salt Lake City, Utah 84114-4870 (801) 536-4300

NOI

Notice of Intent (NOI) for Storm Water Discharges Associated with Construction Activity Under the UPDES General Permit UTRH89451
SEE REVERSE FOR INSTRUCTIONS

Submission of this Notice of Intent constitutes notice that the party(s) identified in Section I of this form intends to be authorized by UPDES General Permit No. UTRH89451 issued for storm water discharges associated with construction activity in the State of Utah. Becoming a permittee obligates such discharger to comply with the terms and conditions of the permit. ALL NECESSARY INFORMATION MUST BE PROVIDED ON THIS FORM.

PERMIT PERIOD	Permit Start Date: 10/14/2018	Permit Expiration Date: 06/30/2019
PERMIT TYPE	Construction General Permit (CGP, this permit covers any construction project): <input type="checkbox"/>	
	Common Plan Permit (this only covers single lot residential construction disturbing less than an acre): <input checked="" type="checkbox"/>	
Is this NOI seeking continuation for previously expired permit coverage at the same site? Y <input checked="" type="checkbox"/> N <input type="checkbox"/>	If yes, what is the number of the previous permit coverage? Permit No. UTR	

I. OWNER INFORMATION

Owner Name: Kirt L. Bovero Phone: 801-497-1746
Address: 5018 E. Whispering Pines Lane Status of Owner: PRIVATE
City: EDEN State: UT Zip: 84310
Contact Person: Kirt L. Bovero Phone: 801-497-1746

GENERAL CONTRACTOR: Land to Sky Construction Inc. Phone: 801-497-1746
Address: 5018 E. Whispering Pines Lane Status of General Contractor: PRIVATE
City: EDEN State: UT Zip: 84310
Contact Person: Kirt L. Bovero Phone: 801-497-1746

II. FACILITY SITE / LOCATION INFORMATION

Name: Okeefe Res. Is the facility located in Indian Country? Y N
Project No. (if any):

Address: 3911 N. Zermatt County: WEBER
City: EDEN State: UT Zip: 84310
Latitude: 41.32989 Longitude: -111.81228
Method (check one): USGS Topo Map, Scale EPA Web site GPS Other

III. SITE INFORMATION

Municipal Separate Storm Sewer System (MS4) Operator Name: N/A
Receiving Water Body: Great Salt Lake known this is known this is a guess (see <http://wq.deq.utah.gov/>)
Estimate of distance to the nearest water body? 2 miles ft. miles.
Is the receiving water an impaired or high quality water body (see <http://wq.deq.utah.gov/>)? Yes No
List the Number of any other UPDES permits at the site:

IV. THIS SECTION IS ONLY FOR PROJECTS INVOLVED IN DEVELOPMENT OF A SUBDIVISION.
List the lots proposed for the development (please add another sheet of paper if there is not enough room to list all lots).

INSTRUCTIONS

Notice Of Intent (NOI) For Permit Coverage Under the UPDES General Permit For Storm Water Discharges From Construction Activities

Who Must File A Notice Of Intent (NOI) Form State law at UAC R317-8-3.9 prohibits point source discharges of storm water from construction activities to a water body(ies) of the State without a Utah Pollutant Discharge Elimination System (UPDES) permit. The owner and the general contractor of a construction activity that has such a storm water discharge must submit a NOI to obtain coverage under the UPDES Storm Water General Permit. If you have questions about whether you need a permit under the UPDES Storm Water program, or if you need information as to whether a particular program is administered by EPA or a state agency, contact the storm water coordinator at (801) 536-4300.

Where To File NOI Form The preferred method of submitting an NOI to apply for the construction general storm water permit (CGP) is electronically on-line at <http://www.waterquality.utah.gov/UPDES/stormwatercon.htm>. The fee can be submitted on line also. If on-line is not an option for you send a paper form of the NOI to the following address:

Department of Environmental Quality
Division of Water Quality
P.O. Box 144870
Salt Lake City, UT 84114-4870

Beginning of Coverage CGP coverages are issued immediately after submitting an NOI with the permit fee. The permittee should be aware that though you may not have a permit in hand, if you have submitted a completed NOI with the permit fee you are covered by the conditions in the permit and will be expected to comply with permit conditions. You can print a copy of the CGP from the DWQ web site.

Permit Fees. The permit fee is \$150.00 per year. The fee is paid by Visa/Master Card on-line when an NOI is filed (by check if submitted with a paper NOI). If the project continues for more than one year the fee must be submitted again in a renewal process on-line. CGP coverage will not be issued until the fee is paid.

Length of Coverage: CGP coverage starts the day that the NOI and fee is received at DWQ and expires a year from issuance. All CGP coverages must be renewed within 60-days after the yearly expiration date, or be terminated with a notice of termination (NOT) before the expiration date. To terminate the permit the site must meet the permit conditions for final stabilization (see permit definitions), or must continue under a different permit holder. In most cases the DWQ or municipality of jurisdiction will perform a final inspection when a CGP coverage submits an NOT. If the site passes the final inspection the permit is terminated.

The Storm Water General Permit for Construction Activities UTRC00000 will expire on June 30, 2019 – UTRH00000 expires on September 30, 2020. The Clean Water Act requires that all UPDES permits be renewed every 5 years. If a project extends beyond the expiration date of the Permit it must renew the permit and continue coverage under the renewed permit that will subsequently be developed to continue the same or similar permit coverage for construction activity.

SECTION I - FACILITY OPERATOR INFORMATION Supply the legal name(s) of the person(s), firm(s), public organization(s), or any other entity(ies) that qualifies as the owner of the project (see permit definitions). Do the same for the general contractor that conducts the construction operation at the facility or site to be permitted. The owner and the general contractor of the project may be the same.

Enter the complete address and telephone number of the owner and general contractor and a contact person and number for each. Enter the appropriate letter to indicate the legal status of the operator of the facility.

F = Federal M = Public (other than Fed or State) S = State P = Private

SECTION II - FACILITY/SITE LOCATION INFORMATION Enter the facility name or legal name and project number (if any) of the site and complete street address, including city, state and ZIP code. The latitude and longitude of the facility must be included to the approximate centroid of the site, and the method of how the Lat/Long was obtained (USGS maps, GPS, Internet Map sites [such as Google Earth], or other).

Indicate whether the facility is located in Indian Country. If the facility is located in Indian Country, do not complete this NOI, instead submit an application for coverage under a storm water permit to EPA Region VIII except for facilities on the Navajo Reservation or on the Goshute Reservation which should submit an application to EPA Region IX.

SECTION III - SITE ACTIVITY INFORMATION If the storm water discharges to a municipal separate storm sewer system (MS4), enter the name of

the operator of the MS4 (e.g., the name of the City or County of jurisdiction) and the receiving water of the discharge from the MS4 if it is known (if it is not known look it up at <http://wq.deq.utah.gov>). (An MS4 is defined as a conveyance or system of conveyances (including roads with drainage systems, municipal streets, catch basins, curbs, gutters, ditches, man-made channels, or storm drains) that is owned or operated by a state, city, town, county, district, association or other public body which is designed or used for collecting or conveying storm water).

For Impaired Waters: Go to <http://wq.deq.utah.gov> and identify the water body that will receive the storm water discharge from the permitted site, on the map provided at the web site (zoom in for easier resolution). On the left hand side of the page you will see “2010 Assessment” or “2013 Assessment” depending on the year you refer to the web site (the assessment is done every 3 years). The 20XX Assessment will indicate if the water is impaired. If there is nothing after 20XX Assessment or the narrative after does not include the word “impaired”, your receiving water is not impaired.

For High Quality Waters: On the web page referred to in the paragraph above on the left hand side of the page you will see “Anti-Degradation Category”. Under Anti-Degradation Category you will see the category of the water body. Only categories 1 and 2 are high quality water bodies. Some waters may be both categories 1 and 3. If your water body is both category 1 and 3 it means the headwaters of your water body is within Forest Service boundaries, and because it is within Forest Service boundaries it is category 1. If your project is within Forest Service boundaries then your water body is category 1 and it is “high quality”. If your project is not within Forest Service boundaries then your water body is category 3 and is not “high quality”. Again, category 1 waters are high quality waters, category 3 waters are not high quality waters.

SECTION IV – LISTING LOTS FOR SUBDIVISIONS For the sake of tracking lots that are sold (if a developer chooses to sell lots to another party before the building construction for the lot is completed), and permitted under a different owner (which requires a different permit), developers must list lot numbers.

SECTION V - TYPE OF CONSTRUCTION Check each type of construction that applies to this application.

SECTION VI - BEST MANAGEMENT PRACTICES Check each type of best management practice that will be used to control storm water runoff at the job site.

SECTION VII – GOOD HOUSEKEEPING PRACTICES Check each type of good housekeeping practice that you will use on the site any time during construction activities.

SECTION VIII – ADDITIONAL Provide an estimate of the total number of acres of the site on which soil will be disturbed (to the nearest hundredth of an acre). An email address is required of the best contact associated with the project for the communication needs.

SECTION IX – CERTIFICATION State statutes provide for severe penalties for submitting false information on this application form. State regulations require this application to be signed as follows:

For a corporation: by a responsible corporate officer, which means: (i) president, secretary, treasurer, or vice-president of the corporation in charge of a principal business function, or any other person who performs similar policy or decision making functions, or (ii) the manager of one or more manufacturing, production, or operating facilities employing more than 250 persons or having gross annual sales or expenditures exceeding \$25 million (in second quarter 1980 dollars), if authority to sign documents has been assigned or delegated to the manager in accordance with corporate procedures;

For a partnership or sole proprietorship: by a general partner or the proprietor; or

For a municipality, state, Federal, or other public facility: by either a principal executive officer or ranking elected official.

POLLUTION PREVENTION PLAN A storm water pollution prevention plan (SWPP3) is required to be in hand before the NOI can be submitted. It is important to know SWPPP requirements (contained in the permit) even during the design portion of the project. A copy of the permit can be obtained from the Division of Water Quality’s storm water construction web site. Guidance material for developing a SWPPP can be obtained from the Division of Water Quality’s storm water construction web site.

APPENDIX D: Daily Self-Inspection Log (permit part 3.2.2).

APPENDIX E: Inspection Reports

Include BMPs inspected even if they are in good condition. Corrections must be completed before the next weekly inspection.

Weekly Inspection/Corrective Action Log						
Date & Time of Inspection	Weather	BMP # and Name	Description of BMP Condition or Deficiency	Initial	Correction Date (MM/DD/YY)	Ho Co

APPENDIX F: Additional Information

For permits such as local permits, dewatering, stream alteration, wetland, and out of date SWPPP documents, delegation of authority forms, etc.

Delegation of Authority

I, _____ (name), hereby designate the person or specifically described position below to be a duly authorized representative for the purpose of overseeing compliance with environmental requirements, including the Common Plan Permit, at the _____ construction site. The designee is authorized to sign any reports, storm water pollution prevention plans and all other documents required by the permit.

_____ (name of person or position)

_____ (company)

_____ (address)

_____ (city, state, zip)

_____ (phone)

By signing this authorization, I confirm that I meet the requirements to make such a designation as set forth in _____ (Reference State Permit), and that the designee above meets the definition of a "duly authorized representative" as set forth in _____ (Reference State Permit).

I certify under penalty of law that this document and all attachments were prepared under my direction or supervision in accordance with a system designed to assure that qualified personnel properly gathered and evaluated the information submitted. Based on my inquiry of the person or persons who manage the system, or those persons directly responsible for gathering the information, the information submitted is, to the best of my knowledge and belief, true, accurate, and complete. I am aware that there are significant penalties for submitting false information, including the possibility of fine and imprisonment for knowing violations.

Name:

Company:

Title:

Signature:

Date:

APPENDIX G: BMP Specifications and Details

Label BMPs to match the sections identified in this document.

STORM WATER POLLUTION PREVENTION PLAN (SWPPP)

STOR
PREVENTI

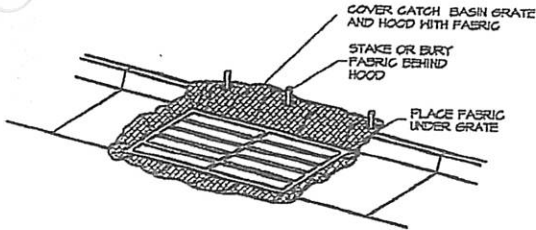

FABRIC UNDER GRATE

MAINTENANCE: LIFT GRATE & CLEAN SEDIMENT OFF OF FABRIC WEEKLY & AFTER A STORM. TAKE CARE WHILE LIFTING GRATE TO PREVENT SEDIMENT FROM FALLING INTO THE CATCH BASIN. DISPOSE OF SEDIMENT AWAY FROM THE STORM DRAIN.

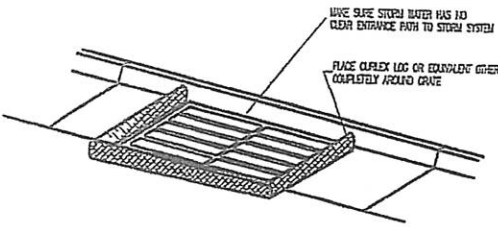

CURLEX LOG (STRAW/CLOTH SACK)

MAINTENANCE: REMOVE & CLEAN CURLEX LOGS THOROUGHLY EACH WEEK OR AFTER A STORM. TAKE CARE WHILE MOVING ROCK SOCKS TO PREVENT SEDIMENT FROM FALLING INTO THE CATCH BASIN. DISPOSE OF SEDIMENT AWAY FROM THE STORM DRAIN.

INLET PROTECTION

NOTES:

1. USE FABRIC UNDER GRATE TO PROTECT THE CATCH BASIN FROM SEDIMENTATION.

CONSTRUCTION & BMP SEQUENCING

BMP INSPECTION AND MAINTENANCE SHALL BEGIN WITH THE INSTALLATION OF THE FIRST BMP AND CONTINUE UNTIL THE LAST BMP (REVEGETATION) HAS BEEN COMPLETED.

CATCH BASIN PROTECTION

1. CATCH BASIN PROTECTION PER DETAIL LABELED "CURLEX LOG" AND/OR "FABRIC UNDER GRATE" SHALL BE INSTALLED UPON COMPLETION OF STORM DRAIN CONSTRUCTION.
 - A. FOR CATCH BASINS LOCATED IN CURB AND GUTTER:
 - i. "CURLEX LOG" SHALL REMAIN IN PLACE UNTIL CURB AND GUTTER IS CONSTRUCTED.
 - ii. CATCH BASIN PROTECTION PER DETAIL LABELED "FABRIC UNDER GRATE" SHALL BE INSTALLED UPON COMPLETION OF CURB AND GUTTER CONSTRUCTION, AND SHALL REMAIN IN PLACE UNTIL ALL PAVEMENT GRADING IS COMPLETED.
 - B. FOR CATCH BASINS LOCATED IN LANDSCAPE AREAS:
 - i. "CURLEX LOG" SHALL REMAIN IN PLACE UNTIL SITE GRADING OCCURS.
 - ii. CATCH BASIN PROTECTION PER DETAIL LABELED "CURLEX LOG" AND/OR "FABRIC UNDER GRATE" SHALL BE INSTALLED UPON COMPLETION OF SITE GRADING, AND SHALL REMAIN IN PLACE UNTIL ALL GRADING & LANDSCAPING IS COMPLETED.

CONCRETE WASTE MANAGEMENT

1. A CONCRETE WASTE MANAGEMENT FACILITY SHALL BE CONSTRUCTED PRIOR TO POURING ANY CONCRETE ON THE SITE, AND SHALL REMAIN IN PLACE UNTIL THE LAST CONCRETE POUR HAS BEEN COMPLETED.
2. CONTRACTOR IS TO REMOVE THE CONCRETE WASTE MANAGEMENT FACILITY BY LEGALLY REMOVING AND DISPOSING OF WASTE CONCRETE AND, IF NECESSARY, ANY NON-SOL BERM MATERIALS.

REVEGETATION

1. SEEDING AND PLANTING OF THE SITE PER THE LANDSCAPE PLAN SHALL OCCUR WITHIN 14 DAYS OF COMPLETION OF THE FINISH GRADING, IF SAID 14 DAYS OCCUR BETWEEN APRIL 15 AND SEPTEMBER 15. OTHERWISE, SEEDING AND PLANTING SHALL BEGIN APRIL 15.
2. PLANTING EFFORTS SHALL BE COMPLETED WITHIN 15 DAYS.
3. SEEDING AND PLANTING SHALL BE CONSIDERED COMPLETE WHEN 70% OF PLANTINGS ARE ESTABLISHED.

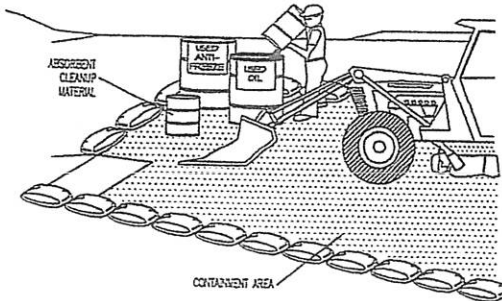

EQUIPMENT MAINTENANCE/REPAIR

NOTES:

1. LEAKING VEHICLES AND EQUIPMENT SHALL NOT BE ALLOWED ON-SITE. EQUIPMENT AND VEHICLES SHALL BE INSPECTED FREQUENTLY FOR LEAKS AND SHALL BE REPAIRED IMMEDIATELY. CLEAN UP SPILLS AND LEAKS PROMPTLY WITH ABSORBENT MATERIALS. DO NOT FLUSH WITH WATER.
2. VEHICLES AND EQUIPMENT SHALL BE MAINTAINED, AND REPAIRED ON-SITE ONLY IN DESIGNATED AREAS. PREVENT RUN-ON AND RUN-OFF FROM DESIGNATED AREAS.
3. CONTAINMENT DEVICES SHALL BE PROVIDED AND AREAS SHALL BE COVERED IF NECESSARY.
4. DESIGNATE ON-SITE VEHICLE AND EQUIPMENT MAINTENANCE AREAS, AWAY FROM STORM DRAIN INLETS AND WATERCOURSES.
5. ALWAYS USE SECONDARY CONTAINMENT, SUCH AS A CRASH PAN OR DEEP CLOTH TO CATCH SPILLS AND LEAKS WHEN REMOVING OR CHANGING FLUIDS. LEGALLY DISPOSE OF USED OILS, FLUIDS AND LUBRICANTS.
6. PROVIDE SPILL CONTAINMENT DEVICES OR SECONDARY CONTAINMENT AROUND STORED OIL, FUEL, AND CHEMICAL DRUMS.
7. MAINTAIN AN ADEQUATE SUPPLY OF ABSORBENT SPILL CLEANUP MATERIALS IN DESIGNATED AREAS.

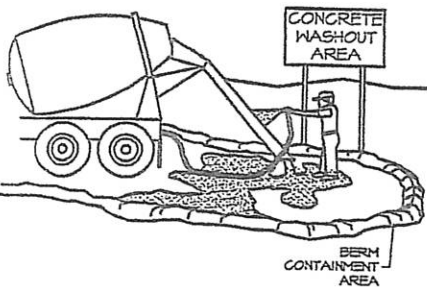

CONCRETE WASTE MANAGEMENT

NOTES:

1. EXCESS AND WASTE CONCRETE SHALL NOT BE WASHED INTO THE STREET OR INTO A DRAINAGE SYSTEM.
2. FOR WASHOUT OF CONCRETE AND MORTAR PRODUCTS, A DESIGNATED CONTAINMENT FACILITY OF SUFFICIENT CAPACITY TO RETAIN LIQUID AND SOLID WASTE SHALL BE PROVIDED ON SITE. THIS DISCHARGE AREA MUST BE LINED WITH AN IMPERMEABLE BARRIER.
3. SLURRY FROM CONCRETE AND ASPHALT SAW CUTTING SHALL BE VACUUMED OR CONTAINED, STORED, PACKED UP, AND DISPOSED OF PROPERLY.

1. THIS STORM WATER POLLUTION PREVENTION PLAN (SWPPP) WAS DEVELOPED AT THE REQUEST OF THE OWNER FOR THE CONSTRUCTION OF RESIDENTIAL CONSTRUCTION IN WEBER COUNTY, STATE OF UTAH. THIS PLAN IDENTIFIES POTENTIAL SOURCES OF POLLUTANTS OF STORM WATER, PRESENTS POLLUTION CONTROL MEASURES, AND ASSISTS IN ENSURING IMPLEMENTATION AND MAINTENANCE OF THE BEST MANAGEMENT PRACTICES (BMP'S) INDICATED HEREIN.

2. A NOTICE OF INTENT SHALL BE FILED WITH THE STATE OF UTAH DIVISION OF WATER QUALITY BY THE OWNER SO THAT THIS CONSTRUCTION PROJECT MAY BE COVERED UNDER THE STATE GENERAL PERMIT. THE PERMIT IS UTAH POLLUTION DISCHARGE ELIMINATION SYSTEM (UPDES) GENERAL PERMIT (DAI UTR 300000) FOR STORM WATER DISCHARGES ASSOCIATED WITH CONSTRUCTION ACTIVITY. PERMIT FEE'S ARE AVAILABLE FOR DOWNLOAD FROM THE DEPARTMENT OF ENVIRONMENTAL QUALITY AT WWW.STATEOFUTAH.GOV/UPDES/SWGNALDLPF

3. IN THE EVENT OF A CHANGE IN OWNERSHIP, A NEW NOTICE OF INTENT SHALL BE FILED WITH THE DIVISION OF WATER QUALITY.

4. IN THE EVENT OF A RELEASE OF A REPORTABLE QUANTITY OF A POLLUTANT, THE CONTRACTOR SHALL ADVISE THE OWNER TO NOTIFY THE UTAH RESPONSE CENTER, WEBER COUNTY, AND SILVERPEAK ENGINEERING IF NECESSARY, THIS SWPPP SHALL BE REVISED TO REFLECT THE CHANGE IN CONDITIONS OF THE CONSTRUCTION ACTIVITY. A REPORTABLE QUANTITY IS ESTABLISHED BY 40 CODE OF FEDERAL REGULATIONS (CFR) 1173 OR 40 CFR 302.4.

5. ALL CONTRACTORS AND THEIR PERSONNEL WHOSE WORK CAN CONTRIBUTE TO OR CAUSE POLLUTION OF STORM WATER SHALL BE MADE FAMILIAR WITH THIS SWPPP PLAN. ADEQUATE TRAINING FOR IMPLEMENTATION OF THE MEASURES PRESENTED HEREIN SHALL BE PROVIDED TO THE CONTRACTORS AND THEIR PERSONNEL. ALL CONTRACTORS AND SUBCONTRACTORS, EVEN ON RESIDENTIAL CONSTRUCTION WITH DISTURBED AREAS LESS THAN ONE ACRE, SHALL ABIDE BY THIS SWPPP.

6. CHANGES IN CONSTRUCTION OR IN CONDITIONS WHICH ARE NOT COVERED BY THIS SWPPP SHALL BE BROUGHT TO THE ATTENTION OF THE OWNER, SOIL AND INVESTMENTS AND DEVELOPMENT AND SILVERPEAK ENGINEERING IF NECESSARY. THIS SWPPP WILL BE REVISED TO REFLECT THE CHANGE IN CONSTRUCTION OR IN CONDITIONS.

7. ALL PREVENTION AND CLEAN UP MEASURES SHALL BE CONDUCTED IN ACCORDANCE WITH WEBER COUNTY ORDINANCES, AS WELL AS STATE AND FEDERAL REGULATIONS. WASTE MATERIALS SHOULD BE DISPOSED OF IN A LEGAL MANNER. ALL DISCHARGERS OF STORM WATER MUST COMPLY WITH THE LAWFUL REQUIREMENTS OF WEBER COUNTY REGARDING THE DISCHARGES OF STORM WATER TO STORM DRAINS.

8. THIS SWPPP DOES NOT COVER THE REMOVAL OF HAZARDOUS OR TOXIC WASTE. IN THE EVENT OF A DISCHARGE OR RELEASE OF A REPORTABLE QUANTITY OF TOXIC WASTE, WORK SHALL BE STOPPED UNTIL THE SPILL CAN BE ASSESSED AND A LIAISON REPORT PREPARED BY A QUALIFIED ENVIRONMENTAL CONSULTANT, AND IF NECESSARY, REVIEWED BY WEBER COUNTY AND ANY OTHER AGENCY HAVING JURISDICTION.

9. THIS SWPPP SHALL BE MADE AVAILABLE TO THE PUBLIC UNDER SECTION 306(b) OF THE CLEAN WATER ACT. UPON REQUEST BY MEMBERS OF THE PUBLIC, THE DISCHARGER SHALL MAKE AVAILABLE FOR REVIEW A COPY OF THIS SWPPP OTHER TO THE DIVISION OF WATER QUALITY OR DIRECTLY TO THE REQUESTER. THIS SWPPP MUST BE KEPT ON SITE DURING CONSTRUCTION ACTIVITY AND MADE AVAILABLE UPON REQUEST OF A REPRESENTATIVE OF THE DIVISION OF WATER QUALITY AND/OR THE LOCAL AGENCY.

CONTACTS

CONTRACTOR/DISCHARGER	KTR BOLEDO
TELEPHONE	(801) 497-1746
STATE OF UTAH DEPARTMENT OF ENVIRONMENTAL QUALITY DIVISION OF WATER QUALITY	228 NORTH 1460 WEST P.O. BOX 144870 SALT LAKE CITY, UTAH 84114-4870
U.S. EPA ENVIRONMENTAL PROTECTION AGENCY CENTER, COLUMBIA	REGION 10 800-753-4372
ENVIRONMENTAL PROTECTION AGENCY WASHINGTON, D.C. 20460	202-475-5516

REFERENCES

- A. PLAN PER SILVERPEAK ENGINEERING.
 - B. STORMWATER POLLUTION PREVENTION PLAN PREPARED BY SILVERPEAK ENGINEERING.
12. THE PROPOSED CONSTRUCTION ACTIVITY IS THE DESTRUCTION OF ONE HOUSE PLUS THE CONSTRUCTION OF ALL IMPROVEMENTS, UTILITIES, AND DRAINAGE AND GRADING FEATURES AS SHOWN ON THE PLANS.
 13. THE ESTIMATED RUN-OFF COEFFICIENT AFTER COMPLETION IS 0.35.
 14. A REDUCIBLE AMOUNT OF WATER FLOWS ONTO THE SITE.

SEAL:

DATE: PROJECT: DRAWING: C.D. DATE: 01-30-2011
DRAWING DESCRIPTION: STORM WATER POLLUTION PREVENTION NOTES

177 E. ANTELOPE DR. HB
LAYTON, UT 84041
PHONE: (801) 499-5054
FAX: (801) 499-5065

SILVERPEAK
ENGINEERING

SHEET NUMBER: C5.1

DATE: PROJECT: DRAWING: C.D. DATE: 01-30-2011
DRAWING DESCRIPTION: STORM WATER POLLUTION PREVENTION NOTES

STORM WATER POLLUTION PREVENTION PLAN SPECIFIC NOTES

DEVELOPED AT THE RESIDENTIAL CONSTRUCTION FEES PRESENTS POLLUTION PREVENTION AND MAINTENANCE OF HEREIN. EACH DIVISION OF WATER PROJECT MAY BE COVERED FOR POLLUTION DISCHARGE (FE 20000) FOR STORM WATER. REPORT FEES ARE AVAILABLE UPON REQUEST AT

IF A POLLUTANT, THE RESPONSE CENTER, THE SUFFP SHOULD BE NOTIFIED OF THE CONSTRUCTION ACTIVITY. SPECIAL REGULATIONS MAY APPLY TO OR BE REQUIRED BY THE SUFFP PLAN. CONTRACTORS SHALL BE RESPONSIBLE FOR OBTAINING ALL NECESSARY PERMITS AND COMPLIANCE WITH ALL REGULATIONS. CONTRACTORS SHALL KEEP COUNTY RECORDS OF ALL PERMITS AND COMPLIANCE WITH ALL REGULATIONS.

IF THIS PROJECT IS SUBJECT TO THE SUFFP PLAN, CONTRACTORS SHALL BE RESPONSIBLE FOR OBTAINING ALL NECESSARY PERMITS AND COMPLIANCE WITH ALL REGULATIONS. CONTRACTORS SHALL KEEP COUNTY RECORDS OF ALL PERMITS AND COMPLIANCE WITH ALL REGULATIONS.

IF THIS PROJECT IS SUBJECT TO THE SUFFP PLAN, CONTRACTORS SHALL BE RESPONSIBLE FOR OBTAINING ALL NECESSARY PERMITS AND COMPLIANCE WITH ALL REGULATIONS. CONTRACTORS SHALL KEEP COUNTY RECORDS OF ALL PERMITS AND COMPLIANCE WITH ALL REGULATIONS.

IF THIS PROJECT IS SUBJECT TO THE SUFFP PLAN, CONTRACTORS SHALL BE RESPONSIBLE FOR OBTAINING ALL NECESSARY PERMITS AND COMPLIANCE WITH ALL REGULATIONS. CONTRACTORS SHALL KEEP COUNTY RECORDS OF ALL PERMITS AND COMPLIANCE WITH ALL REGULATIONS.

IF THIS PROJECT IS SUBJECT TO THE SUFFP PLAN, CONTRACTORS SHALL BE RESPONSIBLE FOR OBTAINING ALL NECESSARY PERMITS AND COMPLIANCE WITH ALL REGULATIONS. CONTRACTORS SHALL KEEP COUNTY RECORDS OF ALL PERMITS AND COMPLIANCE WITH ALL REGULATIONS.

IF THIS PROJECT IS SUBJECT TO THE SUFFP PLAN, CONTRACTORS SHALL BE RESPONSIBLE FOR OBTAINING ALL NECESSARY PERMITS AND COMPLIANCE WITH ALL REGULATIONS. CONTRACTORS SHALL KEEP COUNTY RECORDS OF ALL PERMITS AND COMPLIANCE WITH ALL REGULATIONS.

A. PROTECTION ON MOST NON-STORM WATER DISCHARGES

ONLY STORM WATER FROM THE PROJECT SITE SHALL BE ALLOWED TO FLOW INTO THE ON-SITE STORM DRAIN SYSTEM. CLEAN WATER FROM THE FLUSHING OF FIRE HYDRANTS, WATER WANS, AND STORM DRAINS MAY BE DISCHARGED TO THE STORM DRAIN IF IT IS NOT ALLOWED TO COLLECT DIRT, DEBRIS, AND TRASH WHILE FLOWING TO A STORM DRAIN INLET.

B. POTENTIAL SOURCES OF STORM WATER POLLUTANTS

POTENTIAL STORM WATER POLLUTANTS INCLUDE SOIL, SEDIMENT AND NUTRIENTS, OIL, GREASE, TOXIC POLLUTANTS, AND HEAVY METALS. SOURCES OF STORM WATER POLLUTANTS INCLUDE BUT ARE NOT LIMITED TO SOIL EROSION BY WATER AND/OR WIND, CLEARING OF VEGETATION, GRADING, VEHICLE AND EQUIPMENT FUELING AND MAINTENANCE, WASHING OF CONCRETE TRUCKS, WAGERS AND HANDLING EQUIPMENT, PAINTS, SOLVENTS AND ADHESIVES, AND LANDSCAPING WORK.

C. EROSION AND SEDIMENT CONTROLS

- COVER EXPOSED STOCKPILES OF SOIL, CONSTRUCTION AND LANDSCAPING MATERIALS WITH HEAVY PLASTIC SHEETING.
- IN LANDSCAPING AREAS WHERE THE VEGETATION HAS NOT ESTABLISHED GROUND AND TACK HOLD, CONSIDER SODDING OR DETT BEGINS AROUND THEIR PERIMETER TO INSURE THAT WATER WILL NOT BE CONVEYED TO A STORM DRAIN INLET.
- DISTURBED AREAS SHALL BE SEED BY THE DEVELOPER. SLY BARRIERS SHALL BE MAINTAINED BY THE DEVELOPER IN THE MEAN TIME, OR THE DEVELOPER SHALL RE-SEED DISTURBED AREAS AS THEY SEE FIT AND REMOVE THE SEDIMENT CONTROLS.
- THROUGHOUT CONSTRUCTION, CONTRACTOR SHALL DIVERT STORM WATER RUNOFF AROUND DISTURBED SOILS WITH BEGGS OR DETT STIPLES.

D. OTHER CONTROLS

- WASTE DISPOSAL
 - KEEP WASTE DISPOSAL CONTAINERS COVERED.
 - PROVIDE FOR THE REGULAR (OR MORE FREQUENT, IF NECESSARY) DISPOSAL OF WASTE CONTAINERS.
 - PROVIDE CONTAINERS AT CONVENIENT LOCATIONS AROUND THE SITE.
- SWEEPING OF SITE
 - FRONTAGE DAILY, IF NECESSARY, SWEEPING BY HAND OR MECHANICAL MEANS TO KEEP THE PAVED AREAS OF THE SITE FREE OF DIRT, DUST, AND DEBRIS AS NECESSARY DURING PERIODS OF CONSTRUCTION.
 - DISPOSE OF ACCUMULATED DIRT IN WASTE CONTAINERS, OR HULL IT OFF THE SITE TO A LANDFILL.
- SANITARY/SEPTIC DISPOSAL
PORTABLE TOILETS AND OTHER SANITARY FACILITIES SHALL BE SERVICED REGULARLY AND PUMPED CLEAN BY A WASTE DISPOSAL COMPANY. NO TOXIC OR HAZARDOUS WASTE SHALL BE DISPOSED OF IN A PORTABLE TOILET OR IN THE ON-SITE SANITARY SEWER. TOILETS SHALL BE ANCHORED AGAINST OVERTURNING.
- SPILLS
 - STORE ADEQUATE ABSORBENT MATERIALS, RAGS, BRUSHES, SHOVELS, AND WASTE CONTAINERS ON THE SITE TO CLEAN-UP SPILLS OF MATERIALS SUCH AS FUEL, PAINT, SOLVENTS, OR CLEANERS. CLEAN UP SPILLS IMMEDIATELY.
 - FOR REPORTABLE QUANTITIES OF HAZARDOUS OR TOXIC SUBSTANCE, SECURE THE SERVICES OF QUALIFIED PERSONNEL FOR CLEAN-UP AND DISPOSAL.

E. INSPECTION

- REGULAR INDIVIDUAL INSPECTION AND INSPECTION BEFORE AND AFTER STORMS
 - VISUALLY INSPECT THE SITE WEEKLY TO INSURE THAT STORM WATER INLETS ARE FREE OF DIRT AND DEBRIS.
 - BEFORE A STORM, INSPECT THE SITE TO INSURE THAT STORM WATER POLLUTION CONTROL MEASURES ARE IN PLACE.
 - AFTER A STORM, INSPECT ALL STORM WATER INLETS TO INSURE THAT THEY ARE CLEAR OF DIRT AND DEBRIS. CLEAN THOSE STORM WATER INLETS THAT ARE NOT CLEAR AND FREE OF DEBRIS.
 - IN THE EVENT OF WATER QUALITY MAY REQUIRE THE DISCHARGER TO CONDUCT ADDITIONAL SITE INSPECTIONS, SUBMIT REPORTS AND CERTIFICATIONS, OR TO PERFORM SAMPLING AND ANALYSES.
- CONDUCT INSPECTIONS OF THE CONSTRUCTION SITE PRIOR TO ANTICIPATED STORM EVENTS AND AFTER ACTUAL STORM EVENTS, TO IDENTIFY AREAS CONTRIBUTING TO A STORM WATER DISCHARGE, TO EVALUATE WHETHER MEASURES TO REDUCE POLLUTANT LOADINGS IDENTIFIED IN THIS SUFFP ARE ADEQUATE, TO PROPERLY IMPLEMENT IN ACCORDANCE WITH THE TERMS OF THE GENERAL PERMIT, AND TO DETERMINE WHETHER ADDITIONAL CONTROL PRACTICES ARE NEEDED.
- PREPARATION OF REPORTS AND RETENTION OF RECORDS
 - EACH DISCHARGER MUST CERTIFY ANNUALLY THAT ITS CONSTRUCTION ACTIVITY IS IN COMPLIANCE WITH THE REQUIREMENTS OF THE GENERAL PERMIT AND THIS SUFFP. THIS CERTIFICATION MUST BE BASED ON I-2E SITE INSPECTIONS. THE FIRST CERTIFICATION MUST BE COMPLETED BY JULY 1, 2009, AND EACH JULY 1 THEREAFTER.
 - THE DISCHARGER IS REQUIRED TO RETAIN RECORDS OF ALL NECESSARY INFORMATION, COPIES OF ALL REPORTS REQUESTED BY THIS GENERAL PERMIT, AND RECORDS OF ALL DATA USED TO COMPLETE THE NOTICE OF INTENT FOR CONSTRUCTION ACTIVITY FOR A PERIOD OF AT LEAST THREE YEARS. THIS PERIOD MAY BE EXTENDED BY REQUEST OF THE STATE. WITH THE EXCEPTION OF NON-COMPLIANCE REPORTING, DISCHARGERS ARE NOT REQUIRED TO SUBMIT THE RECORDS EXCEPT UPON SPECIFIC REQUEST BY THE STATE DEPARTMENT OF WATER QUALITY.
 - DISCHARGERS WHO CANNOT CERTIFY COMPLIANCE MUST NOTIFY THE STATE DEPARTMENT OF WATER QUALITY. THIS NOTIFICATION SHALL IDENTIFY THE TYPE OF TYPES OF NON-COMPLIANCE, DESCRIBE THE ACTIONS NECESSARY TO ACHIEVE COMPLIANCE, AND INCLUDE A TIME SCHEDULE. SUBJECT TO THE MODIFICATIONS BY THE STATE DEPARTMENT OF WATER QUALITY, INDICATING WHEN COMPLIANCE WILL BE ACHIEVED. NON-COMPLIANCE REPORTS MUST BE SUBMITTED WITHIN 30 DAYS OF THE IDENTIFICATION OF THE NON-COMPLIANCE.

F. MAINTENANCE OF CONTROLS

- MAINTENANCE AND REPAIR ALL CONTROLS AND MEASURES IDENTIFIED ON THIS PLAN SHALL BE MAINTAINED IN GOOD AND EFFECTIVE CONDITION. IF ANY CONTROLS OR MEASURES ARE DAMAGED OR REMOVED, THEY SHALL BE PROMPTLY REPAIRED OR RESTORED.
- PLAN REVISIONS IF CONSTRUCTION ACTIVITY OR CONDITIONS CHANGE FROM THOSE SHOWN IN THIS PLAN, THEN THIS PLAN SHALL BE REVISED TO REFLECT THE CURRENT CONDITIONS.
- FINAL STABILIZATION AND POST-CONSTRUCTION CONTROLS
 - AFTER CONSTRUCTION HAS BEEN COMPLETED, THE SITE SHALL BE SWEPT CLEAN, STORM WATER INLETS (GRATES AND BASINS) SHALL BE CLEANED, AND ALL WASTE AND LEFTOVER MATERIALS SHALL BE REMOVED FROM THE SITE.
 - ALL LANDSCAPING AND PLANTING AREAS SHALL BE WELL MAINTAINED TO PREVENT EXCESSIVE SOIL OVER WATERSHED OF LANDSCAPING.
 - ALL PAVED AREAS SHALL BE SWEEP WEEKLY EITHER BY HAND OR BY MECHANICAL MEANS TO KEEP THE SITE CLEAR OF DIRT, DUST, AND DEBRIS.
 - WASTE MATERIALS ON-SITE SHALL BE STORED IN COVERED CONTAINERS WHICH ARE CLEANED OUT REGULARLY.
 - TESTING OF FIRE HYDRANTS ON-SITE SHALL NOT BE CONDUCTED UNTIL THE AREA WHERE THE WATER DISCHARGES HAS BEEN SWEPT CLEAN OF DIRT AND DEBRIS.
 - STORM DRAIN LINES SHALL BE CHECKED AND CLEANED ANNUALLY TO KEEP THEM CLEAR AND FREE OF DEBRIS.
 - ALL ON-SITE STORM WATER INLETS SHOULD BE CLEARLY MARKED "STORM WATER ONLY".

G. COMPLETION OF CONSTRUCTION ACTIVITIES AND NOTICE OF TERMINATION

WHEN CONSTRUCTION ACTIVITIES HAVE BEEN COMPLETED ON THIS SITE, THE OWNER SHALL FILE A LETTER WITH THE STATE DEPARTMENT OF WATER QUALITY. THIS LETTER SHALL CERTIFY THAT THE CONSTRUCTION ACTIVITY HAS BEEN COMPLETED, THAT ALL ELEMENTS OF THE SUFFP HAVE BEEN IMPLEMENTED, THAT CONSTRUCTION AND EQUIPMENT MAINTENANCE WASTES HAVE BEEN DISPOSED OF PROPERLY, THAT THE SITE IS IN COMPLIANCE WITH ALL LOCAL STORM WATER REQUIREMENTS INCLUDING EROSION/SEDIMENT CONTROL REQUIREMENTS, POLICES, AND ORDINANCES.

H. LANDSCAPING OPERATIONS

- USE ONLY THE MINIMUM AMOUNT OF LANDSCAPING FERTILIZERS, NUTRIENTS, AND OTHER CHEMICALS THAT ARE NEEDED.
- DO NOT OVER WATER FERTILIZED OR TREATED LANDSCAPE AREAS. MINIMIZE RUNOFF OF IRRIGATION WATER FROM LANDSCAPING.
- DO NOT PLACE LANDSCAPING MATERIAL IN THE STREET ORCE PAVING IS COMPLETE.

I. STORM WATER INLETS

CONTRACTOR SHALL PROVIDE STRAW FILLED BAGS OR ROCKS AROUND INLETS WITHIN 1000 FEET OF CONSTRUCTION AS BARRIERS TO PREVENT SEDIMENT ENTERING THE INLETS. TRAPPED SEDIMENT SHALL BE REMOVED FOLLOWING STORM EVENTS. BARRIERS SHALL BE REMOVED FOLLOWING COMPLETION OF CONSTRUCTION.

DEFINITIONS

- "BEST MANAGEMENT PRACTICES" (BMP'S) MEANS SCHEDULES OF ACTIVITIES, PROHIBITIONS OF PRACTICES, MAINTENANCE PROCEDURES, AND OTHER MANAGEMENT PRACTICES TO PREVENT OR REDUCE THE POLLUTION OF WATERS OF THE UNITED STATES. BMP'S ALSO INCLUDE TREATMENT REQUIREMENTS, OPERATING PROCEDURES, AND PRACTICES TO CONTROL SITE RUNOFF, SPILLAGE OR LEAKS, WASTE DISPOSAL, OR DRAINAGE FROM RAIN WATER STORAGE.
- "CLEAN WATER ACT" (CWA) MEANS THE FEDERAL WATER POLLUTION CONTROL ACT ENACTED BY PUBLIC LAW 92-500 AS AMENDED BY PUBLIC LAWS 95-217, 95-576, 95-483, AND 91-111; 33 USC 1251 ET SEQ.
- "CONSTRUCTION SITE" IS THE LOCATION OF THE CONSTRUCTION ACTIVITY.
- "NON-STORM WATER DISCHARGE" MEANS ANY DISCHARGE TO STORM DRAIN SYSTEMS THAT IS NOT COMPOSED ENTIRELY OF STORM WATER EXCEPT DISCHARGE PERMISSIBLE TO AN APPEAS PERMIT AND DISCHARGES RESULTING FROM FIRE FIGHTING ACTIVITIES.
- "SIGNIFICANT MATERIALS" INCLUDES, BUT IS NOT LIMITED TO RAIN MATERIALS, FUELS, MATERIALS SUCH AS SOLVENTS, DETERGENTS, AND PLASTIC PELLETS; FINISHED MATERIALS SUCH AS METALLIC PRODUCTS; RAW MATERIALS USED IN FOOD PROCESSING OR PRODUCTION HAZARDOUS SUBSTANCES DESIGNATED UNDER SECTION 101(14) OF THE COMPREHENSIVE ENVIRONMENTAL RESPONSE, COMPENSATION, AND LIABILITY ACT (CERCLA); ANY CHEMICAL THE FACILITY IS REQUIRED TO REPORT TO PERMIT PURSUANT TO SECTION 313 OF TITLE II OF SUPERFUND AMENDMENTS AND REAUTHORIZATION ACT (SARA); FERTILIZERS; PESTICIDES; AND WASTE PRODUCTS SUCH AS ASHES, SLAG, AND SLODGE THAT HAVE THE POTENTIAL TO BE RELEASED WITH STORM WATER DISCHARGES.
- "SIGNIFICANT QUANTITIES" IS THE VOLUME, CONCENTRATIONS, OR MASS OF A POLLUTANT IN STORM WATER DISCHARGE THAT CAN CAUSE OR THREATEN TO CAUSE POLLUTION, CONTAMINATION, OR IMPAIRMENT ADVERSELY AFFECT HUMAN HEALTH OR THE ENVIRONMENT; AND CAUSE OR CONTRIBUTE TO A VIOLATION OF ANY APPLICABLE WATER QUALITY STANDARDS FOR THE RECEIVING WATER.
- "STORM WATER" MEANS STORM WATER RUNOFF, SNOW MELT RUNOFF, SURFACE RUNOFF AND DRAINAGE, IT INCLUDES INFILTRATION AND RUNOFF FROM AGRICULTURAL LAND.
 - "POLLUTION" MEANS THE "MAN-MADE OR MAN-POUSED ALTERATION OF THE CHEMICAL, PHYSICAL, BIOLOGICAL, AND RADIOLOGICAL INTEGRITY OF WATER" (CLEAN WATER ACT SECTION 502(19)). POLLUTION ALSO MEANS "AN ALTERATION OF THE QUALITY OF THE WATERS OF THE STATE BY WASTE TO A DEGREE WHICH UNREASONABLY AFFECTS OTHER, THE WATERS FOR DOMESTIC USES, OR FACILITIES WHICH SERVE THESE DOMESTIC USES." (CALIFORNIA WATER CODE SECTION 13500(1)).
 - "CONTAMINATION" MEANS "AN IMPAIRMENT OF THE QUALITY OF THE WATERS OF THE STATE BY WASTE TO A DEGREE WHICH CREATES A HAZARD TO THE PUBLIC HEALTH THROUGH POISONING OR THROUGH THE SPREAD OF DISEASE, INCLUDING ANY EQUIVALENT EFFECT RESULTING FROM THE DISPOSAL OF WASTE, WHETHER OR NOT WATERS OF THE STATE ARE AFFECTED."
 - "NUISANCE" MEANS "ANYTHING WHICH MEETS ALL OF THE FOLLOWING REQUIREMENTS: (1) IS NOISIOUS TO HEALTH, OR IS NOISIOUS OR OFFENSIVE TO THE SENSES, OR AN OBSTRUCTION TO THE FREE USE OF PROPERTY, SO AS TO INTERFERE WITH THE COMFORTABLE ENJOYMENT OF LIFE AND PROPERTY; (2) AFFECTS AT THE SAME TIME AN ENTIRE COMMUNITY OR NEIGHBORHOOD, OR ANY CONSIDERABLE NUMBER OF PERSONS, ALTHOUGH THE EXTENT OF THE ANNOYANCE OR DAMAGE INFLECTED UPON INDIVIDUALS MAY BE UNUSUAL; (3) OCCURS DURING OR AS A RESULT OF THE TREATMENT OR DISPOSAL OF WASTES."
- "LOCAL AGENCY" MEANS ANY AGENCY THAT IS INVOLVED WITH REVIEW, APPROVAL, OR OVERSIGHT OF THE CONSTRUCTION SITE'S (a) CONSTRUCTION ACTIVITY, (b) EROSION AND SEDIMENT CONTROLS, (c) STORM WATER DISCHARGE.

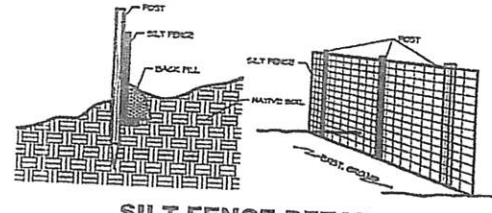

SILT FENCE DETAIL

Below are links to various Construction Storm Water BMP Manuals for reference.

Utah Department of Environmental Quality

<https://deq.utah.gov/legacy/permits/water-quality/utah-pollutant-discharge-elimination-system/example-appendix-g-bmp.htm>

Example Appendix G BMP Specifications and Details Construction Storm Water (UPDES)

Weber County

http://www.webercountyutah.gov/Engineering/swm/construction_bmp.php

Construction Best Management Practices

Salt Lake County

http://slco.org/uploadedFiles/depot/publicWorks/engineering/final_bmp_constructi.pdf

BEST MANAGEMENT PRACTICES FOR CONSTRUCTION ACTIVITIES

Davis County

http://www.daviscountyutah.gov/docs/librariesprovider20/default-document-library/stormwater-best-management-practices.pdf?sfvrsn=c9cd4053_2

A Guide to Storm water Best Management Practices

Nevada DOT

<https://www.nevadadot.com/home/showdocument?id=9417>

Storm water Quality Manuals: Construction Site Best Management Practices (BMPs) Manual

Caltrans

<http://www.dot.ca.gov/hq/construc/stormwater/CSBMP-May-2017-Final.pdf>

Construction Site Best Management Practices (BMP) Manual

Oregon

<http://www.oregon.gov/deq/FilterPermitsDocs/BMPManual.pdf>

Construction Storm water Best Management Practices Manual

Los Angeles

<http://dpw.lacounty.gov/cons/specs/BMPManual.pdf>

Construction Site Best Management Practices (BMPs) Manual