

EDGEWATER BEACH RESORT PHASE 1 AMENDMENT #2

A PLANNED RESIDENTIAL UNIT DEVELOPMENT (P.R.U.D.)

PART OF THE SOUTHWEST QUARTER OF SECTION 13, TOWNSHIP 6 NORTH, RANGE 1 EAST, SALT LAKE BASE AND MERIDIAN, U.S. SURVEY WEBER COUNTY, UT MAY 2016

TBC Curve Data

Table with 7 columns: #, Delta, Radius, Length, Tangent, Chord, CH.DST. Contains curve data for lines C1 through C54.

LINE TABLE with 3 columns: LINE #, LENGTH, DIRECTION. Contains line data for lines L1 through L37.

LINE TABLE with 3 columns: LINE #, LENGTH, DIRECTION. Contains line data for lines L38 through L105.

LINE TABLE with 3 columns: LINE #, LENGTH, DIRECTION. Contains line data for lines L106 through L140.

DEVELOPER

JACK FISHER HOMES BROCK LOOMIS 1148 W LEGACY CROSSING BLVD., STE 400 CENTERVILLE, UTAH 84014 801-335-8500

LAND USE

TOTAL AREA 161,453 S.F. (3.706 ACRES) COMMON AREA 128,833 S.F. (2.957 ACRES) 80% ROAD AREA 33,970 S.F. (0.779 ACRES) OPEN AREA 94,863 S.F. (2.269 ACRES) LIMITED COMMON AREA 7,100 S.F. (0.106 ACRES) 4% PRIVATELY OWNED BUILDING 25,520 S.F. (0.586 ACRES) 16%



VICINITY MAP NO SCALE

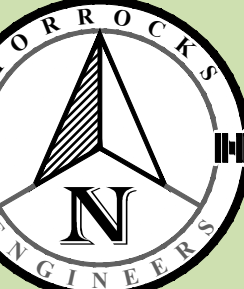

NARRATIVE

THE PURPOSE OF THIS PLAT IS TO DIVIDE THIS PROPERTY INTO LOTS AND STREETS, AND TO CREATE A SUBDIVISION PLAT. THE NORTH LINE WAS DETERMINED BY THE OWNER TO A FUTURE PHASE LINE. THE EAST LINE WAS DETERMINED BY THE PROPERTY OF THE UNITED STATES OF AMERICA, BUREAU OF LAND MANAGEMENT PARCEL 20-013-0007 ALONG A FENCELINE ON THE COMMON BOUNDARY BETWEEN THE PARCELS. THE SOUTH BOUNDARY IS ALONG THE RIGHT OF WAY FOR HIGHWAY 39 AS LOCATED BY A WEBER COUNTY SURVEY OF PINEVIEW FEDERAL BOUNDARY PROJECT NO. 003429 AND R.O.W. MARKER FOUND ON GROUND. ALL BOUNDARY CORNERS WERE SET WITH A 5/8" X 24" REBAR AND PLASTIC CAP STAMPED "HORROCKS ENGINEERING".

OWNERS DEDICATION AND CONSENT TO RECORD

KNOW ALL MEN BY THESE PRESENTS, CELTIC BANK, WHICH IS THE OWNER OF THE TRACT OF LAND DESCRIBED HEREIN ON AND EDGEWATER BEACH RESORT PHASE 1 - 1ST AMENDMENT, A PLANNED RESIDENTIAL UNIT DEVELOPMENT (PRUD) LOCATED ON SAID TRACT OF LAND, DO HEREBY MAKE THIS CERTIFICATE FOR AND ON BEHALF OF SAID CORPORATION AND HAVE CAUSED; 1. A SURVEY TO BE MADE AND 2. THIS PLANNED RESIDENTIAL UNIT DEVELOPMENT PLAT, CONSISTING OF (4) SHEETS, SAID CELTIC BANK DOES HEREBY CONSENT TO RECORD THIS PLANNED RESIDENTIAL UNIT DEVELOPMENT PLAT IN ACCORDANCE WITH THE UTAH CONDOMINIUM OWNERSHIP ACT; WE, THE UNDERSIGNED OWNERS OF THE HEREIN DESCRIBED TRACT OF LAND, DO HEREBY SET APART AND SUBDIVIDE THE SAME INTO UNITS AND PADS AND PUBLIC AND PRIVATE STREETS AS SHOWN HEREON AND NAME SAID TRACT EDGEWATER BEACH RESORT PHASE 1 - 2ND AMENDMENT, AND DO HEREBY:

DEDICATE TO PUBLIC USE ALL THOSE PARTS OR PORTIONS OF SAID TRACT OF LAND DESIGNATED AS PUBLIC STREETS, THE SAME TO BE USED AS PUBLIC THROUGHFARES, DEDICATE AND RESERVE UNTO THEMSELVES, THEIR HEIRS, THEIR GRANTEE AND ASSIGNS, A RIGHT--OF--WAY TO BE USED IN COMMON WITH ALL OTHERS WITHIN SAID SUBDIVISION (AND THOSE ADJOINING SUBDIVISIONS THAT MAY BE SUBDIVIDED BY THE UNDERSIGNED OWNERS, THEIR SUCCESSORS, OR ASSIGNS) ON, OVER AND ACROSS ALL THOSE PORTIONS OR PARTS OF SAID TRACT OF LAND DESIGNATED ON SAID PLAT AS PRIVATE STREETS AS ACCESS TO THE INDIVIDUAL UNITS AND PADS, TO BE MAINTAINED BY A UNIT AND PAD OWNERS ASSOCIATION WHOSE MEMBERSHIP CONSISTS OF SAID OWNERS, THEIR GRANTEE, SUCCESSORS, OR ASSIGNS GRANT AND CONVEY TO EDGEWATER BEACH RESORT PHASE 1 HOA, INC., ALL THOSE PARTS OR PORTIONS OF SAID TRACT OF LAND DESIGNATED AS COMMON AREAS TO BE USED FOR RECREATIONAL AND OPEN SPACE PURPOSES FOR THE BENEFIT OF EACH EDGEWATER BEACH RESORT PHASE 1 HOA, INC. MEMBER IN COMMON WITH ALL OTHERS IN THE SUBDIVISION AND GRANT AND DEDICATE TO WEBER COUNTY A PERPETUAL EASEMENT ON AND OVER THE COMMON AREAS TO GUARANTEE TO WEBER COUNTY THAT THE COMMON AREAS REMAIN OPEN AND UNDEVELOPED EXCEPT FOR APPROVED RECREATIONAL, PARKING AND OPEN SPACE PURPOSES. GRANT AND DEDICATE A PERPETUAL RIGHT AND EASEMENT OVER, UPON AND UNDER THE LANDS DESIGNATED HEREOF AS PUBLIC UTILITY, STORM WATER DETENTION PONDS, DRAINAGE EASEMENTS AND CANAL MAINTENANCE EASEMENT, THE SAME TO BE USED FOR THE INSTALLATION, MAINTENANCE AND OPERATION OF PUBLIC UTILITY SERVICE LINE, STORM DRAINAGE FACILITIES, IRRIGATION CANALS OR FOR THE PERPETUAL PRESERVATION OF WATER CHANNELS IN THEIR NATURAL STATE WHICHEVER IS APPLICABLE AS MAY BE AUTHORIZED BY THE GOVERNING AUTHORITY, WITH NO BUILDINGS OR STRUCTURES BEING ERRECTED WITHIN SUCH EASEMENTS. GRANT AND DEDICATE UNTO ALL OWNERS OF UNITS AND PADS UPON WHICH PRIVATE LAND DRAINS ARE CONSTRUCTED OR WHICH ARE OTHERWISE DEPENDENT UPON SUCH LAND DRAINS, AN EASEMENT OVER SUCH LAND DRAINS FOR THE PURPOSE OF PERPETUAL MAINTENANCE AND OPERATION. DEDICATE, GRANT AND CONVEY TO THE GOVERNING AUTHORITY, OR ITS DESIGNEE, ALL THOSE PARTS OR PORTIONS OF SAID TRACT OF LAND DESIGNATED AS PARKS THE SAME TO BE USED AS PUBLIC OPEN SPACE. ALL COMMON AREAS, INCLUDING THE PRIVATE STREETS, IS CONSIDERED TO BE AN EASEMENT FOR PUBLIC UTILITY AND DRAINAGE PURPOSES. NOTES NUMBER 1, 2, AND 7 ARE BY REFERENCE MADE A PART HEREOF AND INCORPORATED HEREIN.

ADDITIONAL PROPERTY OWNERS TO SIGN SEPARATE EXHIBITS TO BE RECORDED WITH THE PLAT

SIGNED THIS \_\_\_ DAY OF \_\_\_, A.D. 20\_\_\_ JEFFREY W. SHUGARS AND KRISTINA SHUGARS, AS JOINT TENANTS JAMES T. ROBERTS AND KATHERINE B. ROBERTS, AS JOINT TENANTS CELTIC BANK CORPORATION DAVID LEE TOWERS, A MARRIED MAN

Weber County Commission Acceptance

A SIGNATURE BLOCK FOR BOARD OF COUNTY COMMISSIONERS CONFORMING TO STATE CODE AND COUNTY ORDINANCES WEBER COUNTY COMMISSION ACCEPTANCE THIS IS TO CERTIFY THAT THIS SUBDIVISION PLAT, THE DEDICATION OF STREETS AND OTHER PUBLIC WAYS AND FINANCIAL GUARANTEE OF PUBLIC IMPROVEMENTS ASSOCIATED WITH THIS SUBDIVISION, THEREON ARE HERBY APPROVED AND ACCEPTED BY THE COMMISSIONERS OF WEBER COUNTY, UTAH THIS \_\_\_ DAY OF \_\_\_, 20\_\_\_ CHAIRMAN, WEBER COUNTY COMMISSION ATTEST: TITLE: \_\_\_\_\_

Please include the following note with the applicable information: Name of Subdivision is located within a Natural Hazards Area. A geologic investigation has been performed by Name of Geotech and Geologic Company (include date and job/project#(s)). The final report is available for public review at the Weber County Planning Division Office.

ELEVATION=4969.025' (MAINTAINED BY WEBER COUNTY SURVEYOR)

BASIS OF BEARINGS

THE BASIS OF BEARINGS FOR THIS PLAT IS THE SECTION LINE BETWEEN THE SOUTH QUARTER CORNER AND THE SOUTHWEST CORNER OF SECTION 13, TOWNSHIP 6 NORTH, RANGE 1 EAST, SALT LAKE BASE AND MERIDIAN, U.S. SURVEY. SHOWN HEREON AS N89°36'57"E.

WEBER COUNTY SURVEYOR

I HEREBY CERTIFY THAT THE WEBER COUNTY SURVEYOR'S OFFICE HAS REVIEWED THIS PLAT AND ALL CONDITIONS FOR APPROVAL BY THIS OFFICE HAVE BEEN SATISFIED. THE APPROVAL OF THIS PLAT BY THE WEBER COUNTY SURVEYOR DOES NOT RELIEVE THE LICENSED LAND SURVEYOR WHO EXECUTED THIS PLAT FROM THE RESPONSIBILITIES AND/OR LIABILITIES ASSOCIATED THEREWITH. SIGNED THIS \_\_\_ DAY OF \_\_\_, 20\_\_\_

WEBER COUNTY SURVEYOR

ACKNOWLEDGMENT

STATE OF UTAH ) SS COUNTY OF WEBER ) ON THIS THE \_\_\_ DAY OF \_\_\_, 20\_\_\_, PERSONALLY APPEARED BEFORE ME, THE UNDERSIGNED NOTARY PUBLIC, \_\_\_ THAT HE SIGNED THE OWNER'S DEDICATION AND CERTIFICATION, WHO BEING BY ME DULY SWORN, DID ACKNOWLEDGE TO ME \_\_\_ SIGNED IT FREELY, VOLUNTARILY AND FOR THE PURPOSES THEREIN MENTIONED.

NOTARY PUBLIC RESIDING IN WEBER COUNTY, STATE OF UTAH MY COMMISSION EXPIRES: \_\_\_\_\_

WEBER COUNTY PLANNING COMMISSION APPROVAL

THIS IS TO CERTIFY THAT THIS SUBDIVISION PLAT WAS DULY APPROVED BY WEBER COUNTY PLANNING COMMISSION SIGNED THIS \_\_\_ DAY OF \_\_\_, A.D. 20\_\_\_

CHAIRMAN, WEBER COUNTY PLANNING COMMISSION

WEBER COUNTY ENGINEER

I HERBY CERIFY THAT THE REQUIRED PUBLIC IMPROVEMENT STANDARDS AND DRAWINGS FOR THIS SUBDIVISION CONFORM WITH THE COUNTY STANDARDS AND THE AMOUNT OF THE FINANCIAL GUARANTEE IS SUFFICIENT FOR THE INSTALLATION OF THESE IMPROVEMENTS

WEBER COUNTY ENGINEER

WEBER COUNTY ATTORNEY

I HAVE EXAMINED THE FINANCIAL GUARANTEE AND OTHER DOCUMENTS ASSOCIATED WITH THIS SUBDIVISION PLAT, AND IN MY OPINION THEY CONFORM WITH THE COUNTY ORDINANCE APPLICABLE THERETO AND NOW IN FORCE AND AFFECT SIGNED THIS \_\_\_ DAY OF \_\_\_, A.D. 20\_\_\_

WEBER COUNTY ATTORNEY

MORGAN/WEBER HEALTH DEPT.

I HEREBY CERTIFY THAT THE SOILS, PERCOLATION RATES, AND SITE CONDITIONS FOR THIS SUBDIVISION HAVE BEEN INVESTIGATED BY THIS OFFICE, AND ARE APPROVED FOR ON-SITE WASTEWATER DISPOSAL SYSTEMS.

MORGAN/WEBER HEALTH DEPARTMENT

SURVEYOR'S CERTIFICATE

I, C. DAVID MCKINNEY, DO HEREBY CERTIFY THAT I AM A PROFESSIONAL LICENSED LAND SURVEYOR, AND THAT I HOLD A LICENSE IN ACCORDANCE WITH TITLE 58, CHAPTER 22, PROFESSIONAL ENGINEERS AND PROFESSIONAL LAND SURVEYORS LICENSING ACT, UTAH CODE ANNOTATED, 1953 AS AMENDED, LICENSE NO. 5251295; AND THAT I HAVE COMPLETED A SURVEY OF THE PROPERTY DESCRIBED ON THIS PLAT IN ACCORDANCE WITH SECTION 17-23-17 AND HAVE VERIFIED ALL MEASUREMENTS, AND HAVE PLACED MONUMENTS AS REPRESENTED ON THIS PLAT, AND THAT THIS PLAT OF EDGEWATER BEACH RESORT PHASE 1 - AMENDMENT #2 IN WEBER COUNTY, UTAH HAS BEEN DRAWN CORRECTLY TO THE DESIGNATED SCALE AND IS TRUE AND CORRECT REPRESENTATION OF THE HEREIN DESCRIBED LANDS INCLUDED IN SAID SUBDIVISION, BASED UPON DATA COMPILED FROM RECORDS IN THE WEBER COUNTY RECORDERS OFFICE AND FROM SAID SURVEY MADE BY ME ON THE GROUND, I FURTHER CERTIFY THAT THE REQUIREMENTS OF ALL APPLICABLE STATUTES AND ORDINANCES OF WEBER COUNTY CONCERNING ZONING REQUIREMENTS REGARDING LOT MEASUREMENTS HAVE BEEN COMPLIED WITH.



C. DAVID MCKINNEY PROFESSIONAL LAND SURVEYOR

10/31/17 DATE

BOUNDARY DESCRIPTION

PART OF THE SOUTHWEST QUARTER OF SECTION 13, TOWNSHIP 6 NORTH, RANGE 1 EAST, SALT LAKE BASE AND MERIDIAN, U.S. SURVEY, DESCRIBED AS FOLLOWS:

BEGINNING AT A POINT ON THE NORTH RIGHT OF WAY LINE OF STATE HIGHWAY 39, SAID POINT BEING N00°25'49"E 251.50 FEET AND S89°34'11"E 8.72 FEET FROM THE SOUTHWEST CORNER OF SECTION 13: THENCE N00°09'59"E 350.70 FEET; THENCE S89°34'11"E 103.01 FEET; THENCE N65°29'31"E 139.65 FEET TO A POINT ON A 66.72 FOOT RADIUS NON-TANGENT CURVE TO THE LEFT (RADIUS BEARING S44°00'46"E); THENCE RUNNING SOUTHWESTERLY ALONG SAID CURVE 60.50 FEET THROUGH A CENTRAL ANGLE OF 51°57'16" (CHORD S69°52'23"E 58.45') TO A POINT ON A LINE; THENCE S17°58'09"E 66.23 FEET; THENCE N72°01'51"E 28.00 FEET; THENCE S17°38'34"E 8.59 FEET TO A POINT ON A 15.0 FOOT RADIUS CURVE TO THE LEFT; THENCE RUNNING SOUTHWESTERLY ALONG SAID CURVE 22.64 FEET THROUGH A CENTRAL ANGLE OF 86°27'51" (CHORD S60°20'46"E 20.55') TO A POINT ON A LINE; THENCE S13°34'41"E 26.0 FEET; THENCE S18°32'05"E 88.52 FEET; THENCE S06°58'25"W 95.65 FEET; THENCE S17°56'43"W 87.35 FEET; THENCE S70°43'57"E 69.24 FEET; THENCE S17°56'43"W 128.53 FEET; THENCE S14°34'08"W 11.29 FEET TO THE NORTH RIGHT-OF-WAY LINE OF STATE HIGHWAY 39; THENCE ALONG SAID NORTH RIGHT-OF-WAY LINE THE FOLLOWING TWO (2) COURSES: (1) THENCE ALONG 1859.88 FOOT RADIUS CURVE TO THE RIGHT; THENCE RUNNING SOUTHWESTERLY ALONG SAID CURVE 80.87 FEET THROUGH A CENTRAL ANGLE OF 02°29'28" (CHORD N71°58'20"W 80.86') TO A POINT ON A LINE AND (2) N70°43'36"W 312.77 FEET TO THE POINT OF BEGINNING.

CONTAINING 161,460 SQUARE FEET OR 3.706 ACRES.

CORPORATE ACKNOWLEDGMENT

STATE OF UTAH ) SS COUNTY OF WEBER ) ON THIS THE \_\_\_ DAY OF \_\_\_, 20\_\_\_, PERSONALLY APPEARED BEFORE ME, THE UNDERSIGNED NOTARY PUBLIC, \_\_\_ THAT HE SIGNED THE OWNER'S DEDICATION FREELY AND VOLUNTARILY FOR AND IN BEHALF OF THE CORPORATION FOR THE PURPOSES THEREIN MENTIONED AND THAT THE CORPORATION EXECUTED THE SAME.

NOTARY PUBLIC RESIDING IN WEBER COUNTY, STATE OF UTAH MY COMMISSION EXPIRES: \_\_\_\_\_

ACKNOWLEDGMENT

STATE OF UTAH ) SS COUNTY OF WEBER ) ON THIS THE \_\_\_ DAY OF \_\_\_, 20\_\_\_, PERSONALLY APPEARED BEFORE ME, THE UNDERSIGNED NOTARY PUBLIC, \_\_\_ THAT HE SIGNED THE OWNER'S DEDICATION AND CERTIFICATION, WHO BEING BY ME DULY SWORN, DID ACKNOWLEDGE TO ME \_\_\_ SIGNED IT FREELY, VOLUNTARILY AND FOR THE PURPOSES THEREIN MENTIONED.

NOTARY PUBLIC RESIDING IN WEBER COUNTY, STATE OF UTAH MY COMMISSION EXPIRES: \_\_\_\_\_

EDGEWATER BEACH RESORT PHASE 1 - AMENDMENT #2

A PLANNED RESIDENTIAL UNIT DEVELOPMENT (P.R.U.D.)

SUBDIVISION PLAT FOR PART OF THE SOUTHWEST QUARTER OF SECTION 13, TOWNSHIP 6 NORTH

COUNTY ENGINEER'S SEAL

CLERK-RECORDER SEAL



SURVEYOR'S SEAL

COUNTY SURVEYOR

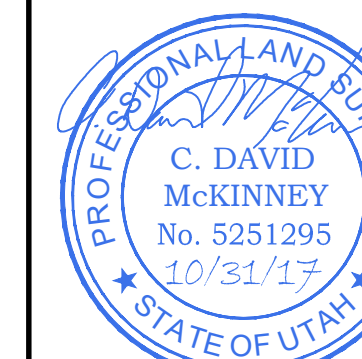

ENTRY NO: \_\_\_\_\_ FEE PAID: \_\_\_\_\_ FILED FOR RECORD AND RECORDED, AT \_\_\_\_\_ OF THE OFFICIAL RECORDS, PAGE \_\_\_\_\_ RECORDED FOR: \_\_\_\_\_ WEBER COUNTY RECORDER DEPUTY



**EDGEWATER BEACH RESORT  
PHASE 1 - AMENDMENT #2**

A PLANNED RESIDENTIAL UNIT DEVELOPMENT (P.R.U.D.)

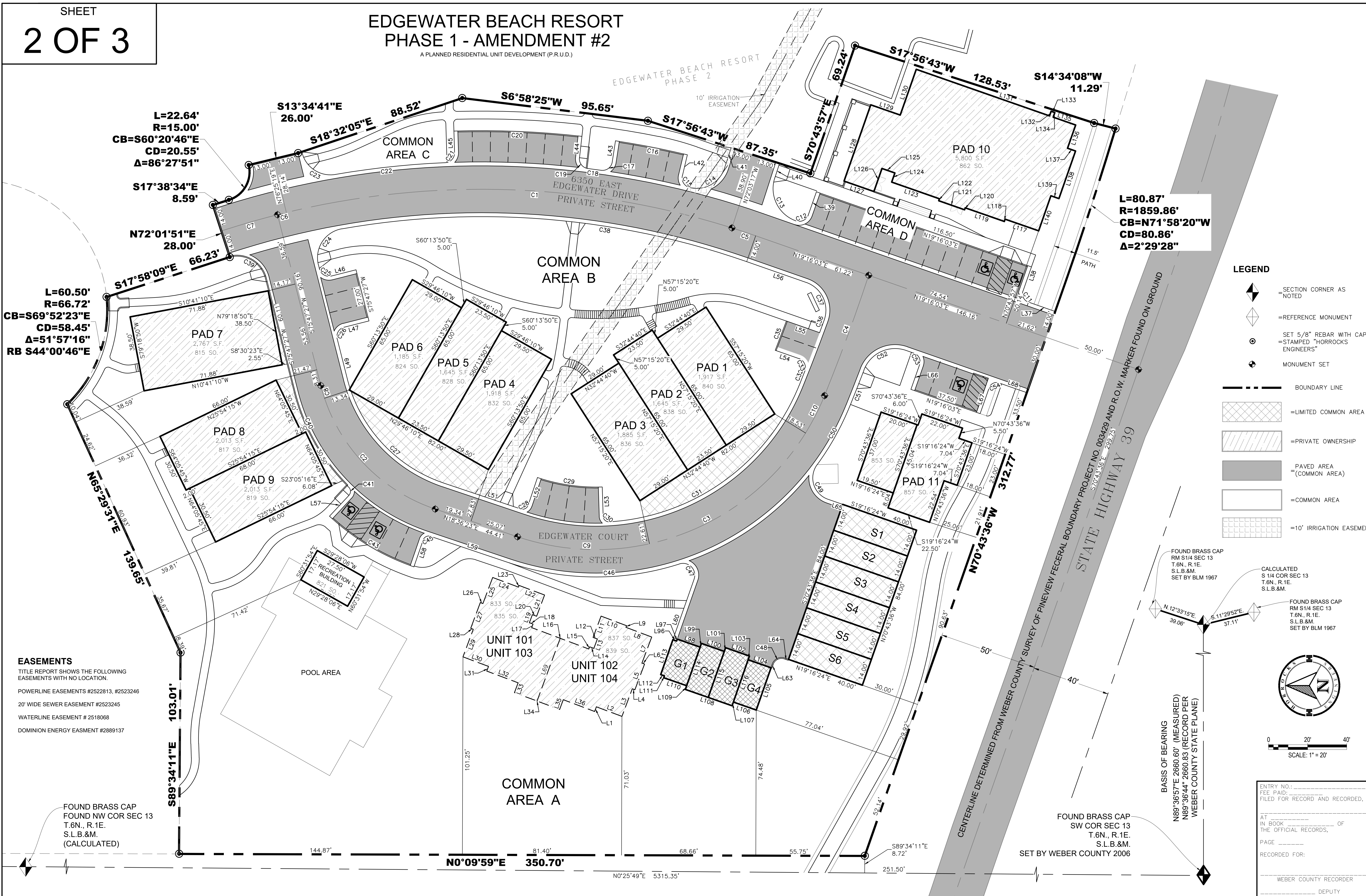

**L=22.64'**  
**R=15.00'**  
**CB=S60°20'46"E**  
**CD=20.55'**  
**Δ=86°27'51"**

**S17°38'34"E**  
**8.59'**

**N72°01'51"E**  
**28.00'**

**S17°58'09"E**  
**66.23'**

**L=60.50'**  
**R=66.72'**  
**CB=S69°52'23"E**  
**CD=58.45'**  
**Δ=51°57'16"**  
**RB S44°00'46"E**

**L=80.87'**  
**R=1859.86'**  
**CB=N71°58'20"W**  
**CD=80.86'**  
**Δ=2°29'28"**

- LEGEND**
- SECTION CORNER AS NOTED
  - =REFERENCE MONUMENT
  - SET 5/8" REBAR WITH CAP =STAMPED "HORROCKS ENGINEERS"
  - MONUMENT SET
  - BOUNDARY LINE
  - =LIMITED COMMON AREA
  - =PRIVATE OWNERSHIP
  - PAVED AREA (COMMON AREA)
  - =COMMON AREA
  - =10' IRRIGATION EASEMENT

**EASEMENTS**  
TITLE REPORT SHOWS THE FOLLOWING EASEMENTS WITH NO LOCATION.

POWERLINE EASEMENTS #2522813, #2523246  
20' WIDE SEWER EASEMENT #2523245  
WATERLINE EASEMENT # 2518068  
DOMINION ENERGY EASMENT #2889137

FOUND BRASS CAP  
RM S1/4 SEC 13  
T.6N., R.1E.  
S.L.B.&M.  
SET BY BLM 1967

CALCULATED  
S 1/4 COR SEC 13  
T.6N., R.1E.  
S.L.B.&M.

FOUND BRASS CAP  
RM S1/4 SEC 13  
T.6N., R.1E.  
S.L.B.&M.  
SET BY BLM 1967

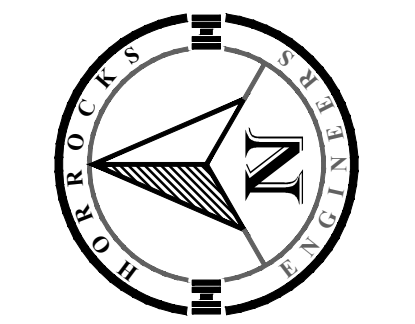

0 20' 40'  
SCALE: 1" = 20'

ENTRY NO.: \_\_\_\_\_  
FEE PAID: \_\_\_\_\_  
FILED FOR RECORD AND RECORDED.

AT \_\_\_\_\_  
IN BOOK \_\_\_\_\_ OF \_\_\_\_\_  
THE OFFICIAL RECORDS,

PAGE \_\_\_\_\_  
RECORDED FOR: \_\_\_\_\_

WEBER COUNTY RECORDER  
DEPUTY

FOUND BRASS CAP  
SW COR SEC 13  
T.6N., R.1E.  
S.L.B.&M.  
SET BY WEBER COUNTY 2006

BASIS OF BEARING  
N89°36'57"E 2660.60' (MEASURED)  
N89°36'44" 2660.83 (RECORD PER  
WEBER COUNTY STATE PLANE)

CENTERLINE DETERMINED FROM WEBER COUNTY SURVEY OF PINEVIEW FEDERAL BOUNDARY PROJECT NO. 003429 AND R.O.W. MARKER FOUND ON GROUND

STATE HIGHWAY 39

EDGEWATER BEACH RESORT  
PHASE 2

6350 EAST  
EDGEWATER DRIVE  
PRIVATE STREET

EDGEWATER COURT  
PRIVATE STREET

POOL AREA

RECREATION  
BUILDING  
821 S.O.

**N0°09'59"E**  
**350.70'**

N0°25'49"E 5315.35'

S89°34'11"E  
8.72'

**S89°34'11"E**  
**103.01'**

FOUND BRASS CAP  
FOUND NW COR SEC 13  
T.6N., R.1E.  
S.L.B.&M.  
(CALCULATED)



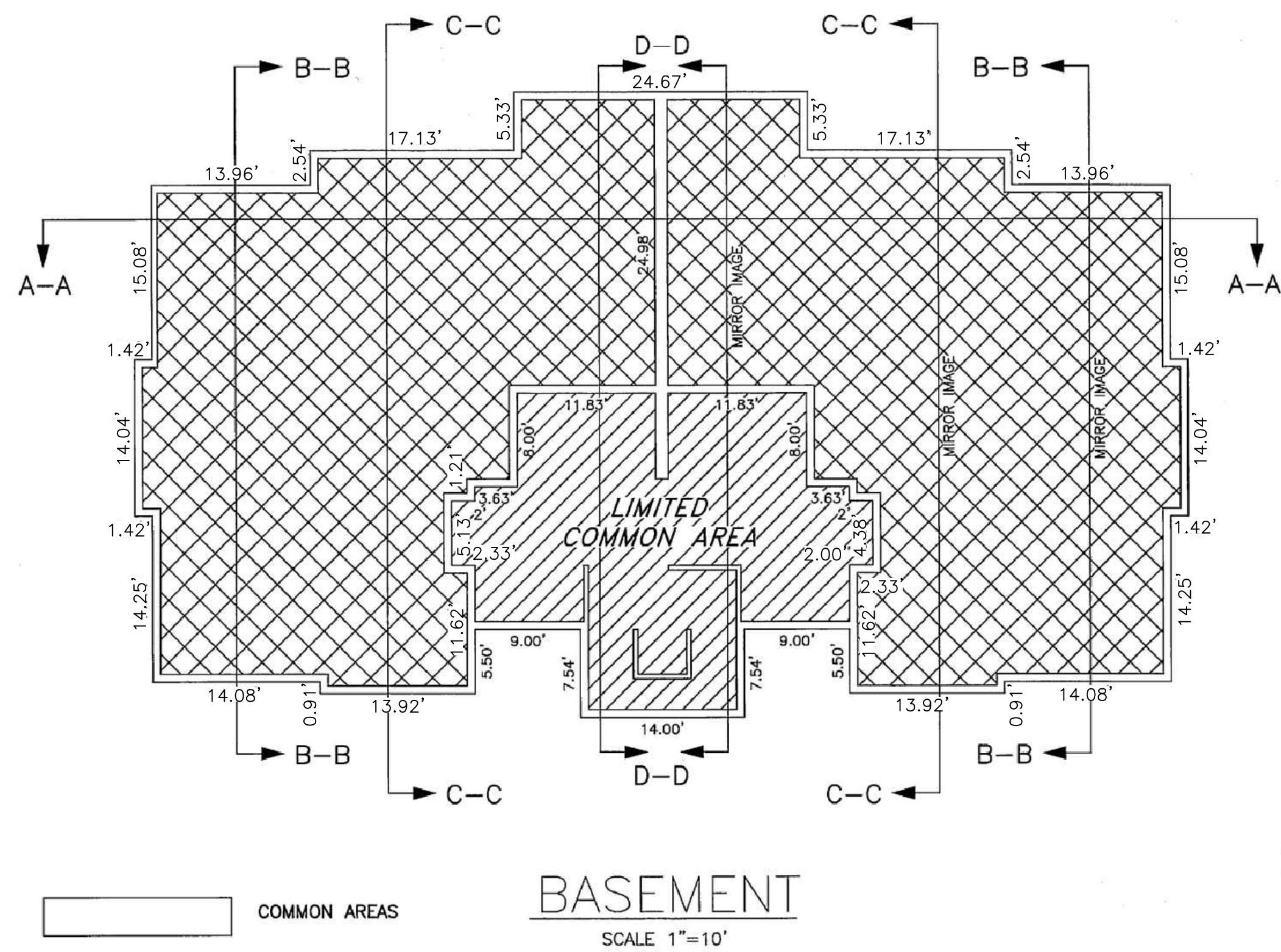
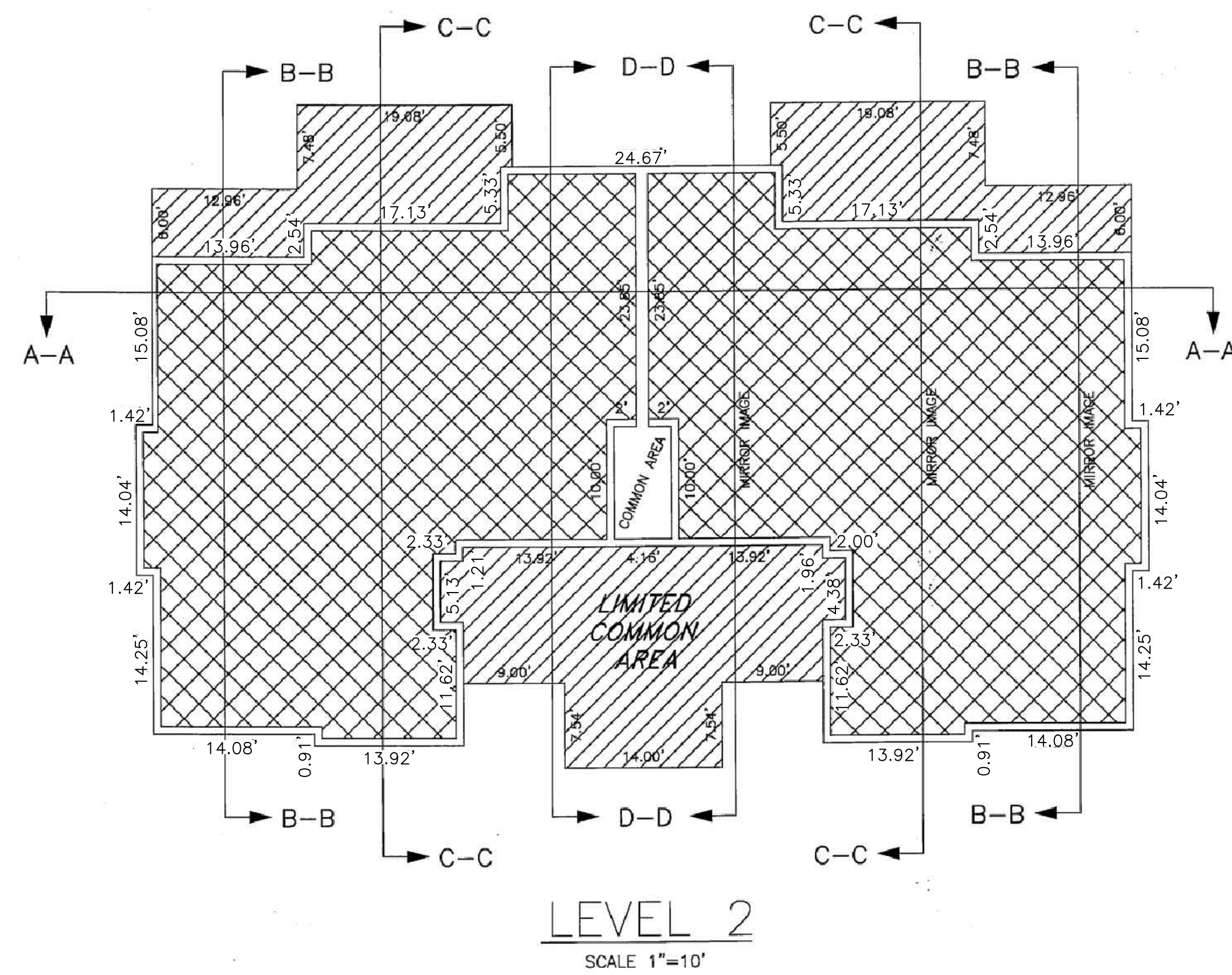
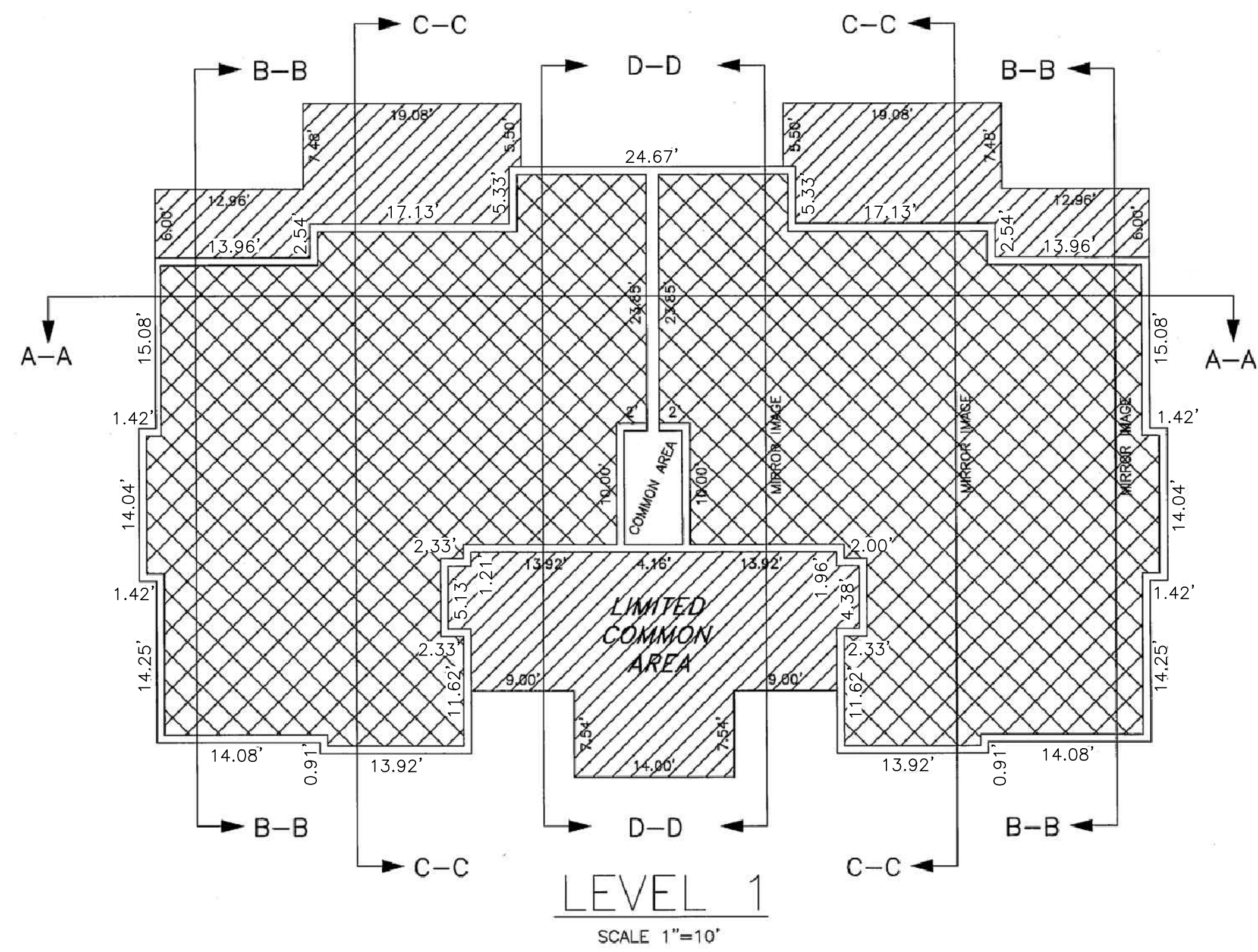

- COMMON AREAS
- LIMITED COMMON AREAS AND FACILITIES
- PRIVATE OWNERSHIP

CONDOMINIUM NOTES:  
UNITS 101-104 ARE CONDOMINIUM UNITS

ALL DRIVEWAYS, PATIOS, DECKS, BALCONIES ON UNITS 101-104 ARE CONSIDERED LIMITED COMMON AREA. THEY ARE SET ASIDE AND RESERVED FOR THE USE OF THE RESPECTIVE CONDOMINIUM UNIT TO WHICH THEY ARE ATTACHED OR APPURTENANT.

DIMENSIONS ON BUILDINGS VARY SLIGHTLY. AS-BUILT DIMENSIONS WILL CONTROL.

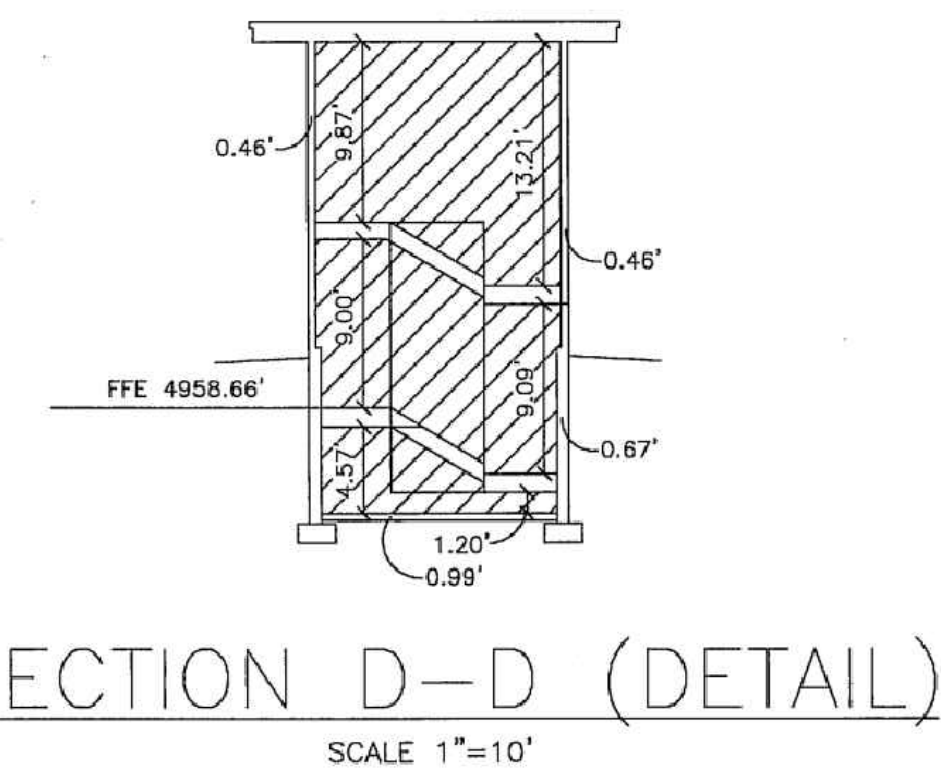
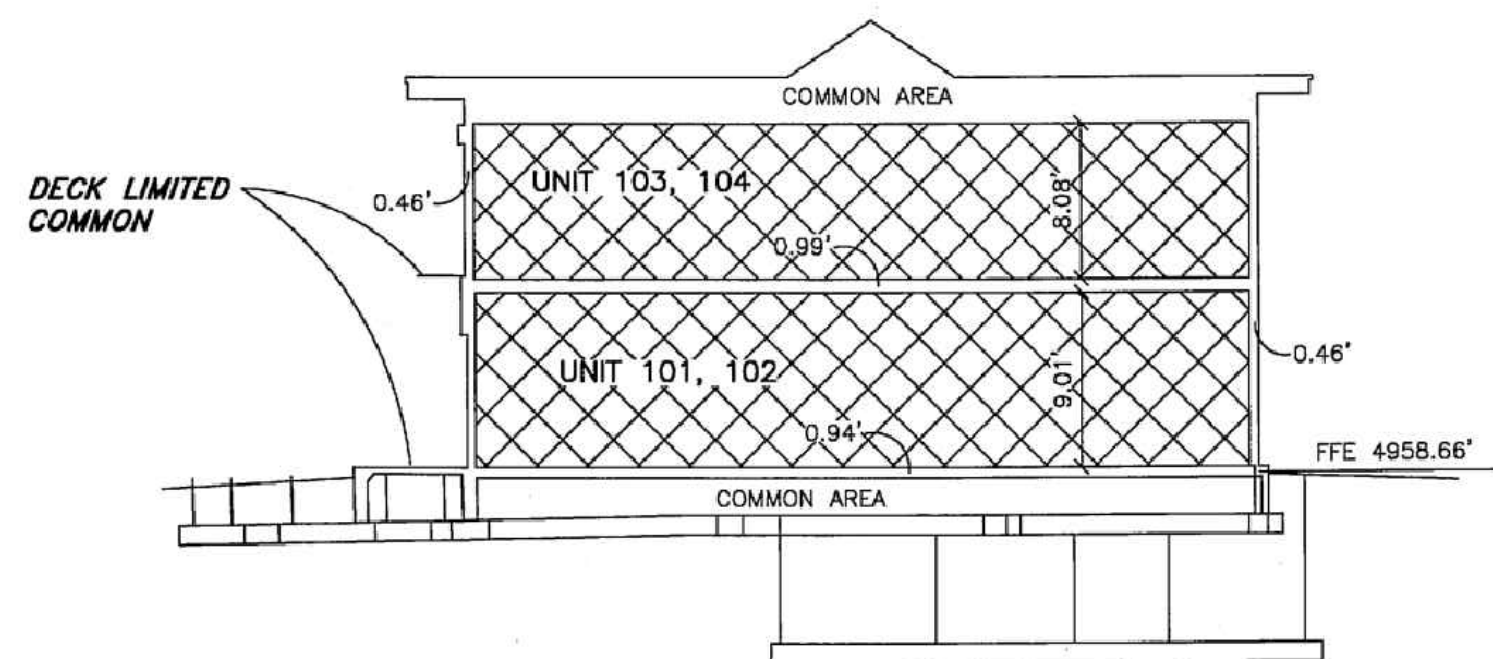
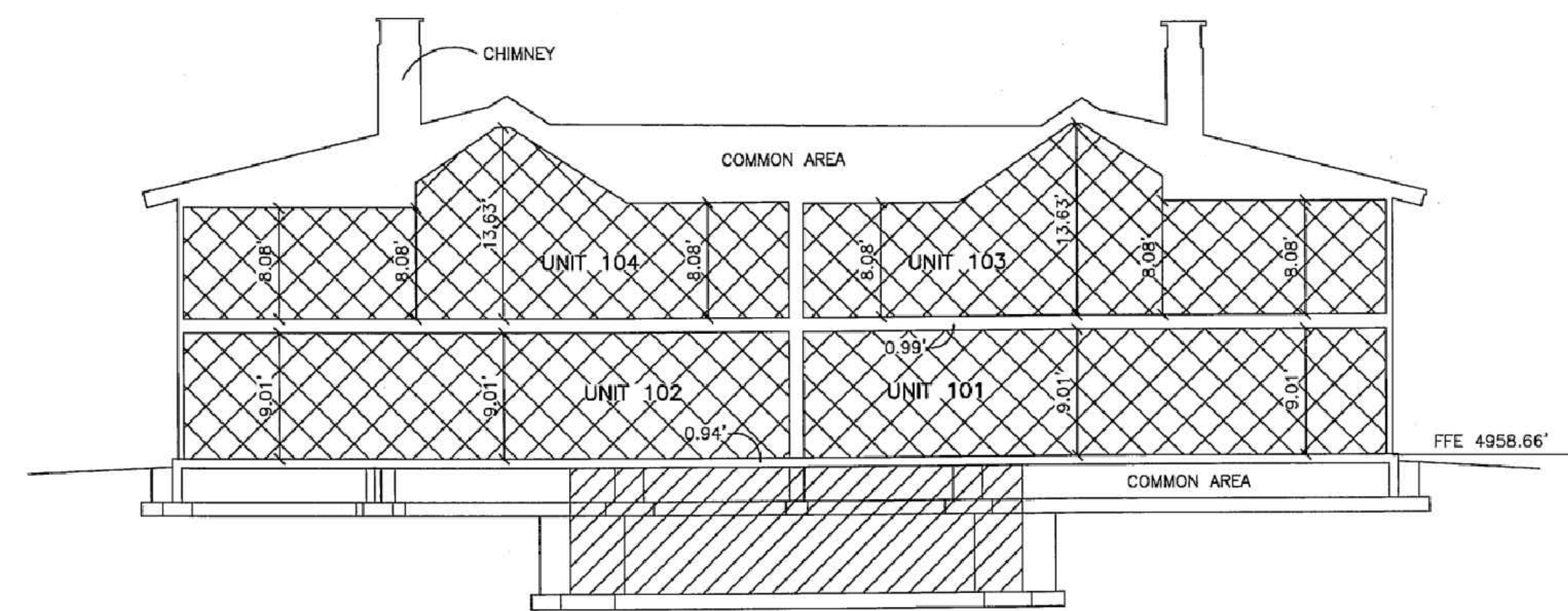
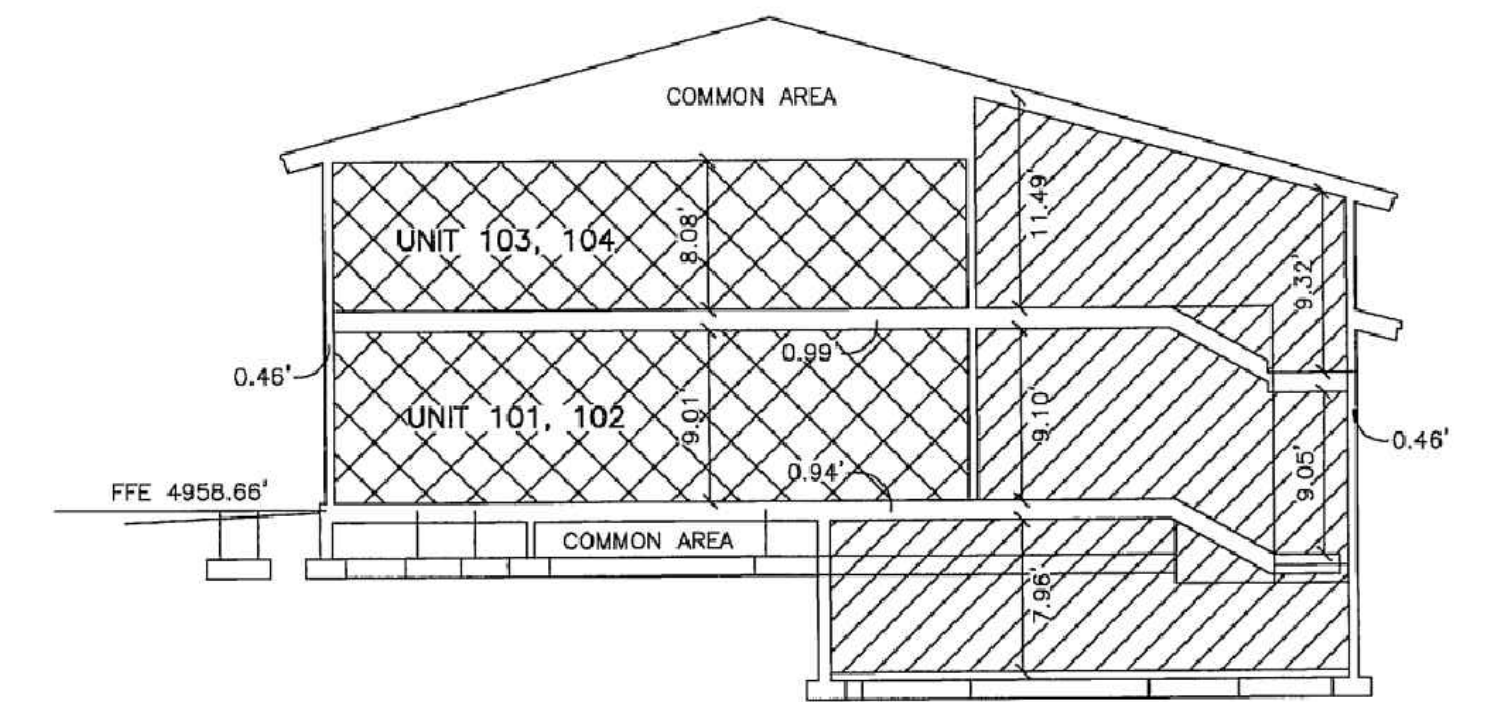
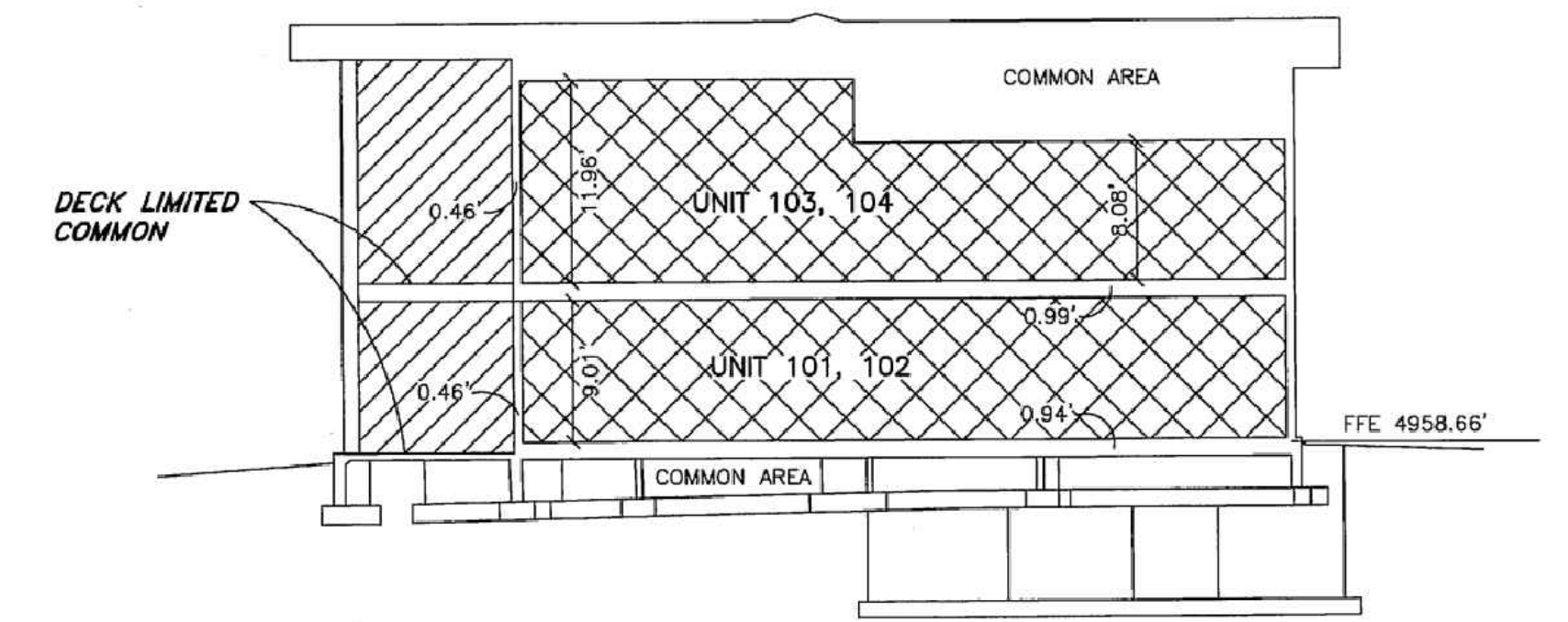

ENTRY NO: \_\_\_\_\_  
 FEE PAID: \_\_\_\_\_  
 FILED FOR RECORD AND RECORDED,  
 AT \_\_\_\_\_  
 IN BOOK \_\_\_\_\_ OF  
 THE OFFICIAL RECORDS,  
 PAGE \_\_\_\_\_  
 RECORDED FOR:  
 \_\_\_\_\_  
 WEBER COUNTY RECORDER  
 \_\_\_\_\_  
 DEPUTY