

Story Farm Subdivision

Weber County, Utah

A Part of the Northwest Quarter of Section 28,
Township 7 North, Range 1 East, S.L.B.&M.

Northwest Corner of Sec. 28,
T. 7 N., R. 1 E., SLB&M Fnd
Weber Co. Brass Cap Mon.
1981 Good Condition.

North Quarter Corner of Sec. 28,
T. 7 N., R. 1 E., SLB&M Fnd
Weber Co. Brass Cap Mon.
1976 Good Condition.

S 89°19'49" E Basis of Bearing - State Plane Grid Bearing per Weber Co. 2626.05 Meas. 2626.15' Weber Co.

PARCEL CURVE DATA											
SEGMENT	LENGTH	RADIUS	DELTA	CHORD LENGTH	CHORD BEARING	SEGMENT	LENGTH	RADIUS	DELTA	CHORD LENGTH	CHORD BEARING
C1	30.01'	437.92'	3°55'54"	30.00'	N32°08'56"W	C18	33.18'	33.27'	57°08'28"	31.82'	N74°01'06"E
C2	35.87'	33.34'	61°38'30"	34.16'	S70°38'53"E	C19	31.28'	197.48'	9°04'32"	31.25'	S72°52'24"E
C3	59.21'	181.77'	18°39'58"	58.95'	N02°47'56"W	C20	32.26'	32.81'	56°09'57"	30.99'	S83°54'54"W
C4	38.19'	28.48'	76°48'59"	35.40'	S31°52'28"E	C21	41.78'	25.02'	85°40'35"	37.10'	S78°39'47"E
C5	35.31'	319.00'	6°20'29"	35.29'	S75°39'15"E	C22	24.62'	35.32'	39°56'24"	24.12'	N48°47'42"W
C6	22.89'	62.84'	20°57'32"	22.86'	N68°20'44"W	C23	22.61'	47.18'	27°27'40"	22.40'	S85°02'04"E
C7	18.04'	188.85'	5°28'36"	18.03'	S60°35'16"E	C24	16.88'	18.54'	48°54'57"	16.18'	S16°50'55"E
C8	10.55'	14.48'	41°43'46"	10.32'	S84°10'28"E	C25	43.62'	28.54'	87°33'41"	39.50'	N36°10'27"W
C9	21.60'	70.15'	17°38'31"	21.51'	S18°36'22"E	C26	24.64'	29.62'	47°39'56"	23.94'	S76°12'45"W
C10	15.51'	276.23'	2°48'12"	15.51'	N11°11'12"W	C27	16.81'	33.13'	29°03'47"	16.63'	N68°54'40"E
C11	7.14'	8.81'	46°25'29"	6.94'	N35°48'02"W	C28	20.69'	39.72'	29°03'47"	20.46'	S69°51'21"W
C12	24.13'	20.43'	67°40'14"	22.75'	S25°10'40"E	C29	42.63'	75.30'	32°24'12"	42.07'	N67°48'15"E
C13	26.52'	161.44'	9°24'45"	26.48'	N03°57'04"E	C30	19.36'	17.57'	63°07'58"	18.40'	S84°25'50"E
C14	16.41'	16.90'	55°38'28"	15.78'	N28°34'33"W	C31	33.39'	59.14'	32°20'49"	32.93'	N49°02'28"W
C15	24.85'	104.34'	13°42'04"	24.89'	N63°14'49"W	C32	45.96'	1388.48'	1°55'23"	45.96'	S84°15'08"E
C16	68.22'	281.64'	14°30'04"	66.04'	N77°20'53"W	C33	24.40'	81.43'	17°10'04"	24.31'	S54°42'25"E
C17	26.37'	30.24'	49°57'13"	25.54'	S70°25'29"W						

PARCEL LINE DATA		
SEGMENT	DIRECTION	LENGTH
L1	N30°10'20"W	31.47'
L2	S78°51'52"W	9.50'
L3	N70°16'58"W	53.63'
L4	S74°57'40"W	3.98'

NARRATIVE

The purpose of this survey was to establish and set the property corners of the parcels as shown and described hereon creating a two (2) lot subdivision. The survey was ordered by Chuck and Brad Story. The R-O-W Lines for Highway 162 were established using the UDOT R-O-W drawings, existing R-O-W fence lines and the Marcum Subd. to the east and the Liberty Meadows Subd. to the west. The control used to establish the property corners was the existing Weber County Survey Monumentation surrounding Section 28, T7N, R1E, SLB&M. The basis of bearing is the North line of the Northwest Quarter of said Section which bears South 89°19'49" East, Utah North, State Plane, Calculated N.A.D.83 Bearing.

Vicinity Map

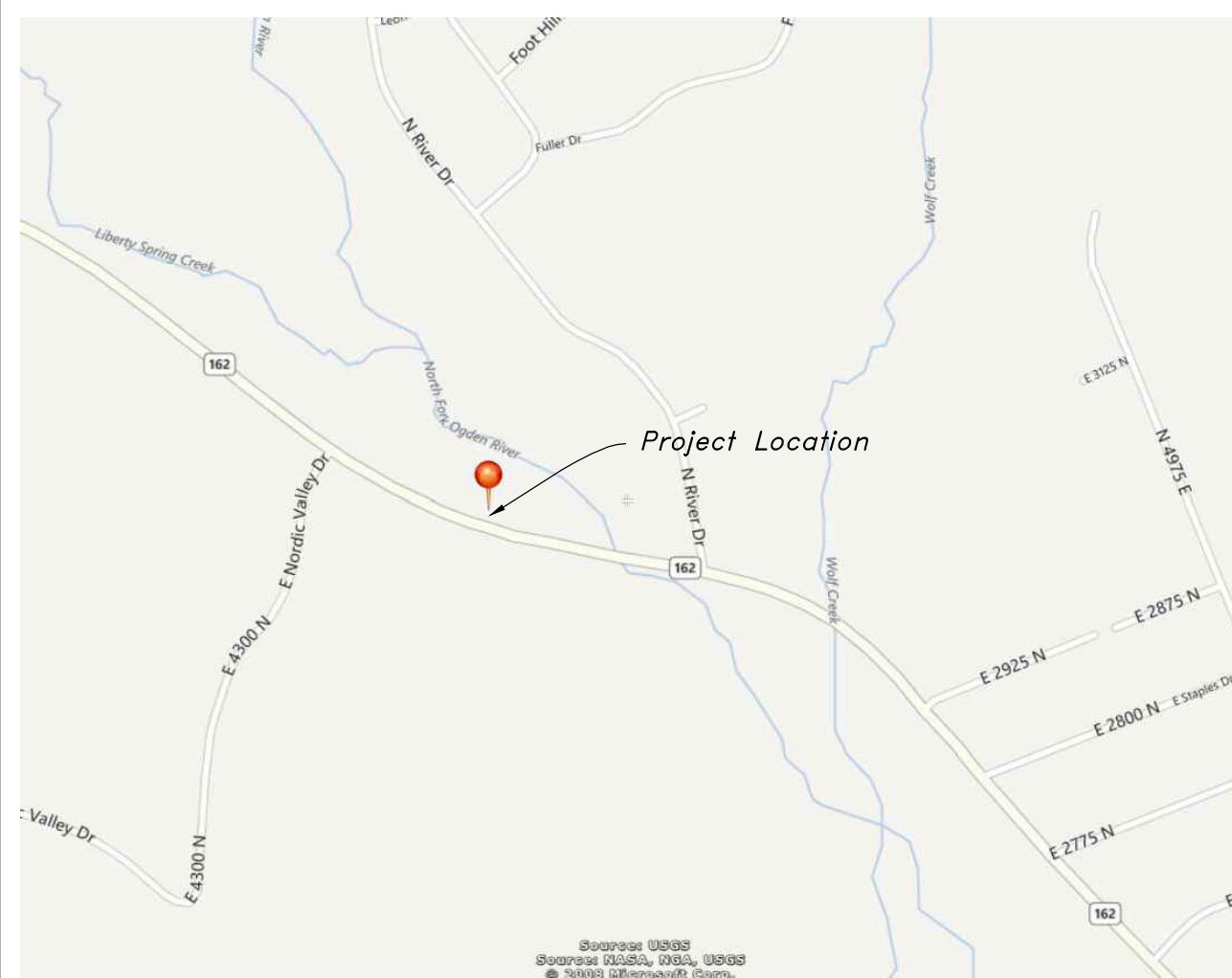

WEBER COUNTY PLANNING COMMISSION APPROVAL

This is to Certify that this Subdivision Plat was Duly Approved by the Weber County Planning Commission. Signed this _____ Day of _____, 2017

Chairman, Weber County Planning Commission

WEBER COUNTY ENGINEER

I Herby Certify that the Required Public Improvement Standards and Drawings for this Subdivision Conform with the County Standards and the Amount of the Financial Guarantee is Sufficient for the Installation of these Improvements. Signed this _____ Day of _____, 2017

Weber County Engineer

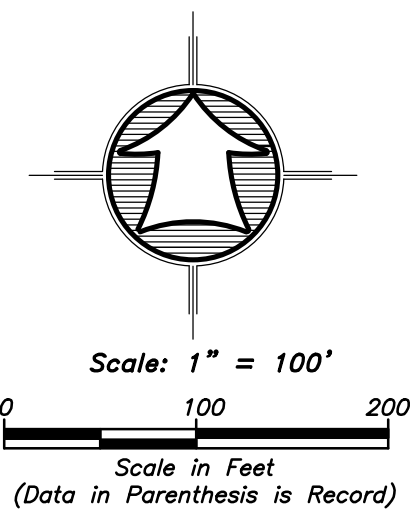

AGRICULTURAL NOTE

Agriculture is the preferred use in the Agriculture Zones. Agriculture operations as specified in the zoning ordinance for a particular zone are permitted at any time including the operation of farm machinery and no allowed agriculture use shall be subject to restriction on that it interferes with activities of future residents of this subdivision

WEBER COUNTY COMMISSION ACCEPTANCE

This is to Certify that this Subdivision Plat, the Dedication of Streets and other Public Ways and Financial Guarantee of Public Improvements Associated with this Subdivision, Thereon are Herby Approved and Accepted by the Commissioners of Weber County Utah Signed this _____ Day of _____, 2017

Chairman, Weber County Commission

Attest

WEBER COUNTY SURVEYOR

I hereby certify that the Weber County Surveyor's Office has reviewed this plat and all conditions for approval by this office have been satisfied. The approval of this plat by the Weber County Surveyor does not relieve the Licensed Land Surveyor who executed this plat from the responsibilities and/or liabilities associated therewith.

Signed this _____ Day of _____, 2017

Weber County Surveyor

WEBER COUNTY ATTORNEY

I have examined the financial guarantee and other documents associated with this subdivision plat and in my opinion they conform with the County Ordinance applicable thereto and now in force and effect. Signed this _____ Day of _____, 2017

Weber County Attorney

WEBER-MORGAN HEALTH DEPARTMENT

I Herby Certify that the Soils, Percolation Rates, and Site Conditions for this Subdivision have been Investigated by this Office and are Approved for On-Site Wastewater Disposal Systems. Signed this _____ Day of _____, 2017

Weber-Morgan Health Department

SURVEYOR'S CERTIFICATE

I, K. Greg Hansen, do Herby Certify that I am a Registered Professional Land Surveyor in the State of Utah in Accordance with Title 53, Chapter 22, Professional Engineers and Land Surveyors Act; and I Have Completed a Survey of the Property Described on this Plat in Accordance with Section 17-23-17 and have Verified all Measurements, and have Placed Monuments as Represented on this Plat, and have Herby Subdivided said Tract into Two (2) Lots, known Hereafter as Story Farm Subdivision in Weber County, Utah, and has been Correctly Drawn to the Designated Scale and is True and Correct Representation of the Herein Described Lands Included in said Subdivision, Based Upon Data Compiled from Records in the Weber County Recorder's Office and from said Survey made by me on the Ground, I Further Herby Certify that the Requirements of all Applicable Statutes and Ordinances of Weber County Concerning Zoning Requirements Regarding Lot Measurements have been Complied with.

Signed this _____ day of _____, 2017.

K Greg Hansen Utah Land Surveyor Licence No. 167819



BOUNDARY DESCRIPTION

A part of the Northwest Quarter of Section 28, Township 7 North, Range 1 East of the Salt Lake Base and Meridian. Beginning at an existing fence corner being a point on the Northeastly Right-of-Way Line of State Highway 162 Located South 89°19'49" East 1406.32 Feet along the North line of said Northwest Quarter and South 00°00'00" East 2002.08 Feet from the Northwest Corner of said Northwest Quarter; Running Thence along said fence line the following two (2) courses; (1) North 44°20'46" East (North 45° East by record) 256.74 Feet; and (2) North 02°44'05" East (North 01°31' East by record) 460.99 Feet to the southwest corner of the Spencer Ferrin Subdivision; Thence South 49°45'45" East 932.43 Feet along the south boundary line of said Spencer Ferrin Subdivision to the existing fence line accepted as the existing Property Line established by Boundary Line Agreement, Entry No. 2692286, Recorded June 24, 2014 in the files of the Weber County Recorder; Thence along said Boundary Line Agreement and fence line the following four (4) courses; (1) South 46°24'18" West 265.13 Feet; (2) North 59°48'17" West 78.85 Feet; (3) South 47°03'23" West 179.42 Feet; and (4) South 59°13'16" West 154.60 Feet to said Northeastly Right-of-Way Line of State Highway 162; Thence along said Northeastly Right-of-Way Line the following two (2) Courses; (1) North 51°59'25" West 418.93 Feet; and (2) Along the arc of a 2897.00 Foot Radius Curve to the Left 73.94 Feet, Having a Central Angle of 01°27'43", Chord Bears North 52°43'17" West 73.94 Feet to the point of beginning. Containing 9.24 Acres.

Subject a 30.00 Foot wide Ingress and Egress Easement along the west boundary line of the above described parcel of land recorded as Entry No. 2657083 in the file of Weber County Recorders office.

OWNER'S DEDICATION AND CERTIFICATION

Know all men by these presents that we, the undersigned Owners of the above described tract of land having caused the same to be subdivided into lots as shown on this plat and name said tract Story Farm Subdivision do hereby Grant and dedicate a perpetual right and easement over, upon and under the lands designated hereof as public utility, storm water detention ponds, drainage easements and canal maintenance easement, the same to be used for the installation maintenance and operation of public utility service lines, storm drainage facilities, irrigation canals or for the perpetual preservation of water channels in their natural state whichever is applicable as may be authorized by the governing authority, with no buildings or structures being erected within such easements.

Signed this _____ Day of _____, 2017

William C. Story

Dixie R. Story

ACKNOWLEDGMENT

State of Utah
County of _____

On this _____ day of _____, William C. Story and Dixie R. Story, Husband and Wife as Joint Tenants, Personally Appeared before me, the Undersigned Notary Public in and for said County of _____, in the State of Utah, the Signers of the Attached Owners Dedication, two in Numbers, who duly Acknowledged to me they Signed it Freely and Voluntarily and for the Purpose Therein Mentioned.

Notary Public

WEBER COUNTY RECORDER

ENTRY NO. _____ FEE PAID _____

FILED FOR RECORD AND

RECORDED _____

IN BOOK _____ OF OFFICIAL

RECORDS, PAGE _____ RECORDED

FOR _____

COUNTY RECORDER

BY: _____
DEPUTY



HANSEN & ASSOCIATES, INC.
Consulting Engineers and Land Surveyors
538 North Main Street, Brigham, Utah 84302
Visit us at www.haies.net
Brigham City Ogden Logan
(435) 723-3491 (801) 399-4905 (435) 752-8272 (435) 655-5660

Developer:
Brad Story
3192 No. Hwy 162
Eden, Utah 84310
(435) 655-5660