

(This SWPPP Template is for the **Common Plan** Permit Only, and
does **NOT** address SWPPP requirements found in the CGP.)

Common Plan SWPPP for Favero Legacy

3871 West 2200 South

Taylor Utah 84404

Bell Built Homes

4655 S 1900 w

Roy Utah 84067

Contractor Name (if not the same as Owner)

Contractor Street Address

Contractor City, State, Zip

Date

0612/1017



1. Project Information

Project Name:Fevero LEGACY

Address:3871 E 2200 s

City:Tayor

State:UT

Zip:84404

Latitude:41.2271836

Longitude:-1120697812

UPDES Permit Tracking Number:utr381129

Owner:Bell Built Homes

Contact Person:Cliff Bell

Address:4655 s 1900 w

City:roy

State:ut

Zip:84067

Telephone Number:801-458-1685

Email Address:Contact Person Email

General Contractor:Bell Built Homes

Contact Person:Click here to enter text.

Address:Click here to enter text.

City:Click here to enter text.

State:State

Zip:Zip Code

Telephone Number:Contact Person Phone

Email Address:Contact Person Email

1.5

Unknown Features(although this may be a law under another program, it's not a permit requirement).Discovery of Historical, Archaeological or Paleontological Objects, Features, Sites, or Human Remains

- A. Immediately suspend construction operations in the vicinity(100 foot minimum buffer) of the discovery.
- B. Verbally notify the Public Works Department and provide them the exact location.
- C. Protect the discovery and provide written confirmation of the discovery to the City and State Historic Departments within two calendar days.
- D. Contractor and City follow State mitigation laws.

2. Best Management Practices

{Not all standard control categories listed below are necessary nor are they all inclusive. It is encouraged to only include BMPs for pollution sources that are uncontrolled and apply to the site. Some BMPs may be used to control multiple categories however some categories may require multiple BMPs to control and contain the pollutant sources indicated in the category. Treat each unique BMP option independently because most BMPshave different performance and maintenance requirements. Include a copy of necessary details, instructions or contracts for the BMPs in appendix L} –[Delete blue instruction text, typical all pages -]

2.1 SWPPP Sign(see permit part 1.10, 4.2.11)

Description of construction board is filed in Appendix L

{The construction board shall include but not limited to; NOI, Local permits and SWPPP contacts and shall be in view of the public.}

{See permit part 1.10, 4.2.11 for specific requirements}

2.2 Sensitive Features Control(see permit part 2.2)

{Including but not limited to the standard features below, and wells, UIC's, irrigations ditches, diversion gates, unique vegetation features...}

{Add unique site features as needed}

2.2.x Wetlands

Replace this text with the BMP name or explain why it DOES NOT APPLY.

BMP description, rational for use and specifications, and details are filed in Appendix L. *{Delete this sentence when a BMP is not necessary or replace it with a BMP description when a separate detailed BMP document is not necessary}*

{Add BMPs as Needed}

2.2.x Water Bodies within or 30' from Disturbance Boundary(see permit part 2.3.5)

Replace this text with the BMP name or explain why it DOES NOT APPLY.

BMP description, rational for use and specifications, and details are filed in Appendix L. *{Delete this sentence when a BMP is not necessary or replace it with a BMP description when a separate detailed BMP document is not necessary}*

{Refer to the regulation part 2.3.5 for specific requirements}

{Add BMPs as Needed}

2.3 Sediment Control(see permit part 2.1.2, 2.1.3 & 2.3)

{Including but not limited to the standard controls below}

{Add unique operations or site conditions needing control as needed}

2.3.x Trap/Filter Sediment at Property Boundary(see permit part 2.1.2)

Replace this text with the BMP name or explain why it DOES NOT APPLY.

BMP description, rational for use and specifications, and details are filed in Appendix L. *{Delete this sentence when a BMP is not necessary or replace it with a BMP description when a separate detailed BMP document is not necessary}*

{Generally boundary BMPs are necessary on all sites whether the boundary is controlled by topography, existing vegetation and improvements, or BMPs installed on the site.

Design controls to contain pollutants in the project legal/permit boundary during a significant precipitation or wind storm event. Generally these BMPs are installed at property lines and roadway boundaries. Including but not limited to: swales, berms, waddles, vegetative barriers, silt fence, swale in park-strip and behind sidewalk ("cut-back-curb").

{Add BMPs as Needed}

2.4.x Inlet Protection(see permit part 2.1.3& 2.3)

Replace this text with the BMP name or explain why it DOES NOT APPLY.

BMP description, rational for use and specifications, and details are filed in Appendix L. *{Delete this sentence when a BMP is not necessary or replace it with a BMP description when a separate detailed BMP document is not necessary}*

{Inlet protection is secondary containment usually intended to compensate for the limitations of other BMPs intended to keep sediment off roads, or permitted construction envelope.

Design controls to prevent pollutants from affecting the public and environment that breach the Primary Boundary Controls. BMP shall be designed to prevent flooding in large storm events. These are usually intended to be secondary and a redundant control measure. Including but not limited to: drop inlet bags, inlet waddles, filter fabric, gutter dams

{Add BMPs as Needed}

2.4.x Steep Slopes (see permit part 2.3.2)

Replace this text with the BMP name or explain why it DOES NOT APPLY.

BMP description, rational for use and specifications, and details are filed in Appendix L. *{Delete this sentence when a BMP is not necessary or replace it with a BMP description when a separate detailed BMP document is not necessary}*

{Control the high potential for erosion on steep slopes within the area of influence including beyond the property boundary; see BMP templates in Appendix L}

{Refer to the regulation for specific requirements}

{Repeat as Needed}

2.4.x Street Maintenance(see permit part 3.2.2)

Replace this text with the BMP name or explain why it DOES NOT APPLY.

BMP description, rational for use and specifications, and details are filed in Appendix L. *{Delete this sentence when a BMP is not necessary or replace it with a BMP description when a separate detailed BMP document is not necessary}*

{Sediment removal BMPs should not be expected to be used in place of an inadequate track out BMPs. It is intended to compensate for limitations of good track out BMPs that are employed to the maximum extent practicable. An appropriate track out BMP will minimize the frequency that this BMP will need to be employed.}

Design controls to be in place or ready to mobilize for cleanup or otherwise contain construction materials that breach the other BMPs. Including but not limited to: manual sweeping policy(broom and shovel), removal by mechanical sweeping (washing dirt and sediment with water into a storm drain is a violation of this permit)

{Add BMPs as Needed}

2.4Top Soil Preservation(see permit part 2.5)

Replace this text with the BMP name or explain why it DOES NOT APPLY.

BMP description, rational for use and specifications, and details are filed in Appendix L. *{Delete this sentence when a BMP is not necessary or replace it with a BMP description when a separate detailed BMP document is not necessary}*

{Reuse and or blend topsoil; see BMP templates in Appendix L }

{Add BMPs as Needed}

2.5 Dust Control(see permit part)

{Including but not limited to the standard controls below}

2.5.x

Replace this text with the BMP name or explain why it DOES NOT APPLY.

BMP description, rational for use and specifications, and details are filed in Appendix L. *{Delete this sentence when a BMP is not necessary or replace it with a BMP description when a separate detailed BMP document is not necessary}*

{Generally, dust prevention is necessary for projects with cleared vegetation, and involves excavation and grading.}

Design controls to effectively suppress dust during construction activities and at end of the work day.
Including but not limited to: State Fugitive Dust Plan Requirements, dampen with water, provide a water source, chemical stabilization, selective operation during low wind conditions
{Add BMPs as Needed}

2.6 Egress Control(see permit part 2.4)

2.6.x Track Out(see permit part 2.4.1)

Replace this text with the BMP name or explain why it DOES NOT APPLY.

BMP description, rational for use and specifications, and details are filed in Appendix L. *{Delete this sentence when a BMP is not necessary or replace it with a BMP description when a separate detailed BMP document is not necessary}*

{Generally track out control is necessary for projects that involve machinery moving from non durable ground to pavements. Whether BMPs are a system or policy that will prevent mud from sticking to tires or a BMP that will remove mud or require the manual removal of mud from the vehicle, it is the same. Many sites will benefit from multiple track out BMPs.

Design controls to prevent mud and dirt from being tracked out onto the streets. *Including but not limited to: track out pads, parking pads, access policies, access barriers, cobble, gravel, rubble strips, tire washes, and manual tire cleaning, selective access during dry weather conditions, any structure, system or policy that prevent track out onto the street.*

{Add BMPs as Needed}

2.7 Waste Management Control(see permit part 4.2.6)

{Including but not limited to the standard features below}

{Add unique operations needing control as needed}

2.7.x Solid Waste(see permit part 2.4.3)

Replace this text with the BMP name or explain why it DOES NOT APPLY.

BMP description, rational for use and specifications, and details are filed in Appendix L. *{Delete this sentence when a BMP is not necessary or replace it with a BMP description when a separate detailed BMP document is not necessary}*

{Generally, projects will need solid waste BMPs when any waste can potentially be carried off the site by flowing water, precipitation or wind.

Design controls to prevent construction trash from being be carried off the site by precipitation and wind. Also prevent liquids from spilling onto pavements while onsite and at haul off. *Including but not limited to: dumpsters, covered dumpsters, receptacle w/lids, waste policies, storing waste inside the building, bagging lightweight trash, sloping dumpsters so precipitation will drain on to property and infiltrate, fences*

{Add BMPs as Needed}

2.7.x Construction Spoil(see permit part 2.1.1)

Replace this text with the BMP name or explain why it DOES NOT APPLY.

BMP description, rational for use and specifications, and details are filed in Appendix L. *{Delete this sentence when a BMP is not necessary or replace it with a BMP description when a separate detailed BMP document is not necessary}*

{Generally apply this BMP for project sites storing spoil where the spoil can bury BMPs, erode and reach waterways, track out during transport or blow off the site. Generally containing spoil material can be as simple as locating spoil material behind perimeter controls and controlling track out BMPs during haul off.

Design controls to prevent pollutants associated or created by material spoils storage and removal operations(typically from excavation or site clearing activities). Including but not limited to: covering erodible materials, runoff containment, track out control for spoil removal, haul off policy, operational controls such as not spoiling material near inlets or hard-scape directly connected to drainage system, etc....
{Add BMPs as Needed}

2.7.xSanitary Waste(see permit part 2.4.4)

Replace text with the BMP name or explain why it DOES NOT APPLY.

BMP description, rational for use and specifications, and details are filed in Appendix L. *{Delete this sentence when a BMP is not necessary or replace it with a BMP description when a separate detailed BMP document is not necessary}*

{Generally apply this BMP for project sites storing spoil where the spoil can bury BMPs, erode and reach waterways, track out during transport or blow off the site. Generally containing spoil material can be as simple as locating spoil material behind perimeter controls and controlling track out BMPs during haul off.

Design controls to prevent pollutants associated or created by material spoils storage and removal operations(typically from excavation or site clearing activities). Including but not limited to: covering erodible materials, runoff containment, track out control for spoil removal, haul off policy, operational controls such as not spoiling material near inlets or hard-scape directly connected to drainage system, etc....
{Add BMPs as Needed}

2.7.xCement ProductOperations(see permit part 2.4.5, 2.9.2)

Replace this text with the BMP name or explain why it DOES NOT APPLY.

BMP description, rational for use and specifications, and details are filed in Appendix L. *{Delete this sentence when a BMP is not necessary or replace it with a BMP description when a separate detailed BMP document is not necessary}*

{Generally, apply cement waste control for projects requiring concrete supply trucks, concrete truck chassis, pump truck hopper, mortar hopper, miscellaneous hand tools, and other large concrete operations or operations that involve high PH materials

Design BMPs to contain concrete waste, and other related waste, on the site from runoff and leaching. Including but not limited to: onsite depression, lined depressions, steel bins, waste disposal policies, signage directing supplies where to dump, directions for washing concrete truck chassis
{Add BMPs as Needed}

2.7.xConcrete Cutting Operations(see permit part 2.9.2)

Replace this text with the BMP name or explain why it DOES NOT APPLY.

BMP description, rational for use and specifications, and details are filed in Appendix L. *{Delete this sentence when a BMP is not necessary or replace it with a BMP description when a separate detailed BMP document is not necessary}*

{Generally, concrete cutting operations BMPs are necessary where the coolant waste and cutting dust can reach waterways or affect adjacent properties.

Design BMPs to prevent pollutants from entering storm drain inlets. Contain cutting coolant and removal of dry cuttings prior wet or windy conditions. Including but not limited to: temporary dams, cleanup procedures, filters(BMPs that allow a discharge must be accompanied by a wastewater discharge permit, UTG070000), etc
{Add BMPs as Needed}

2.7.xNon Aqueous Waste(see permit part 2.8.2)

Replace this text with the BMP name or explain why it DOES NOT APPLY.

BMP description, rational for use and specifications, and details are filed in Appendix L. *{Delete this sentence when a BMP is not necessary or replace it with a BMP description when a separate detailed BMP document is not necessary}*

{Generally, this applies to projects generating liquid construction waste material such as but not limited to paint, solvents, stucco, dyes, etc.}

Design BMPs to contain concrete waste, and other related waste, on the site from runoff and leaching.

Including but not limited to: onsite depression, lined depressions, steel bins, waste disposal policies, signage directing supplies where to dump

{Add BMPs as Needed}

2.7.x Construction Wastewater*(see permit part 2.7, 2.9, 2.9.4)*

Replace this text with the BMP name or explain why it DOES NOT APPLY.

BMP description, rational for use and specifications, and details are filed in Appendix L. *{Delete this sentence when a BMP is not necessary or replace it with a BMP description when a separate detailed BMP document is not necessary}*

{Generally apply this BMP for project sites that anticipate high water table or when stormwater or other water sources will need to be discharged or pumped away from a construction zone.}

Design controls to prevent the disposal of polluted construction wastewater that encumbers the site.

Including but not limited to: file required state permit for disposal, filter discharges, discharge onsite in containment/retention area. Any direct discharges requires State Permit UTG070000 be attached in appendix. {Add BMPs as Needed}

2.8 Management of Construction Materials Control

{Including but not limited to the standard features below}

{Add unique site operations needing control as needed}

2.8.x Storage of Construction Materials*(see permit part 2.8.2)*

Replace this text with the BMP name or explain why it DOES NOT APPLY.

BMP description, rational for use and specifications, and details are filed in Appendix L. *{Delete this sentence when a BMP is not necessary or replace it with a BMP description when a separate detailed BMP document is not necessary}*

{Generally apply this BMP for project sites that involve the delivery and storage of materials that if are exposed to the weather can cause harm to the soil or pass through boundary controls. Usually these are exposed liquids or chemicals that can be cause harm if exposed or spilled.}

Design controls to prevent pollutants associated with storage materials. *Including but not limited to: covering erodible or liquid materials, secondary containment, storing where pavement is not directly connected to waterways. Locate where track out will be minimized when using or the delivery of these construction materials.*

{Add BMPs as Needed}

2.8.x Construction Staging(backfill)*(see permit part 2.1.1)*

Replace this text with the BMP name or explain why it DOES NOT APPLY.

BMP description, rational for use and specifications, and details are filed in Appendix L. *{Delete this sentence when a BMP is not necessary or replace it with a BMP description when a separate detailed BMP document is not necessary}*

{Generally apply this BMP for project sites involving staging operations of erodible materials where the materials themselves can erode by wind or water and reach waterways or where track out from the operation can be an issue. It could be necessary to include BMPs for multiple construction operations including but not limited to: plumbing utilities, utility companies, grading, etc.

Design controls prevent pollutants associated or created by material staging operations.

Including but not limited to: Covering or surrounding backfill, operational(remove backfill from pavements prior to wet conditions or before end of day whichever comes first), strategic staging locations that will prevent material from reaching waterways, provide staging area near track out BMPs, locate staging area behind perimeter BMPs, etc.

{Add BMPs as Needed}

2.8.x Construction Staging(Landscaping)*(see permit part 2.1.1)*

Replace this text with the BMP name or explain why it DOES NOT APPLY.

BMP description, rational for use and specifications, and details are filed in Appendix L. *{Delete this sentence when a BMP is not necessary or replace it with a BMP description when a separate detailed BMP document is not necessary}*

{Generally apply this BMP for project sites involving staging operations of erodible materials where the materials themselves can erode by wind or water and reach waterways or where track out from the operation can be an issue. It could be necessary to include BMPs for multiple construction operations

Design controls prevent pollutants associated or created by material staging operations.

Including but not limited to: Covering or surrounding backfill, operational(remove backfill from pavements prior to wet conditions or before end of day whichever comes first), strategic staging locations that will prevent material from reaching waterways, provide staging area near track out BMPs, locate staging area behind perimeter BMPs, etc.

{Add BMPs as Needed}

2.9 Final Stabilization*(see permit part 2.6)*

{Including but not limited to the standard features below}

2.9.x Landscaping Plan

Replace this text with reference to the landscape plan in appendix B or explain why it DOES NOT APPLY

{stabilize the disturbed ground; Put final landscaping plan in Appendix B}

{Final Landscaping features when landscaped by the Operator}

{Refer to the regulation for specific requirements}

{Add BMPs as Needed}

2.9.x Temporary Containment of Sediment

Replace this text with the BMP name or explain why it DOES NOT APPLY.

BMP description, rational for use and specifications, and details are filed in Appendix L. *{Delete this sentence when a BMP is not necessary or replace it with a BMP description when a separate detailed BMP document is not necessary}*

{Generally projects that include mature landscaping improvements will satisfy this requirement by those improvements themselves, however projects not including complete mature landscaping improvements will need temporary BMPs to contain erosion until 70% is achieved.

These controls must contain sediments and other pollutants until the new property is stabilized. This BMP is for after the project is completed but before the site has 70% vegetative cover. These controls must be such that if left unmaintained will not become the source of pollutants. Including but not limited to: landscaping (installation of vegetation), swales, leave front-yard lower than sidewalk, rock filters, native vegetative barriers...

{Add BMPs as Needed}

3. Spill Prevention and Response Plan (see permit part 2.8.3, 2.9.3)

Describe the spill prevention and control plan to include ways to reduce the chance of spills, stop the source of spills, contain and cleanup spills, dispose of materials contaminated by spills, and train personnel responsible for spill prevention and control. Additionally, fill in all **BLUE** fields below. {The primary purpose of spill control is to contain spills before causing damage and secondary the proper clean up and disposal.

Spill controls must contain spills, and be mobilized at the moment of need. The plan must include the materials and method of containment and for flowing liquid, cleanup and disposal and follow the minimum spill controls below. Including but not limited to: existing company spill policy, standard operation procedures, onsite containment BMPs, containment materials/spill kit, absorbent products, dirt, sand, absorbent/oil dry, sealable containers, plastic bags, shovels and brooms etc.

Description of Spill control Plan, details and policy are filed in Appendix L.

Any discharges in 24 hours equal to or in excess of the reportable quantities listed in 40 CFR 117, 40 CFR 110, and 40 CFR 302 will be reported to the National Response Center and the Division of Water Quality (DWQ) as soon as practical after knowledge of the spill is known to the permittee. The permittee shall submit within 14 calendar days of knowledge of the release a written description of: the release (including the type and estimate of the amount of material released), the date that such release occurred, the circumstances leading to the release, and measures taken and/or planned to be taken to the Division of Water Quality (DWQ), 288 North 1460 West, P.O. Box 144870, Salt Lake City, Utah 84114-4870. The Storm Water Pollution Prevention Plan must be modified within 14 calendar days of knowledge of the release to provide a description of the release, the circumstances leading to the release, and the date of the release. In addition, the plan must be reviewed to identify measures to prevent the reoccurrence of such releases and to respond to such releases, and the plan must be modified where appropriate.

Agency	Phone Number
National Response Center	(800) 424-8802
Division of Water Quality (DWQ) 24-Hr Reporting	(801) 538-6146; (801) 536-4123
Utah Department of Health Emergency Response	(801) 580-6681
Weber Fire Department	(801)745-9277 or (801)782-3580

Minimum spill quantities requiring reporting:

Material	Media Released To	Reportable Quantity
Engine oil, fuel, hydraulic & brake fluid	Land	25 gallons
Paints, solvents, thinners	Land	100 lbs (13 gallons)
Engine oil, fuel, hydraulic & brake fluid	Water	Visible Sheen
Refrigerant	Air	1 lb
Antifreeze, battery acid, gasoline, engine degreasers	Air, Land, Water	100 lbs (13 gallons)

Emphasis to:

- 1st Priority: Protect all people (including onsite staff)
- 2nd Priority: Protect equipment and property
- 3rd Priority: Protect the environment

1. Make sure the spill area is safe to enter and that it does not pose an immediate threat to health or safety of any person.
2. Check for hazards (flammable material, noxious fumes, cause of spill) – if flammable liquid, turn off engines and nearby electrical equipment. If serious hazards are present leave area and call 911. LARGE SPILLS ARE LIKELY TO PRESENT A HAZARD.
3. Stop the spill source and contain flowing spills immediately with spill kits, dirt or other material that will achieve containment.
4. Call co-workers and supervisor for assistance and to make them aware of the spill and potential dangers
5. If spilled material has entered a storm sewer, regardless of containment; contact the Municipal Storm Water Division.
6. Cleanup all spills (flowing or non-flowing) immediately following containment. Clean up spilled material according to manufacturer specifications, for liquid spills use absorbent materials AND DO NOT FLUSH AREA WITH WATER.
7. Properly dispose of cleaning materials and used absorbent material according to manufacturer specifications.
8. Report the reportable quantity to the Weber Morgan Health Department.

Emergency Numbers

Utah Hazmat Response Officer 24 hrs	(801)-538-3745
Weber County Sheriff Department	(801)-778-6600)
Weber County Engineering Division	(801)-399-8374

4. Site Map(s)*(see permit part 4.2.3)*

The SWPPP site maps are filed in Appendix B

{Maps shall include all structural BMPs, and all site components necessary to demonstrate pollution containment. Multiple SWPPP site map sheets may be necessary to clearly show how and when BMPs are to be employed relative to the construction phases}

The SWPPP site maps shall include but not limited to:

- 1. boundaries of project/property*
- 2. boundaries of disturbance (including areas outside of property boundaries)*
- 3. show slopes on site*
- 4. location of structures/facilities*
- 5. locations of :*
 - a. stockpiles for soils and materials*
 - b. construction supplies*
 - c. portable toilets*
 - d. garbage/trash containers*
 - e. egress points/track out pads*
 - f. concrete washout pits or containers*
- 6. water bodies, wetlands, natural vegetative buffers*
- 7. placement of all BMPs, perimeter, erosion control, sediment control, inlet, etc.*
- 8. storm water inlets and storm water discharge points (where storm water drains off the site)*
- 9. areas that will be temporarily or permanently stabilized on the site*

{Refer to the regulation for specific requirements}

5. Record Keeping

See the appendices in Appendix A-K.

{In the Appendix there are report and log forms for all the necessary recordkeeping. The record keeping is literally demonstrating to the EPA, DWQ and MS4 that the site is in compliance. A compliant site requires effective and maintained BMP and accurate SWPPP documentation.

SWPPP Inspections-Maintenance-Correction Report(permit part 3.2.1, 3.2.2,3.3,3.4, 4.2.12)

Inspections are required every 7 calendar days

Repair or replace BMPs prior to need or by end of week whichever comes first. Update the Inspection-Maintenance-Correction Report weekly.

Section 3.2.2 requires daily maintenance of pavements and site grounds.

See the Inspection-Maintenance-Correction Reports in Appendix E

{There is an Inspection-Maintenance-Correction Report template provided in EXHIBIT E of this SWPPP template. File all Inspection-Maintenance-Correction reports there.}

Changes to the SWPPP(see permit part 4.2.12, 4.2.13)

See the Amendment Log in Appendix F.

{There is a SWPPP Amendment log template provided in EXHIBIT F of this SWPPP template. Record SWPPP changes there.}

Training(see permit part 4.2.7)

Training Logs and Documents are filed in Appendix H.

{Owner/Operator is required to train all parties involved in the project, including but not limited to: company staff, sub contractors, suppliers, servicing utilities...}

6. Discharge Information

Receiving Waters (look up <http://wq.deq.utah.gov> to identify your receiving water body)

1. Open Drain ditches that go to weber river then to ogden bay then Great Salt Lake

Impaired Waters (refer to <http://wq.deq.utah.gov> in the left hand column to determine status of receiving water body).

Impaired Surface Water	Is this surface water impaired?	Pollutant(s) causing the impairment	Has a TMDL been completed?	Pollutant(s) for which there is a TMDL
Water Body Name	<input type="checkbox"/> Yes <input checked="" type="checkbox"/> No	See web site above	<input type="checkbox"/> Yes <input type="checkbox"/> No	See web site above

Copy the table above and repeat where there is more than one water body.

7. Certification, Notification and Delegation(see permit part 4.2.9)

Owner Certification: See documents filed in Appendix G.

Operator Certification: See documents filed in Appendix G. Not necessary when the Owner and Operator are the same.

Delegation of Authority: insert text here If used include documents and reference their file in Appendix G.

Subcontractor Certification: insert text here If used include documents and reference their file in Appendix G.

Notice of Permit Transfer Requirements: insert text here If used include documents and reference their file in Appendix G.

{There are forms for these actions provided in EXHIBIT G of this SWPPP template. File all certification and delegation documents there.}

APPENDIX F: SWPPP Amendment Log

OPERATOR CERTIFICATION

I certify under penalty of law that this document and all attachments were prepared under my direction or supervision in accordance with a system designed to assure that qualified personnel properly gathered and evaluated the information submitted. Based on my inquiry of the person or persons who manage the system, or those persons directly responsible for gathering the information, the information submitted is, to the best of my knowledge and belief, true, accurate, and complete. I am aware that there are significant penalties for submitting false information, including the possibility of fine and imprisonment for knowing violations.

Name: CLIFF BELL Title: 801-458-7685

Signature:  Date: _____

Company: Lot 102 FAVARD LEG

Project: BELL BUILT HARNER

SUBCONTRACTOR CERTIFICATION
STORMWATER POLLUTION PREVENTION PLAN

Project Number: _____

Project Title: _____

Operator(s): _____

As a subcontractor, you are required to comply with the Stormwater Pollution Prevention Plan (SWPPP) for any work that you perform on-site. Any person or group who violates any condition of the SWPPP may be subject to substantial penalties or loss of contract. You are encouraged to advise each of your employees working on this project of the requirements of the SWPPP. A copy of the SWPPP is available for your review at the office trailer.

Each subcontractor engaged in activities at the construction site that could impact stormwater must be identified and sign the following certification statement:

I certify under the penalty of law that I have read and understand the terms and conditions of the SWPPP for the above designated project and agree to follow the BMPs and practices described in the SWPPP.

This certification is hereby signed in reference to the above named project:

Company: _____

Address: _____

Telephone Number: _____

Type of construction service to be provided: _____

Signature: _____

Title: _____

Date: _____

Delegation of Authority Form

Delegation of Authority

I, _____ (name), hereby designate the person or specifically described position below to be a duly authorized representative for the purpose of overseeing compliance with environmental requirements, including the Construction General Permit, at the _____ construction site. The designee is authorized to sign any reports, stormwater pollution prevention plans and all other documents required by the permit.

_____ (name of person or position)
_____ (company)
_____ (address)
_____ (city, state, zip)
_____ (phone)

By signing this authorization, I confirm that I meet the requirements to make such a designation as set forth in _____ (Reference State Permit), and that the designee above meets the definition of a “duly authorized representative” as set forth in _____ (Reference State Permit).

I certify under penalty of law that this document and all attachments were prepared under my direction or supervision in accordance with a system designed to assure that qualified personnel properly gathered and evaluated the information submitted. Based on my inquiry of the person or persons who manage the system, or those persons directly responsible for gathering the information, the information submitted is, to the best of my knowledge and belief, true, accurate, and complete. I am aware that there are significant penalties for submitting false information, including the possibility of fine and imprisonment for knowing violations.

Name: _____

Company: _____

Title: _____

Signature: _____

Date: _____

Notice of Permit Transfer Requirements

Upon transfer of ownership or control of the subject property under this Permit (see section 8.2.2.a.) coverage under the UPDES CGP must continue until stabilization requirements are satisfied according to permit requirements. This requirement may be met by either of the following transfer options:

1. Obtaining coverage under a new and independent Notice of Intent (NOI – the application process to procure coverage under the UPDES CGP). This results in a new permit coverage number.
 2. Coordinating with the previous owners and the State of Utah, Department of Environmental Quality, Division of Water Quality where ownership, other information, and signatures (including electronic certifications) contained in the NOI that is current for the property is changed to reflect the change in ownership and responsible parties for conducting construction activities (general contractor). For this step you would assume the responsibilities of the original CGP coverage. This continues the original permit coverage number.
-

Name of Previous Owner Telephone Number

Address of Previous Owner City State Zip

Signature of Previous Owner Date

Name of New Owner Telephone Number

Address of New Owner City State Zip

Signature of New Owner Date

PROJECT NAME AND LOCATION

Previous Permit Number Name of Project

Address of Project	City	State	Zip
--------------------	------	-------	-----

Longitude	Latitude
-----------	----------

WHAT KIND OF TRANSFER: PARTIAL OR TOTAL?

Is this a transfer of ownership of partial or total of the permitted area? Partial
Total

If this is a transfer of part of the permitted area to a new owner, describe what part:

Will there be a new SWPPP prepared? YES NO

Please update the General Contractor Information (see transfer options 1 or 2, first page). If this is a partial transfer the only option is 1.

This form must be submitted to the Municipality of Jurisdiction and DWQ

To submit to DWQ either email to the construction storm water coordinator or,
FAX to 801-535-4301

Or mail to DWQ
PO Box 144870

APPENDIX H: Training Log

Training Log				
Training Date	Name and Title of Trainer	Name of person(s) and Company(s) Trained	BMP(s) Pertaining	Description of training material e.g. instruction, direction, etc. Attach all support documents in Appendix J. Including but not limited to: certifications, contracts, videos, literature, meeting minutes, memos, letters, emails, phone logs...

Stormwater Pollution Prevention Plan(SWPPP) 2016-07-28
Residential Common Plan

WEEKLY INSPECTION- MAINTENANCE-CORRECTION REPORT <small>(permit part 3.2.1, 3.2.2, 3.3, 3.4)</small>					
INSPECTION PERIOD:			SITE NAME:		
INSPECTOR:			RAIN EVENTS:		
			CURRENT WEATHER:		
BMP	INSPECTION DATE	OK/NOT OK?	BMP CONDITION	CORRECTION DATE	CORRECTION ACTIONS TAKEN
Are all pollution sources controlled? Do any other problems exist?					
List all SWPPP BMPs					

*DAILY MAINTENANCE- Section 3.2.2 requires daily removal of dirt from pavements and the removal of loose light weight trash. This is separate from maintenance and correction requirements resulting from the weekly inspections. It is encouraged but not required to include other regular maintenance actions demonstrating the site is regularly maintained. This may help avoid additional maintenance requirements from the City inspector.

BMP OR SITE FEATURE MAINTAINED DURING THE REPORT WEEK	DAY / DATE	BMP CONDITION \ SITE CONDITION	MAINTENANCE PERFORMED

I certify under penalty of law that this document and all attachments were prepared under my direction or supervision in accordance with a system designed to assure that qualified personnel properly gathered and evaluated the information submitted. Based on my inquiry of the person or persons who manage the system, or those persons directly responsible for gathering the information, the information submitted is, to the best of my knowledge and belief true, accurate, and complete. I am aware that there are significant penalties for submitting false information, including the possibility of fine and imprisonment for knowing violations.

Name: _____ Title: _____
Signature: _____ Date: _____

SWPPP AMENDMENT LOG			
Amendment #	Description of the Amendment	Date of Amendment	Notes

A-

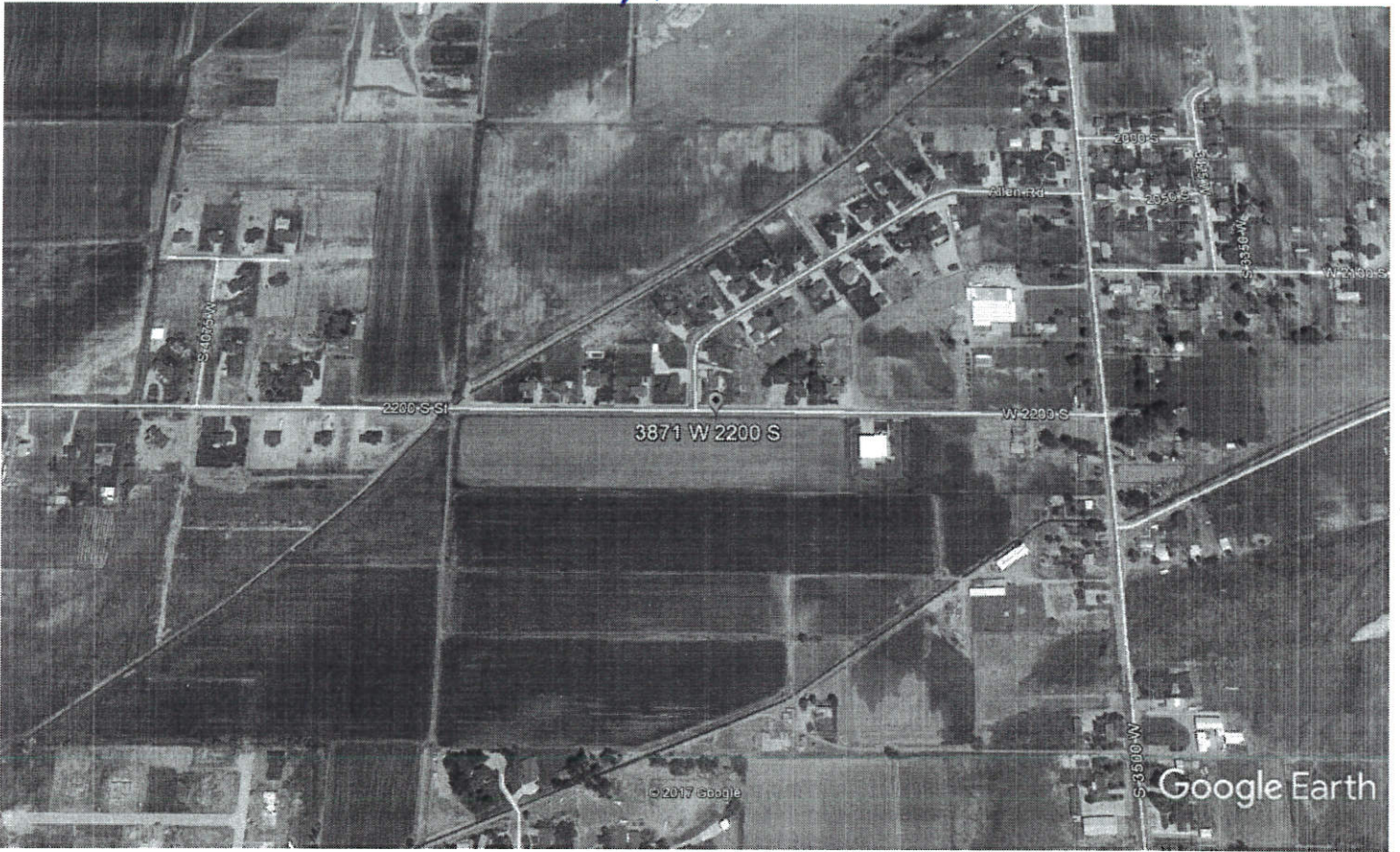

Google Earth



App - C
Print This off

General Permit for Storm Water Discharges from Construction Activities
STATE OF UTAH, DEPARTMENT OF ENVIRONMENTAL QUALITY,
DIVISION OF WATER QUALITY

General Storm Water Permit for Construction Activity
Connected with Single Lot Housing Projects
Utah Pollution Discharge Elimination System Permit No. UTRH00000
(Common Plan Permit)

This Permit is issued in compliance with the provisions of the Utah Water Quality Act (Utah Code Annotated 19-5, as amended) the federal Water Pollution Control Act (33 United States 1251 et. seq., as amended by the Water Quality Act of 1987, Public Law 100-4), and the rules and Regulations made pursuant to those statutes.

This permit applies to "construction activity" for a single lot disturbing a total of one acre or less and for construction activities related to residential dwellings. A single lot covered by this permit is part of a common plan of development or sale (see definitions in Part 6).

Issuance of this permit does not authorize any permittee to violate water quality standards. The permittee shall develop best management practices (BMPs) and engage in activities that will protect water quality during the construction project.

This permit shall become effective on February 1, 2016.

This permit and the authorization to discharge expire at midnight on January 31, 2021.

Signed this 20 day of January, 2016

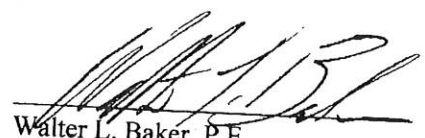
Walter L. Baker, P.E.
Director



DWQ-2016-002081 *JS*

BMP.

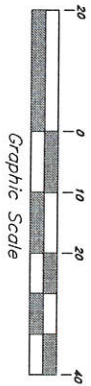
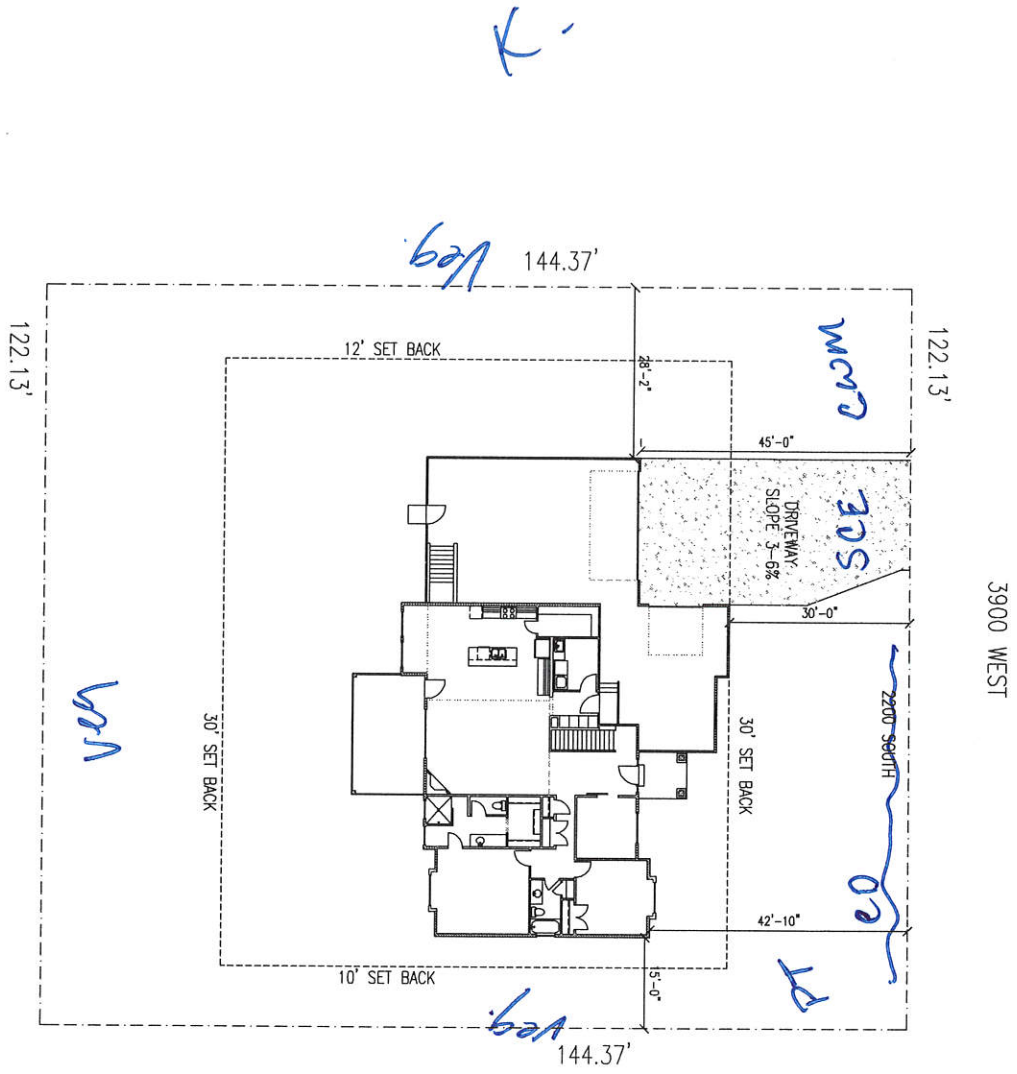

Scale: 1" = 20'



OPHEIKENS RESIDENCE
 LOT 102 FAVERO LEGACY SUBDIVISION
 2200 SOUTH 3900 WEST
 TAYLOR, UTAH



LAKMAN HOME DESIGNS
 TIM LAKMAN
 (801)-205-0382

BELL BUILT HOMES
 CLIFF BELL
 ROY, UTAH
 (801) 458-1685

ST 1

SHEET

DATE: 06-01-17

SCALE: 1/8" = 1'-0"

JOB: OPHEIKENS

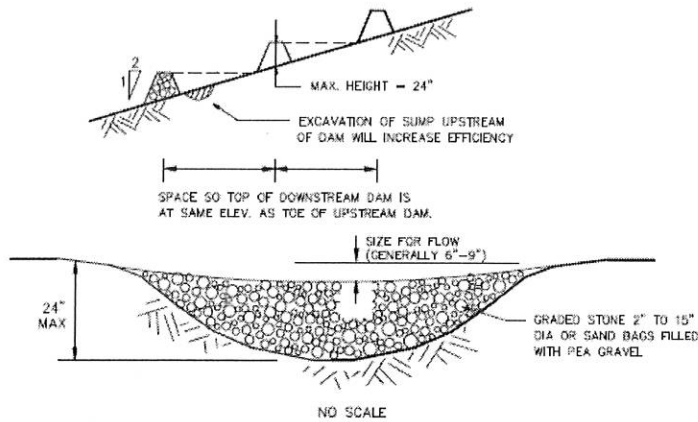

DESCRIPTION:

A small, temporary dam constructed across a drainage ditch to reduce velocity of concentrated storm water flows, thereby reducing the erosion of the ditch.

APPLICATION:

- ▶ Temporary drainage paths
- ▶ Permanent drainage ways not yet stabilized
- ▶ Existing drainage paths receiving increased flows due to construction

INSTALLATION/APPLICATION CRITERIA:

- ▶ Prepare location of dam by removing any debris and rough grading any irregularities in channel bottom
- ▶ Place rocks by hand or with appropriate machinery, do not dump
- ▶ Construct dam with center lower to pass design flow
- ▶ Construct 50% side slopes on dam

LIMITATIONS:

- ▶ Maximum recommended drainage area is 10 acres
- ▶ Maximum recommended height is 24"
- ▶ Do not use in running stream

MAINTENANCE:

- ▶ Inspect dams daily during prolonged rainfall, after each major rain event and at a minimum of once monthly.
- ▶ Remove any large debris and repair any damage to dam, channel or sideslopes
- ▶ Remove accumulated sediment when it reaches one half the height of the dam

OBJECTIVES

- Housekeeping Practices
- Contain Waste
- Minimize Disturbed Areas
- Stabilize Disturbed Areas
- Protect Slopes/Channels
- Control Site Perimeter
- Control Internal Erosion



WEBER COUNTY

ENGINEERING DEPARTMENT

2380 Washington Blvd., Suite 240
Ogden, UT 84401
(801) 399-8374

TARGETED POLLUTANTS

- Sediment
- Nutrients
- Toxic Materials
- Oil & Grease
- Floatable Materials
- Other Waste

- High Impact
- Medium Impact
- Low or Unknown Impact

IMPLEMENTATION REQUIREMENTS

- Capital Costs
- O&M Costs
- Maintenance
- Training

- High
- Medium
- Low

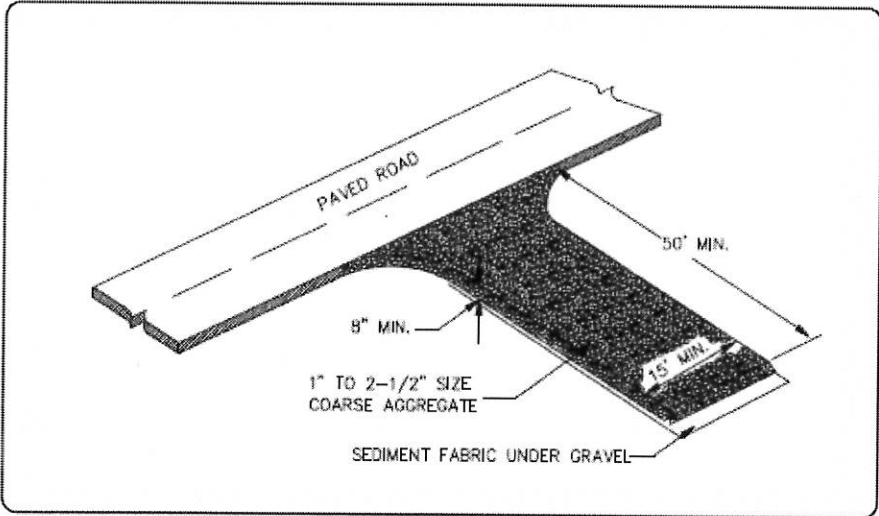

- ### OBJECTIVES
- Housekeeping Practices
 - Contain Waste
 - Minimize Disturbed Areas
 - Stabilize Disturbed Areas
 - Protect Slopes/Channels
 - Control Site Perimeter
 - Control Internal Erosion



WEBER COUNTY

ENGINEERING DEPARTMENT
 2380 Washington Blvd., Suite 240
 Ogden, UT 84401
 (801) 399-8374

DESCRIPTION:

A stabilized pad of crushed stone located where construction traffic enters or leaves the site from or to paved surface.

APPLICATIONS:

- ▶ At any point of ingress or egress at a construction site where adjacent traveled way is paved. Generally applies to sites over 2 acres unless special conditions exist.

INSTALLATION/APPLICATION CRITERIA:

- ▶ Clear and grub area and grade to provide maximum slope of 2%.
- ▶ Compact subgrade and place filter fabric if desired (recommended for entrances to remain for more than 3 months).
- ▶ Place coarse aggregate, 1 to 2-1/2 inches in size, to a minimum depth of 8 inches.

LIMITATIONS:

- ▶ Requires periodic top dressing with additional stones.
- ▶ Should be used in conjunction with street sweeping on adjacent public right-of-way.

MAINTENANCE:

- ▶ Inspect daily for loss of gravel or sediment buildup.
- ▶ Inspect adjacent roadway for sediment deposit and clean by sweeping or shoveling.
- ▶ Repair entrance and replace gravel as required to maintain control in good working condition.
- ▶ Expand stabilized area as required to accommodate traffic and prevent erosion at driveways.

- ### TARGETED POLLUTANTS
- Sediment
 - Nutrients
 - Toxic Materials
 - Oil & Grease
 - Floatable Materials
 - Other Waste
-
- High Impact
 - Medium Impact
 - Low or Unknown Impact

- ### IMPLEMENTATION REQUIREMENTS
- Capital Costs
 - O&M Costs
 - Maintenance
 - Training
-
- High
 - Medium
 - Low

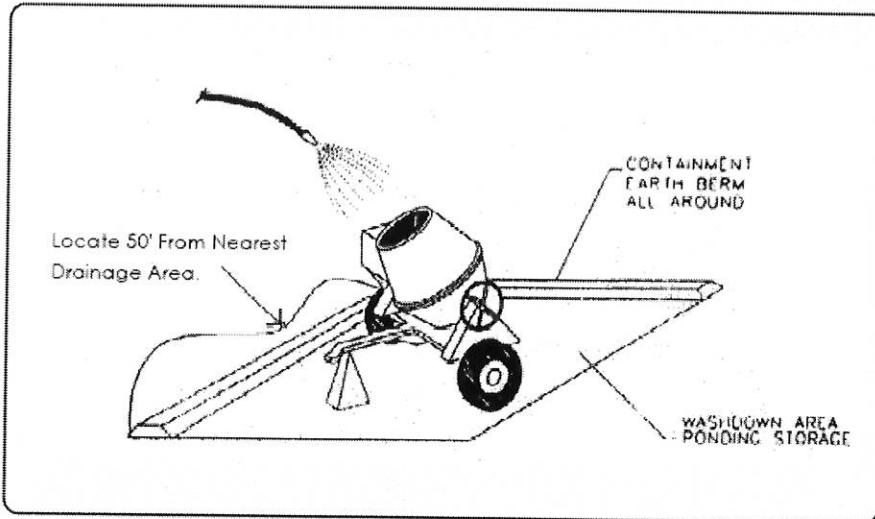

OBJECTIVES

- Housekeeping Practices
- Contain Waste
- Minimize Disturbed Areas
- Stabilize Disturbed Areas
- Protect Slopes/Channels
- Control Site Perimeter
- Control Internal Erosion

DESCRIPTION:

Prevent or reduce the discharge of pollutants to storm water from concrete waste by conducting washout off-site, performing on-site washout in a designated area, and training employees and subcontractors.

APPLICATIONS:

- ▶ This technique is applicable to all types of sites.

INSTALLATION/APPLICATION CRITERIA:

- ▶ Store dry and wet materials under cover, away from drainage areas.
- ▶ Avoid mixing excess amounts of fresh concrete or cement on-site.
- ▶ Perform washout of concrete trucks off-site or in designated areas only.
- ▶ Do not wash out concrete trucks into storm drains, open ditches, streets, or streams.
- ▶ Do not allow excess concrete to be dumped on-site, except in designated areas.
- ▶ When washing concrete to remove fine particles and expose the aggregate, avoid creating runoff by draining the water within a bermed or level area. (See Earth Berm Barrier information sheet.)
- ▶ Train employees and subcontractors in proper concrete waste management.

LIMITATIONS:

- ▶ Off-site washout of concrete wastes may not always be possible.

MAINTENANCE:

- ▶ Inspect subcontractors to ensure that concrete wastes are being properly managed.
- ▶ If using a temporary pit, dispose hardened concrete on a regular basis.



WEBER COUNTY

ENGINEERING DEPARTMENT

2380 Washington Blvd., Suite 240
Ogden, UT 84401
(801) 399-8374

TARGETED POLLUTANTS

- Sediment
- Nutrients
- Toxic Materials
- Oil & Grease
- Floatable Materials
- Other Construction Waste

- High Impact
- Medium Impact
- Low or Unknown Impact

IMPLEMENTATION REQUIREMENTS

- Capital Costs
- O&M Costs
- Maintenance
- Training

- High
- Medium
- Low

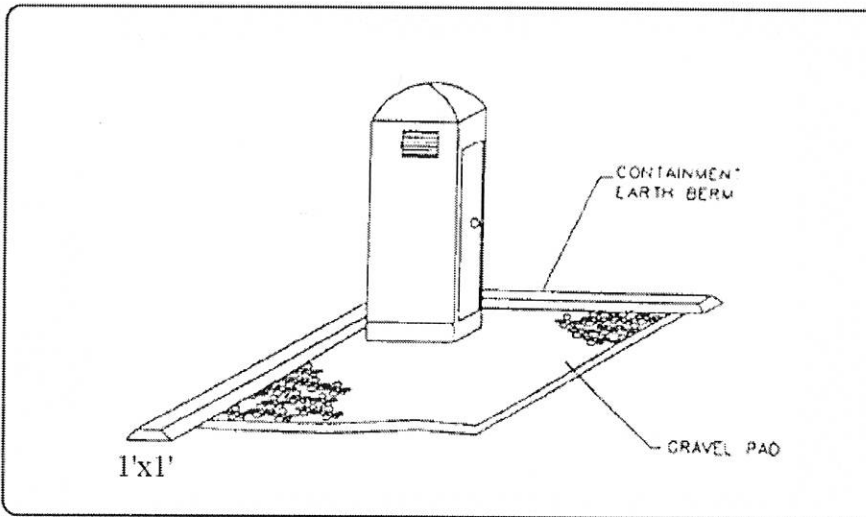

DESCRIPTION:

Temporary on-site sanitary facilities for construction personnel.

APPLICATION:

- ▶ All sites with no permanent sanitary facilities or where permanent facility is too far from activities.

INSTALLATION/APPLICATION CRITERIA:

- ▶ Locate portable toilets in convenient locations throughout the site.
- ▶ Prepare level, gravel surface and provide clear access to the toilets for servicing and for on-site personnel.
- ▶ Construct earth berm perimeter (See Earth Berm Barrier Information Sheet), control for spill/protection leak.

LIMITATIONS:

No limitations.

MAINTENANCE:

- ▶ Portable toilets should be maintained in good working order by licensed service with daily observation for leak detection.
- ▶ Regular waste collection should be arranged with licensed service.
- ▶ All waste should be deposited in sanitary sewer system for treatment with appropriate agency approval.

OBJECTIVES

- Housekeeping Practices
- Contain Waste
- Minimize Disturbed Areas
- Stabilize Disturbed Areas
- Protect Slopes/Channels
- Control Site Perimeter
- Control Internal Erosion



WEBER COUNTY

ENGINEERING DEPARTMENT

2380 Washington Blvd., Suite 240
Ogden, UT 84401
(801) 399-8374

TARGETED POLLUTANTS

- Sediment
- Nutrients
- Toxic Materials
- Oil & Grease
- Floatable Materials
- Other Construction Waste

- High Impact
- Medium Impact
- Low or Unknown Impact

IMPLEMENTATION REQUIREMENTS

- Capital Costs
- O&M Costs
- Maintenance
- Training

- High
- Medium
- Low