



1497 West 40 South
Lindon, Utah - 84042
Phone (801) 225-5711

3662 West 2100 South
Salt Lake City, Utah - 84120
Phone (801) 787-9138

1596 W. 2650 S. #108
Ogden, Utah - 84401
Phone (801) 399-9516

January 29, 2016

Mr. Martin Nobs
50 River Bluff Road
Elgin, IL 60120

**Re: Rock Retaining Wall Design
Lot 15 Ski Lake Estates No. 3
6640 East 1100 South
Huntsville, Utah
Job No. 145150G**

Gentlemen:

As you requested, we have completed our rock retaining wall design and slope stability analysis for the residence located on Lot 15 in the Ski Lake Estates in Huntsville, Utah. Earthtec Engineering has completed a geotechnical report¹, and addendum² to the subject site.

Proposed Construction

A representative of Earthtec Engineering visited the site on January 9, 2016 to observe the proposed rock wall location and surrounding lot's existing geometry and soils conditions. We understand that a 2 to 7 foot rock wall will be constructed to retain a slope between the roadway and proposed driveway. The approximate retaining wall location is shown on Figure No. 1, *Aerial Photograph Showing Location of Retaining Wall and Slope Cross-Sections*.

Cross-Section A-A' starts in the building pad of the proposed residence and is relatively flat for approximately 35 feet to the base of the proposed rock retaining wall. The single tier wall at the maximum height will be 7 feet in exposed height. From the top of the rock wall there will be a slope up to the existing roadway.

Stability Analyses

Our engineering analyses focused on evaluating the stability of the proposed rock retaining wall. Based on our visual observations of the site from our hand excavated test hole and previous subsurface investigations, the natural soils at the site appear to consist of topsoil overlying lean clay (CL), silty sand (SM), and sandstone. The properties of the soils observed at the wall location were estimated our laboratory direct shear test for the clay and sand, and by referenced laboratory testing. Our direct shear³ results for the silty sand soil has an internal friction angle of 34 degrees and cohesion of 240 pounds per square foot. Our direct shear⁴ results for the clay soil has an internal friction angle of 21 degrees and cohesion of 345 pounds per square foot. The referenced laboratory testing by the Bureau of Reclamation⁵ estimates silty sand has an internal friction angle between than 33 and 35 degrees and cohesion between 280 and 560 pounds per square foot and clay has an internal friction angle between than 26 and 30 degrees and cohesion between 240 and 320 pounds per square foot. Accordingly, we estimated the following parameters for use in the stability analyses:

¹ "Geotechnical Study, Lot 15 Ski Lake Estates No. 3, 6640 East 1100 South, Huntsville, Utah", EE Project No. 145150G, June 23, 2014.

² "Addendum I to Geotechnical Study, Lot 15 Ski Lake Estates No. 3, 6640 East 1100 South, Huntsville, Utah", EE Project No. 145150G, July 13, 2015.

³ See Figure No. 2

⁴ See Figure No. 3

⁵ US Bureau of Reclamation, 1987, "Design Standards No. 13, Embankment Dams, Denver Colorado"

Earthtec Engineering

Material	Internal Friction Angle (degrees)	Apparent Cohesion (psf)	Moist Unit Weight (pcf)	Saturated Unit Weight (pcf)
Silty SAND (SM)	34	240	100	134
Lean CLAY (CL)	20	200	113	130
Cobble or Gravel Fill	34	0	135	135
Retaining Wall	0 (or 45)	1000 (or 0)	145	145

For the seismic (pseudostatic) analysis, a peak horizontal ground acceleration of 0.3854g for the 2% probability of exceedance in 50 years was obtained for site (grid) locations of 41.247 degrees north latitude and -111.788 degrees west longitude. Typically, one-third to one-half this value is utilized in analysis. Accordingly, a value of 0.193 was used as the pseudostatic coefficient for the stability analysis.

Using these input parameters, the internal (rock-to-rock) stability of the wall was evaluated considering sliding, overturning, and bearing capacity to achieve respective minimum factors of safety of 1.5, 2.0 and 2.0 for static conditions and 1.1, 1.5 and 1.5 for seismic conditions. The backcut angle was assumed to be slightly flatter than 1H:2V (Horizontal:Vertical), because of the location of the rock wall and the existing slope. The results of this analysis (see Figure No. 4, *Rock Wall Stability Evaluation*) indicate that a single tier maximum exposed height of about of 7 feet can be achieved using boulder sizes ranging from 48 inches (bottom row) to 24 inches (top row).

We evaluated the global stability surrounding the proposed rock retain wall using the computer program XSTABL. This program uses a limit equilibrium (Bishop's modified) method for calculating factors of safety against sliding on an assumed failure surface and evaluates numerous potential failure surfaces, with the most critical failure surface identified as the one yielding the lowest factor of safety of those evaluated. A water table was conservatively placed at approximately at 10 feet below the ground surface, although groundwater was not encountered during any of field explorations.

To model the load imposed on the slope by the roadway, a 500 psf load was modeled at the approximate roadway location. Typically, the required minimum factors of safety are 1.5 for static conditions and 1.1 for seismic (pseudostatic) conditions. The results of our analyses indicate that the slope configuration described above meets both these requirements. The slope stability data are attached as Figure Nos. 5 and 6, *Stability Results*. Any modifications to the slope, including the construction of retaining walls, should be properly designed and engineered.

Conclusions and Recommendations

Based on the results of our analyses, the rock retaining walls at this site will be stable if constructed as follows (see Figure No. 7):

- The rock walls can be constructed using a single tier rock wall system with a maximum exposed height of 7 feet.

- The rock wall should be composed of boulders with a minimum nominal size (diameter) of 48 inches for the lowest row of rocks, grading in size to 24 inches for the top row of rocks.
- The bottom row of rock boulders can be embedded below the ground surface.
- The rock walls facing should slope at 1H:2V or flatter.
- We recommend that the backfill soil retained by the rock wall should consist of a cobble or gravel fill material meeting the following recommendations:

Sieve Size/Other	Percent Passing (by weight)
6 inches	100
No. 4	40 - 100
No. 40	20 - 50
No. 200	0 - 10
Liquid Limit	35 maximum
Plasticity Index	15 maximum

- Soils used as backfill should be placed in loose lifts not exceeding a thickness of 12 inches, not exceeding a thickness of 12 inches, and compacted to until minimal deflection.
- Boulders used in the rock wall should be durable (i.e. not sandstone, limestone and other rocks which have weakened planes that could cause rocks to split) and placed in a manner that will not significantly weaken their internal integrity. There should be maximum rock-to-rock contact when placing the rock boulders and no rocks should bear on a downward sloping face of any supporting rocks. Larger gaps may be filled with smaller rocks or sealed with a cement grout.
- Drainage behind the wall is recommended, as shown on Figure No. 7. The drain should consist of a perforated 4-inch minimum diameter pipe wrapped in fabric and placed at the bottom and behind the lowest row of boulders. The pipe should daylight at one or both ends of the wall and discharge to an appropriate drainage device or area. Clean gravel up to 2 inches in maximum size, with less than 10% passing the No. 4 sieve and less than 5% passing the No. 200 sieve, should be placed around the drain pipe. A Miradrain (or equivalent), should be placed between the gravel or cobble fill and the adjacent soils at 1H:2½V or flatter. This drainage system should be constructed to within one foot of the ground surface.
- The rock wall at this site has been designed to retain a slope with a roadway. Additional structures and loads should not be placed on the slope above the rock wall system without proper engineering of the rock walls. Future grading of the slope above the proposed rock wall system should not occur until the slope has been properly engineered.

Inspection Scheduling

Finally, we recommend that a representative of Earthtec Engineering visit the site during construction to observe implementation and compliance with our design and recommendation. We proposed the following inspections:

1. Site visit at the first row of rock for inspection of rock bedding recommendations, embedment, and drain construction.

2. Final to verify the compaction, type of fill, retaining wall batter, exposed heights, and back slope geometry.

Closure

Note that wall movements or even failure can occur if the retaining walls are undermined or the backfill soils become saturated. Therefore, we recommend that irrigation lines not be placed within the backfill or directly on top of the wall. Surface drainage at the bottom of the walls should also be directed away from the wall. A drainage system should be inspected periodically so that drains work as designed. The property owner should be made aware of the risks should these or other conditions occur that could saturate or erode/undermine the soil behind the wall.

The conclusions and recommendations presented in this letter are based on the information provided by the client, the soil conditions observed, and our experience with similar conditions. If conditions are different during construction than presented herein, please advise us so that any appropriate modifications can be made. Our observations, analyses, conclusions and recommendations were conducted within the limits prescribed by our client, with the usual thoroughness and competence of the engineering profession in the area at this time. No warranty or representation is intended in our proposals, contracts, or reports.

We appreciate the opportunity of providing our services on this project. If we can answer questions or be of further service, please call.

Respectfully;
EARTHTEC ENGINEERING



Caleb R. Allred, E.I.T.
Project Engineer

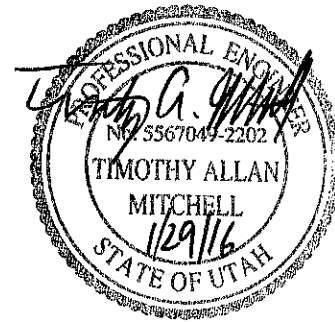

Timothy A. Mitchell, P.E.
Geotechnical Engineer

Attachments:

- | | |
|--------------------|--|
| Figure No. 1, | <i>Site Plan Showing Location of Rock Wall and Slope Cross-Section</i> |
| Figure Nos. 2 - 3, | <i>Direct Shear Results</i> |
| Figure No. 4, | <i>Rock Wall Stability Evaluation</i> |
| Figure Nos. 5 - 6, | <i>Stability Results</i> |
| Figure No. 7, | <i>Rock Wall Design</i> |
| <i>Appendix</i> | <i>Program Outputs</i> |

DIRECT SHEAR TEST

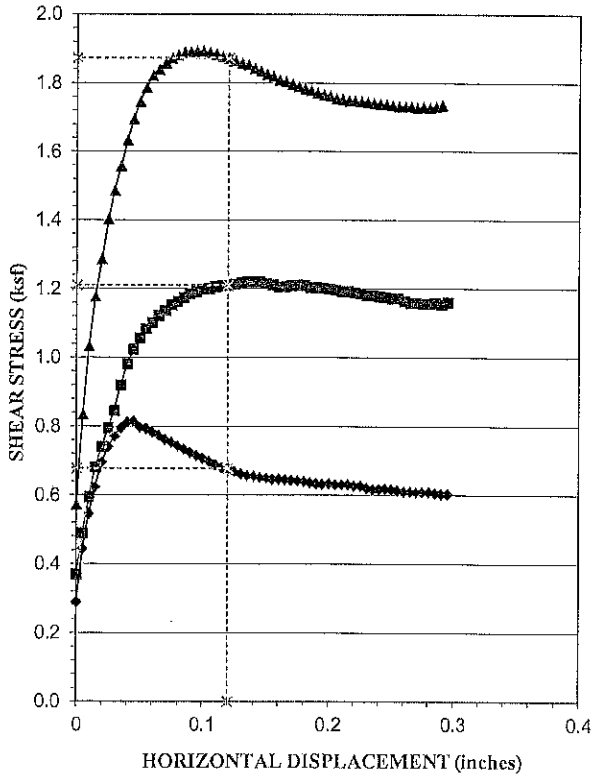
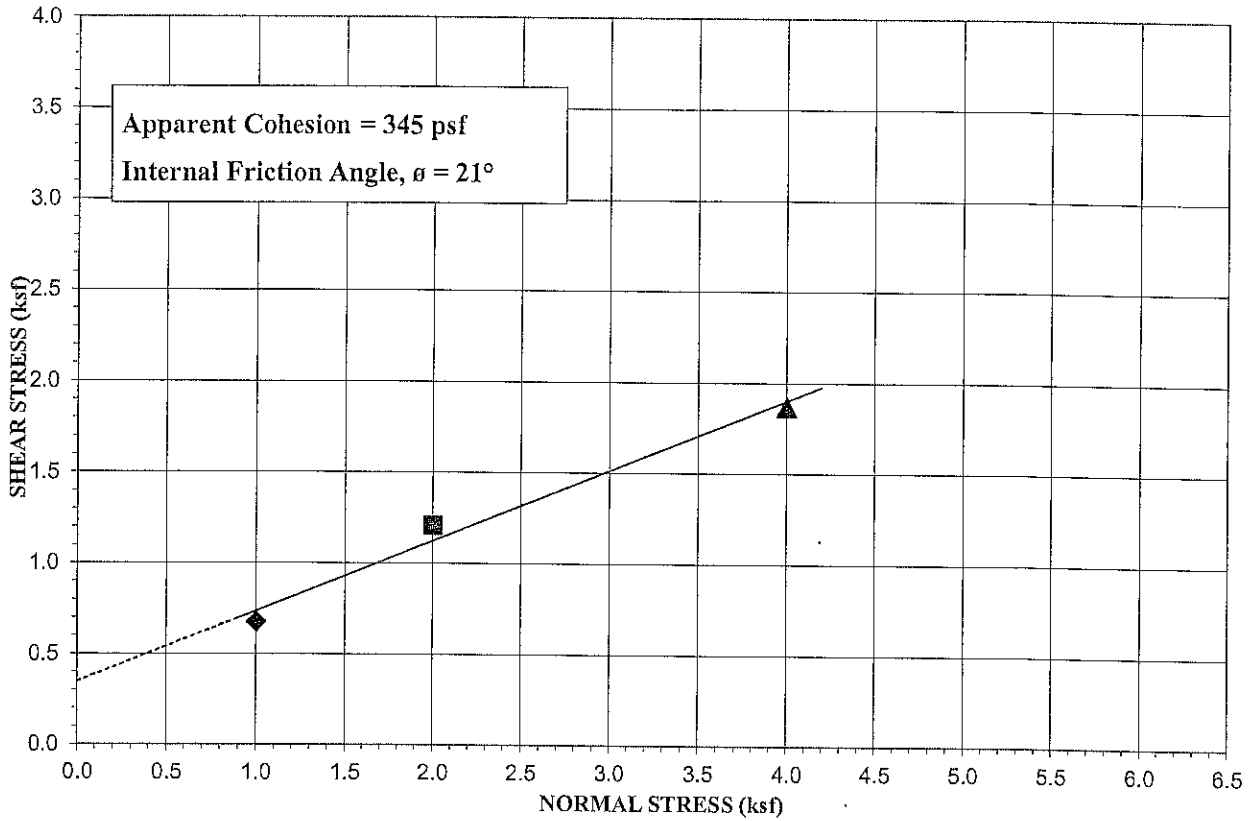

Source: TP-1	Depth: 3½ ft		
Type of Test:	Consolidated Drained/Saturated		
Test No. (Symbol)	1 (◆)	2 (■)	3 (▲)
Sample Type	Undisturbed		
Initial Height, in.	1	1	1
Diameter, in.	2.4	2.4	2.4
Dry Density Before, pcf	88.2	84.7	86.7
Dry Density After, pcf	89.4	78.3	88.6
Moisture % Before	25.9	25.9	25.9
Moisture % After	34.3	44.2	32.5
Normal Load, ksf	1.0	2.0	4.0
Shear Stress, ksf	0.68	1.21	1.87
Strain Rate	.0000566 IN/SEC		
Sample Properties			
Cohesion, psf	345		
Friction Angle, ϕ	21		
Liquid Limit, %	79		
Plasticity Index, %	49		
Percent Gravel	0		
Percent Sand	29		
Percent Passing No. 200 sieve	71		
Classification	Fat CLAY with sand (CH)		

PROJECT: Lot 15, Ski Lake Estates No. 3

PROJECT NO.: 145150G



FIGURE NO.: 2

DIRECT SHEAR TEST

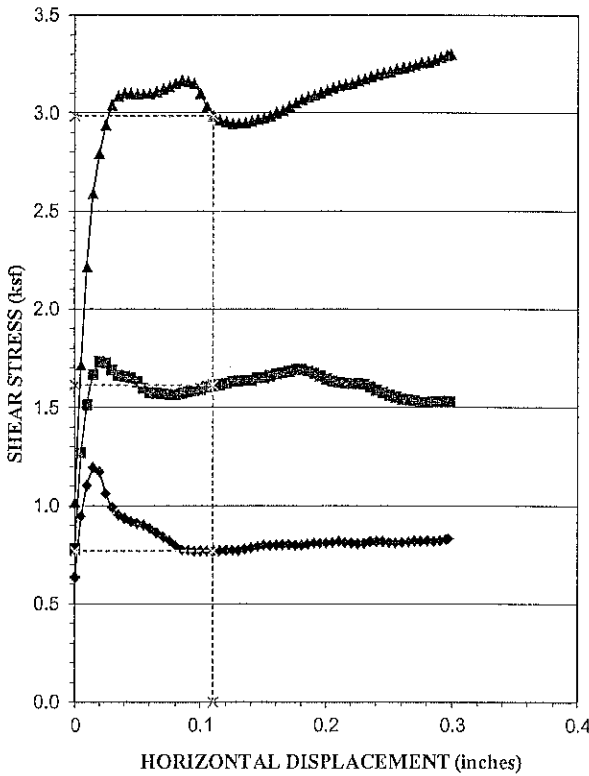
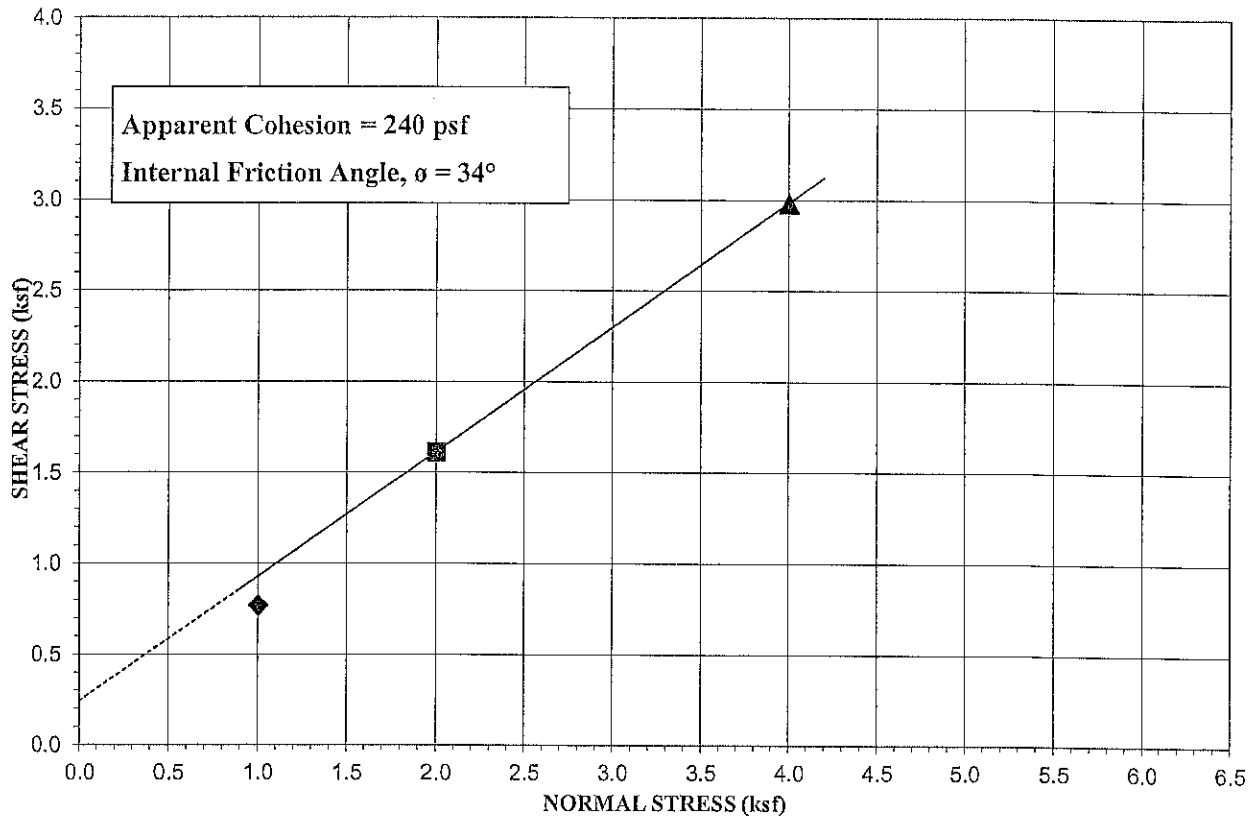

Source: TP-3	Depth: 11.0 ft	
Type of Test:	Consolidated Drained/Saturated	
Test No. (Symbol)	1 (◆)	2 (■) 3 (▲)
Sample Type	Remolded	
Initial Height, in.	1	1 1
Diameter, in.	2.4	2.4 2.4
Dry Density Before, pcf	95.5	95.5 95.3
Dry Density After, pcf	95.9	80.2 98.7
Moisture % Before	16.2	16.2 16.2
Moisture % After	42.7	70.7 36.2
Normal Load, ksf	1.0	2.0 4.0
Shear Stress, ksf	0.77	1.61 2.98
Strain Rate	.00005240 IN/SEC	
Sample Properties		
Cohesion, psf	240	
Friction Angle, ϕ	34	
Liquid Limit, %	33	
Plasticity Index, %	NP	
Percent Gravel	0	
Percent Sand	70	
Percent Passing No. 200 sieve	30	
Classification	Silty SAND (SM)	

PROJECT: Lot 15 Ski Lakes Estates No. 3

PROJECT NO.: 145150G



FIGURE NO.: 3

ROCK WALL STABILITY EVALUATION

Project:	Lot 15 , Ski Lake Estates No. 3	Date:	1/28/2016
Location:	Huntsville, Utah	By:	CRA
Backfill slope angle, β :	16 degrees	Foundation soil γ :	120 pcf
Backcut angle (from vertical):	21.8 degrees	Foundation soil Φ :	34 degrees
Batter angle (from vertical):	26.6 degrees	Found. soil cohesion:	0 psf
Soil/wall interface friction:	0 degrees	Retained soil γ :	120 pcf
Surcharge pressure:	150 psf (Usually 0 for $\beta > 0$)	Retained soil Φ :	32 degrees
FS against sliding (Stat/Seis):	1.5 1.1	Retain. soil cohesion:	0 psf
FS against overturning (St/Se):	2.0 1.5	Rock boulder γ :	145 psf
FS for bearing (Static/Seismic):	2.0 1.5	Rock boulder Φ :	45 degrees
Horizontal seismic coeff., k_h :	0.193 (typically 1/2 PGA)	Embedment depth:	0 feet
Vertical seismic coeff., k_v :	0 (typically 0)	Average rock wall γ :	145 pcf
Rock to Rock interface factor:	0.67 (typically 2/3)	Min. top rock size:	24 inches
Mononobe-Okabe theta, $\theta =$	0.190656	Min. bottom rock size:	48 inches
Mononobe-Okabe $K_{ae} =$	0.416252	Coulomb $K_a =$	0.208 (no surcharge)
		Passive Resist. $K_p =$	1.203 F.S. = 1.5 (typ.)

STATIC

Wall Ht, H (ft)	3.0	4.0	5.0	6.0	7.0	8.0	9.0	10.0
P_a (lbs/ft)	104	186	290	418	569	743	940	1161
Wall Wt, W (lbs/ft)	1305	1740	2175	2610	3045	3480	3915	4350
Wall $x_{centroid}$ (ft)	2.50	3.00	3.50	4.00	4.51	5.01	5.51	6.01
$P_{sliding}$ (lbs/ft)	124	212	323	457	614	795	999	1226
$P_{resisting}$ (lbs/ft)	756	925	1022	1030	931	707	340	-188
FS_{base sliding}	6.1	4.4	3.2	2.3	1.5	0.9	0.3	-0.2
FS_{interface shear}	7.1	5.5	4.5	3.8	3.3	2.9	2.6	2.4
$M_{overturn}$ (ft-lbs/ft)	134	300	565	953	1487	2189	3084	4195
$M_{resisting}$ (ft-lbs/ft)	3705	6047	8955	12438	16505	21165	26428	32304
FS_{overturn}	27.7	20.2	15.8	13.1	11.1	9.7	8.6	7.7
Eccentricity, e (ft)	0.00	0.00	0.00	0.00	0.00	0.00	0.00	0.00
Bearing Pressure	316	416	515	611	704	796	885	971
Bearing Capacity	1871	2377	2883	3388	3894	4400	4906	5411
FS_{bearing}	5.9	5.7	5.6	5.5	5.5	5.5	5.5	5.6

SEISMIC

P_{ae} (lbs/ft)	222	396	620	893	1217	1591	2014	2488
$P_{sliding}$ (lbs/ft)	448	677	944	1251	1597	1983	2408	2872
$P_{resisting}$ (lbs/ft)	2032	2613	3116	3524	3818	3980	3994	3840
FS_{base sliding}	4.5	3.9	3.3	2.8	2.4	2.0	1.7	1.3
FS_{interface shear}	4.0	3.0	2.4	2.0	1.7	1.5	1.3	1.2
$M_{overturn}$ (ft-lbs/ft)	642	1281	2219	3509	5203	7353	10012	13231
$M_{resisting}$ (ft-lbs/ft)	3568	5791	8536	11806	15607	19943	24819	30240
FS_{overturn}	5.6	4.5	3.8	3.4	3.0	2.7	2.5	2.3
Eccentricity (ft)	0.39	0.83	1.25	1.64	2.01	2.36	2.68	2.96
Bearing Pressure	486	895	1396	1972	2605	3277	3969	4665
FS_{bearing}	3.9	2.7	2.1	1.7	1.5	1.3	1.2	1.2

Max. Recommended Wall Height: 7 feet for 24-inch (top row) to 48-inch (bottom row) size boulders

Notes:

1. Equations from "Recommended Rockery Design & Construction Guidelines" Publication FHWA-CLF/TD-06-006, Nov. 2006.
2. Cohesion included in active pressure force by subtracting ($2 * c * \sqrt{K_a}$), but force is not allowed to be less than 0.
3. Other equations: $W = [\text{average rock diameter} * H] * \gamma_{rock}$; $FS_{interface\ shear} = (\text{Rock to Rock interface factor}) * [W * \tan(\Phi_{rock}) / P_{sliding}]$

PROJECT NO.: 145150



FIGURE NO.: 4

STABILITY RESULTS

Lot 15 Ski Lake States No. 3, Static
 Ten Most Critical Surfaces. 145150RT .OPT Run By: Earthtec 1-28-16

Soil No.	TotWt (pcf)	SatWt (pcf)	C (psf)	Phi (deg)	Ru Param	Pore Press	Piez Surf #
1	100	134	240	34	0	0	1
2	145	145	1000	0	0	0	1
3	113	130	200	20	0	0	1
4	135	135	0	34	0	0	1

#	FS
1	2.11
2	2.11
3	2.12
4	2.13
5	2.21
6	2.26
7	2.27
8	2.28
9	2.29
10	2.29

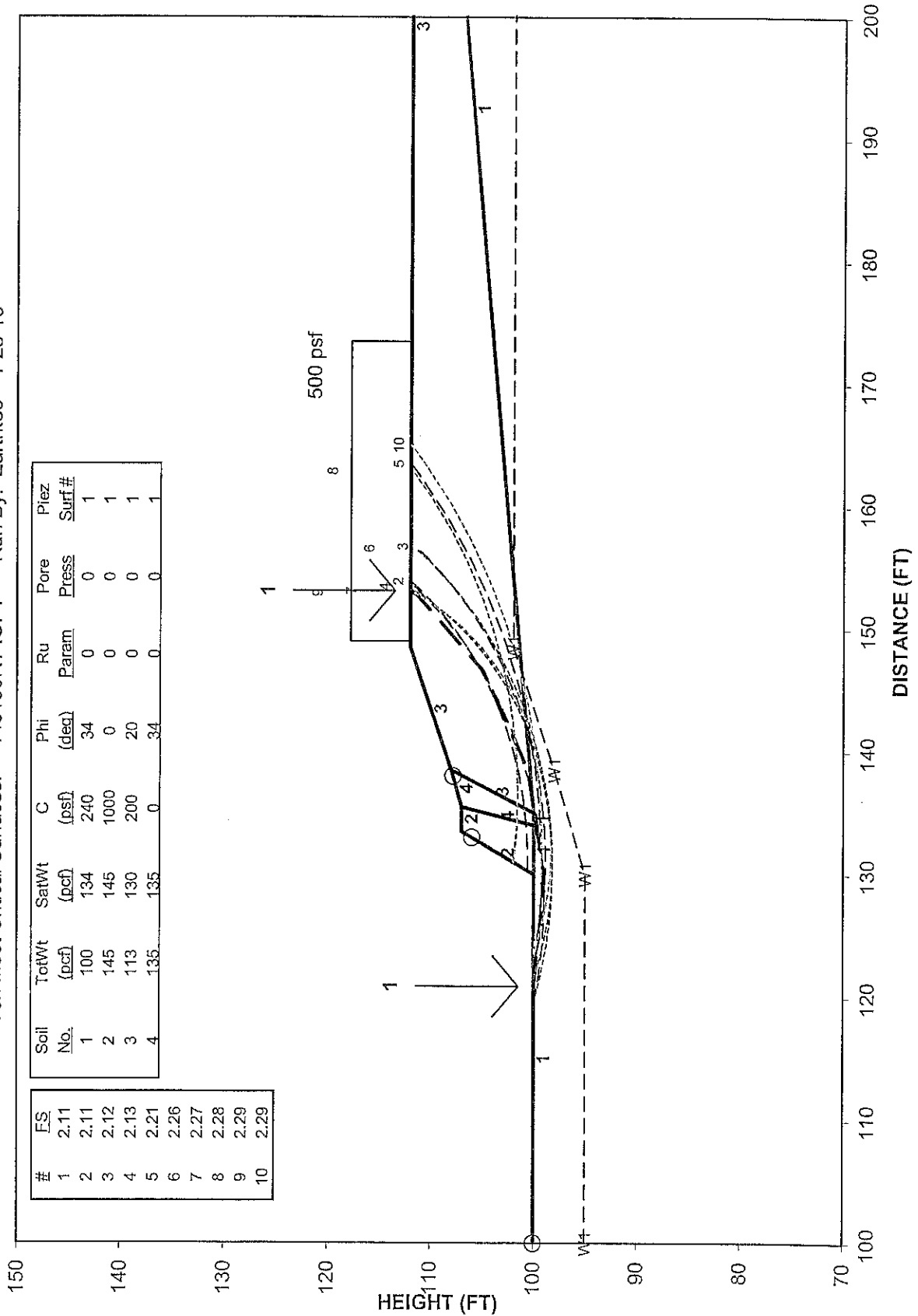

STABILITY RESULTS

Lot 15 Ski Lake States No. 3, Seismic
 Ten Most Critical Surfaces. 145150RS.OPT Run By: Earthtec 1-28-16

Pseudostatic Coefficient = 0.193

Soil No.	TotWt (pcf)	SatWt (pcf)	C (psf)	Phi (deg)	Ru Param	Pore Press	Piez Surf #
1	100	134	240	34	0	0	1
2	145	145	1000	0	0	0	1
3	113	130	200	20	0	0	1
4	135	135	0	34	0	0	1

#	ES
1	1.55
2	1.55
3	1.55
4	1.56
5	1.56
6	1.58
7	1.60
8	1.65
9	1.65
10	1.66

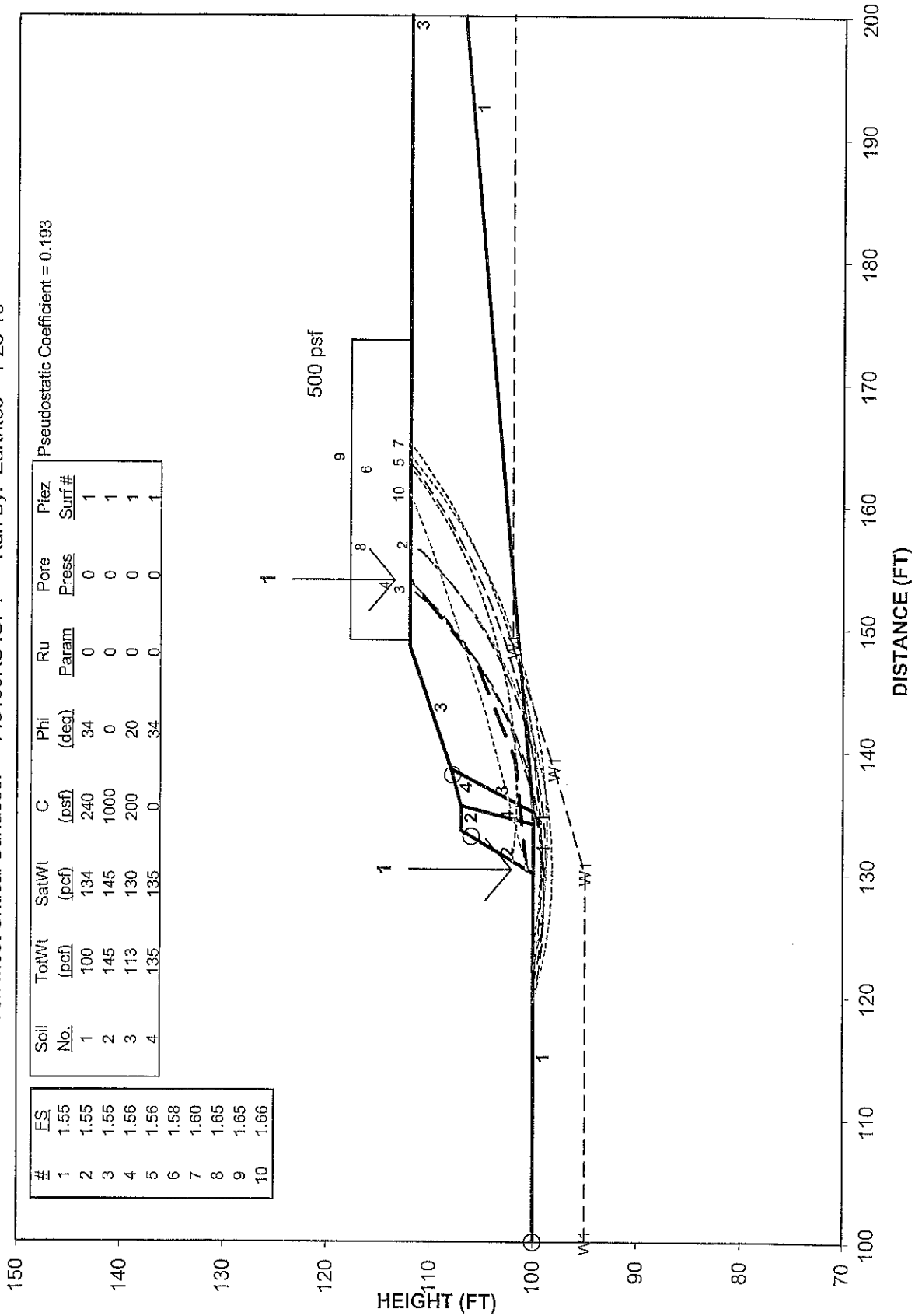

ROCK WALL DETAIL

LOT 15 , SKI LAKE ESTATES NO. 3, HUNTSVILLE

NOTES:

1. BACKFILL SOILS SHOULD CONSIST OF A COBBLE FILL AND BE PLACED IN LOOSE LIFTS NOT EXCEEDING A THICKNESS OF 12 INCHES, AND COMPACTED TO UNTIL MINIMAL DEFLECTION.
2. FREE-DRAINING BACKFILL SHALL CONSIST OF GRAVEL AND COBBLE HAVING LESS THAN 10% PASSING No. 200 SIEVE, AND OUTER INTERFACE LINED WITH MIRADRAIN (OR EQUIV.)
3. PERFORATED DRAIN SHALL BE WRAPPED WITH FABRIC, SLOPED A MINIMUM 2% TO SIDE OF WALL, AND DISCHARGED TO APPROPRIATE DRAINAGE DEVICE.
4. BOULDER SIZES SHALL BE A MINIMUM 48 INCHES FOR THE BOTTOM ROW AND A MINIMUM 24 INCHES FOR THE UPPER ROW FOR EACH TIER.

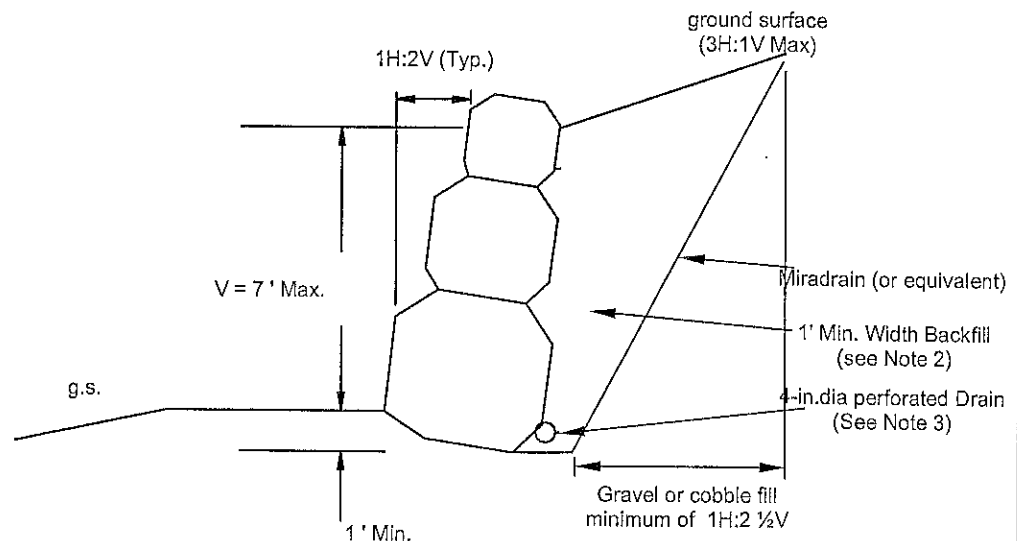

NOT TO SCALE

PROJECT NO.: 145150



FIGURE NO.: 7

```

*****
*                               *
*           X S T A B L         *
*                               *
*           Slope Stability Analysis *
*           using the             *
*           Method of Slices      *
*                               *
*           Copyright (C) 1992 Å 94 *
*           Interactive Software Designs, Inc. *
*           Moscow, ID 83843, U.S.A. *
*                               *
*           All Rights Reserved    *
*                               *
*           Ver. 5.004             *
*                               *
*****

```

Problem Description : Lot 15 Ski Lake States No. 3, Static

SEGMENT BOUNDARY COORDINATES

6 SURFACE boundary segments

Segment No.	x-left (ft)	y-left (ft)	x-right (ft)	y-right (ft)	Soil Unit Below Segment
1	100.0	100.0	130.0	100.0	1
2	130.0	100.0	133.5	107.0	2
3	133.5	107.0	135.5	107.0	2
4	135.5	107.0	138.5	108.0	4
5	138.5	108.0	148.5	112.0	3
6	148.5	112.0	250.0	112.0	3

5 SUBSURFACE boundary segments

Segment No.	x-left (ft)	y-left (ft)	x-right (ft)	y-right (ft)	Soil Unit Below Segment
1	130.0	100.0	134.0	100.0	1
2	134.0	100.0	135.5	107.0	4
3	134.0	100.0	135.0	100.0	1
4	135.0	100.0	138.5	108.0	3
5	135.0	100.0	250.0	112.0	1

ISOTROPIC Soil Parameters

4 soil unit(s) specified

Soil Unit No.	Unit weight Moist (pcf)	Sat. (pcf)	Cohesion Intercept (psf)	Friction Angle (deg)	Pore Pressure Parameter Ru	Water Surface Constant (psf)	Water Surface No.

			145150RT					
1	100.0	134.0	240.0	34.00	.000	.0	1	
2	145.0	145.0	1000.0	.00	.000	.0	1	
3	113.0	130.0	200.0	20.00	.000	.0	1	
4	135.0	135.0	.0	34.00	.000	.0	1	

1 water surface(s) have been specified

Unit weight of water = 62.40 (pcf)

Water surface No. 1 specified by 5 coordinate points

 PHREATIC SURFACE,

Point No.	x-water (ft)	y-water (ft)
1	100.00	95.00
2	130.00	95.00
3	138.50	98.00
4	148.50	102.00
5	250.00	102.00

BOUNDARY LOADS

1 load(s) specified

Load No.	x-left (ft)	x-right (ft)	Intensity (psf)	Direction (deg)
1	149.0	173.5	500.0	.0

NOTE - Intensity is specified as a uniformly distributed force acting on a HORIZONTALLY projected surface.

A critical failure surface searching method, using a random technique for generating CIRCULAR surfaces has been specified.

1000 trial surfaces will be generated and analyzed.

20 surfaces initiate from each of 50 points equally spaced along the ground surface between x = 100.0 ft and x = 133.0 ft

Each surface terminates between x = 138.0 ft and x = 250.0 ft

Unless further limitations were imposed, the minimum elevation at which a surface extends is y = .0 ft

9.0 ft line segments define each trial failure surface.

ANGULAR RESTRICTIONS :

The first segment of each failure surface will be inclined within the angular range defined by :

Lower angular limit := -45.0 degrees
Upper angular limit := (slope angle - 5.0) degrees

-- WARNING -- WARNING -- WARNING -- WARNING -- (# 48)

Negative effective stresses were calculated at the base of a slice.
This warning is usually reported for slices that have low self weight
and a relatively high "c" shear strength parameter. This effect can
be eliminated by inserting a crack or by reducing the "c" value.

USER SELECTED option to maintain strength greater than zero

** Factor of safety calculation for surface # 985 **
** failed to converge within FIFTY iterations **
**
** The last calculated value of the FOS was -191.971 **
** This will be ignored for final summary of results **

ERROR #48: NEGATIVE effective stress calculated for at least
14 slice(s) out of 27 slices for surface # 985

Circular surface (FOS =500.000) is defined by: xcenter = 180.63
ycenter = 148.61 Init. Pt. = 133.00 Seg. Length = 9.00

** Factor of safety calculation for surface # 989 **
** failed to converge within FIFTY iterations **
**
** The last calculated value of the FOS was -557.596 **
** This will be ignored for final summary of results **

ERROR #48: NEGATIVE effective stress calculated for at least

145150RT
 6 slice(s) out of 27 slices for surface # 989

Circular surface (FOS =500.000) is defined by: xcenter = 181.42
 ycenter = 151.51 Init. Pt. = 133.00 Seg. Length = 9.00

Factors of safety have been calculated by the :

* * * * * SIMPLIFIED BISHOP METHOD * * * * *

The most critical circular failure surface
 is specified by 6 coordinate points

Point No.	x-surf (ft)	y-surf (ft)
1	120.88	100.00
2	129.81	98.94
3	138.65	100.63
4	146.57	104.91
5	152.82	111.39
6	153.12	112.00

**** Simplified BISHOP FOS = 2.106 ****

 **
 ** Out of the 1000 surfaces generated and analyzed by XSTABL, **
 ** 6 surfaces were found to have MISLEADING FOS values. **
 **

The following is a summary of the TEN most critical surfaces

Problem Description : Lot 15 Ski Lake States No. 3, Static

	FOS (BISHOP)	Circle Center x-coord (ft)	Circle Center y-coord (ft)	Radius (ft)	Initial x-coord (ft)	Terminal x-coord (ft)	Resisting Moment (ft-lb)
1.	2.106	128.78	128.34	29.42	120.88	153.12	4.687E+05
2.	2.113	131.30	128.75	28.15	130.31	153.90	3.892E+05
3.	2.119	130.98	131.22	32.42	122.22	156.75	6.696E+05
4.	2.134	127.70	131.51	32.55	119.53	153.47	5.221E+05
5.	2.211	130.47	148.25	49.07	121.55	163.51	1.223E+06
6.	2.261	130.28	130.81	32.63	119.53	156.59	7.386E+05
7.	2.274	130.95	123.18	25.02	121.55	153.14	4.822E+05
8.	2.275	136.50	140.75	39.18	130.98	162.92	7.520E+05
9.	2.287	132.23	121.10	22.81	123.57	152.96	4.344E+05
10.	2.289	132.30	147.57	48.37	123.57	165.04	1.296E+06

145150RT

* * * END OF FILE * * *

```

*****
*                               *
*           X S T A B L         *
*                               *
*           Slope Stability Analysis *
*           using the           *
*           Method of Slices     *
*                               *
*           Copyright (C) 1992 Å 94 *
*           Interactive Software Designs, Inc. *
*           Moscow, ID 83843, U.S.A. *
*                               *
*           All Rights Reserved   *
*                               *
*           Ver. 5.004           94 Å 1295 *
*****

```

Problem Description : Lot 15 Ski Lake States No. 3, Seismi

SEGMENT BOUNDARY COORDINATES

6 SURFACE boundary segments

Segment No.	x-left (ft)	y-left (ft)	x-right (ft)	y-right (ft)	Soil Unit Below Segment
1	100.0	100.0	130.0	100.0	1
2	130.0	100.0	133.5	107.0	2
3	133.5	107.0	135.5	107.0	2
4	135.5	107.0	138.5	108.0	4
5	138.5	108.0	148.5	112.0	3
6	148.5	112.0	250.0	112.0	3

5 SUBSURFACE boundary segments

Segment No.	x-left (ft)	y-left (ft)	x-right (ft)	y-right (ft)	Soil Unit Below Segment
1	130.0	100.0	134.0	100.0	1
2	134.0	100.0	135.5	107.0	4
3	134.0	100.0	135.0	100.0	1
4	135.0	100.0	138.5	108.0	3
5	135.0	100.0	250.0	112.0	1

ISOTROPIC Soil Parameters

4 Soil unit(s) specified

Soil Unit No.	Unit Weight Moist (pcf)	Weight Sat. (pcf)	Cohesion Intercept (psf)	Friction Angle (deg)	Pore Pressure Parameter Ru	Water Surface Constant (psf)	Water Surface No.
1							
2							
3							
4							

	145150RS						
1	100.0	134.0	240.0	34.00	.000	.0	1
2	145.0	145.0	1000.0	.00	.000	.0	1
3	113.0	130.0	200.0	20.00	.000	.0	1
4	135.0	135.0	.0	34.00	.000	.0	1

1 water surface(s) have been specified

Unit weight of water = 62.40 (pcf)

Water Surface No. 1 specified by 5 coordinate points

 PHREATIC SURFACE,

Point No.	x-water (ft)	y-water (ft)
1	100.00	95.00
2	130.00	95.00
3	138.50	98.00
4	148.50	102.00
5	250.00	102.00

A horizontal earthquake loading coefficient of .193 has been assigned

A vertical earthquake loading coefficient of .000 has been assigned

BOUNDARY LOADS

1 load(s) specified

Load No.	x-left (ft)	x-right (ft)	Intensity (psf)	Direction (deg)
1	149.0	173.5	500.0	.0

NOTE - Intensity is specified as a uniformly distributed force acting on a HORIZONTALLY projected surface.

A critical failure surface searching method, using a random technique for generating CIRCULAR surfaces has been specified.

1000 trial surfaces will be generated and analyzed.

20 Surfaces initiate from each of 50 points equally spaced along the ground surface between x = 100.0 ft and x = 133.0 ft

145150RS

Each surface terminates between x = 138.0 ft
and x = 250.0 ft

Unless further limitations were imposed, the minimum elevation
at which a surface extends is y = .0 ft

9.0 ft line segments define each trial failure surface.

ANGULAR RESTRICTIONS :

The first segment of each failure surface will be inclined
within the angular range defined by :

Lower angular limit := -45.0 degrees
Upper angular limit := (slope angle - 5.0) degrees

-- WARNING -- WARNING -- WARNING -- WARNING -- (# 48)

Negative effective stresses were calculated at the base of a slice.
This warning is usually reported for slices that have low self weight
and a relatively high "c" shear strength parameter. This effect can
be eliminated by inserting a crack or by reducing the "c" value.

USER SELECTED option to maintain strength greater than zero

Factors of safety have been calculated by the :

* * * * * SIMPLIFIED BISHOP METHOD * * * * *

The most critical circular failure surface
is specified by 5 coordinate points

Point No.	x-surf (ft)	y-surf (ft)
1	130.31	100.61
2	139.24	101.74
3	147.35	105.62
4	153.83	111.87
5	153.90	112.00

**** Simplified BISHOP FOS = 1.550 ****

145150RS

The following is a summary of the TEN most critical surfaces

Problem Description : Lot 15 Ski Lake States No. 3, Seismi

	FOS (BISHOP)	Circle x-coord (ft)	Center y-coord (ft)	Radius (ft)	Initial x-coord (ft)	Terminal x-coord (ft)	Resisting Moment (ft-lb)
1.	1.550	131.30	128.75	28.15	130.31	153.90	3.805E+05
2.	1.552	130.98	131.22	32.42	122.22	156.75	6.538E+05
3.	1.552	128.78	128.34	29.42	120.88	153.12	4.575E+05
4.	1.562	127.70	131.51	32.55	119.53	153.47	5.101E+05
5.	1.564	130.47	148.25	49.07	121.55	163.51	1.197E+06
6.	1.576	136.50	140.75	39.18	130.98	162.92	7.375E+05
7.	1.602	132.30	147.57	48.37	123.57	165.04	1.269E+06
8.	1.645	130.28	130.81	32.63	119.53	156.59	7.223E+05
9.	1.650	132.89	141.66	43.00	122.22	163.96	1.204E+06
10.	1.660	79.27	285.42	191.72	130.31	160.91	3.082E+06

* * * END OF FILE * * *