

Project Narrative/Notes/Revisions

- 1) 11/19/15 CK - COMPLETED DESIGN FOR CLIENT & CITY REVIEW.
- 2) 11/23/15 TH - QUALITY CONTROL CHECK & INTERNAL REVIEW.
- 3) 12/22/15 WS - PUMP DESIGN & IRRIGATION SYSTEM UPDATES.
- 4) 03/24/16 CK - UPDATED PLANS PER CITY COMMENTS.
- 5) 07/12/16 CK - REMOVED STUB ROAD PER CLIENT REQUEST.

Henry Flats Cluster Subdivision Improvement Plans

WEST WEBER CITY, WEBER COUNTY, UTAH
NOVEMBER, 2015



Vicinity Map
NOT TO SCALE

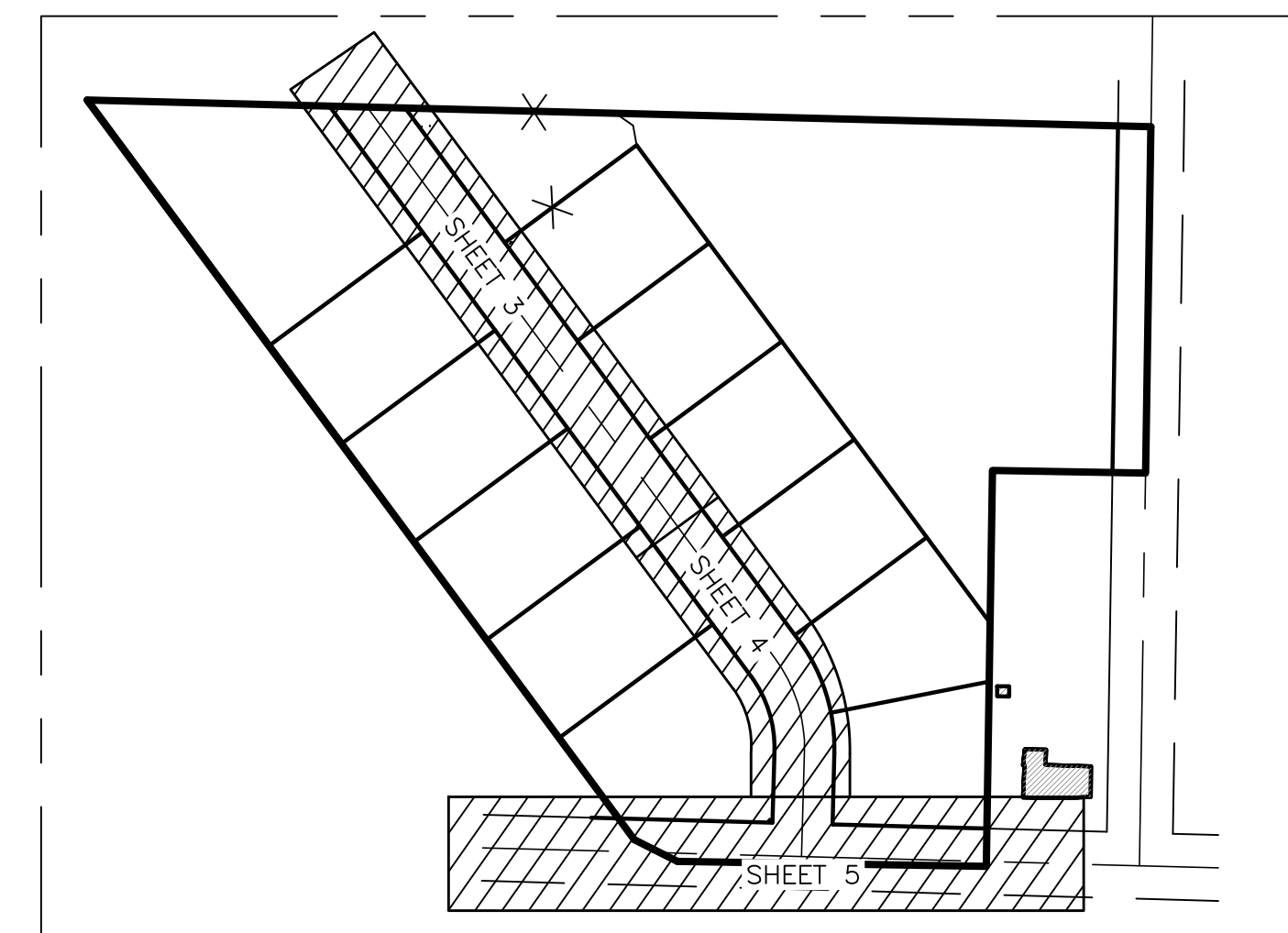

Sheet Index Key Map
NOT TO SCALE

Sheet Index

- Sheet 1 - Cover/Index Sheet
- Sheet 2 - Notes/Legend/Street Cross-Section
- Sheet 3 - Street Name - 4+50.00-10+50.00
- Sheet 4 - Street Name - 10+50.00-14+00.00
- Sheet 5 - 400 South Street - 6+00.00-11+00.00
- Sheet 6 - Master Utility Plan
- Sheet 7 - Master Grading and Drainage Plan
- Sheet 8 - Storm Water Pollution Prevention Plan Exhibit
- Sheet 9 - Storm Water Pollution Prevention Plan Details
- Sheet 10 - Irrigation Pump House Details
- Sheet 11 - Detention Basin Grading Plan
- Sheet 12 - APWA Details

Engineer's Notice To Contractors

THE EXISTENCE AND LOCATION OF ANY UNDERGROUND UTILITY PIPES OR STRUCTURES SHOWN ON THESE PLANS WERE OBTAINED FROM AVAILABLE INFORMATION PROVIDED BY OTHERS. THE LOCATIONS SHOWN ARE APPROXIMATE AND SHALL BE CONFIRMED IN THE FIELD BY THE CONTRACTOR, SO THAT ANY NECESSARY ADJUSTMENT CAN BE MADE IN ALIGNMENT AND/OR GRADE OF THE PROPOSED IMPROVEMENT. THE CONTRACTOR IS REQUIRED TO CONTACT THE UTILITY COMPANIES AND TAKE DUE PRECAUTIONARY MEASURE TO PROTECT ANY UTILITY LINES SHOWN, AND ANY OTHER LINES OBTAINED BY THE CONTRACTOR'S RESEARCH, AND OTHERS NOT OF RECORD OR NOT SHOWN ON THESE PLANS.

Developer Contact:

Travis Wallace
PAANC LLC
3872 W. 2550 S.
Taylor City, Weber Co., Utah
PH: (801) 540-9011

Blue Stakes Location Center

Call: Toll Free
1-800-662-4111
Two Working Days Before You Dig

VAN HANCOCK
VAL J. HANCOCK
15-049-0002

REX B. HANCOCK
& WF. SHARON
15-049-0011

BRETT A. TONKS
15-049-0004

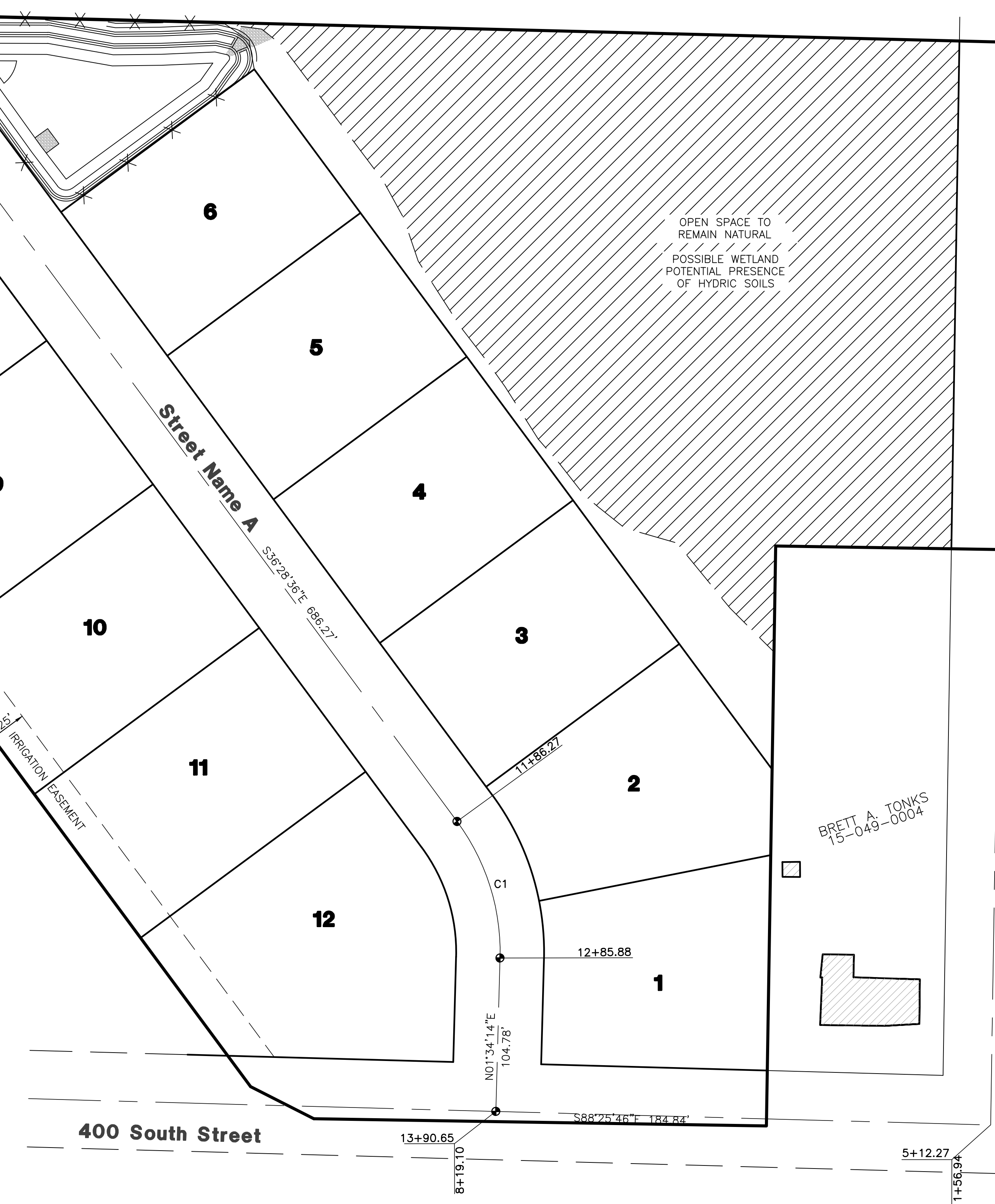

Centerline Curve Data

#	Delta	Radius	Length	Tangent	Chord	CH Length
C1	38°02'50"	150.00'	99.61'	51.72'	S17°27'11"E	97.79'

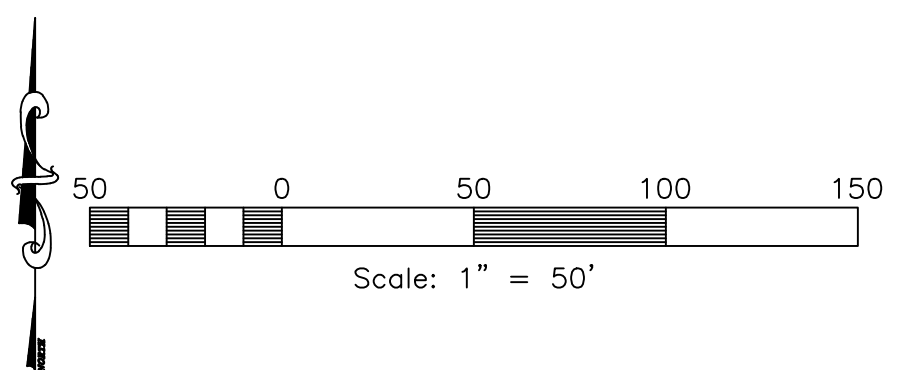

Reeve & Associates, Inc.
920 CHAMBERS STREET, SUITE 14, OGDEN, UTAH 84403
TEL: (801) 621-2100 FAX: (801) 621-2668 www.reeve-assoc.com
LAND PLANNERS • CIVIL ENGINEERS • LAND SURVEYORS
TRAFFIC ENGINEERS • STRUCTURAL ENGINEERS • LANDSCAPE ARCHITECTS

REVISIONS	DESCRIPTION	DATE

Henry Flats Cluster Subdivision
WEST WEBER CITY, WEBER COUNTY, UTAH
Cover/Index Sheet

Revised: 07-12-16

Project Info.

Engineer:	J. NATE REEVE
Drafter:	C. KINGSLEY
Begin Date:	NOVEMBER, 2015
Name:	HENRY FLATS CLUSTER SUBDIVISION
Number:	6272-01

Sheet	12
1	Sheets

Table with 2 columns: REVISIONS, DESCRIPTION. Includes a date field.

Henry Flats Cluster Subdivision
WEST WEBER CITY, WEBER COUNTY, UTAH
Street Name A
4+50.00 - 10+50.00

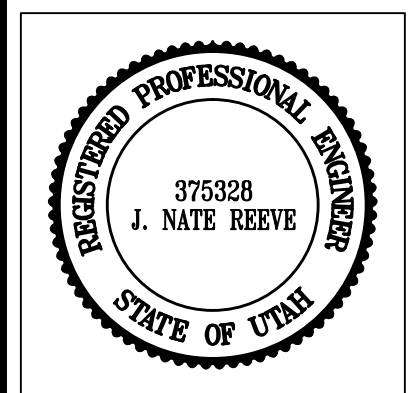

Project Info.
Engineer: J. NATE REEVE
Drafter: C. KINGSLEY
Begin Date: NOVEMBER, 2015
Name: HENRY FLATS CLUSTER SUBDIVISION
Number: 6272-01

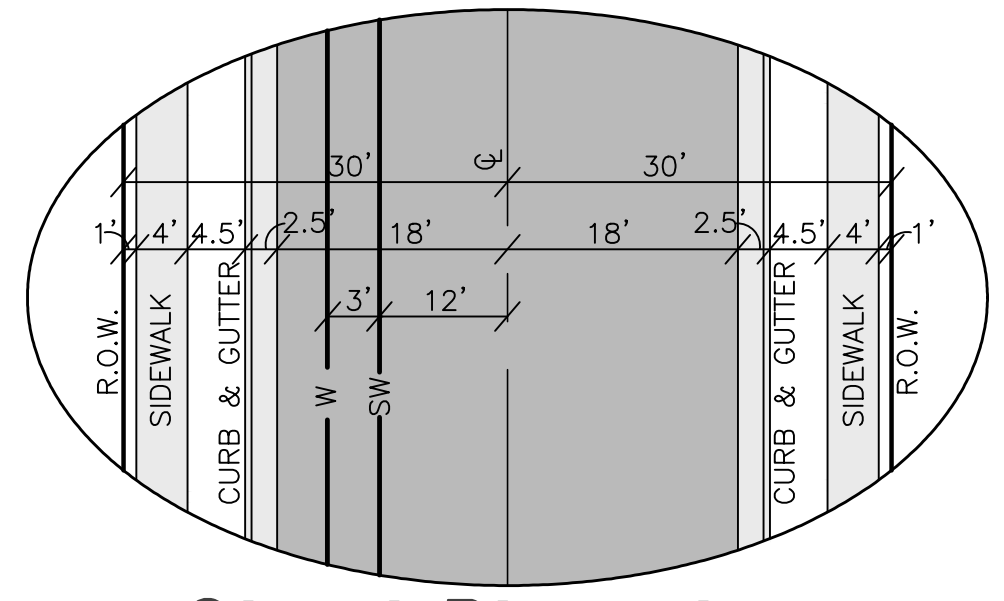
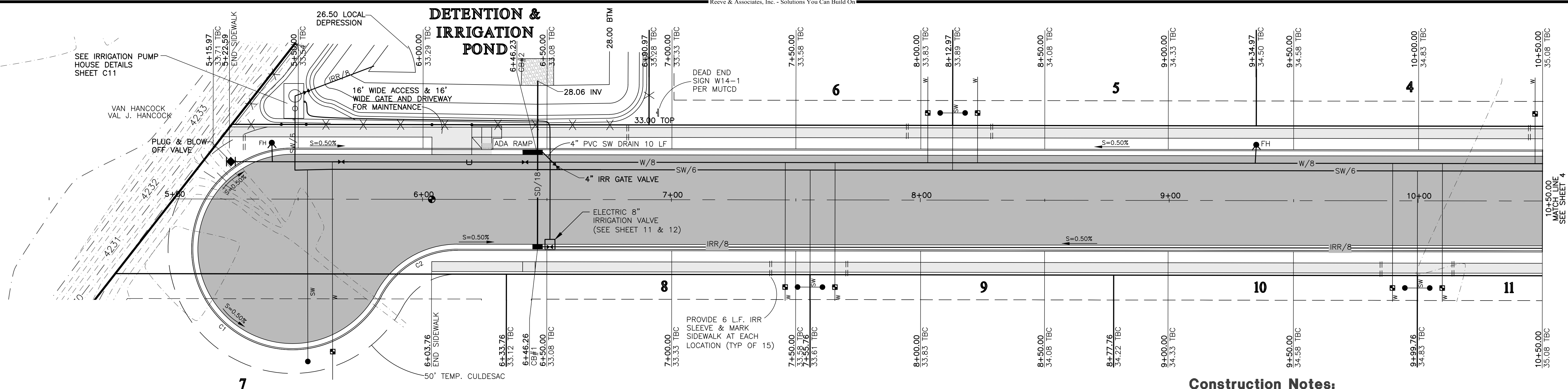

Street Dimensions
LOOKING UP-STATION

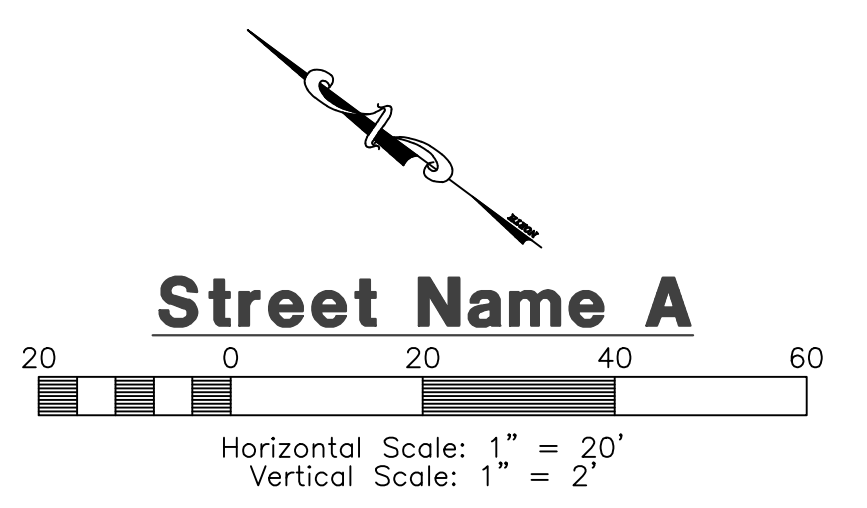

TBC Curve Data table with columns: #, Delta, Radius, Length, Tangent, Chord, CH Length. Includes curves C1 and C2.

Construction Notes:

- 1) ALL CONSTRUCTION IS TO CONFORM TO THE STANDARD DRAWINGS AND SPECIFICATIONS OF WEBER COUNTY & MANUAL OF STANDARD PLANS 2012 PUBLISHED BY APWA. WHEN IN CONFLICT, SEEK CLARIFICATION FROM WEBER COUNTY ENGINEERING DEPT.
2) ALL STORM DRAIN PIPE IS TO HAVE TYPE 2 BEDDING, LESS THAN 500 LBS PER ACPA FILL HEIGHT CHARTS.

- CULINARY WATER
W/8 - 8" PVC C-900 CLASS 200 WATER
W - 1" TYPE K COPPER SERVICE LATERAL
SANITARY SEWER
EACH LOT TO HAVE INDIVIDUAL SCEPTIC LINE
STORM DRAIN
SD/18 - 18" RCP STORM DRAIN (CLASS III)
SECONDARY WATER
SW/6 - 6" PVC C-900 SECONDARY WATER LINE
IRR/8 - 8" ASTM D3034 SDR 35 IRRIGATION LINE
SW - (DOUBLE SERVICE) 1.5" CTS HDPE PIPE SERVICE LATERAL
SW - (SINGLE SERVICE) 1" CTS HDPE PIPE SERVICE LATERAL

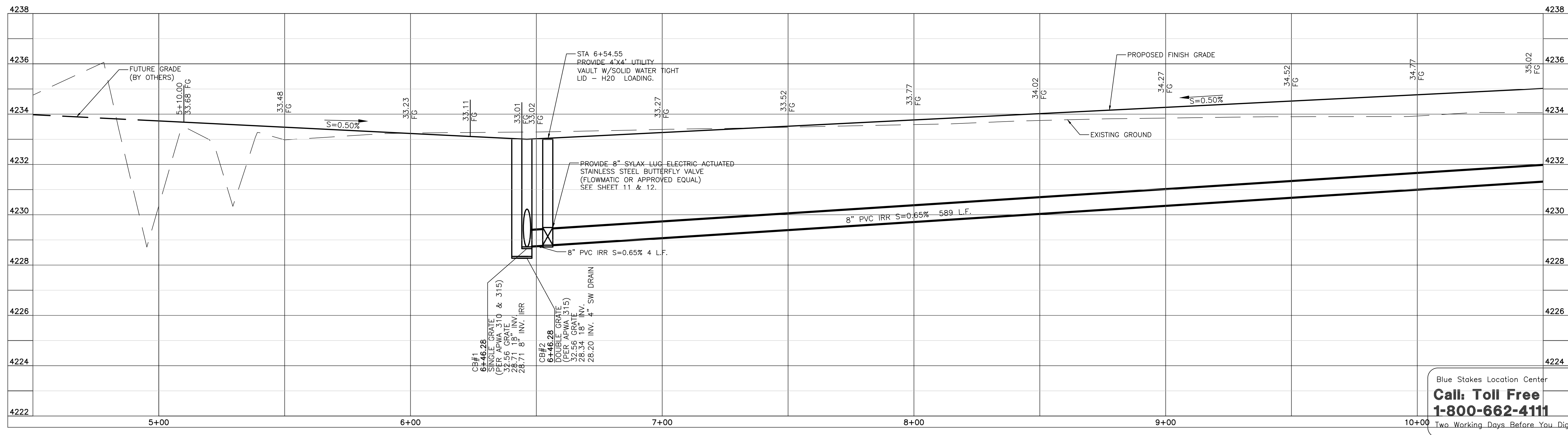
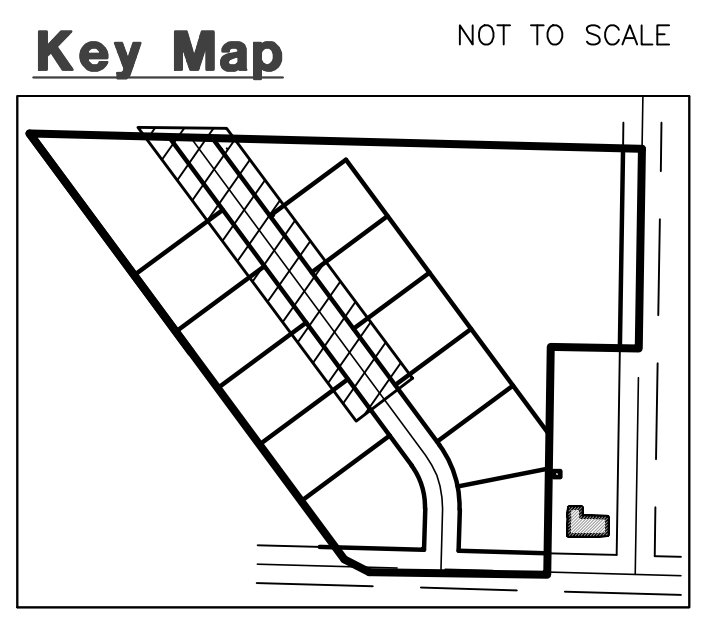

Blue Stakes Location Center
Call: Toll Free 1-800-662-4111
Two Working Days Before You Dig

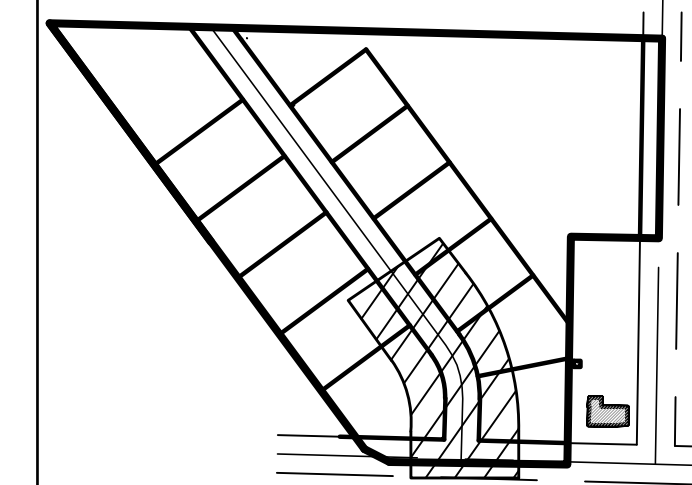

Construction Notes:

- ALL CONSTRUCTION IS TO CONFORM TO THE STANDARD DRAWINGS AND SPECIFICATIONS OF WEBER COUNTY & MANUAL OF STANDARD PLANS 2012 PUBLISHED BY APWA. WHEN IN CONFLICT, SEEK CLARIFICATION FROM WEBER COUNTY ENGINEERING DEPT.
- ALL STORM DRAIN PIPE IS TO HAVE TYPE 2 BEDDING, LESS THAN 500 LBS PER ACPA FILL HEIGHT CHARTS.

- CULINARY WATER**
 W/8 - 8" PVC C-900 CLASS 200 WATER
 W - 1" TYPE K COPPER SERVICE LATERAL
- SANITARY SEWER**
 EACH LOT TO HAVE INDIVIDUAL SCEPTIC LINE
- STORM DRAIN**
 SD/18 - 18" RCP STORM DRAIN (CLASS III)
- SECONDARY WATER**
 SW/6 - 6" PVC C-900 SECONDARY WATER LINE
 IRR/8 - 8" ASTM D3034 SDR 35 IRRIGATION LINE
 SW - (DOUBLE SERVICE) 1.5" CTS HDPE PIPE SERVICE LATERAL
 SW - (SINGLE SERVICE) 1" CTS HDPE PIPE SERVICE LATERAL

Reeve & Associates, Inc.
 920 CHAMBERS STREET, SUITE 14, OGDEN, UTAH 84403
 TEL: (801) 621-2100 FAX: (801) 621-2666 WWW.REVEE-ASSOC.COM
 LAND PLANNERS • CIVIL ENGINEERS • LAND SURVEYORS
 TRAFFIC ENGINEERS • STRUCTURAL ENGINEERS • LANDSCAPE ARCHITECTS

REVISIONS	DESCRIPTION

Reeve & Associates, Inc. - Solutions You Can Build On

Henry Flats Cluster Subdivision
 WEST WEBER CITY, WEBER COUNTY, UTAH

Street Name A
 10+50.00 - 14+00.00

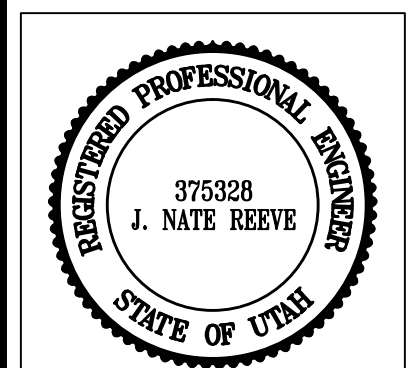

Project Info.

Engineer: J. NATE REEVE
 Drafter: C. KINGSLEY
 Begin Date: NOVEMBER, 2015
 Name: HENRY FLATS CLUSTER SUBDIVISION
 Number: 6272-01

Sheet	12
4	Sheets

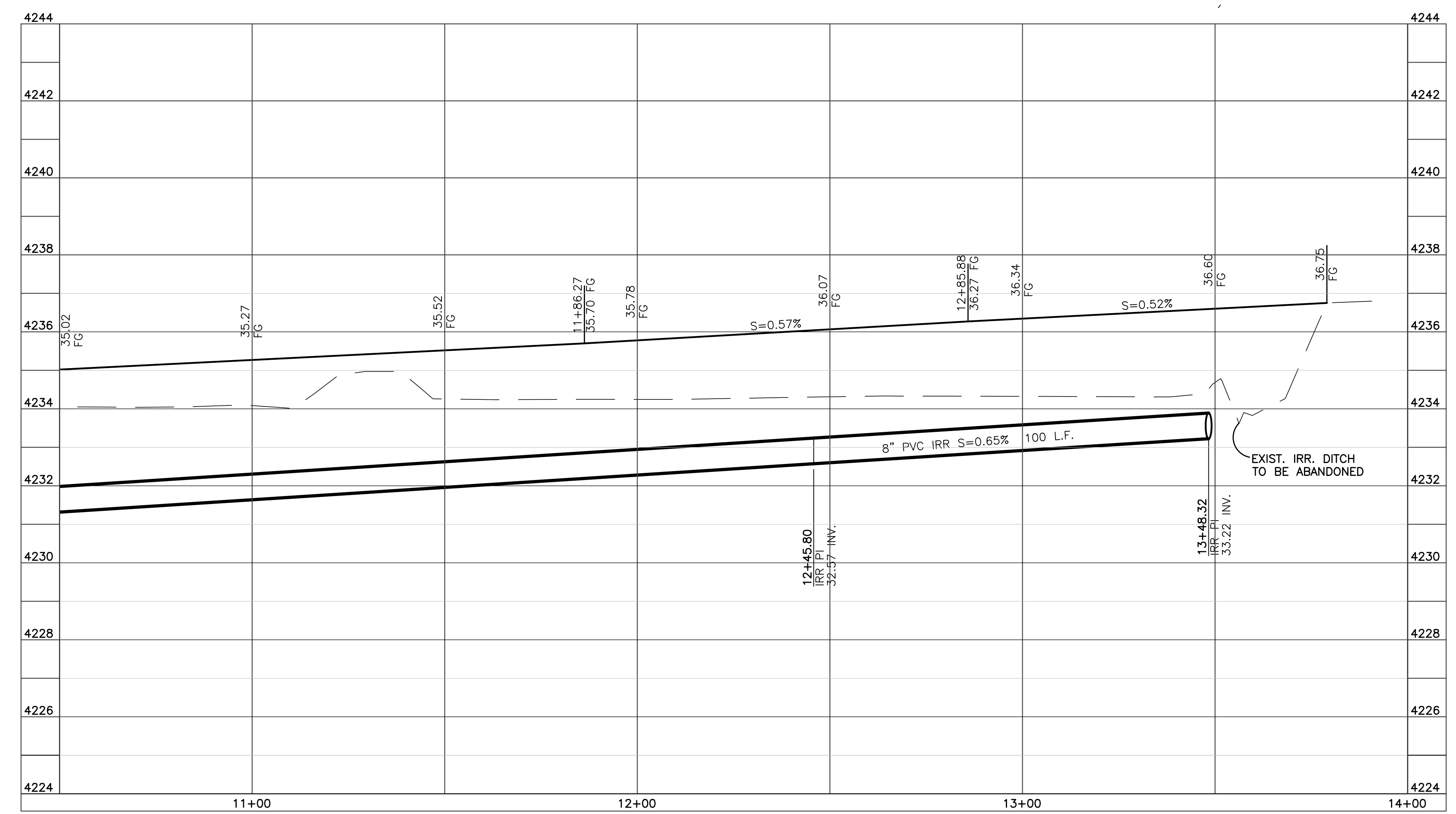
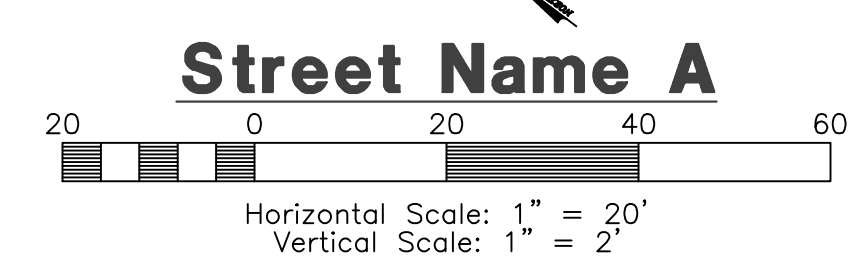
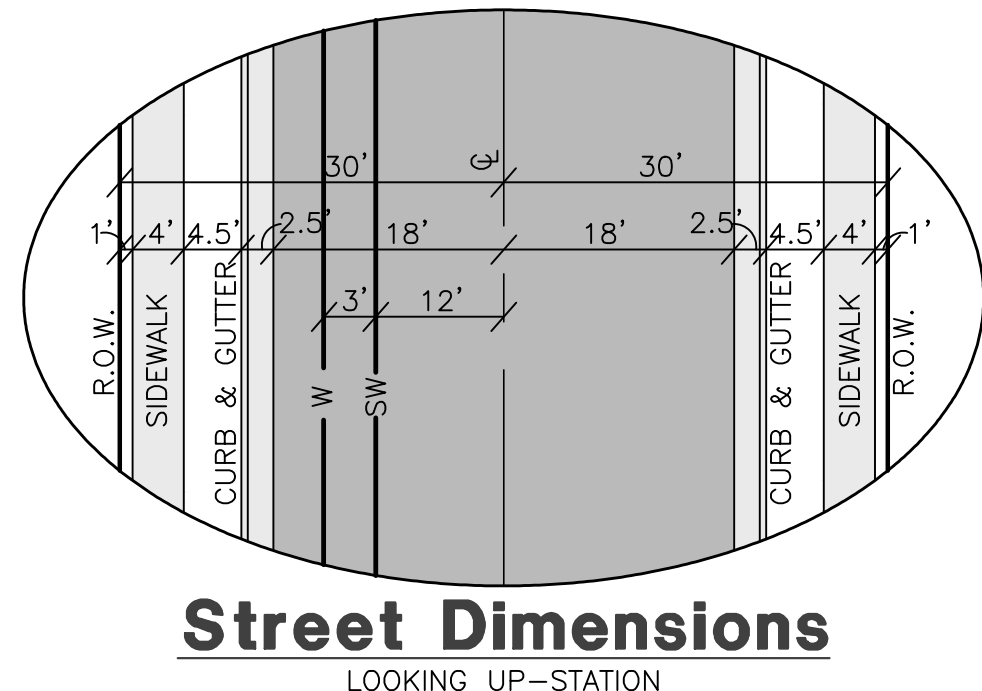

Centerline Curve Data

#	Delta	Radius	Length	Tangent	Chord	CH Length
C1	38°02'50"	150.00'	99.61'	51.72'	S17°27'11"E	97.79'

TBC Curve Data

#	Delta	Radius	Length	Tangent	Chord	CH Length
C3	38°02'50"	129.50'	85.99'	44.65'	N17°27'11"W	84.42'
C4	90°00'00"	20.00'	31.42'	20.00'	N46°34'14"E	28.28'
C5	90°00'00"	20.00'	31.42'	20.00'	S43°25'46"E	28.28'
C6	38°02'50"	170.50'	113.22'	58.79'	N17°27'11"W	111.15'



Revised: 07-12-16

Blue Stakes Location Center
Call: Toll Free
1-800-662-4111
 Two Working Days Before You Dig

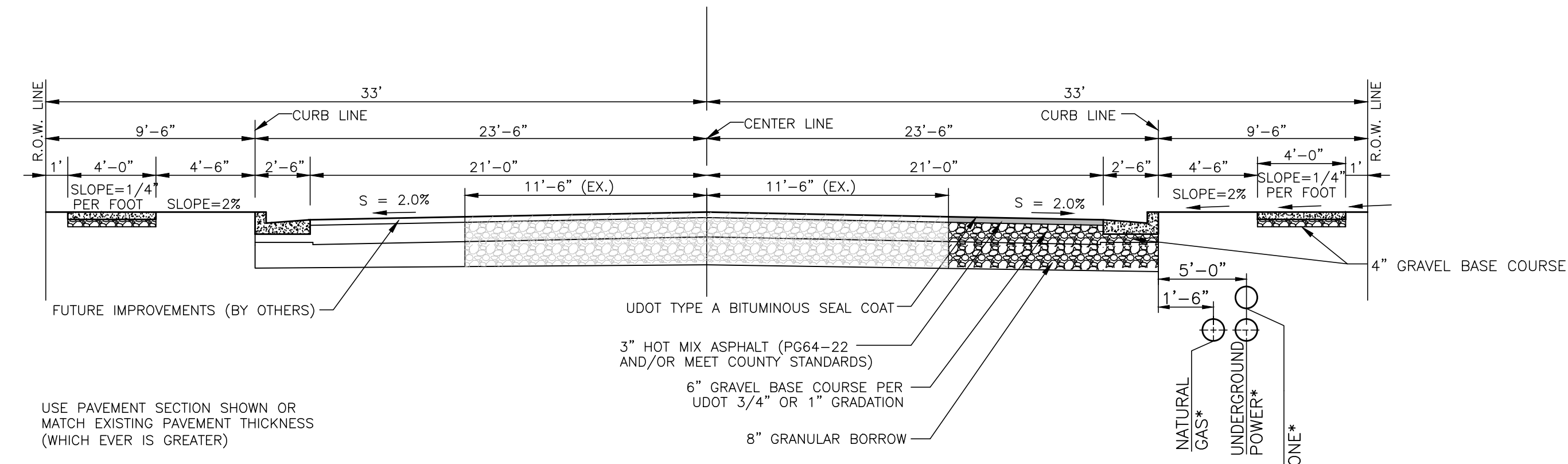
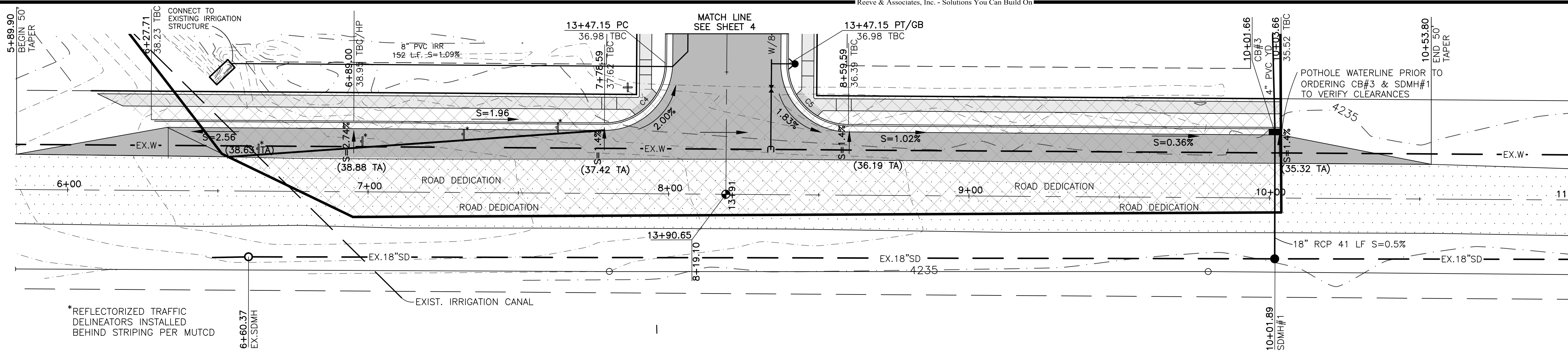

400 South Street Section (66' R.O.W.)
SCALE: NONE

*VERIFY LOCATION WITH PHONE, GAS AND POWER COMPANIES.

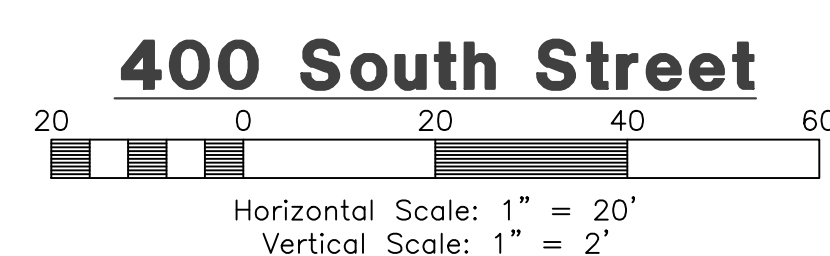

Key Map NOT TO SCALE

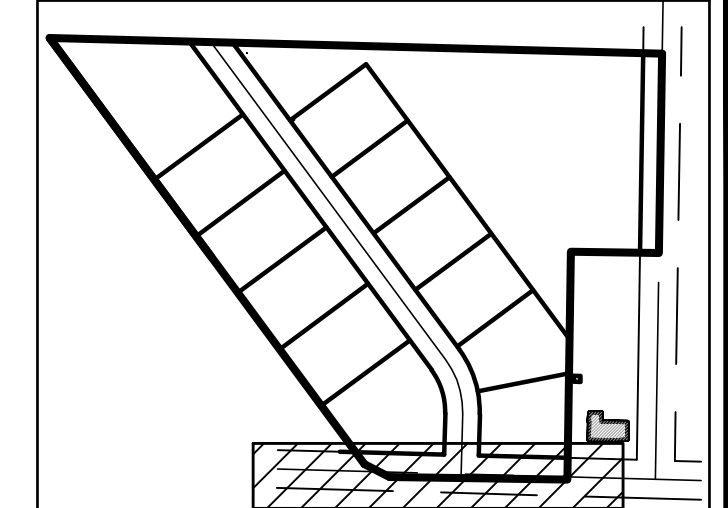

Construction Notes:

- ALL CONSTRUCTION IS TO CONFORM TO THE STANDARD DRAWINGS AND SPECIFICATIONS OF WEBER COUNTY & MANUAL OF STANDARD PLANS 2012 PUBLISHED BY APWA. WHEN IN CONFLICT, SEEK CLARIFICATION FROM WEBER COUNTY ENGINEERING DEPT.
- ALL STORM DRAIN PIPE IS TO HAVE TYPE 2 BEDDING, LESS THAN 500 LBS PER ACPA FILL HEIGHT CHARTS.

- CULINARY WATER**
W/8 - 8" PVC C-900 CLASS 200 WATER
W - 1" TYPE K COPPER SERVICE LATERAL
- SANITARY SEWER**
EACH LOT TO HAVE INDIVIDUAL SEPTIC LINE
- STORM DRAIN**
SD/18 - 18" RCP STORM DRAIN (CLASS III)
- SECONDARY WATER**
SW/6 - 6" PVC C-900 SECONDARY WATER LINE
IRR/8 - 8" ASTM D3034 SDR 35 IRRIGATION LINE
SW - (DOUBLE SERVICE) 1.5" CTS HDPE PIPE SERVICE LATERAL
SW - (SINGLE SERVICE) 1" CTS HDPE PIPE SERVICE LATERAL

TBC Curve Data

#	Delta	Radius	Length	Tangent	Chord	CH Length
C4	90°00'00"	20.00'	31.42'	20.00'	N46°34'14"E	28.28'
C5	90°00'00"	20.00'	31.42'	20.00'	S43°25'46"E	28.28'

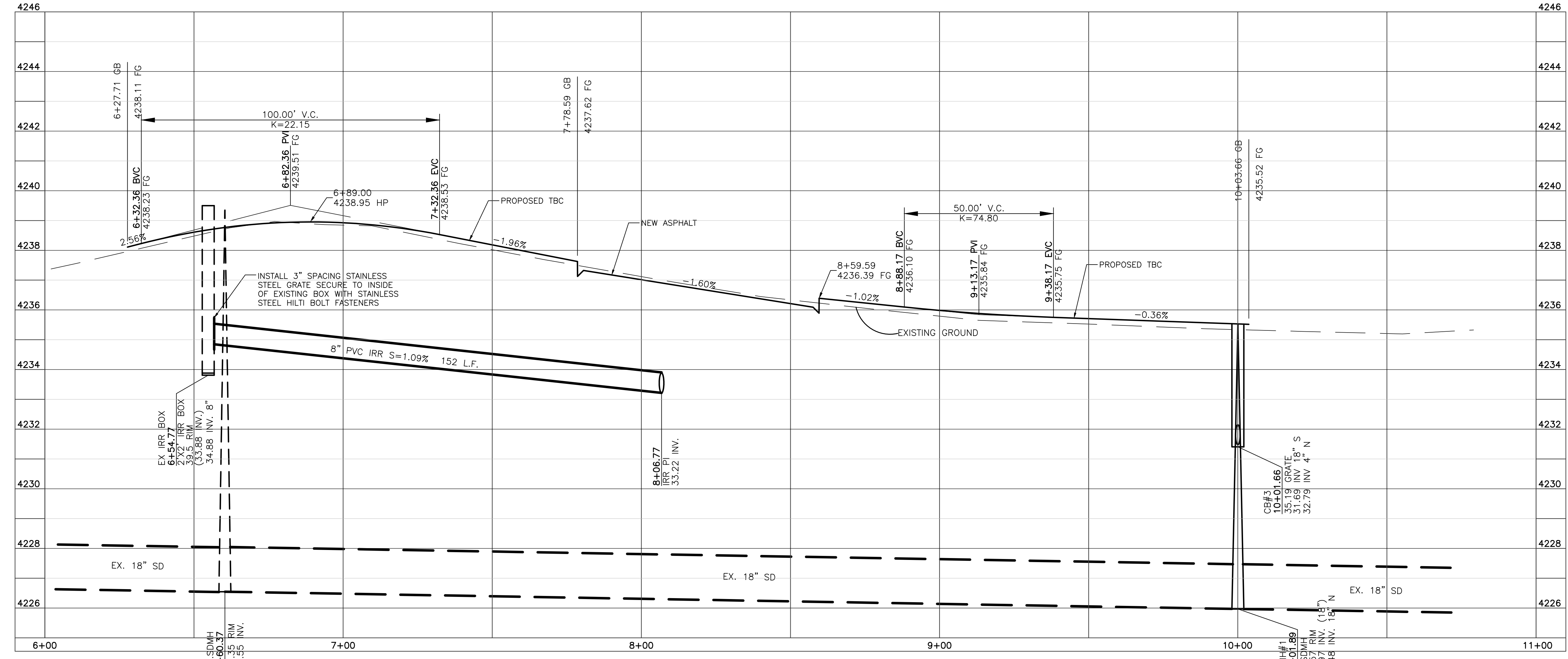

Blue Stakes Location Center
Call: Toll Free 1-800-662-4111
Two Working Days Before You Dig

Reeve & Associates, Inc.
920 CHAMBERS STREET, SUITE 14, OGDEN, UTAH 84403
TEL: (801) 621-2100 FAX: (801) 621-2666 WWW.REEVE-ASSOC.COM
LAND PLANNERS • CIVIL ENGINEERS • LAND SURVEYORS
TRAFFIC ENGINEERS • STRUCTURAL ENGINEERS • LANDSCAPE ARCHITECTS

REVISIONS	DESCRIPTION	DATE

Henry Flats Cluster Subdivision
WEST WEBER CITY, WEBER COUNTY, UTAH
400 South Street
6+00.00 - 11+00.00

Revised: 07-12-16

Project Info.
Engineer: J. NATE REEVE
Drafted: C. KINGSLEY
Begin Date: NOVEMBER, 2015
Name: HENRY FLATS CLUSTER SUBDIVISION
Number: 6272-01

Sheet **5** of **12** Sheets

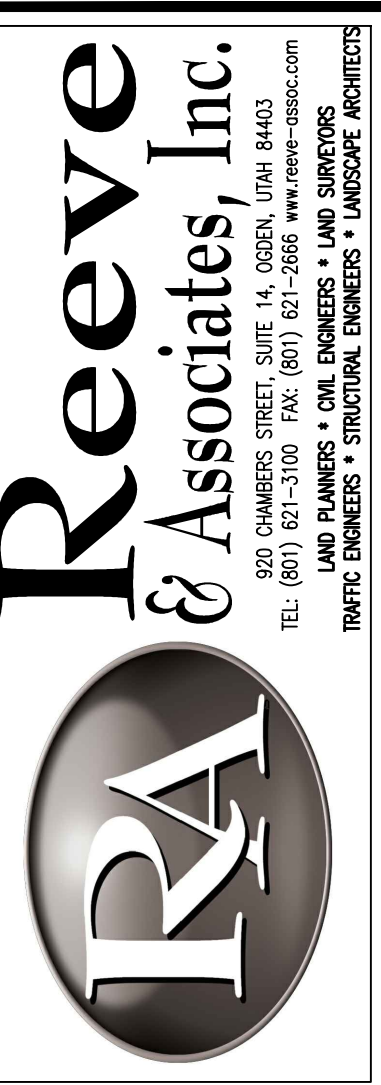
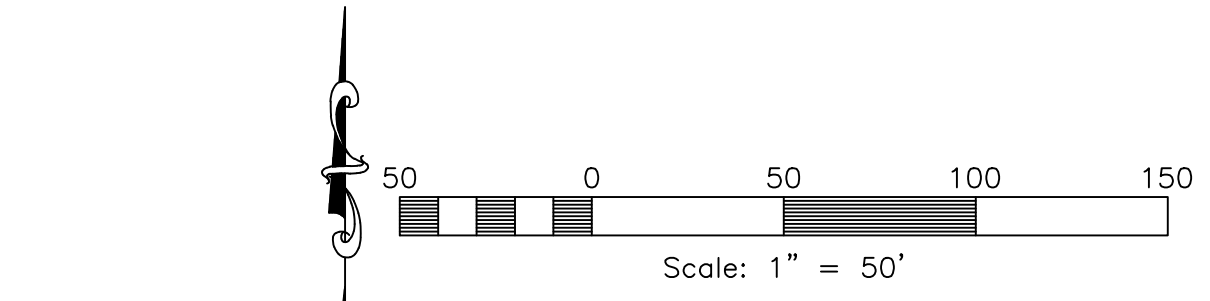
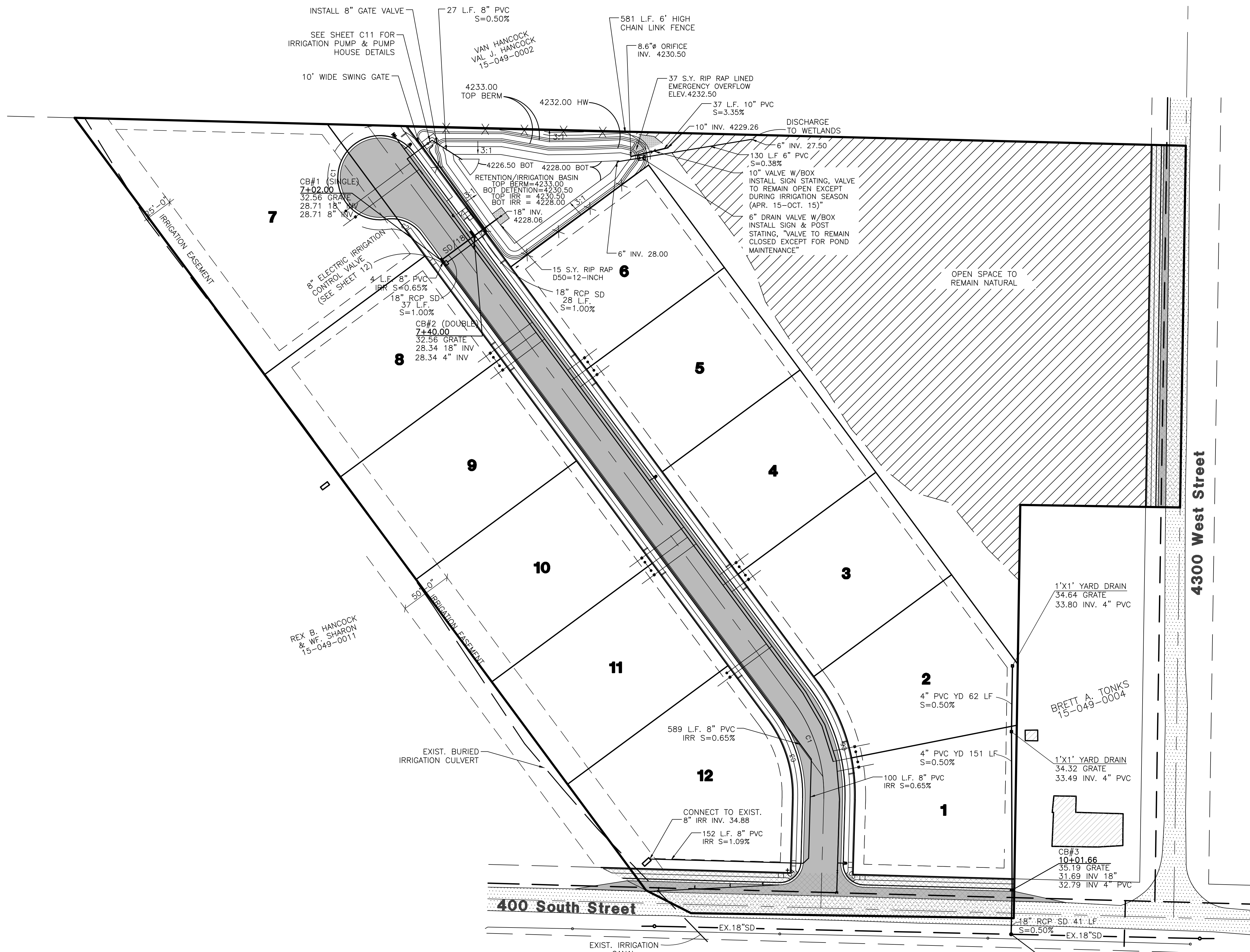

REVISIONS	DESCRIPTION
DATE	

Henry Flats Cluster Subdivision
WEST WEBER CITY, WEBER COUNTY, UTAH
Master Utility Plan

Revised: 07-12-16

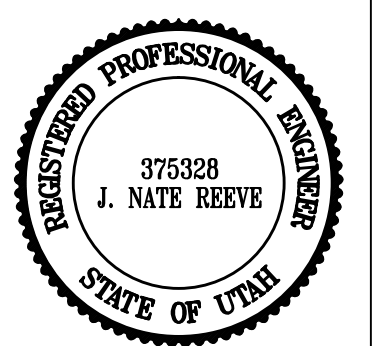

Project Info.

Engineer:	J. NATE REEVE
Drafter:	C. KINGSLEY
Begin Date:	NOVEMBER, 2015
Name:	HENRY FLATS CLUSTER SUBDIVISION
Number:	6272-01

Sheet	12
6	Sheets

REVISIONS	DESCRIPTION
DATE	

Henry Flats Cluster Subdivision
 WEST WEBER CITY, WEBER COUNTY, UTAH
Master Grading Plan

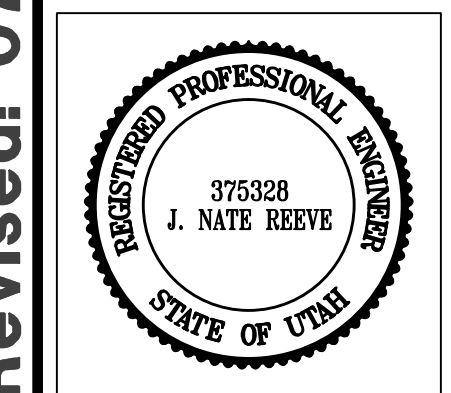

Project Info.
 Engineer: J. NATE REEVE
 Drafter: C. KINGSLEY
 Begin Date: NOVEMBER, 2015
 Name: HENRY FLATS CLUSTER SUBDIVISION
 Number: 6272-01

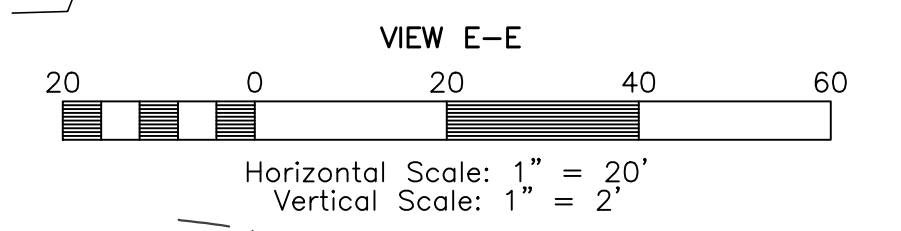
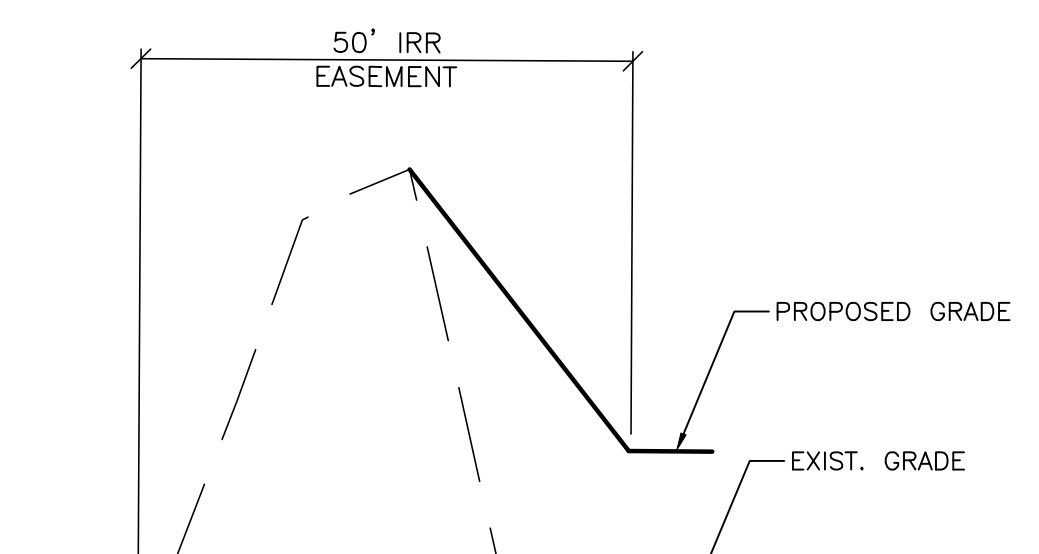
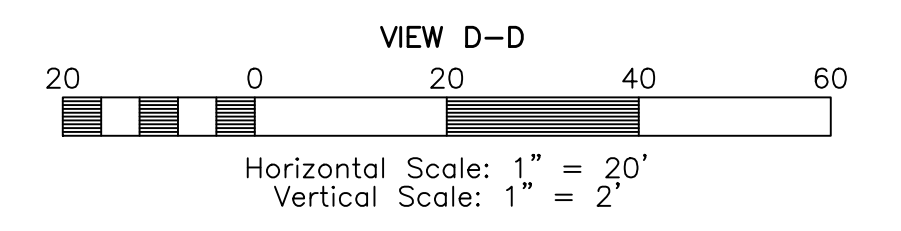
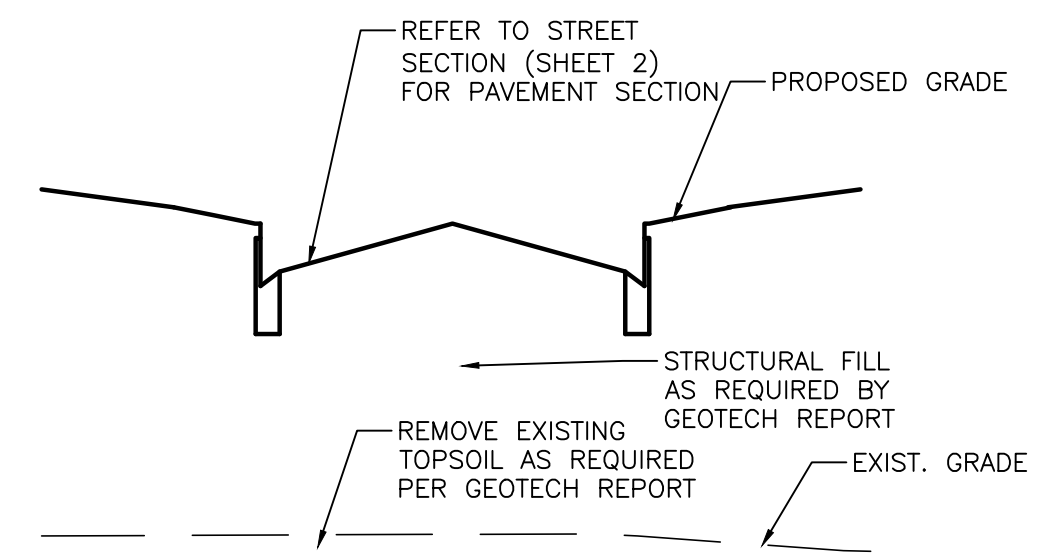
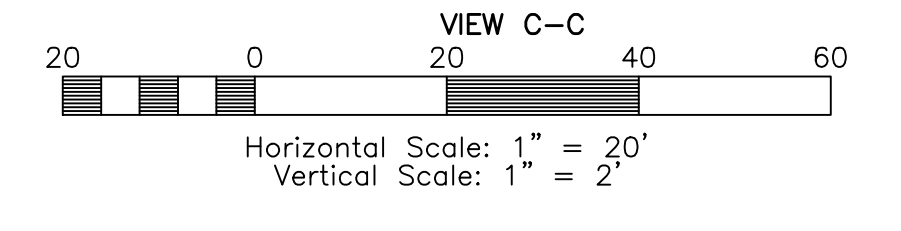
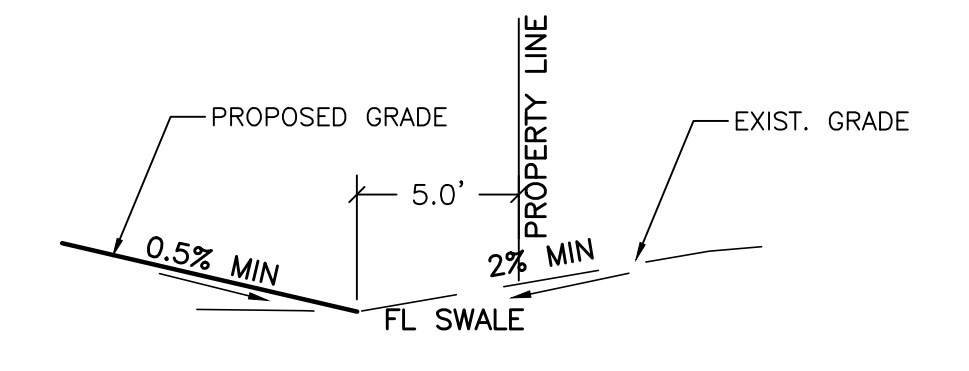
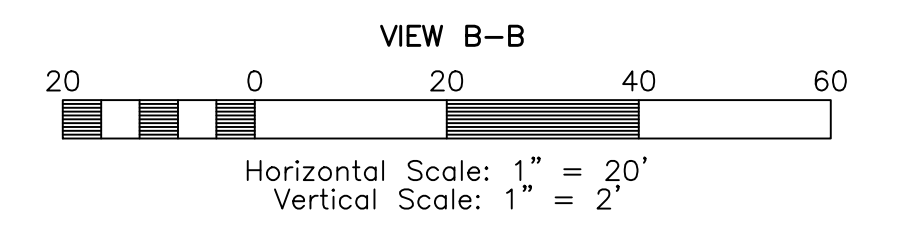
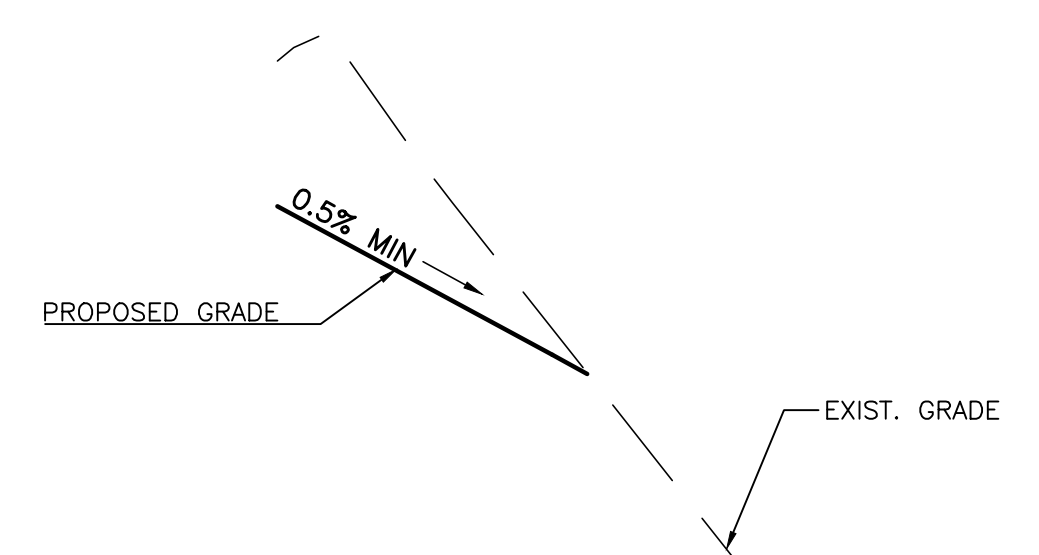
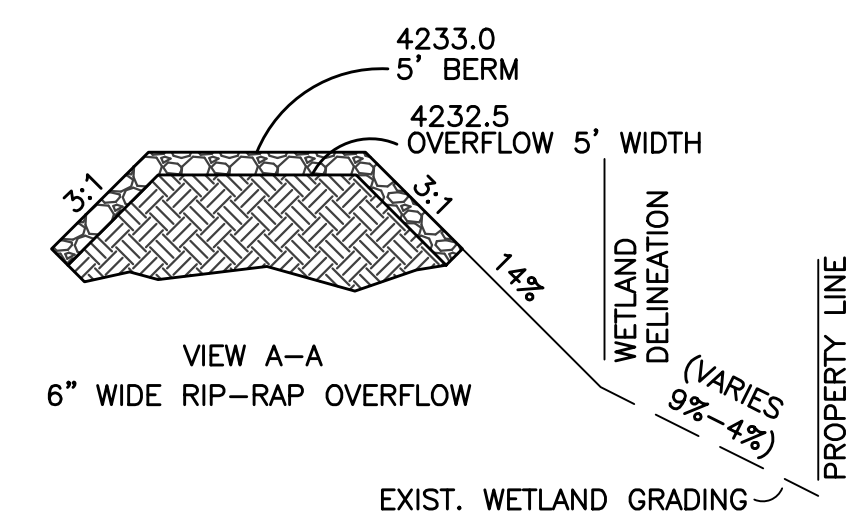
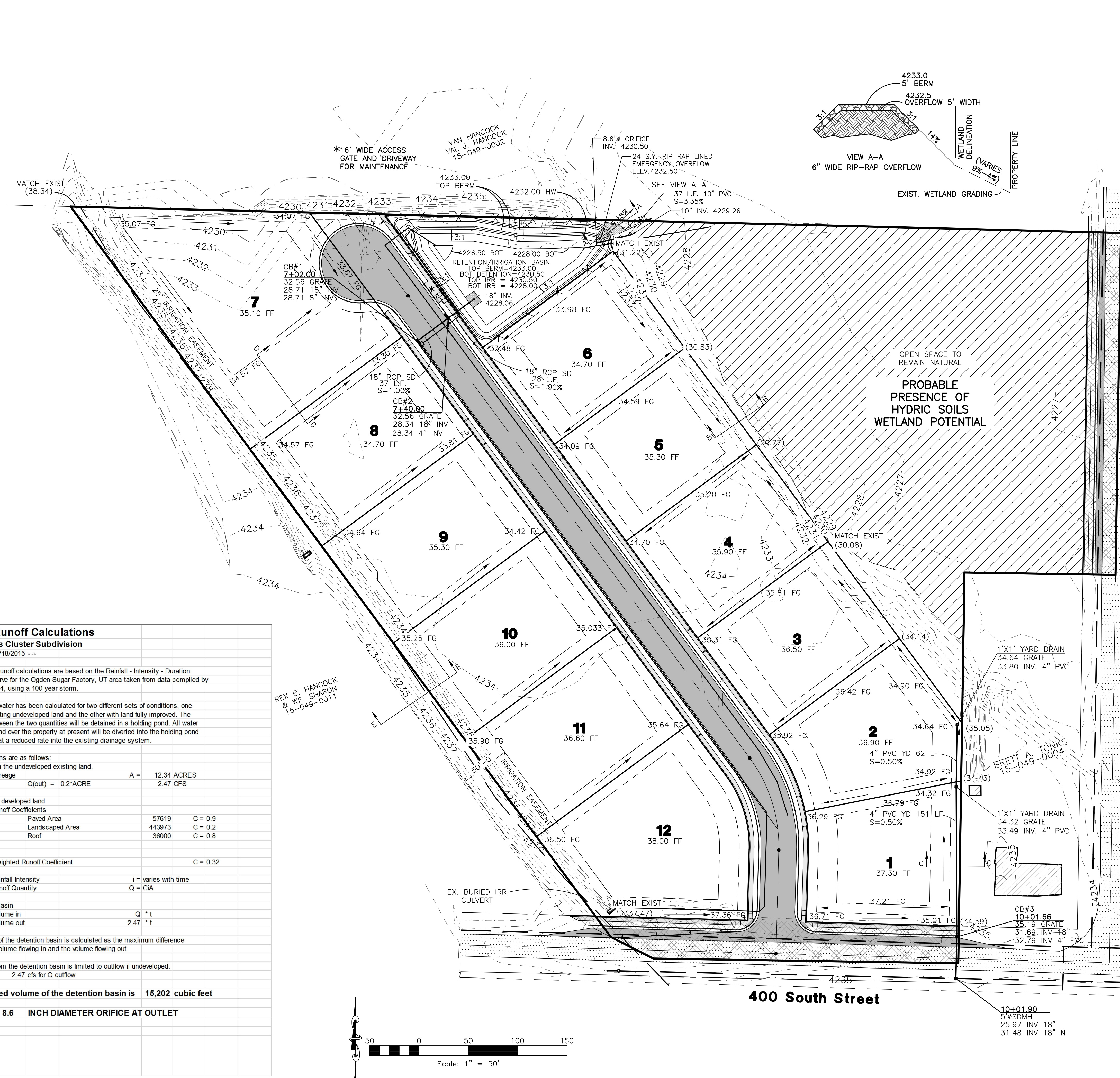

Storm Runoff Calculations
Henry Flats Cluster Subdivision
 11/18/2015 v.01

The following runoff calculations are based on the Rainfall - Intensity - Duration Frequency Curve for the Ogden Sugar Factory, UT area taken from data compiled by NOAA Atlas 14, using a 100 year storm.

Runoff storm water has been calculated for two different sets of conditions, one being the existing undeveloped land and the other with land fully improved. The difference between the two quantities will be detained in a holding pond. All water that runs off and over the property at present will be diverted into the holding pond and released at a reduced rate into the existing drainage system.

The calculations are as follows:

- Runoff from the undeveloped existing land.

Acreage	Q(out) = 0.2*ACRE	A = 12.34 ACRES
		2.47 CFS
- Runoff from developed land

Runoff Coefficients		
Paved Area	57619	C = 0.9
Landscaped Area	443973	C = 0.2
Roof	36000	C = 0.8
Weighted Runoff Coefficient		C = 0.32
Rainfall Intensity	i = varies with time	
Runoff Quantity	Q = CIA	
- Detention Basin

Volume in	Q * t
Volume out	2.47 * t

The capacity of the detention basin is calculated as the maximum difference between the volume flowing in and the volume flowing out.

The outflow from the detention basin is limited to outflow if undeveloped.
 Use 2.47 cfs for Q outflow

The required volume of the detention basin is 15,202 cubic feet

USE A 8.6 INCH DIAMETER ORIFICE AT OUTLET

Henry Flats Subdivision Phase 1

Storm Water Pollution Prevention Plan Exhibit

WEST WEBER CITY, WEBER COUNTY, UTAH
MARCH, 2016

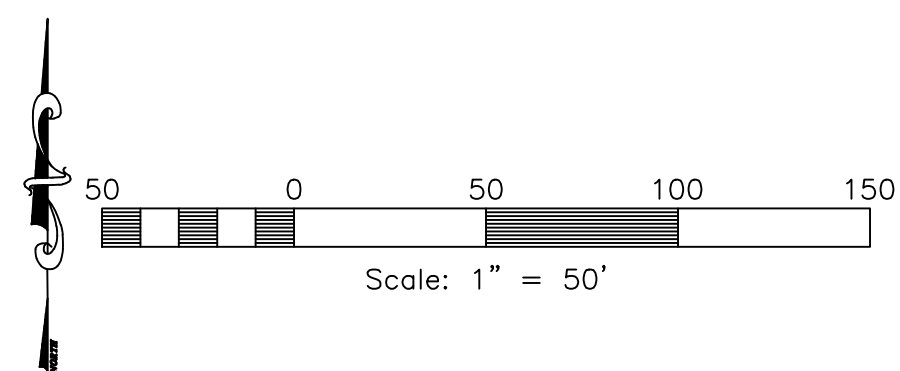
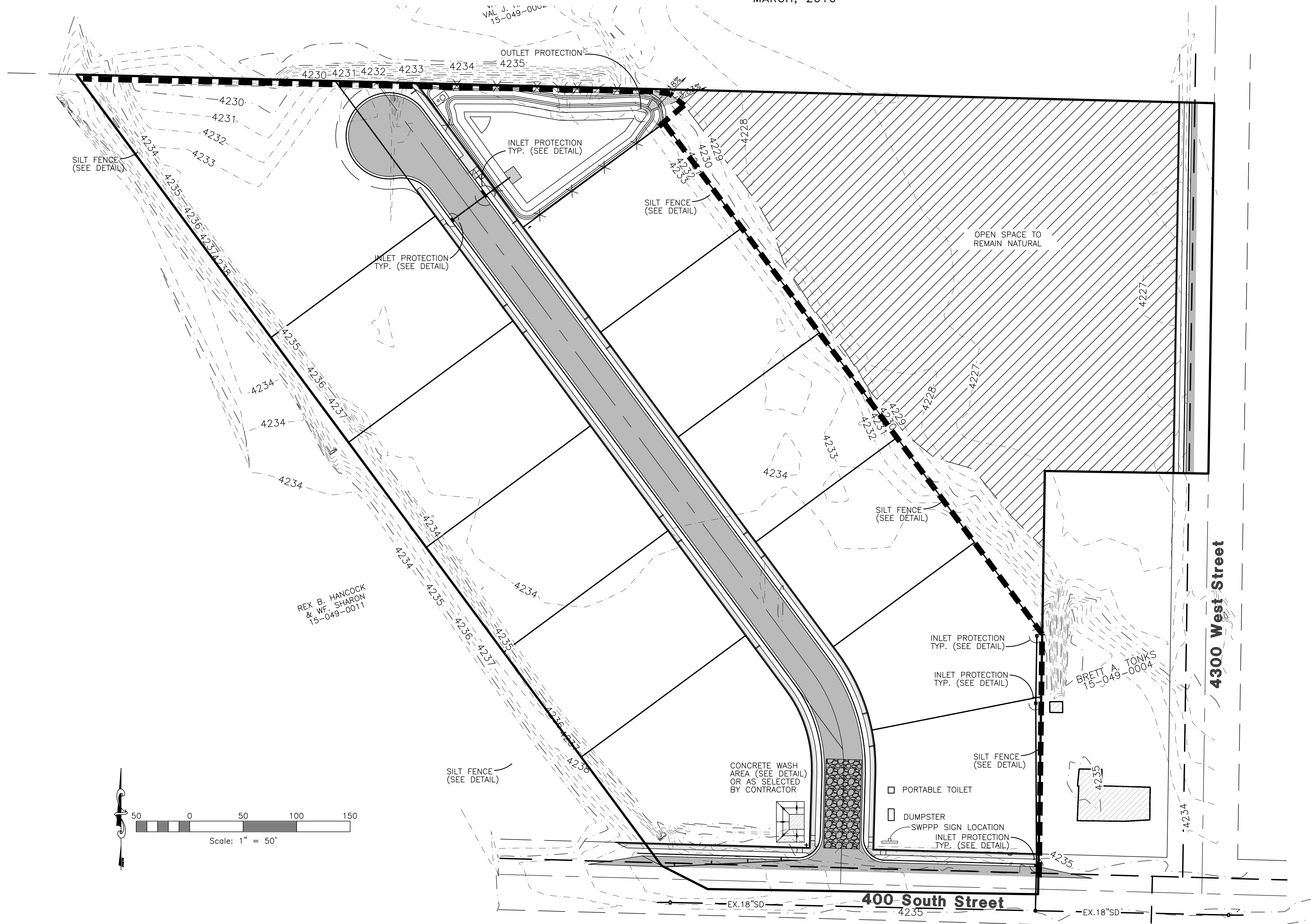

Vicinity Map
NOT TO SCALE

General Notes

1. CONTRACTOR IS REQUIRED TO COMPLETE THE ASSOCIATED PAPERWORK, APPLICATION, AND SUBMITTAL OF THE SWPPP TO THE COUNTY FOR A STORM WATER CONSTRUCTION ACTIVITY PERMIT WITH THE FOLLOW-UP APPLICATION TO THE UTAH STATE DIVISION OF WATER QUALITY (DWRQ) FOR OBTAINING AN NOI.
2. THE CURRENT CONSTRUCTION GENERAL PERMIT REQUIRES EROSION PREVENTION, SEDIMENT CONTAINMENT, INLET PROTECTION, GOOD HOUSEKEEPING AND POST CONSTRUCTION STABILIZATION.
3. SILT FENCE TO REMAIN UNTIL LANDSCAPING HAS BEEN INSTALLED FOR LOT & BASIN IMPROVEMENTS.

STREETS TO BE SWEEPED WITHIN 1000 FEET OF CONSTRUCTION ENTRANCE DAILY IF NECESSARY.
ALL VEHICLES EXITING SITE TO PROCEED THROUGH CONSTRUCTION ENTRANCE TO REDUCE AMOUNTS OF SEDIMENT TRACKED ONTO ROADWAYS.
50'x20' CONSTRUCTION ENTRANCE W/8" COMPACTED CLEAN GRAVEL CONTRACTOR REQUIRED TO PREVENT TRACK OUT AND BACK UP SUPPORT FOR STREET SWEEPING.

Construction Activity Schedule	
- PROJECT LOCATION.....	WEST WEBER CITY, WEBER COUNTY, UTAH
- PROJECT BEGINNING DATE.....	MARCH 2016
- BMP'S DEPLOYMENT DATE.....	MARCH 2016
- STORM WATER MANAGEMENT CONTACT / INSPECTOR.....	TBD
- SPECIFIC CONSTRUCTION SCHEDULE INCLUDING BMP CONSTRUCTION SCHEDULE TO BE INCLUDED WITH SWPPP BY OWNER/DEVELOPER	

Reeve & Associates, Inc. - Solutions You Can Build On

Reeve & Associates, Inc.
 920 CHAMBERS STREET, SUITE 14, OGDEN, UTAH 84403
 TEL: (801) 621-2100 FAX: (801) 621-2666 www.reeve-assoc.com
 LAND PLANNERS • CIVIL ENGINEERS • LAND SURVEYORS
 TRAFFIC ENGINEERS • STRUCTURAL ENGINEERS • LANDSCAPE ARCHITECTS



REVISIONS	DESCRIPTION

Henry Flats Cluster Subdivision
 WEST WEBER CITY, WEBER COUNTY, UTAH
Storm Water Pollution Prevention Plan Exhibit



Project Info.	
Engineer:	J. NATE REEVE
Drafter:	C. KINGSLEY
Begin Date:	NOVEMBER, 2015
Name:	HENRY FLATS CLUSTER SUBDIVISION
Number:	6272-01

Sheet	12
8	Sheets

Notes:

- Describe all BMP's to protect storm water inlets:
All storm water inlets to be protected by straw wattle barriers, or gravel bags (see detail).
- Describe BMP's to eliminate/reduce contamination of storm water from:
 - Equipment / building / concrete wash areas:
To be performed in designated areas only and surrounded with silt fence barriers.
 - Soil contaminated by soil amendments:
If any contaminants are found or generated, contact environmental engineer and contacts listed.
 - Areas of contaminated soil:
If any contaminants are found or generated, contact environmental engineer and contacts listed.
 - Fueling area:
To be performed in designated areas only and surrounded with silt fence.
 - Vehicle maintenance areas:
To be performed in designated areas only and surrounded with silt fence.
 - Vehicle parking areas:
To be performed in designated areas only and surrounded with silt fence.
 - Equipment storage areas:
To be performed in designated areas only and surrounded with silt fence.
 - Materials storage areas:
To be performed in designated areas only and surrounded with silt fence.
 - Waste containment areas:
To be performed in designated areas only and surrounded with silt fence. All dumpsters or trash containers shall be covered and no fluids shall be placed therein.
 - Service areas:
To be performed in designated areas only and surrounded with silt fence.
- BMP's for wind erosion:
Stockpiles and site as needed to be watered regularly to eliminate / control wind erosion
- Construction Vehicles and Equipment:
 - Maintenance
 - Maintain all construction equipment to prevent oil or other fluid leaks.
 - Keep vehicles and equipment clean, prevent excessive build-up of oil and grease.
 - Regularly inspect on-site vehicles and equipment for leaks, and repair immediately.
 - Check incoming vehicles and equipment (including delivery trucks, and employee and subcontractor vehicles) for leaking oil and fluids. Do not allow leaking vehicles or equipment on-site.
 - Segregate and recycle wastes, such as greases, used oil or oil filters, antifreeze, cleaning solutions, automotive batteries, hydraulic, and transmission fluids.
 - No liquid waste shall be poured out onto the ground or to any drain but disposed of in a proper legal manner.
 - Fueling
 - If fueling must occur on-site, use designated areas away from drainage.
 - Locate on-site fuel storage tanks within a bermed area designed to hold the tank volume.
 - Cover retention area with an impervious material and install in a manner to ensure that any spills will be contained in the retention area. To catch spills or leaks when removing or changing fluids.
 - Use drip pans for any oil or fluid changes.
 - Remove and dispose of any contaminated soils resulting from fuel spillage in the legal and proper manner.
 - Washing
 - Use as little water as possible to avoid installing erosion and sediment controls for the wash area.
 - If washing must occur on-site, use designated, bermed wash areas to prevent waste water discharge into storm water, creeks, rivers, and other water bodies.
 - Do not permit steam cleaning on-site.
 - No discharge of wash water containing soaps, detergents or solvents shall be allowed onsite.
- Spill Prevention and Control
 - Minor Spills:
Minor spills are those which are likely to be controlled by on-site personnel. After contacting local emergency response agencies, the following actions should occur upon discovery of a minor spill:
 - Contain the spread of the spill.
 - If the spill occurs on paved or impermeable surfaces, clean up using "dry" methods (i.e. absorbent materials, cat litter, and / or rags).
 - If the spill occurs in dirt areas, immediately contain the spill by constructing an earth dike. Dig up & properly dispose of contaminated soil.
 - If the spill occurs during rain, cover the impacted area to avoid runoff.
 - Record all steps taken to report and contain spill.
 - Major Spills:
On-site personnel should not attempt to control major spills until the appropriate and qualified emergency response staff have arrived at the site. For spills of federal reportable quantities, also notify the National Response Center at (800) 424-8802. A written report should be sent to all notified authorities. Failure to report major spills can result in significant fines and penalties.
- Post Roadway / Utility Construction
 - Maintain good housekeeping practices.
 - Enclose or cover building material storage areas.
 - Properly store materials such as paints and solvents.
 - Store dry and wet materials under cover, away from drainage areas.
 - Avoid mixing excess amounts of fresh concrete or cement on-site.
 - Perform washout of concrete trucks offsite or in designated areas only. Washouts must be emptied when reaching 75% of being filled.
 - Do not wash out concrete trucks into storm drains, open ditches, streets or streams.
 - Do not place material or debris into streams, gutters or catch basins that stop or reduce the flow of runoff water.
 - All public streets and storm drain facilities shall be maintained free of building materials, mud and debris caused by grading or construction operations. Roads will be swept within 1000' of construction entrance daily, if necessary.
 - Install straw wattle around all inlets contained within the development and all others that receive runoff from the development.
- Storm Water Pollution Prevention Plan (SWPPP) Notes
 - The contractor will designate an emergency contact that can be reached 24 hours a day 7 days a week.
 - A stand-by crew for emergency work shall be available at all times during potential rain or snow runoff events. Necessary materials shall be available on site and stockpiled at convenient locations to facilitate rapid construction of emergency devices when rain or runoff is eminent.
 - Erosion control devices shown on the plans and approved for the project may not be removed without approval of the engineer of record. If devices are removed, no work may continue that have the potential of erosion without consulting the engineer of record. If deemed necessary erosion control shall be reestablished before the work recommences.
 - Graded areas adjacent to fill slopes located at the site perimeter must drain away from the top of the slope at the conclusion of each working day. This should be confirmed by survey or other means acceptable to the engineer of record.
 - All silt and debris shall be removed from all devices within 24 hours after each rain or runoff event.
 - Except as otherwise approved by the inspector, all removable protective devices shown shall be in place at the end of each working day and through weekends until removal of the system is approved.
 - All loose soil and debris, which may create a potential hazard to offsite property, shall be removed from the site as directed by the Engineer of record using a SWPPP amendment.
 - The placement of additional devices to reduce erosion damage within the site is left to the discretion of the Engineer of record.
 - Desilting basins may not be removed or made inoperable without the approval of the engineer of record and the governing agency.
 - Erosion control devices will be modified as needed as the project progresses, and plans of these changes submitted for approval by the engineer of record and the governing agency using a SWPPP amendment.
- Conduct a minimum of one inspection of the erosion and sediment controls every two weeks. Maintain documentation on site.
 - Part III.D.4 of general permit UTR300000 identifies the minimum inspection requirements.
 - Part II.D.4.C identifies the minimum inspection report requirements.
 - Failure to complete and/or document storm water inspections is a violation of part III.D.4 of Utah General Permit UTR 300000.
- Portable toilets shall be set back a minimum of 10 feet from the back of any curb line and/or 10 feet from any storm drain inlet. All portable toilets shall be properly staked to prevent tip over or spillage.

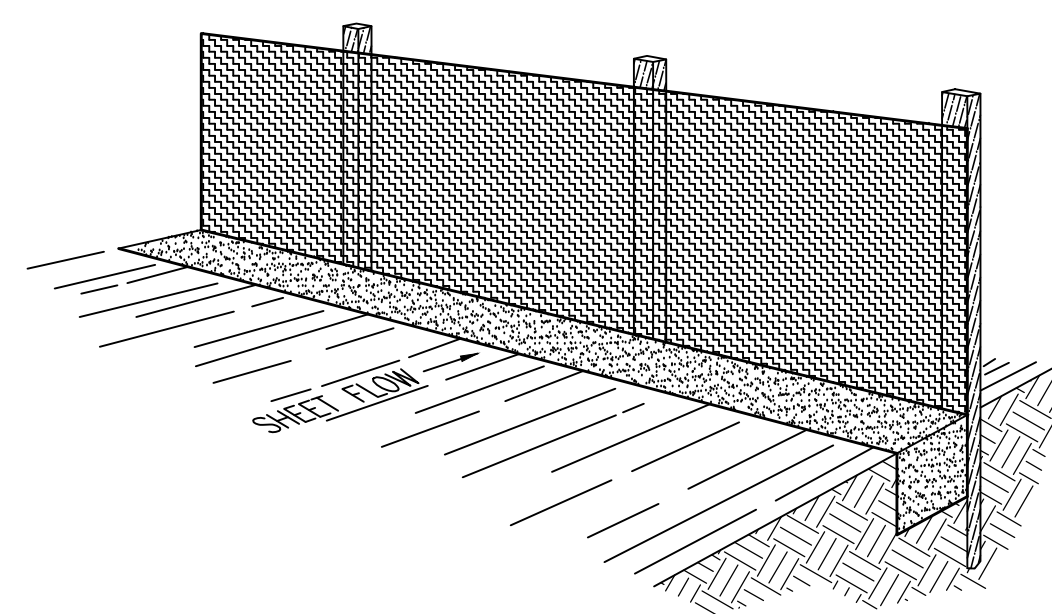

Perspective View

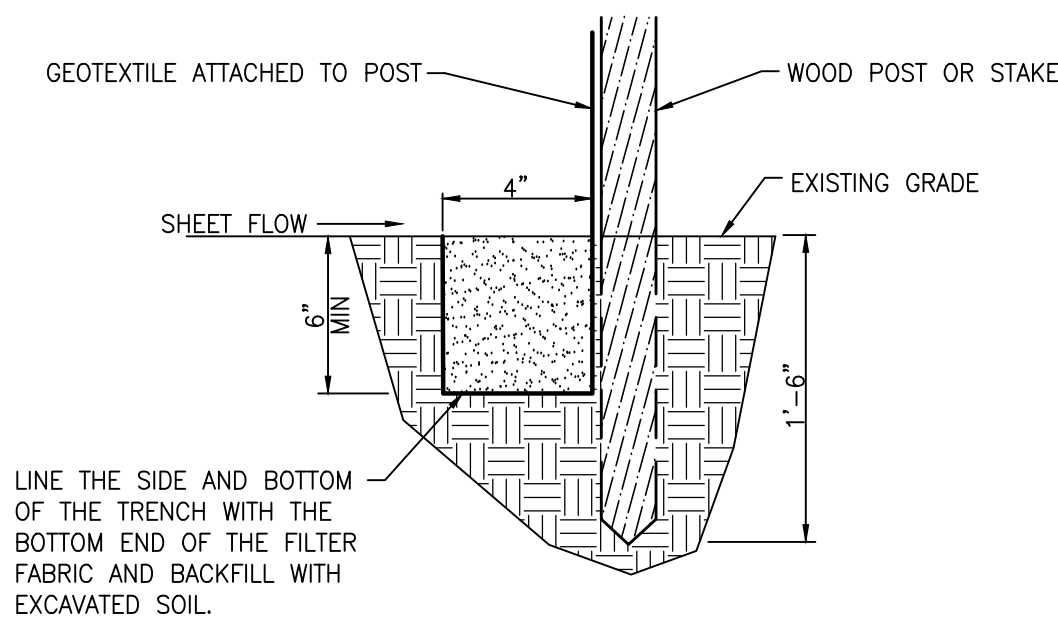

Section

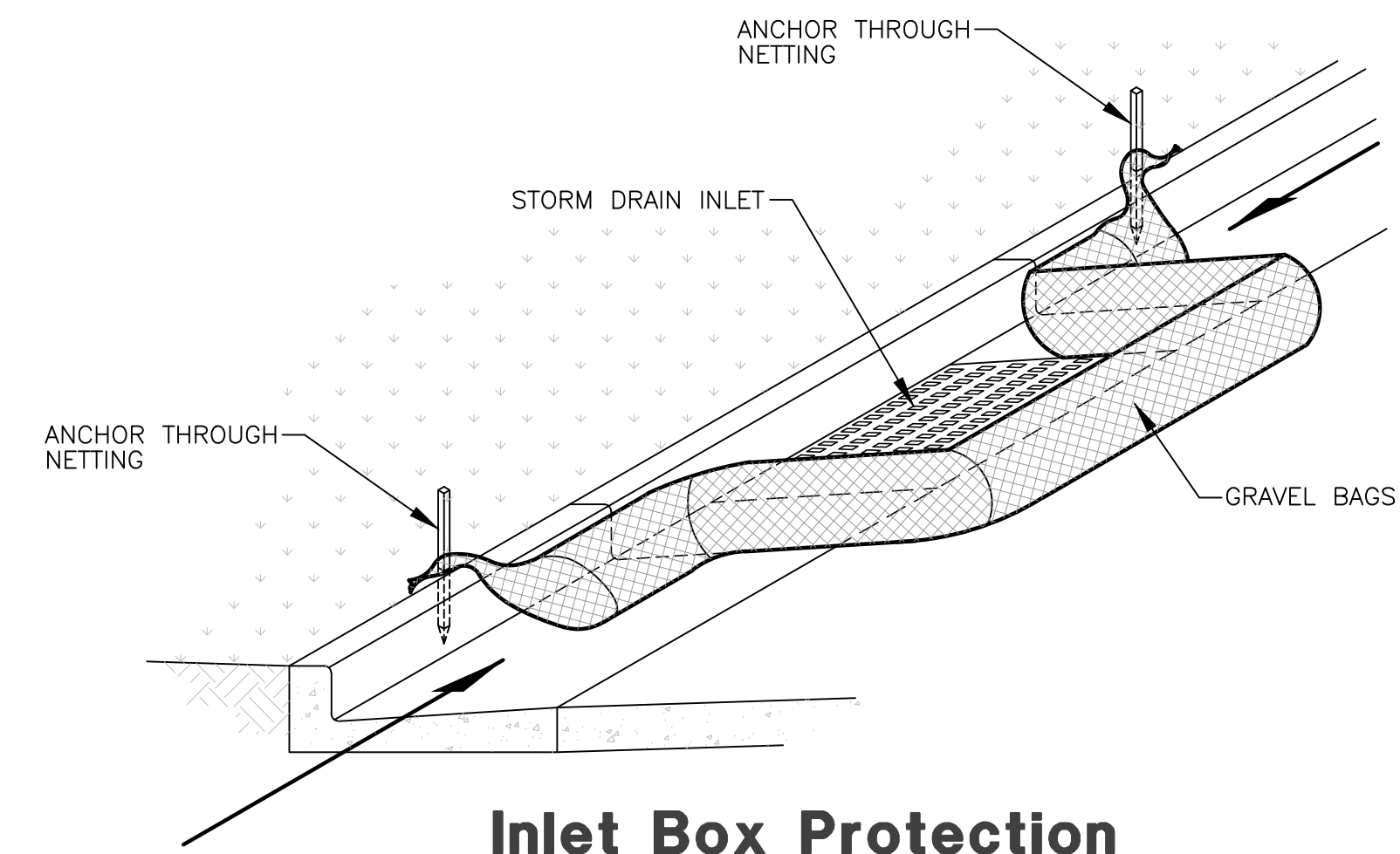

Inlet Box Protection

INSTALLATION

The silt fence should be installed prior to major soil disturbances in the drainage area. The fence should be placed across the slope along a line of uniform elevation wherever flow of sediment is anticipated. Table 1 shows generally-recommended maximum slope lengths (slope spacing between fences) at various site grades for most silt fence applications.

Slope Steepness (%)	Max. Slope Length (m (ft))
<2%	30.5m (100ft)
2-5%	22.9m (75ft)
5-10%	15.2m (50ft)
10-20%	7.6m (25ft)
>20%	4.5m (15ft)

PREFABRICATED SILT FENCE ROLLS

- Excavate a minimum 15.2cm x 15.2cm (6"x6") trench at the desired location.
- Unroll the silt fence, positioning the post against the downstream wall of the trench.
- Adjacent rolls of silt fence should be joined by nesting the end post of one fence into the other. Before nesting the end posts, rotate each post until the geotextile is wrapped completely around the post, then abut the end posts to create a tight seal as shown in Figure 1.
- Drive posts into the ground until the required fence height and/or anchorage depth is obtained.
- Bury the loose geotextile at the bottom of the fence in the upstream trench and backfill with natural soil, tamping the backfill to provide good compaction and anchorage. Figure 2 illustrates a typical silt fence installation and anchor trench placement.

should generally be less than three (3) times the height of the fence.
If a steel or plastic mesh is required to reinforce the geotextile, it shall have a minimum mesh opening of 15.2cm (6").
Fasten the mesh to the upslope side of the posts using heavy duty wire staples, tie wires or hog strings. Extend the mesh into the bottom of the trench.
The geotextile shall then be stapled or wired to the posts. An extra 20-50cm (8-20") of geotextile shall extend into the trench.

INSPECTION

Inspect the silt fence daily during periods of rainfall, immediately after significant rainfall event and weekly during periods of no rainfall. Make any repairs immediately.
When sediment deposits behind the silt fence are one-third of the fence height, remove and properly dispose of the silt accumulations. Avoid damage to the fabric during cleanup.

REMOVAL

Silt fence should not be removed until construction ceases and the upslope area has been properly stabilized and/or revegetated.

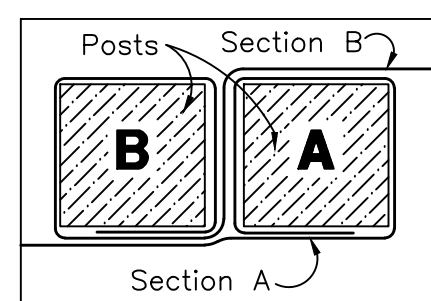
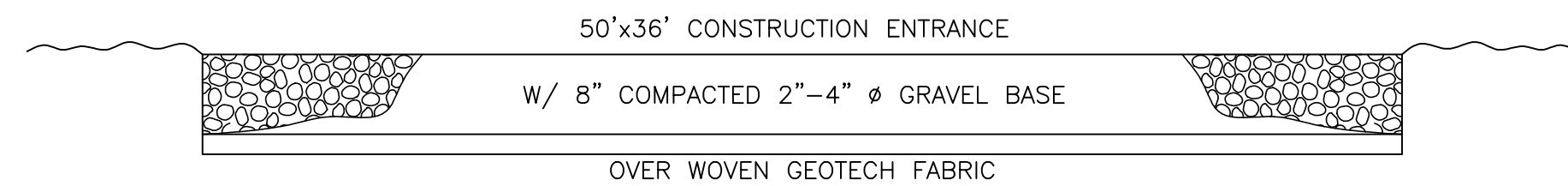
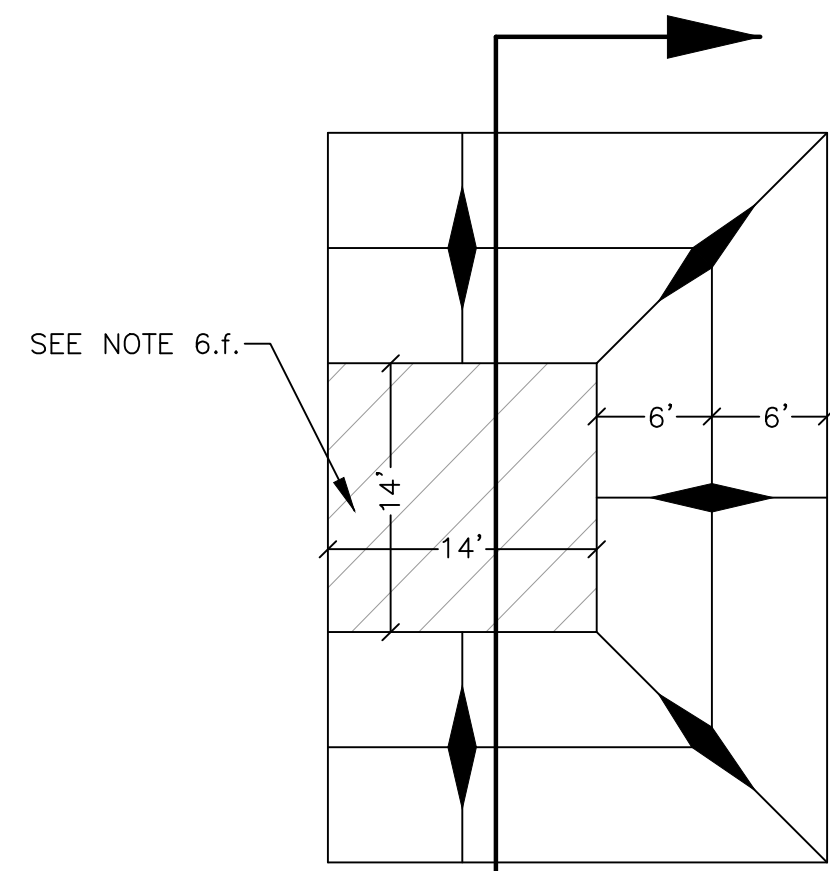
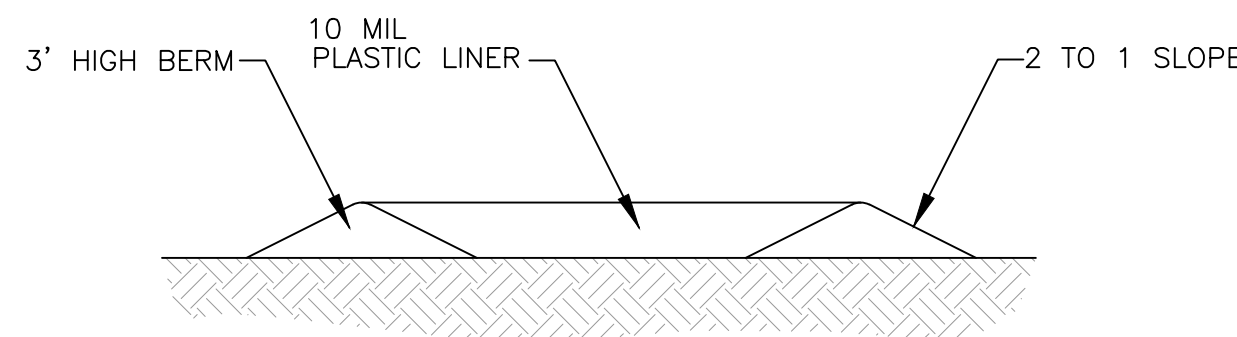

Figure 1:
Top View of
Roll-to-Roll Connection

Silt Fence Detail

SCALE: NONE



Cross Section 50' x 20' Construction Entrance

**Concrete Washout Area
w/ 10 mil Plastic Liner**

SCALE: NONE

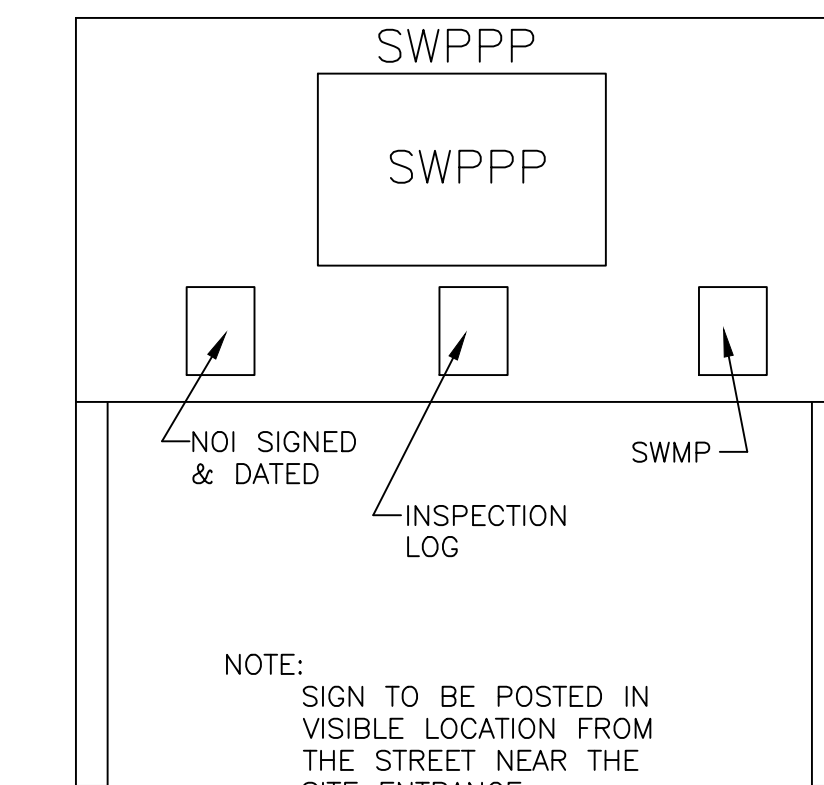

**Sample SWPPP Board
(4'x8' Sheet of Plywood)**

SCALE: NONE

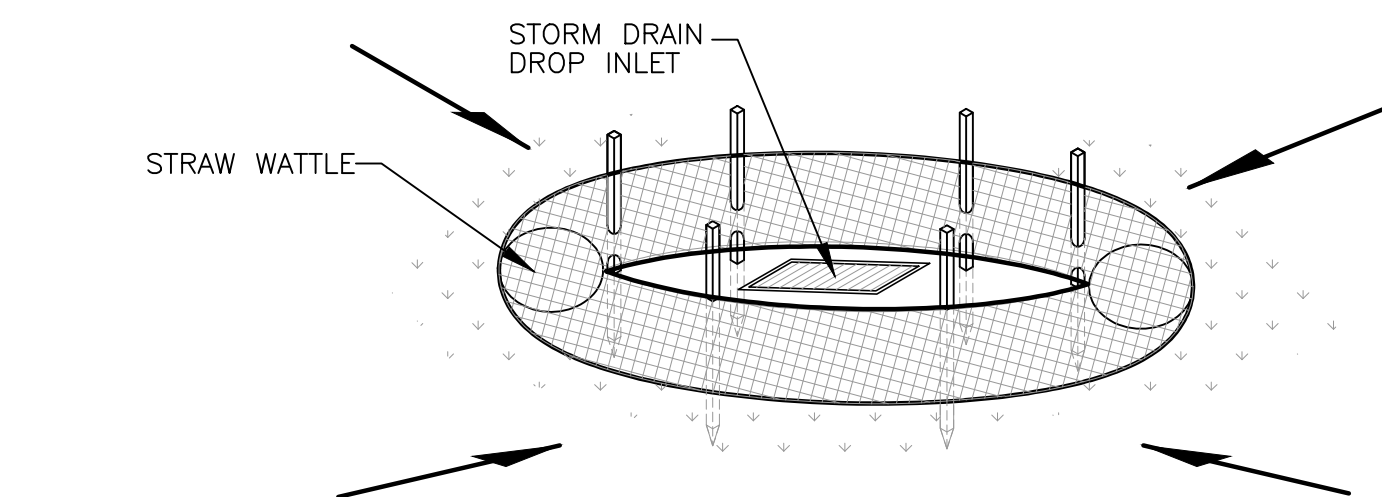

Drop Inlet Protection

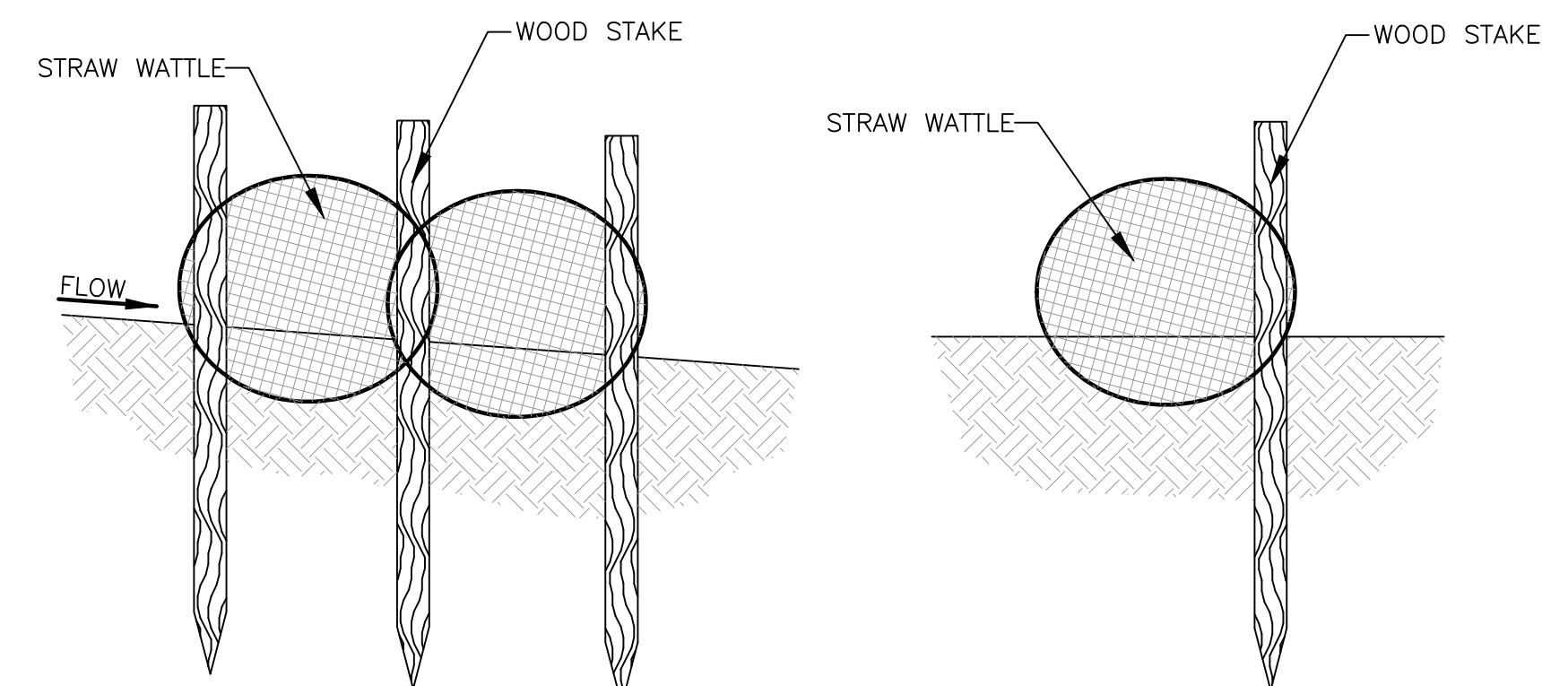

Stake Detail

Reeve & Associates, Inc.
920 CHAMBERS STREET, SUITE 14, OGDEN, UTAH 84403
TEL: (801) 921-2100 FAX: (801) 621-2668 www.reeve-assoc.com

IRA
LAND PLANNERS • CIVIL ENGINEERS • LAND SURVEYORS
INFRASTRUCTURE ENGINEERS • LANDSCAPE ARCHITECTS

REVISIONS	DESCRIPTION

Henry Flats Cluster Subdivision
WEST WEBER CITY, WEBER COUNTY, UTAH

**Storm Water Pollution
Prevention Plan Details**

REGISTERED PROFESSIONAL ENGINEER
375328
J. NATE REEVE
STATE OF UTAH

Project Info.
Engineer: J. NATE REEVE
 Drafter: C. KINGSLEY
Begin Date: NOVEMBER, 2015
Name: HENRY FLATS CLUSTER SUBDIVISION
Number: 6272-01

Sheet **12**
9 Sheets

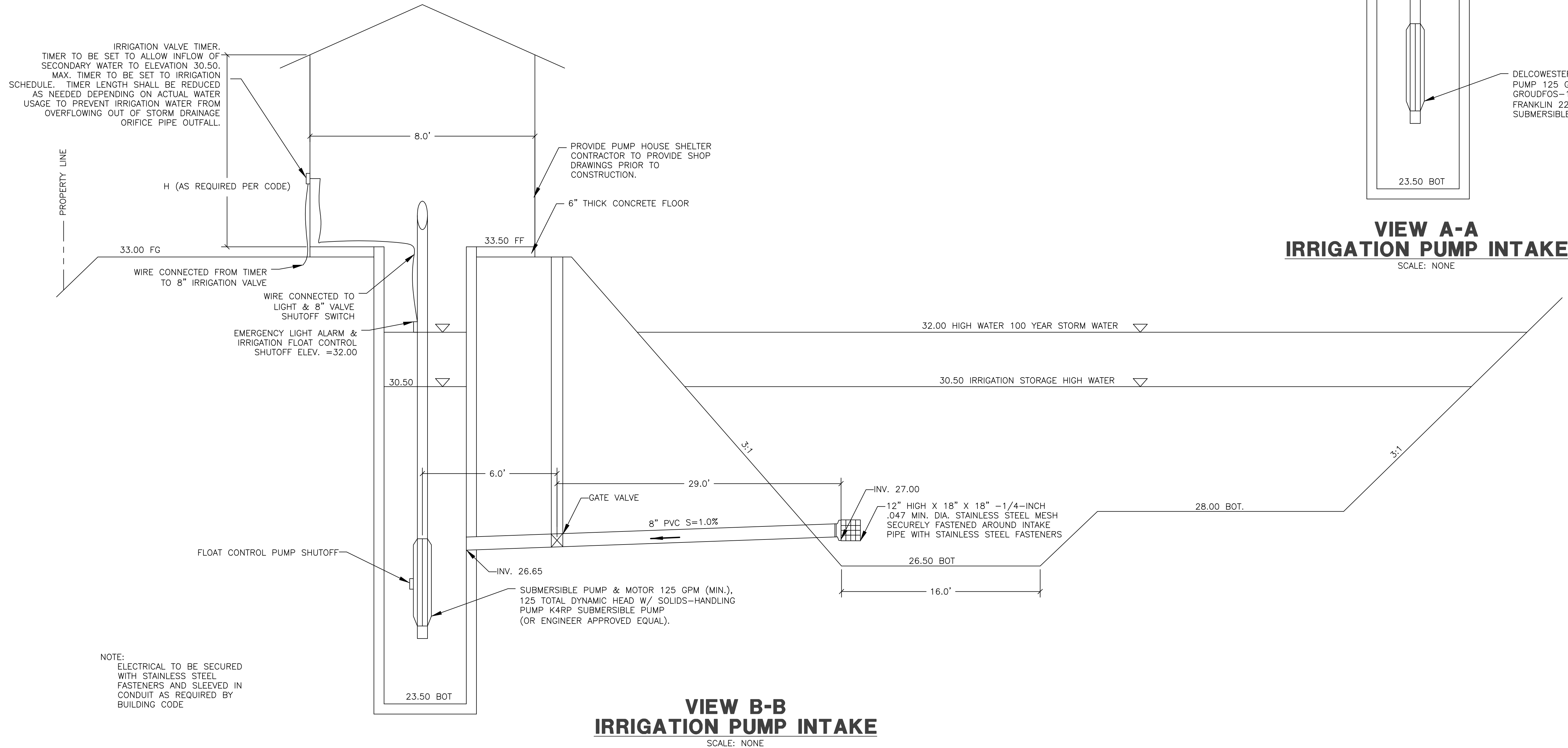
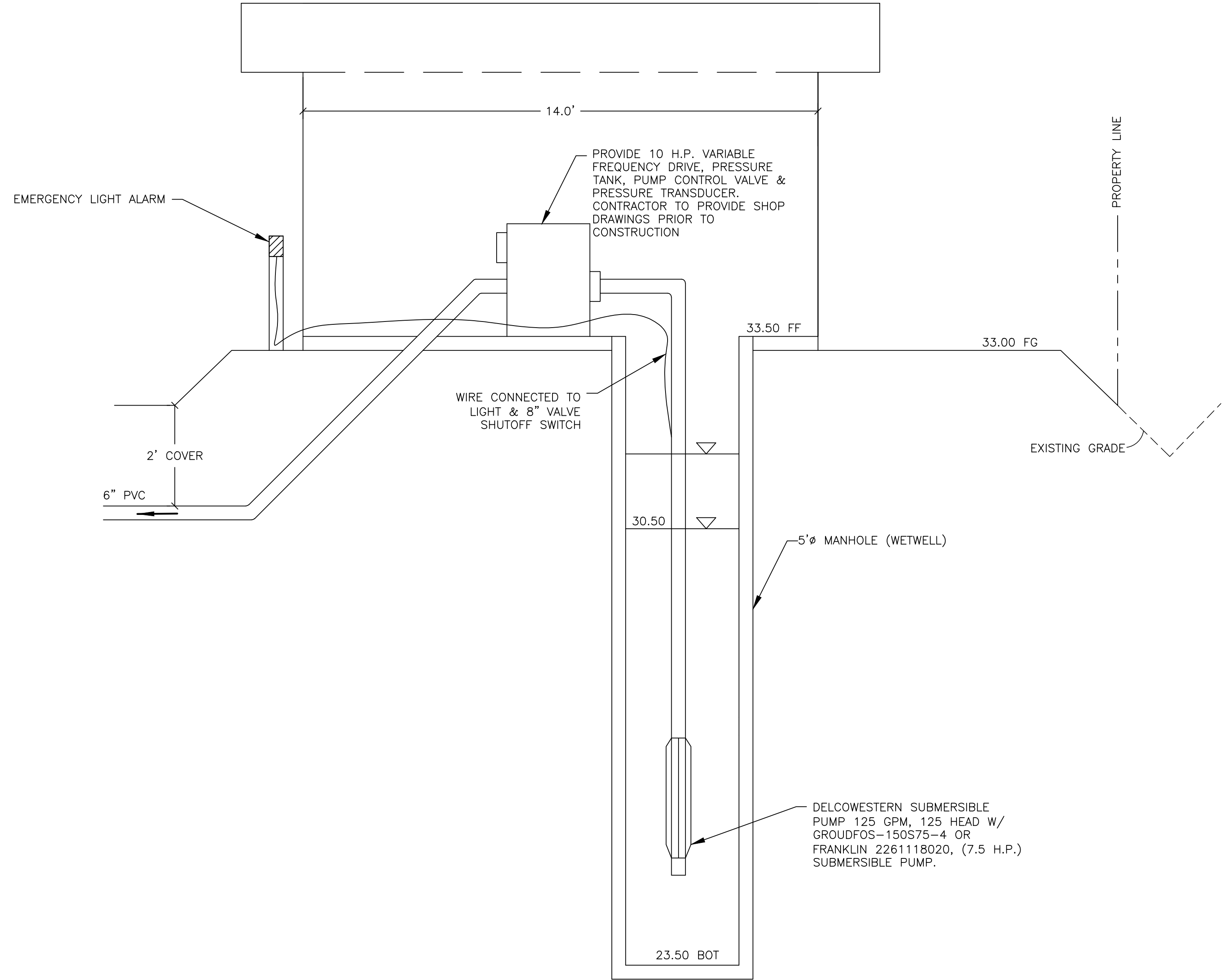
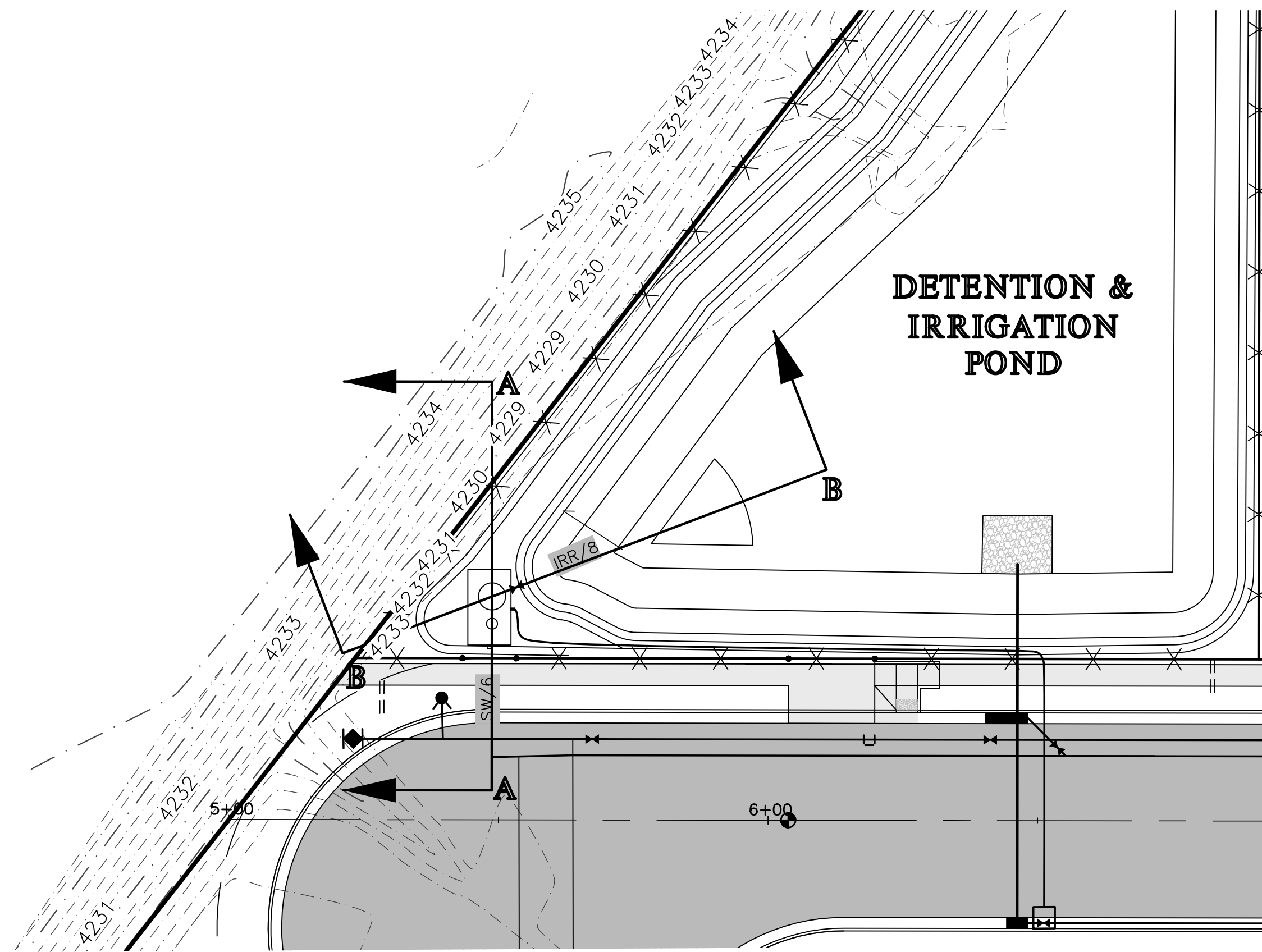

NOTE:
ELECTRICAL TO BE SECURED WITH STAINLESS STEEL FASTENERS AND SLEEVED IN CONDUIT AS REQUIRED BY BUILDING CODE

Reeve & Associates, Inc.
920 CHAMBERS STREET, SUITE 14, OGDEN, UTAH 84403
TEL: (801) 621-2100 FAX: (801) 621-2666 WWW.REEVE-ASSOC.COM
LAND PLANNERS • CIVIL ENGINEERS • LAND SURVEYORS
TRAFFIC ENGINEERS • STRUCTURAL ENGINEERS • LANDSCAPE ARCHITECTS

REVISIONS	DESCRIPTION
DATE	

Henry Flats Cluster Subdivision
WEST WEBER CITY, WEBER COUNTY, UTAH

Irrigation Pump House Details

Revised: 07-12-16

Project Info.

Engineer:	J. NATE REEVE
Drafter:	C. KINGSLEY
Begin Date:	NOVEMBER, 2015
Name:	HENRY FLATS CLUSTER SUBDIVISION
Number:	6272-01

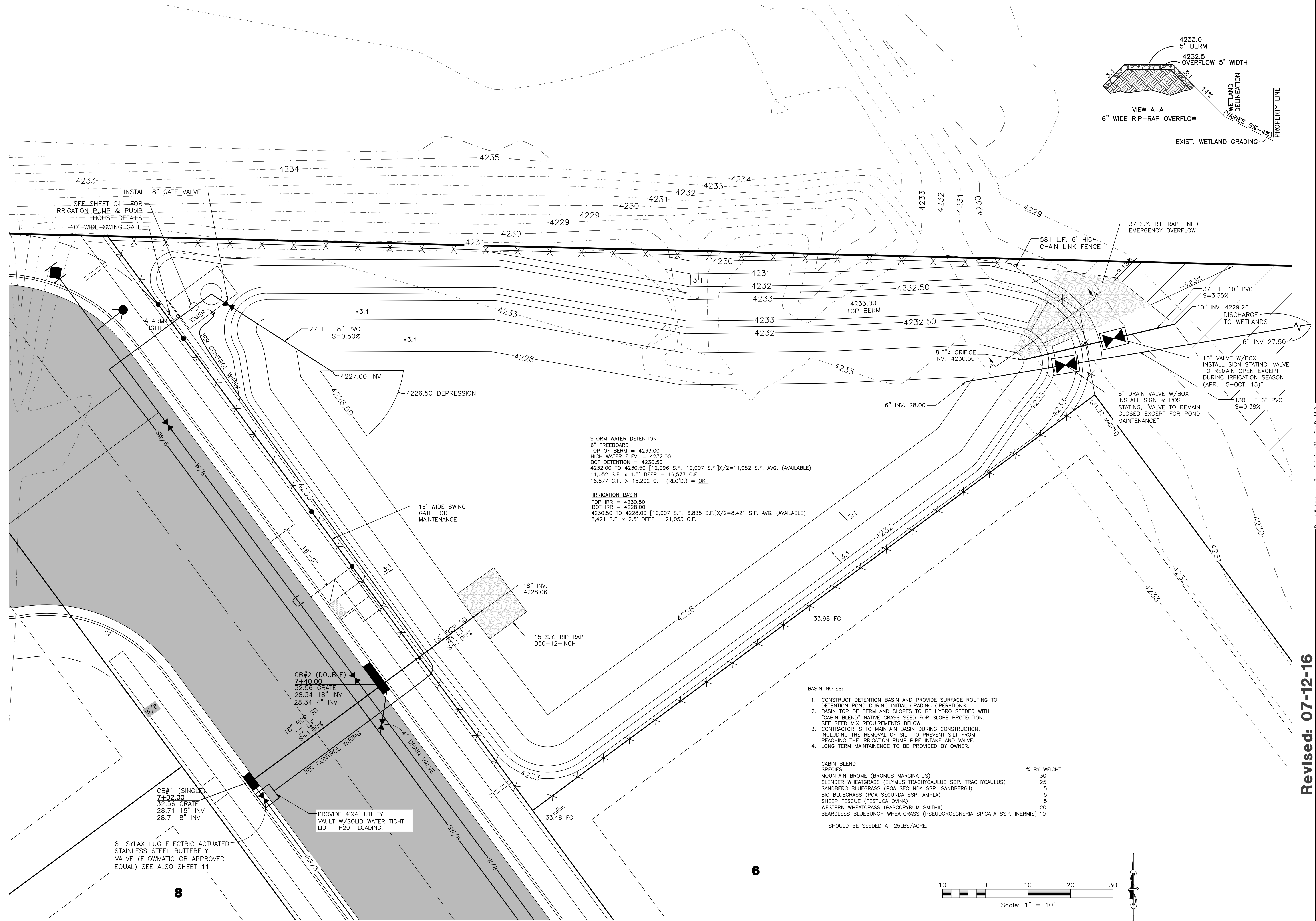

Reeve & Associates, Inc.
 920 CHAMBERS STREET SUITE 14, OGDEN, UTAH 84403
 TEL: (801) 621-2100 FAX: (801) 621-2666 WWW.REEVE-ASSOC.COM
 LAND PLANNERS • CIVIL ENGINEERS • LAND SURVEYORS
 TRAFFIC ENGINEERS • STRUCTURAL ENGINEERS • LANDSCAPE ARCHITECTS

IRA

REVISIONS	DESCRIPTION

Revised: 07-12-16

Henry Flats Cluster Subdivision
 WEST WEBER CITY, WEBER COUNTY, UTAH

Detention Basin Grading Plan

REGISTERED PROFESSIONAL ENGINEER
 375328
 J. NATE REEVE
 STATE OF UTAH

Project Info.
 Engineer: J. NATE REEVE
 Drafter: C. KINGSLEY
 Begin Date: NOVEMBER, 2015
 Name: HENRY FLATS CLUSTER SUBDIVISION
 Number: 6272-01

Sheet 12
 11 Sheets