



WESTERN WEBER TOWNSHIP PLANNING COMMISSION MEETING AGENDA

Tuesday, July 8, 2014
5:00 P.M.

- *Pledge of Allegiance*
- *Roll call*

1. Approval of the June 10, 2014 meeting minutes

2. Consent Agenda:

- 2.1. DR 2014-07 Consideration and action on an request for design review approval of a storage building that is more than twice the size of the home located at 1348 S 3500 W, Taylor within the Agricultural (A-1) Zone (Les Meyerhoffer, Applicant)

Petitions, Applications and Public Hearings

3. Administrative Items

3.1. New Business

- a. LVJ061314 Consideration and action on an administrative application for preliminary approval of the Jacquelyn Estates Cluster Subdivision Phase 1 and 2 (19 Lots) with a recommendation for the deferral of curb, gutter, and sidewalk improvements within the subdivision (private road) and on 2200 South within the Agricultural (A-1) Zone (CI Homes Inc., Applicant; Craig Standing, Agent)

4. Public Comment for Items not on the Agenda
5. Planning Commission Remarks
6. Planning Director Report
7. Legal Counsel Remarks

*The meeting will be held in the Weber County Commission Chambers, Weber Center, 2380 Washington Blvd., Ogden UT
A pre-meeting will be held at 4:30 P.M. in Room 108; No Decisions will be made in this meeting*



(In compliance with the American with Disabilities Act, persons needing auxiliary services for these meetings should call the Weber County Planning Commission 24 hours in advance of the meeting at 801-399-8791)

Minutes of the June 10, 2014 Western Weber County Township Planning Commission, held in the Weber County Commission Chambers, 2380 Washington Blvd., 1st Floor, Ogden, UT

Members Present: Jannette Borklund
Doug Hansen
Ryan Judkins
Wayne Andreotti
Andrew Favero
John Parke

Member Excused: Mark Whaley, Vice Chair

Staff: Sean Wilkinson, Planning Director; Scott Mendoza, Principal Planner; Ben Hatfield, Planner; Monette Hurtado, Legal Counsel; Sherri Sillitoe, Secretary

- Pledge
- Roll Call

Chair Borklund called the meeting to order; she led those in attendance with the pledge of allegiance and conducted the roll call as listed above.

1. Minutes
 - 1.1. Approval of the May 13, 2014 minutes

Jannette Borklund declared the May 13, 2014 meeting minutes approved as amended by Monette Hurtado.

Petitions, Applications and Public Hearings

2. Administrative Items

2.1. Old Business

- a. DR 2014-02 Consideration and action on an administrative application, design review approval of the M & M Storage Facility located at approximately 2803 North Highway 89; Paul Mackley, North View Holdings LLC Applicant

Ben Hatfield presented a report and indicated that the applicant is requesting approval of a site plan for the M & M Storage Facility located at approximately 2803 North Highway 89. The existing 5.23 acre site is in the Manufacturing (M-1) Zone and is surrounded by Pleasant View City. A portion of the property was divided off and then processed with the North View Holding LLC Subdivision. This remainder commercial piece at that time was not required to be included with the subdivision. Since the development of the adjacent lot required improvements and modifications to the existing access for this site, a new site plan approval is now required. Access to this site has been limited by UDOT as the parcel fronts on Highway 89. Cross access to the adjacent lot will be given to connect the two site's accesses.

The Western Weber Planning Commission on July 16, 2013 reviewed and approved a site plan for this site. The site was previously in Pleasant View City but had been de-annexed into the County some years ago. Due to the lack of records, when reviewed by the Planning Commission, it was assumed that all existing buildings were to be reviewed as if they were new. This worked for all of the buildings except for one, which did not meet the front setback requirement. This building was to be removed. The applicant has requested to keep the building and the existing use (night watchman's dwelling) on the site.

In 2002 Pleasant View City did approve the location and use of this building and all other improvements on this site. The city has provided a letter stating that; therefore, the Weber County will view that building and use as an existing non-conformity and allow it to continue as it historically has.

Staff recommends approval of the proposed site plan for the M & M Storage Facility subject to staff and other review agency requirements. This recommendation is based on the project being in compliance with applicable County Ordinances and subject to the conditions listed in the staff report.

Commissioner Hansen asked the reason for declaring the building as non-conforming. Ben Hatfield indicated that the rear setback was the reason. Commissioner Hansen indicated that is there any issues with keeping the building as a non-conformity because it doesn't quite meet the 50 ft. setback and Mr. Hatfield replied that he doesn't see any problems.

Chair Borklund asked if the 10 ft. trail will be installed. Mr. Hatfield indicated that Mr. Mackley has agreed to install the pathway on the west part of the property.

Commissioner Andreotti indicated that the trail is close to the railroad so will a fence be installed? Ben Hatfield indicated that there will be a 6 ft. chain-link fence installed on the property owner side. Commissioner Hansen indicated that he thought that the fence would be installed on the railroad side as well.

Commissioner Borklund asked if the trail easement will remain at 20 ft. and Mr. Hatfield indicated that the extra 10 ft. width was only to be temporary during construction of the trail. Is there concern that the easement would not be completed which is why it is being documented?

Discussion followed regarding fencing on the other side of the trail on the railroad side. Director Wilkinson indicated that typically escrows are tied to the occupancy of the building. He does not know what they would tie that escrow to due to no building being built as part of this approval. They can just make the escrow a requirement of approval and if the trail or other improvements are not built or installed, staff can hold up the issuance of a land use permit. Monette Hurtado agreed with Director Wilkinson.

Commissioner Judkins asked if they can hold a business license up if the improvements are not completed as intended. Chair Wilkinson replied yes.

Ben Hatfield indicated that in the staff report included a staff recommendation that any motion include construction that they follow the site plan exactly.

MOTION: Commissioner Favero moved to approve DR 2014-02 subject to staff and other agencies review. Commissioner Parke seconded the motion. A vote was taken and Chair Borklund indicated that the motion carried with a unanimous vote of those members present (Motion Carried 6-0).

3. Public Comment for Items not on the Agenda - None
4. Planning Commission Remarks - None
5. Planning Director Report – Chair Wilkinson indicated they will follow up on a field trip that Commissioner Andreotti requested. He recognized Charlie Ewert for passing the A.I.C.P. test; he is now certified as a professional planner.
6. Legal Counsel Remarks - None
7. Adjourn to a Work Session

The regular meeting was adjourned at to convene a work session.

WS1. Cluster Subdivision Discussion

Scott Mendoza reviewed the existing bonus density criteria of the Cluster Subdivision Ordinance. Note: The consensus decisions are bulleted and italicized.

(b) In the Agricultural Zones A-1, A-2 and A-3, up to a maximum bonus density of 50 percent may be approved and shall be based on an accumulation of the following:

(1) Developing a cluster subdivision that the planning commission determines meets the intent of this chapter: a 15 percent bonus may be granted.

Commissioner Borklund indicated that she wants to make it clear that someone can receive up to 50% bonus not that they will receive 50% guaranteed.

Commissioner Hansen indicated that he likes the smaller lot with smaller homes. He would like to see a variation rather than the standard.

Commissioner Andreotti indicated that that they need something that is pleasing to the eye. His vision of this is something with patio homes without the steps.

- *Do they want to lower the 50%? The members determined that for now, they will keep the 50%.*

Additional Summary

- *The wording "up to" will remain except on Item 1.*

(2) For each five percent of open space preserved in the subdivision in excess of the minimum required by this chapter: up to a five percent bonus density may be granted.

- *Delete the words "up to" and give 5%*

(3) Providing road stubs to adjacent property where the planning commission determines that streets are needed to provide for current or future traffic circulation: a five percent bonus density may be granted per stub up to a maximum of ten percent.

- *Delete this bonus.*

(4) Provides access to public lands: up to a ten percent bonus density may be granted.

- *Keep it as written*

(5) The common area is open to the public and provides amenities to the general public such as trail: up to a 15 percent bonus density may be granted.

- *Keep it as written*

(6) Ten percent of the lots and homes are permanently set aside for affordable housing (as outlined by the Affordable Housing Act of 1990): up to a 25 percent bonus density may be granted.

- *Keep it as written*

(7) Preservation of an agricultural parcel with an agricultural preservation plan approved by the planning commission and a agricultural preservation easement recorded on the parcel:

- a. Between ten and 20 acres: up to a 15 percent bonus density may be granted.
- b. 20 acres or larger: up to a 20 percent bonus density may be granted.

Under 7a) Commissioner Hansen indicated that they could consider a higher bonus than 15% to encourage people to cluster.

Chair Borklund asked what happens when there is nobody to take care of the parcel in the future.

Commissioner Parke indicated that this provision fits in with the general plan's intent more than any other. They could go where there is 10-20 acres they could allow a 20% bonus, between 20-30 acres allow a 30%, 30 to 40 is 40 and 40 to 50 is 50%.

- *Keep it as written*

(8) Preservation of historical sites and buildings (barns, homes, trails, or other structures): up to a five percent bonus density may be granted.

- *Keep it as is unless it will be permanent open space and then the bonus could be increased.*

(9) Development of excess sewage treatment capacity: up to a five percent bonus density may be granted.

- *Keep it as written*

(10) Preservation in open space of areas that are identified by the state division of wildlife resources as providing valuable wildlife habit: up to a ten percent bonus density may be granted.

- *Keep it as written*

(11) Preservation in open space of areas that are identified by the state division of wildlife resources as critical wildlife habit: up to a 15 percent bonus density may be granted.

Chair Wilkinson indicated that the State defines the terms and they would have a list.

Commissioner Favero's asked questions regarding not mitigating wetlands. Scott Mendoza indicated that he could develop language for wetlands and accompanying bonus.

Commissioner Borklund indicated that the State Division of Wildlife Resources would be the reviewing authority.

- *Keep it as written*

(12) Open space is contiguous to permanently preserved open space on an adjoining property: up to a 20 percent bonus density may be granted.

- *The consensus was that the 20% bonus offered should be higher. It could be based on a scale starting with 5 acres. It was determined that they will offer a 30% bonus density for this issue.*

Commissioner Andreotti stated that he would like to see something in the ordinance regarding design or something that is pleasing to people.

Scott Mendoza indicated that the ordinance amendment will include a section titled "General Cluster Subdivision and Design Layout Standards.

Scott Mendoza asked if there are any other bonuses they would like to provide

Commissioner Hansen replied: Water Conservation, although that would be harder to regulate.

The meeting was adjourned at 7:00 p.m.

Respectfully Submitted,

Sherrill Sillitoe, Secretary
Weber County Planning Commission

DRAFT



Staff Report to the Western Weber Planning Commission

Weber County Planning Division

Synopsis

Application Information

Application Request: Consideration and action on a request for design review approval of a storage building that is more than twice the size of the home.

Agenda Date: Tuesday, July 08, 2014

Applicant: Les Meyerhoffer

File Number: DR 2014-07

Property Information

Approximate Address: 1348 South 3500 West, Taylor

Project Area: 0.78 acres

Zoning: Agricultural A-1

Existing Land Use: Residential

Proposed Land Use: Residential

Parcel ID: 15-060-0077

Township, Range, Section: T6N, R2W, Sec 22

Staff Information

Report Presenter: Ben Hatfield
bhatfield@co.weber.ut.us
801-399-8766

Report Reviewer: JG

Applicable Ordinances

- Weber County Land Use Code Title 104 (Zones) Chapter 5 Agricultural (A-1)
- Weber County Land Use Code Title 108 (Standards) Chapter 7 Supplementary and Qualifying Regulations

Type of Decision

Administrative Decisions: When the Planning Commission is acting as a land use authority, it is acting in an administrative capacity and has much less discretion. Examples of administrative applications are design reviews, flag lots, and subdivisions. Administrative applications must be approved by the Planning Commission if the application demonstrates compliance with the approval criteria.

Background

The applicant is requesting approval of a storage building that is approximately 2400 square feet at 1348 South 3500 West in Taylor. The property is zoned Agricultural A-1 and the lot is 0.78 acres (BOA 11-75).

“The purpose and intent of design review by the planning commission is to secure the general purposes of this chapter and the master plan and to ensure that the general design, layout and appearance of buildings and structures and the development of property shall in no case be such as would impair the orderly and harmonious development of the neighborhood or impair investment in and occupation of the neighborhood”.

There is a 950 square foot single family dwelling on the property as well as some small sheds. The proposed garage is a 2,400 square foot (40 foot by 60 foot) metal from Roper Buildings. The building will be used for the storage of agricultural vehicles and equipment, as well as for personal storage. The rectangular building will be five feet from both the rear and side lot lines, 180 feet from the front lot line, and 120 feet behind the home.

Section 108-7-16, Large accessory buildings (1,000 square feet or larger), number (c) states “ Accessory buildings that exceed the dwelling in area by more than double as measured by the footprint of the dwelling shall require approval by the planning commission as a design review”. The tax records indicate (exhibit D) that the dwelling is 950 square feet in area; therefore Planning Commission approval is required.

In Section 108-7-4, Area of accessory buildings it states “No accessory building or group of accessory buildings in any residential estates zone, cluster subdivision, or PRUD shall cover more than 25 percent of the rear yard”. Since this property is zoned Agricultural (A-1), there are no lot coverage standards.

Section 108-7-16, list the setbacks for large accessory buildings (1,000 square feet or larger) as follow:

(a) Accessory buildings 1,000 square feet or larger in area that accommodates uses meeting zoning requirements shall:

- (1) Be located at least six feet from the rear of a dwelling in the residential estates zones and at least ten feet from the rear of a dwelling in the agricultural and forest zones.
- (2) Have a side yard setback of at least ten feet on an interior lot and 40 feet on a corner lot where the side property line is adjacent to a street.
- (3) Have a maximum height of 25 feet.

Exceptions: The side yard may be reduced to three feet (except in a forest zone) and the height increased to 35 feet if the accessory building is located at least 100 feet from a property line adjacent to a street and at least 40 feet from a dwelling on an adjacent lot.

Summary of Planning Commission Considerations

- Are the project layout and setbacks consistent with applicable requirements of the Weber County Land Use Code?
- Would this project impair the orderly and harmonious development of the neighborhood or impair investment in and occupation of the neighborhood?

Conformance to the General Plan

This site plan conforms to the General Plan by meeting the outlined permitted land uses of the zone in which it is located, and all of the applicable requirements of the Weber County Land Use Code.

Conditions of Approval

- Requirements of the Weber County Engineering Division
- Requirements of the Weber Fire District
- Requirements of the Weber County Building Inspection Division

Staff Recommendation

Staff recommends approval of the site plan for a large accessory building at 1348 South 3500 West subject to staff and other review agency requirements. This recommendation is based on the project complying with applicable County Ordinances. The Planning Commission may base the approval on the following findings:

- The proposed use is allowed in the A-1 Zone
- All development standards have been met

Exhibits

- A. Design Review Application with narrative
- B. Site Plans
- C. Building Plans
- D. Assessor's footprint of the home

Map 1

Adjacent Land Use

North:	Residential	South:	Residential
East:	Residential	West:	Residential

Map 1

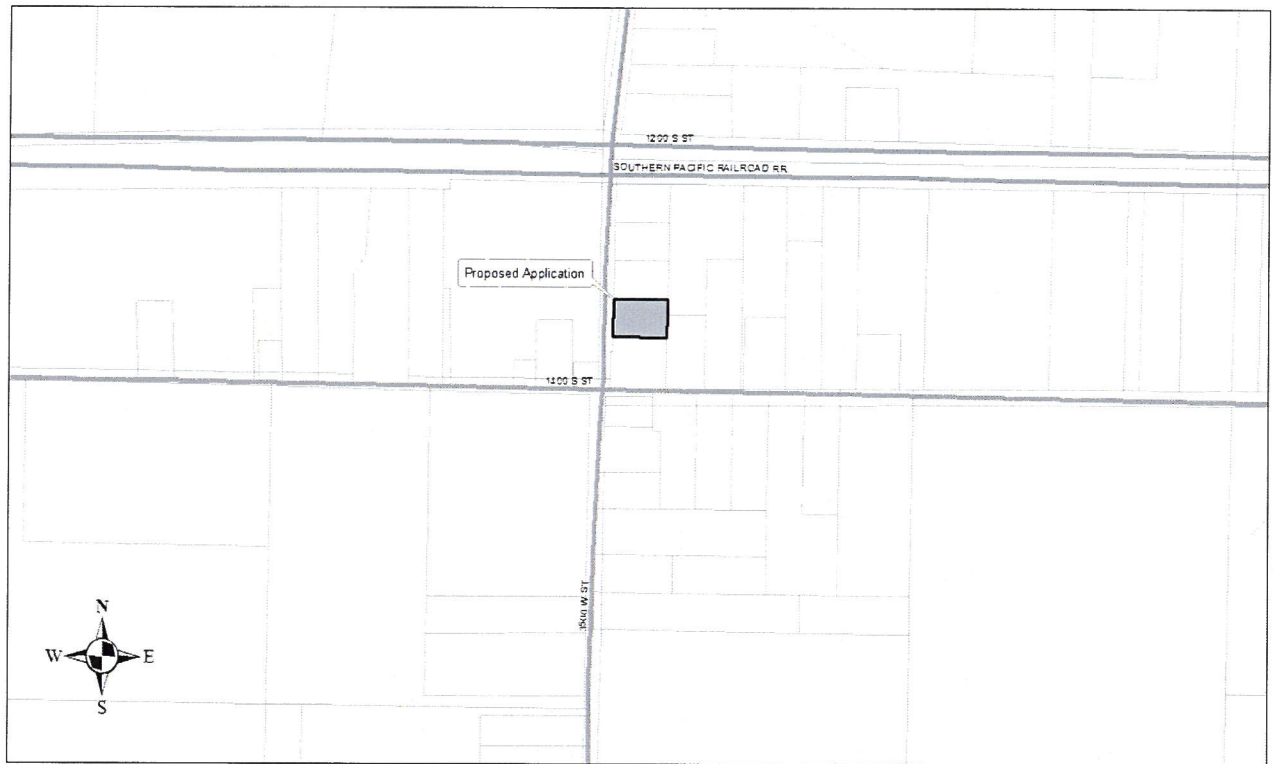

Weber County Design Review Application

Application submittals will be accepted by appointment only. (801) 399-8791. 2380 Washington Blvd. Suite 240, Ogden, UT 84401

Date Submitted / Completed 6/26/14	Fees (Office Use) 100.00	Receipt Number (Office Use) 3137	File Number (Office Use) DR2014-07
---------------------------------------	-----------------------------	-------------------------------------	---------------------------------------

Property Owner Contact Information

Name of Property Owner(s) Leslie K Meyerbeffer	Mailing Address of Property Owner(s) 1348 S 3500W Ogden UT 84401
Phone 801 7267205	Fax

Email Address lesmgunnut@live.com	Preferred Method of Written Correspondence <input checked="" type="checkbox"/> Email <input type="checkbox"/> Fax <input type="checkbox"/> Mail
--------------------------------------	--

Authorized Representative Contact Information

Name of Person Authorized to Represent the Property Owner(s) Les Meyerbeffer	Mailing Address of Authorized Person
Phone Same as Above	Fax

Email Address	Preferred Method of Written Correspondence <input type="checkbox"/> Email <input type="checkbox"/> Fax <input type="checkbox"/> Mail
---------------	---

Property Information

Project Name Meyerbeffer Garage	Current Zoning
Approximate Address 1348 S 3500W Ogden Utah 84401	Land Serial Number(s)

Proposed Use
Storage

Project Narrative
The Barn we are putting up is 2400 square feet. My home is only 1000 square feet. The barn is going to be used for storing my farm equipment + toys. It is more than double the size of my home by 400 feet.

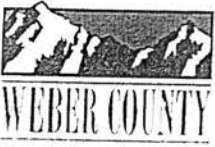

WEBER COUNTY CMS RECEIPTING SYSTEM
OFFICIAL RECEIPT

cms314a
 Page 1 of 1

*** REPRINT ***

Date: 26-JUN-2014

Receipt Nbr: 3137

ID# 21552

Employee / Department: ANGELA - 4181 - PLANNING

Monies Received From: LESLIE MEYERHOFFER

Template: PUBLIC WORKS

Description: DESIGN REVIEW

The following amount of money has been received and allocated to the various accounts listed below:

Total Currency	\$	_____	.00
Total Coin	\$	_____	.00
Total Debit/Credit Card	\$	_____	100.00
Pre-deposit	\$	_____	.00
Total Checks	\$	_____	.00
Grand Total	\$	=====	100.00

Account Number	Account Name	Comments	Total
2014-08-4181-3419-0550-000	ZONING FEES		100.00
TOTAL \$			100.00

Check Amounts

Total Checks:

Total Check Amounts: \$.00

*** SAVE THIS RECEIPT FOR YOUR RECORDS ***



I WILL RUN A SUCCESSFUL PROJECT



Les Meyerheller

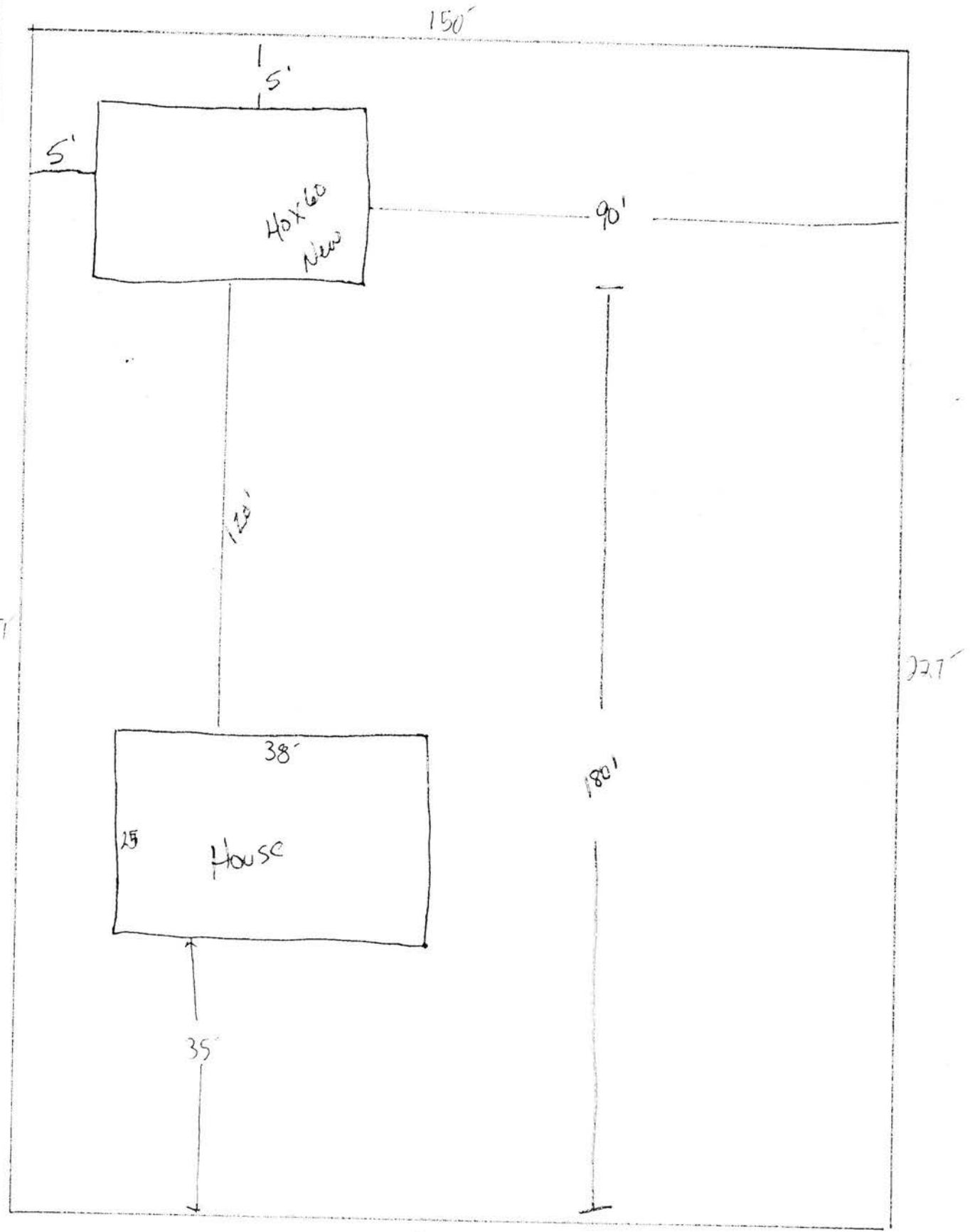

ROPER BUILDINGS

MEYERHOFFER BUILDING

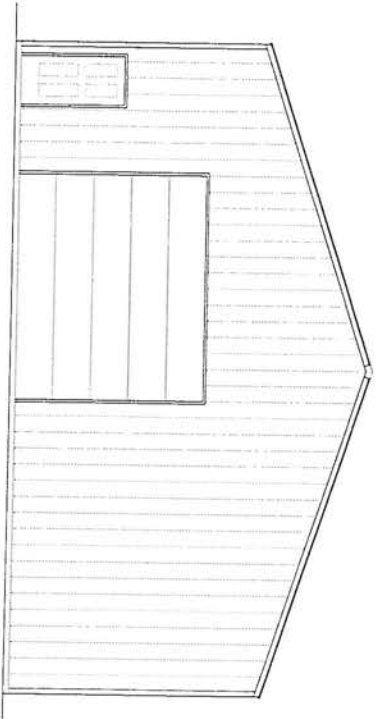

06/18/14

PROJECT INFORMATION:
 MEYERHOFFER BUILDING
 1348 SOUTH 3500 WEST
 OGDEN, UTAH

BUILDING INFORMATION:
 SQUARE FOOTAGE 2400
 DIMENSIONS: 40'x60'

DRAWING INDEX:

- 00 COVER SHEET
- 01 FOUNDATION PLAN
- 02 FLOOR PLAN
- 03 GIRT PLAN
- 01B ELEVATIONS
- 04 ROOF PLAN
- 05 PANEL LAYOUT
- 06 DETAILS
- 07

GENERAL CONTRACTOR:
 ROPER BUILDINGS
 CONTACT: DAN SCARBROUGH
 PHONE: 801-540-5586

CONSULTING STRUCTURAL ENGINEER:
 PRICE ENGINEERING
 990 WEST 7900 SOUTH
 WILLARD, UTAH
 (801) 771-0542
 CONTACT: KYLE PRICE

DRAFTER:
 LAKMAN DESIGNS
 SOUTH WEBER, UTAH
 (801) 205-0382
 (801) 479-1661 FAX
 CONTACT: TIM LAKMAN

THESE PLANS ARE ISSUED TO:
 ROPER BUILDINGS
 FOR THE CONSTRUCTION OF ONE
 BUILDING LISTED IN THE PROJECT
 INFORMATION AREA OF THIS PAGE

DRAWING/REVISION DATE:
 06/03/14

FOUNDATION PLAN

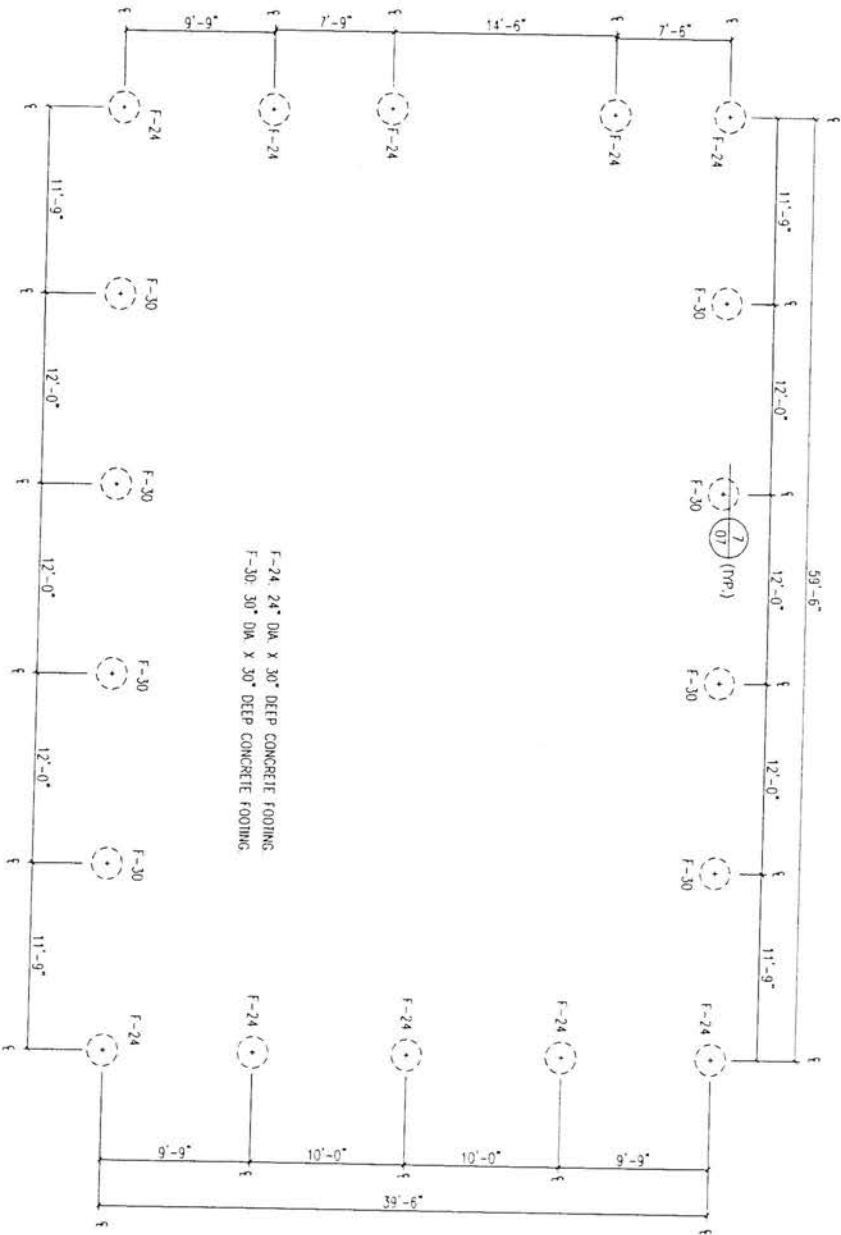

08/18/14

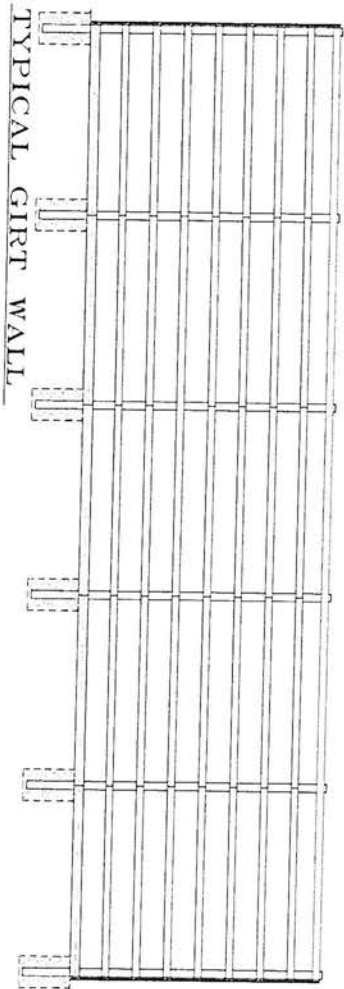
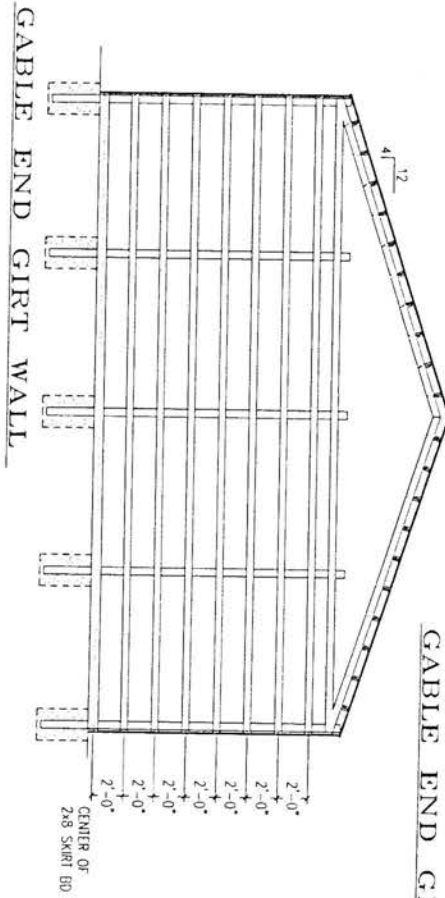
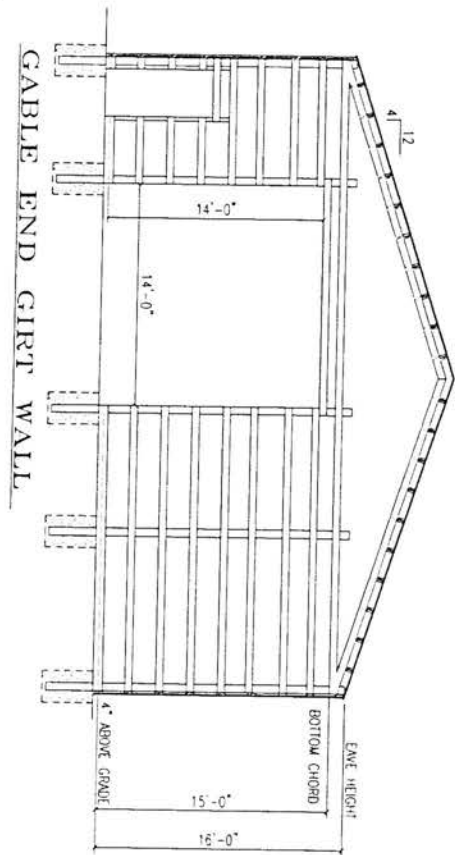

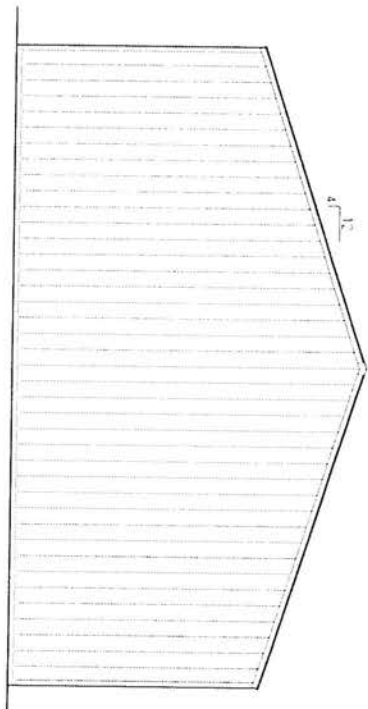

CABLE END ELEVATION

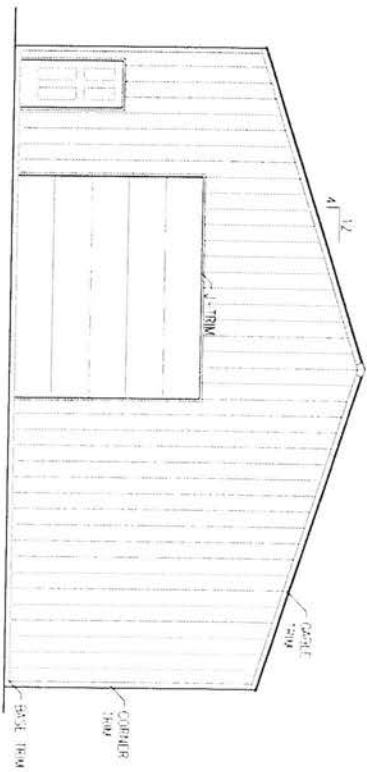

CABLE END ELEVATION

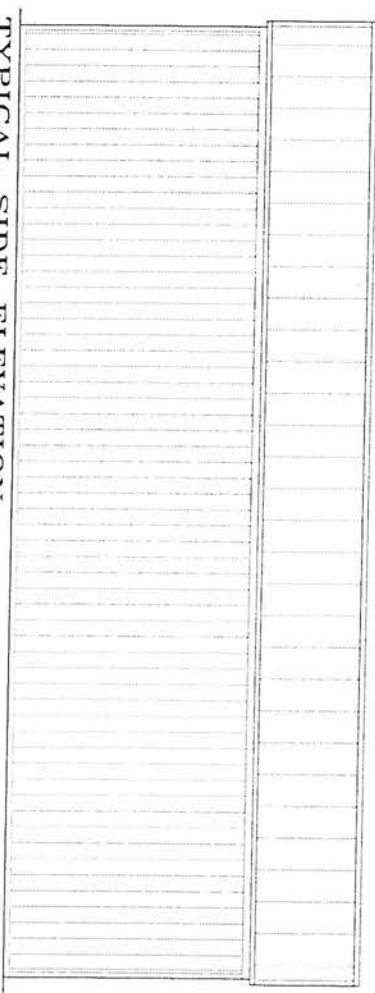

TYPICAL SIDE ELEVATION

ROOF PLAN

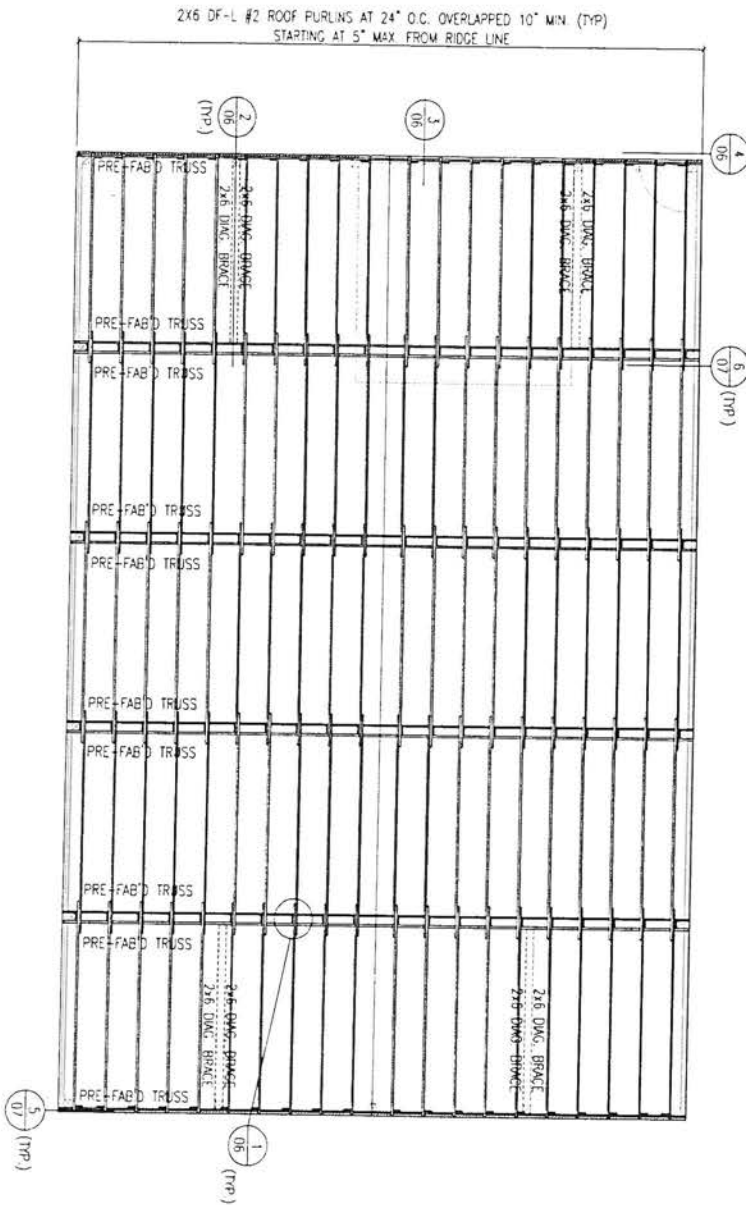

08/18/14

MEYERHOFFER BUILDING

1348 SOUTH 3500 WEST
OGDEN, UTAH

ROPER BUILDINGS

DAN SCARBROUGH
(801) 540-5586

DATE: 08-03-14
SCALE: 1/8" = 1'-0"
JOB: MEYERHOFFER
SHEET: 04

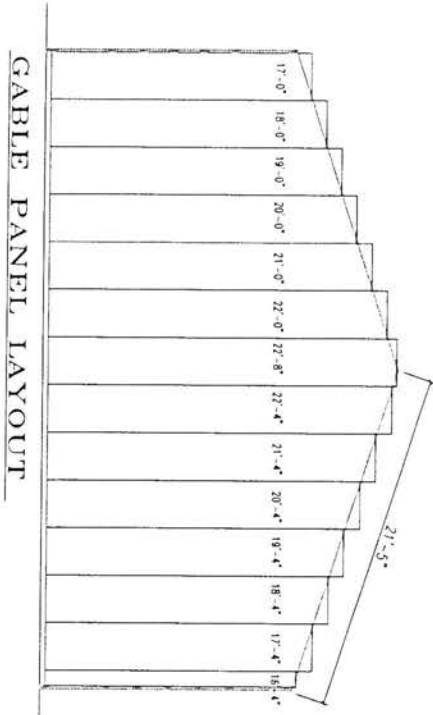

GABLE PANEL LAYOUT

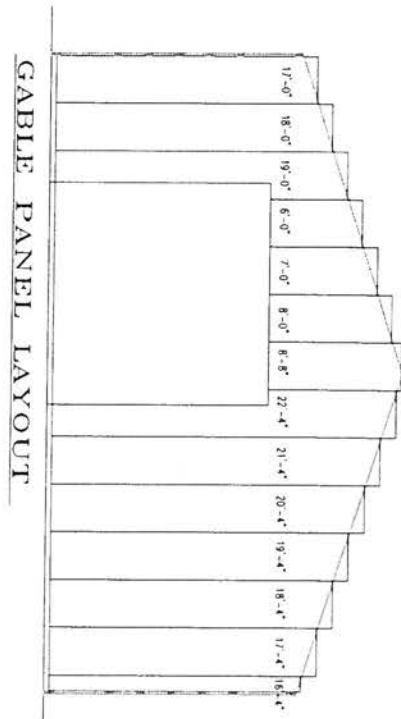

GABLE PANEL LAYOUT

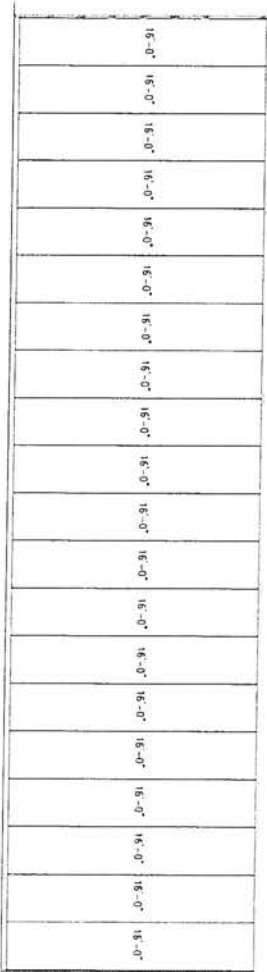

TYPICAL PANEL LAYOUT

ENGINEERING NOTES:

DESIGN CRITERIA

GENERAL:	1. PLEASE REFER TO THE STRUCTURAL CALCULATIONS FOR ALL SPECIFICATIONS AND DESIGN CRITERIA NOT LISTED HERE. WHERE DETAILS ARE NOT SPECIFIED, TYPICAL DETAILS AS SPECIFIED ON PLANS AND ON THE STRUCTURAL DETAILS PLAN SHEET SHALL APPLY.
DESIGN CRITERIA:	2. DESIGN ACCORDING TO THE 2012 IBC, RISK CATEGORY 1 FOR SPECIFICATIONS NOT SHOWN REFER TO THE 2012 IBC. DESIGN SPECTRAL RESPONSE SDS: 922. SOIL SITE CLASS=D (ASSUMED). WIND LOAD: DESIGN SPEED: 120 MPH 3 SEC Gust EXPOSURE C: I=0.87 SDC=D ws=0 PSF SDC=D ws=0 PSF SNOW LOAD: DESIGN SPEED: 120 MPH 3 SEC Gust EXPOSURE C: I=0.87 SDC=D ws=0 PSF DEAD LOADS: ROOF 3 PSF WALLS 3 PSF

CONC. FOUNDATION PIERS	SIZE (MINIMUM): 24"-30" DIAMETER x 2'-6" TO 4'-2" DEEP SEE FOOTING PLAN. REINFORCEMENT: NO PIER REINFORCEMENT.
------------------------	--

SOILS AND EXCAVATION NOTES	UNIFIED SOIL CLASSIFICATION: NO SOILS REPORT PROVIDED. STABLE SOIL CHARACTERISTICS ASSUMED. ALLOWABLE BEARING PRESSURE: 1500 PSF END BEARING (ASSUMED). GEOTECHNICAL HAZARDS FOUND ON OR AROUND THE SITE, INCLUDING EXPANSIVE CLAYS, OR SOILS FOUND AT THE SITE WHILE EXCAVATION OCCURS WHICH DIFFERS FROM THOSE ASSUMED SHOULD BE BROUGHT TO THE ATTENTION OF THE BUILDING OFFICIAL AND ENGINEER. THE STRUCTURAL ENGINEER OF RECORD IS NOT RESPONSIBLE FOR DIFFERENTIAL FOOTING SETTLEMENT DUE TO INCONSISTANT OR UNSTABLE SOIL QUALITY.
----------------------------	---

CONCRETE AND REINFORCEMENT NOTES	CONCRETE MIN. 28 DAY STRENGTH (F'c) W/ NORMAL 145 PCF DENSITY: 1. FOOTINGS: 3000 PSI. 2. SLABS ON GRADE: 3500 PSI REQUIRED (4000 PSI RECOMMENDED). ALL SLABS PROVIDE A MIN. THICKNESS OF 4" W/ 4" DEEP MIN. CRUSHED GRAVEL BASE. PROVIDE 1" DEEP CONTRACTION / CONSTRUCTION JOINTS NO FURTHER THAN 10' APART IN ANY DIRECTION.
----------------------------------	--

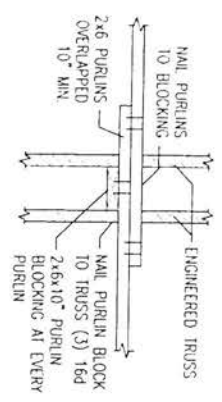

1 TYPICAL PURLIN CONNECTION
06 N.T.S.

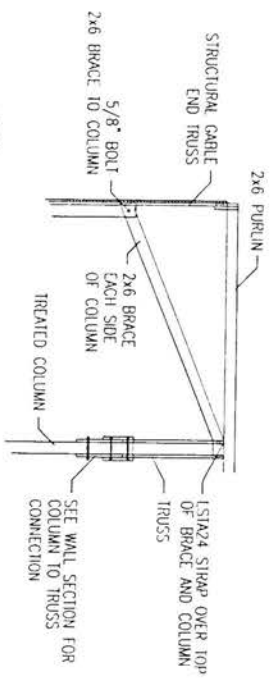

2 COLUMN TO TRUSS BRACE
06 N.T.S.

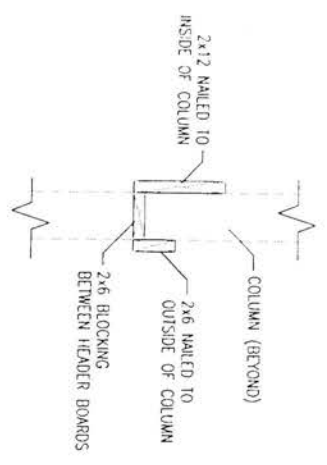

3 O.H. DOOR HEADER
06 N.T.S.

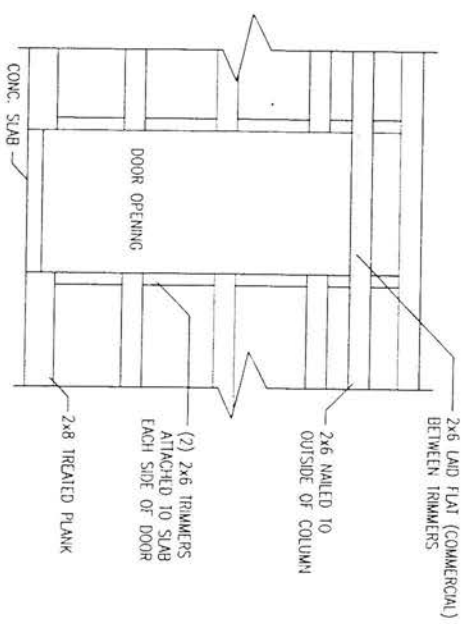

4 MAN DOOR OPENING
06 N.T.S.



08/18/14

5 CORNER BLOCKING DETAIL
N.T.S.

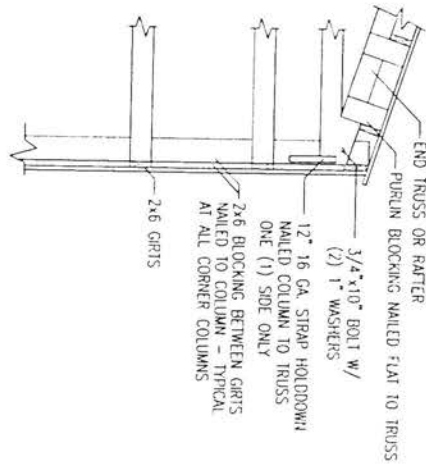

6 TYPICAL WALL SECTION
N.T.S.

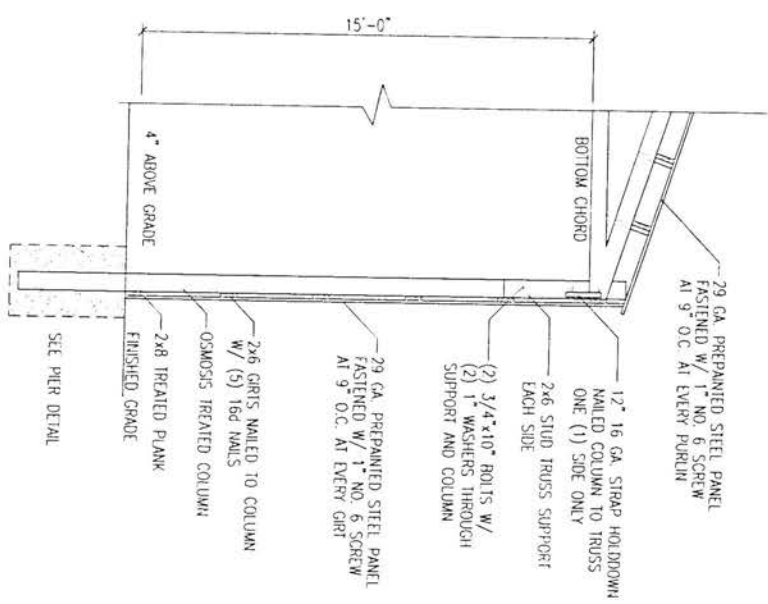

7 PIER DETAIL (TYPICAL)
N.T.S.

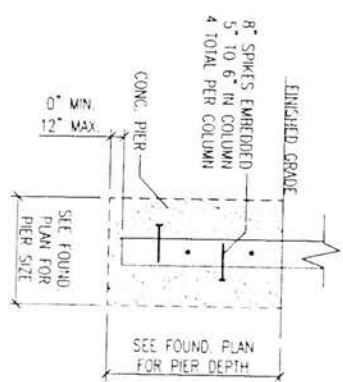

08/18/14

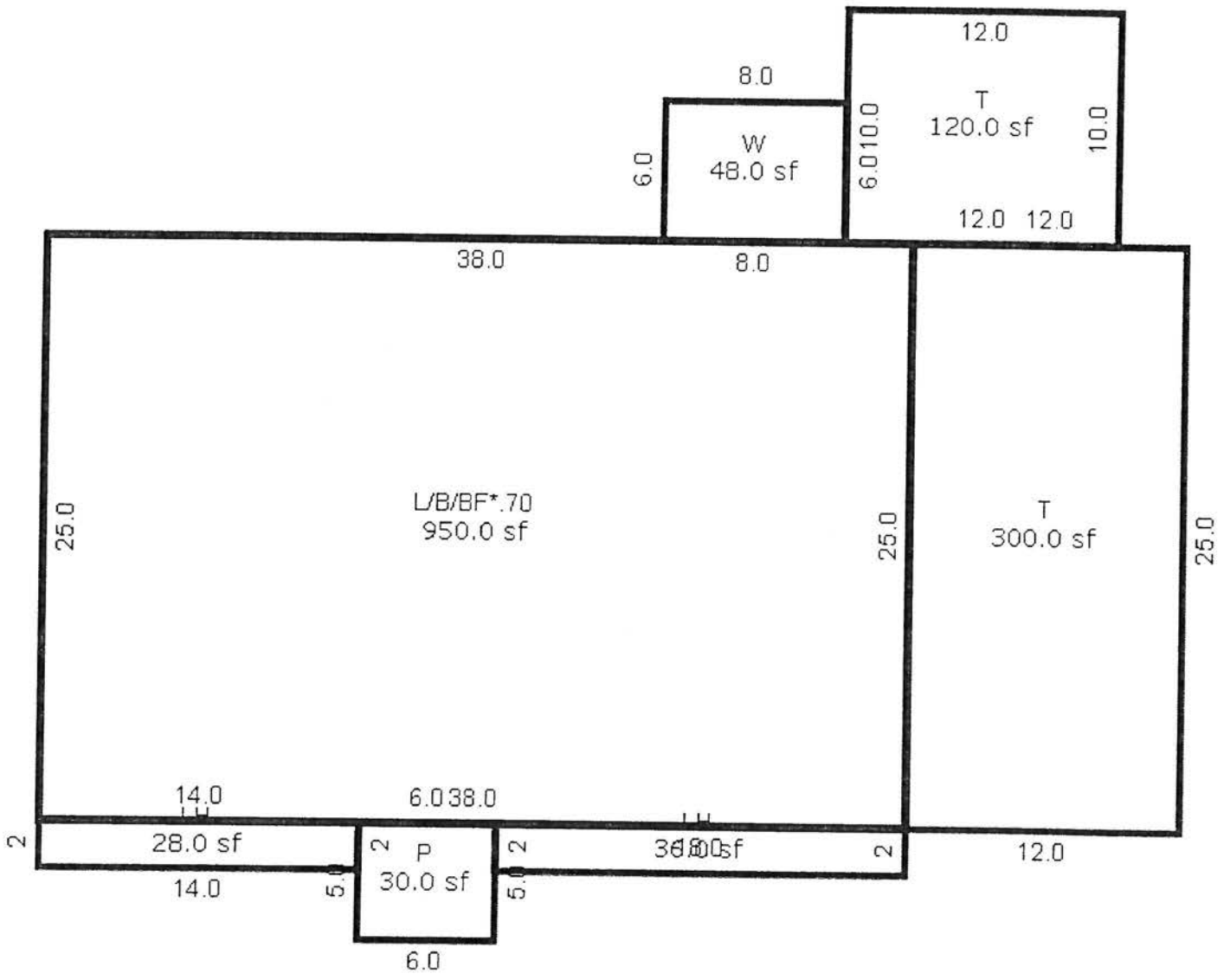



Staff Report to the Western Weber Planning Commission

Weber County Planning Division

Synopsis

Application Information

Application Request: Consideration and action on preliminary approval of Jacquelyn Estates Cluster Subdivision Phase 1 and 2 (19 lots) with a recommendation for the deferral of curb, gutter, and sidewalk improvements within the subdivision (private road) and on 2200 South.

Agenda Date: Tuesday, July 08, 2014

Applicant: Craig Standing, agent CJ Homes Inc.

File Number: LVJ061314

Property Information

Approximate Address: 4900 West 2200 South

Project Area: 6.794 acres

Zoning: A-1

Existing Land Use: Agricultural

Proposed Land Use: Residential

Parcel ID: 15-079-0108

Township, Range, Section: 6N 2W Sec 29

Staff Information

Report Presenter: Ben Hatfield
bhatfield@co.weber.ut.us
801-399-8766

Report Reviewer: JG

Applicable Codes

- Weber County Land Use Code Title 106 (Subdivisions)
- Weber County Land Use Code Title 104 (Zones) Chapter 5 (A-1 Zone)
- Weber County Land Use Code Title 108 (Standards) Chapter 3 (Cluster Subdivisions)

Type of Decision

Administrative Decisions: When the Planning Commission is acting as a land use authority, it is acting in an administrative capacity and has much less discretion. Examples of administrative applications are design reviews, flag lots, and subdivisions. Administrative applications must be approved by the Planning Commission if the application demonstrates compliance with the approval criteria.

Background

The applicant is requesting preliminary approval of Jacquelyn Estates Cluster Subdivision Phase 1 and 2 (19 lots) with a recommendation for the deferral of curb, gutter, and sidewalk improvements within the subdivision (private road) and on 2200 South. This proposed 14.517 acre subdivision on the corner of 4900 West and 2200 South is located in the A-1 Zone. The request is for a 19 lot cluster subdivision consisting of two phases (6 lots and 13 lots); with a private road (50 foot) that connects through the subdivision to both 4900 West and 2200 South.

4900 West was built as part of the Holgate Subdivision in 1998, with the entire width being dedicated for public use. 2200 South is a long time County road with some portions that have not been developed and dedicated to the public. With these two phases, half of the width for that road for a length of 1,328 feet will be dedicated to the public. That additional one acre of road dedication is significant in the design of the proposed cluster subdivision regarding the number of lots and amount of open space.

Summary of Planning Commission Considerations

- Does the subdivision meet the requirements of applicable Weber County codes? Because cluster subdivisions are not frequently reviewed by the Planning Commission a copy of the cluster standards has been provided as exhibit B.

Lot Compliance with Applicable Ordinances: Jacquelyn Estates is designed as a cluster subdivision so lot sizes and frontage requirements will differ from the normal requirements of the A-1 Zone. The lots in Phase 1 range from 14,000 square feet to 14,300 square feet in size. Lots in cluster subdivisions if connected to sewer may be reduced to 10,000 square feet and 100 feet in width. It appears that Lots 3, 4 and 19 may not meet the minimum lot width requirement of 100 feet. All of the lots will need to meet these area and frontage requirements before a recommendation for final approval is given.

Open Space and Bonus Density Requirements: Collectively with phases 1 and 2, the proposed cluster subdivision is 14.517 acres, but 2.348 acres will be used as roadway leaving 12.169 acres of developable area. A cluster subdivision in the A-1 Zone requires a minimum of 30% (3.65 acres) of the subdivision to be preserved as permanent open space.

The total open space to be provided is 5.916 acres (49%). This is 19% more open space than is required to be set aside. Bonus density can be granted for this additional area as 5% bonus for each 5% of excess area. Since there is 19 % in excess the request is for 19 % bonus density.

As the proposed cluster subdivision has been designed in a way that fronts all lots on to the private street, open space is left along 4900 West and much of 2200 South. The applicant is requesting a 15 % bonus for meeting the standards of a cluster subdivision.

Two of the 19 lots will be permanently set aside for affordable housing, accounting for 10 % of the project. For meeting this standard the bonus density request is for 25%. Lot 1 in Phase 1 will be designated with this restriction. It has not yet been shown which lot in Phase 2 will be identified.

As the total potential bonus density is 59%, only the maximum bonus density of 50% can be requested for this subdivision based on the following:

- 15% for developing a cluster subdivision that meets the intent of the standards
- 19% for additional open space in excess of the minimum 30 % open space
- 25% for providing two lots permanently set aside for affordable housing

The number of lots allowed by right is 13 (40,000 square feet) and the 50% bonus raises the total to the 19 requested.

Open Space Amenities/Pathways: Most of the amenities are to be in phase 1 of Jacquelyn Estates. The open space in this phase will contain a 3.819 acre area to be landscaped as horse pasture with native grasses. Eleven trees are to be spaced along the public roads with other fruit trees along the rear of Lots 1-4. An interior trail system connected to the private road will be made up of a 5 foot wide gravel path around the open area and Lots 1-4. A park area has been proposed containing a 30 foot by 20 foot pavilion for picnic tables, sand pit, grass area, and playground. One unique feature of this plan is an 80 foot by 105 foot community garden area for the lot owners to share. The garden may contain rented grow boxes available for residents. Details of how this will look and function are needed for this area and will need to be shown with the Planning Commission's final review.

Roads/Fencing: A six foot tall fence has been proposed to surround the subdivision. Again, better details of the fence will need to be submitted prior to a final review. On the entrance from 4900 West will be a subdivision monument sign with shrubs and an entrance gate, the details of which are missing at this time. A 50 foot wide private right of way has been proposed, with asphalt being 24 feet wide. Curb, gutter, and sidewalk have not been proposed for this private road will need to receive a recommendation for deferral. Drainage swells are to be on both sides of the road to collect runoff and convey it to a retention area in the open space.

Water and Wastewater: Culinary water will be provided by Taylor West Weber Water and secondary water will be provided by Hooper Irrigation. Wastewater treatment will be provided by Central Weber Sewer Improvement District.

Conformance to the General Plan

The proposed subdivision meets the requirements of applicable Weber County Land Use Code and conforms to the General Plan.

Conditions of Approval

- Requirements of the Weber County Engineering Division
- Requirements of the Weber Fire District
- Requirements of the Weber County Surveyors Department

Staff Recommendation

Staff recommends preliminary approval for the Jacquelyn Estates Cluster Subdivision Phase 1 and 2 with a recommendation for the deferral of curb, gutter, and sidewalk improvements for the private roads within the subdivision and on 2200 South.

Exhibits

- Proposed Plat and Improvement Plans
- Cluster Subdivision Standards

Maps

Adjacent Land Use

North: Residential
West: Residential

South: Residential
East: Agricultural

Map 1

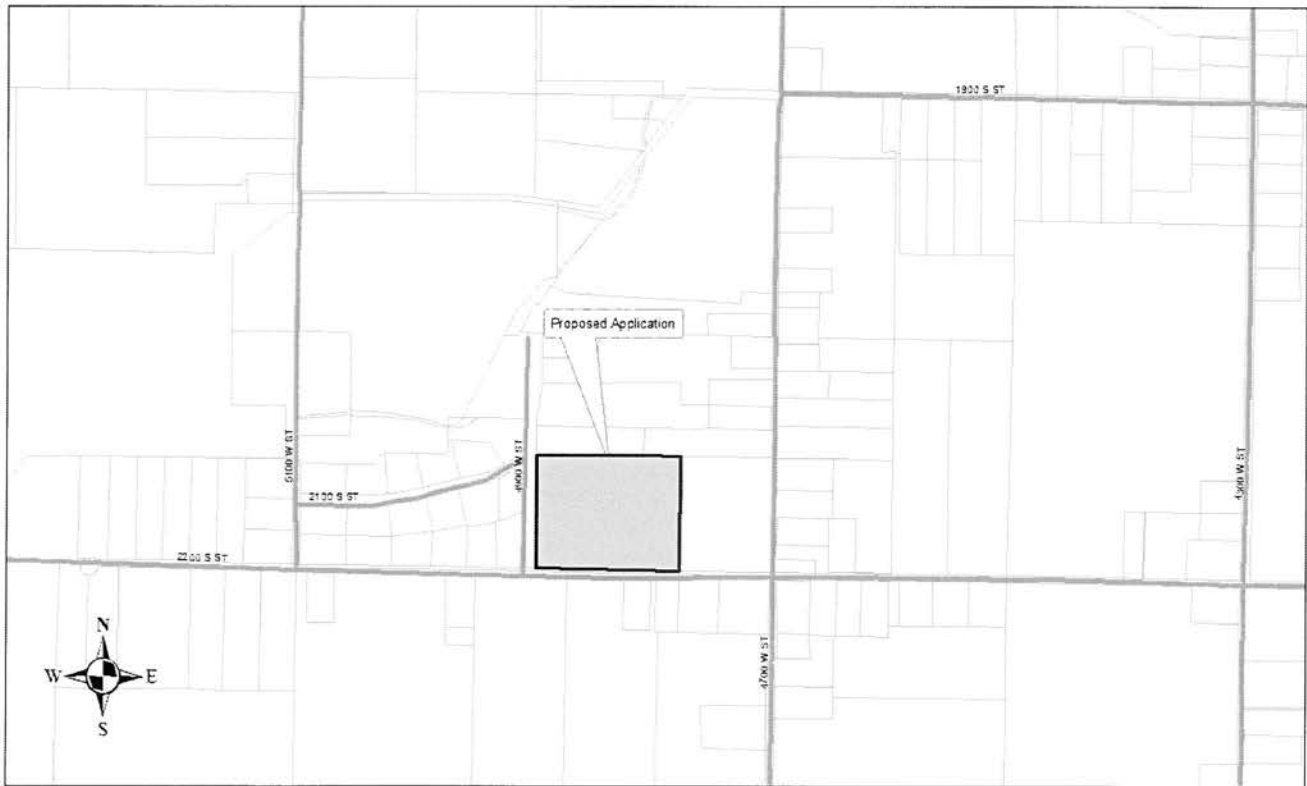

Map 2

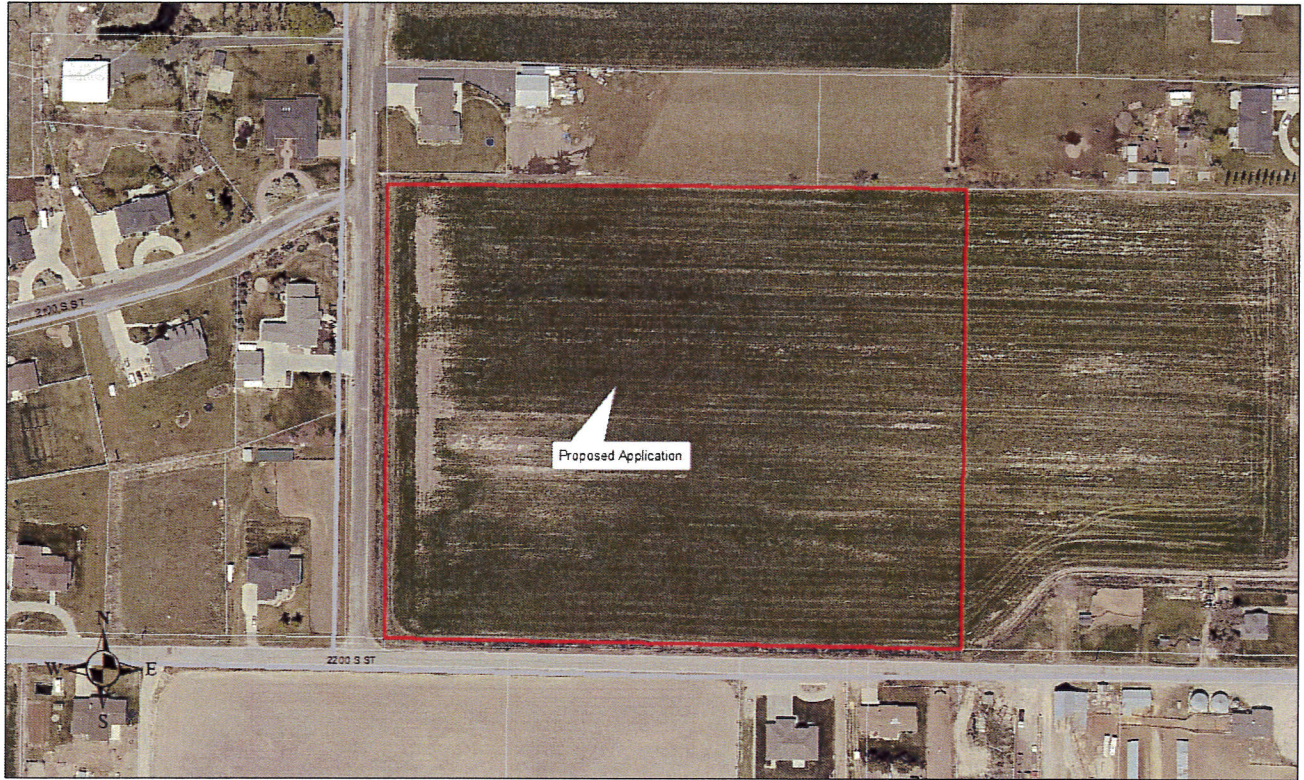

Landmark Surveying, Inc.
4646 S. 3500 W. suite 3
West Haven, Ut. 84401
801-731-4075
info@landmarksurveyutah.com

June 04, 2014

Weber County Planning

RE: JACQUELYN ESTATES SUBDIVISION PH 1

Sean,

The enclosed plats for the Jacquelyn Estates Subdivision has the following Bonus density calculations:

14.517 acres

2.348 acres of roadway (includes 2200 S. dedication)

6.102 acres total lots

5.9516 acres open space (does not include circle C.A.)

14.517 acres - 2.348 acres road = 12.169 acres developable acres.

12.169 ac X 43560 = 530,081 sq. ft. / 40,000 X 1.5 = 19 cluster lots

Cluster subd:	15%
12.169 acres X 30% open space req. = 3.650 acres	
5.9516 acres open space in subd = 49% open space (5% bonus for ea 5% excess area)	19%
Affordable Housing:	16%
total:	50%

sincerely,

Dallas Buttars

LEGEND

-  CENTER LINE
-  IMPROVED GRANITE CURBSIDE
-  EXISTING FENCE LINE
-  EXISTING WATER LINE
-  EXISTING SANITARY LINE
-  EXISTING SEWER MAIN
-  EXISTING SEWER SERVICE
-  EXISTING STORM MAIN
-  EXISTING STORM SERVICE
-  EXISTING EASEMENT
-  EXISTING EASEMENT
-  EXISTING EASEMENT
-  EXISTING EASEMENT
-  EXISTING EASEMENT
-  EXISTING EASEMENT
-  EXISTING EASEMENT
-  EXISTING EASEMENT
-  EXISTING EASEMENT
-  EXISTING EASEMENT
-  EXISTING EASEMENT
-  EXISTING EASEMENT
-  EXISTING EASEMENT
-  EXISTING EASEMENT
-  EXISTING EASEMENT
-  EXISTING EASEMENT
-  EXISTING EASEMENT
-  EXISTING EASEMENT
-  EXISTING EASEMENT
-  EXISTING EASEMENT
-  EXISTING EASEMENT
-  EXISTING EASEMENT
-  EXISTING EASEMENT
-  EXISTING EASEMENT
-  EXISTING EASEMENT
-  EXISTING EASEMENT
-  EXISTING EASEMENT
-  EXISTING EASEMENT
-  EXISTING EASEMENT
-  EXISTING EASEMENT
-  EXISTING EASEMENT
-  EXISTING EASEMENT
-  EXISTING EASEMENT
-  EXISTING EASEMENT
-  EXISTING EASEMENT
-  EXISTING EASEMENT
-  EXISTING EASEMENT
-  EXISTING EASEMENT

- GENERAL NOTES**
- 1. ALL CONSTRUCTION SHALL BE IN ACCORDANCE WITH THE LATEST EDITIONS OF THE CITY ENGINEERING SPECIFICATIONS AND THE COUNTY SPECIFICATIONS.
- 2. THE CONTRACTOR SHALL BE RESPONSIBLE FOR OBTAINING ALL NECESSARY PERMITS AND APPROVALS FROM THE LOCAL JURISDICTIONS.
- 3. ALL UTILITIES SHOWN ON THIS PLAN SHALL BE THE PROPERTY OF THE UTILITY COMPANY AND SHALL BE MAINTAINED AT ALL TIMES.
- 4. THE CONTRACTOR SHALL PROTECT ALL UTILITIES AND STRUCTURES SHOWN ON THIS PLAN AND SHALL BE RESPONSIBLE FOR ANY DAMAGE TO SAME.
- 5. THE CONTRACTOR SHALL MAINTAIN ACCESS TO ALL ADJACENT PROPERTIES AT ALL TIMES.
- 6. THE CONTRACTOR SHALL BE RESPONSIBLE FOR THE PROTECTION AND MAINTENANCE OF ALL EXISTING STRUCTURES AND UTILITIES.
- 7. THE CONTRACTOR SHALL BE RESPONSIBLE FOR THE PROTECTION AND MAINTENANCE OF ALL EXISTING CURBSIDE AND STORM MAINS.
- 8. THE CONTRACTOR SHALL BE RESPONSIBLE FOR THE PROTECTION AND MAINTENANCE OF ALL EXISTING SEWER MAINS AND SERVICES.
- 9. THE CONTRACTOR SHALL BE RESPONSIBLE FOR THE PROTECTION AND MAINTENANCE OF ALL EXISTING WATER MAINS AND SERVICES.
- 10. THE CONTRACTOR SHALL BE RESPONSIBLE FOR THE PROTECTION AND MAINTENANCE OF ALL EXISTING EASEMENTS.
- 11. THE CONTRACTOR SHALL BE RESPONSIBLE FOR THE PROTECTION AND MAINTENANCE OF ALL EXISTING FENCE LINES.
- 12. THE CONTRACTOR SHALL BE RESPONSIBLE FOR THE PROTECTION AND MAINTENANCE OF ALL EXISTING GRANITE CURBSIDE.
- 13. THE CONTRACTOR SHALL BE RESPONSIBLE FOR THE PROTECTION AND MAINTENANCE OF ALL EXISTING STORM MAINS AND SERVICES.
- 14. THE CONTRACTOR SHALL BE RESPONSIBLE FOR THE PROTECTION AND MAINTENANCE OF ALL EXISTING SEWER MAINS AND SERVICES.
- 15. THE CONTRACTOR SHALL BE RESPONSIBLE FOR THE PROTECTION AND MAINTENANCE OF ALL EXISTING WATER MAINS AND SERVICES.
- 16. THE CONTRACTOR SHALL BE RESPONSIBLE FOR THE PROTECTION AND MAINTENANCE OF ALL EXISTING EASEMENTS.
- 17. THE CONTRACTOR SHALL BE RESPONSIBLE FOR THE PROTECTION AND MAINTENANCE OF ALL EXISTING FENCE LINES.
- 18. THE CONTRACTOR SHALL BE RESPONSIBLE FOR THE PROTECTION AND MAINTENANCE OF ALL EXISTING GRANITE CURBSIDE.
- 19. THE CONTRACTOR SHALL BE RESPONSIBLE FOR THE PROTECTION AND MAINTENANCE OF ALL EXISTING STORM MAINS AND SERVICES.
- 20. THE CONTRACTOR SHALL BE RESPONSIBLE FOR THE PROTECTION AND MAINTENANCE OF ALL EXISTING SEWER MAINS AND SERVICES.
- 21. THE CONTRACTOR SHALL BE RESPONSIBLE FOR THE PROTECTION AND MAINTENANCE OF ALL EXISTING WATER MAINS AND SERVICES.
- 22. THE CONTRACTOR SHALL BE RESPONSIBLE FOR THE PROTECTION AND MAINTENANCE OF ALL EXISTING EASEMENTS.
- 23. THE CONTRACTOR SHALL BE RESPONSIBLE FOR THE PROTECTION AND MAINTENANCE OF ALL EXISTING FENCE LINES.
- 24. THE CONTRACTOR SHALL BE RESPONSIBLE FOR THE PROTECTION AND MAINTENANCE OF ALL EXISTING GRANITE CURBSIDE.
- 25. THE CONTRACTOR SHALL BE RESPONSIBLE FOR THE PROTECTION AND MAINTENANCE OF ALL EXISTING STORM MAINS AND SERVICES.
- 26. THE CONTRACTOR SHALL BE RESPONSIBLE FOR THE PROTECTION AND MAINTENANCE OF ALL EXISTING SEWER MAINS AND SERVICES.
- 27. THE CONTRACTOR SHALL BE RESPONSIBLE FOR THE PROTECTION AND MAINTENANCE OF ALL EXISTING WATER MAINS AND SERVICES.
- 28. THE CONTRACTOR SHALL BE RESPONSIBLE FOR THE PROTECTION AND MAINTENANCE OF ALL EXISTING EASEMENTS.
- 29. THE CONTRACTOR SHALL BE RESPONSIBLE FOR THE PROTECTION AND MAINTENANCE OF ALL EXISTING FENCE LINES.
- 30. THE CONTRACTOR SHALL BE RESPONSIBLE FOR THE PROTECTION AND MAINTENANCE OF ALL EXISTING GRANITE CURBSIDE.

STORM WATER DETENTION PREVENTION

1. THE CONTRACTOR SHALL BE RESPONSIBLE FOR THE PROTECTION AND MAINTENANCE OF ALL EXISTING STORM MAINS AND SERVICES.

2. THE CONTRACTOR SHALL BE RESPONSIBLE FOR THE PROTECTION AND MAINTENANCE OF ALL EXISTING SEWER MAINS AND SERVICES.

3. THE CONTRACTOR SHALL BE RESPONSIBLE FOR THE PROTECTION AND MAINTENANCE OF ALL EXISTING WATER MAINS AND SERVICES.

4. THE CONTRACTOR SHALL BE RESPONSIBLE FOR THE PROTECTION AND MAINTENANCE OF ALL EXISTING EASEMENTS.

5. THE CONTRACTOR SHALL BE RESPONSIBLE FOR THE PROTECTION AND MAINTENANCE OF ALL EXISTING FENCE LINES.

6. THE CONTRACTOR SHALL BE RESPONSIBLE FOR THE PROTECTION AND MAINTENANCE OF ALL EXISTING GRANITE CURBSIDE.

7. THE CONTRACTOR SHALL BE RESPONSIBLE FOR THE PROTECTION AND MAINTENANCE OF ALL EXISTING STORM MAINS AND SERVICES.

8. THE CONTRACTOR SHALL BE RESPONSIBLE FOR THE PROTECTION AND MAINTENANCE OF ALL EXISTING SEWER MAINS AND SERVICES.

9. THE CONTRACTOR SHALL BE RESPONSIBLE FOR THE PROTECTION AND MAINTENANCE OF ALL EXISTING WATER MAINS AND SERVICES.

10. THE CONTRACTOR SHALL BE RESPONSIBLE FOR THE PROTECTION AND MAINTENANCE OF ALL EXISTING EASEMENTS.

11. THE CONTRACTOR SHALL BE RESPONSIBLE FOR THE PROTECTION AND MAINTENANCE OF ALL EXISTING FENCE LINES.

12. THE CONTRACTOR SHALL BE RESPONSIBLE FOR THE PROTECTION AND MAINTENANCE OF ALL EXISTING GRANITE CURBSIDE.

13. THE CONTRACTOR SHALL BE RESPONSIBLE FOR THE PROTECTION AND MAINTENANCE OF ALL EXISTING STORM MAINS AND SERVICES.

14. THE CONTRACTOR SHALL BE RESPONSIBLE FOR THE PROTECTION AND MAINTENANCE OF ALL EXISTING SEWER MAINS AND SERVICES.

15. THE CONTRACTOR SHALL BE RESPONSIBLE FOR THE PROTECTION AND MAINTENANCE OF ALL EXISTING WATER MAINS AND SERVICES.

16. THE CONTRACTOR SHALL BE RESPONSIBLE FOR THE PROTECTION AND MAINTENANCE OF ALL EXISTING EASEMENTS.

17. THE CONTRACTOR SHALL BE RESPONSIBLE FOR THE PROTECTION AND MAINTENANCE OF ALL EXISTING FENCE LINES.

18. THE CONTRACTOR SHALL BE RESPONSIBLE FOR THE PROTECTION AND MAINTENANCE OF ALL EXISTING GRANITE CURBSIDE.

19. THE CONTRACTOR SHALL BE RESPONSIBLE FOR THE PROTECTION AND MAINTENANCE OF ALL EXISTING STORM MAINS AND SERVICES.

20. THE CONTRACTOR SHALL BE RESPONSIBLE FOR THE PROTECTION AND MAINTENANCE OF ALL EXISTING SEWER MAINS AND SERVICES.

21. THE CONTRACTOR SHALL BE RESPONSIBLE FOR THE PROTECTION AND MAINTENANCE OF ALL EXISTING WATER MAINS AND SERVICES.

22. THE CONTRACTOR SHALL BE RESPONSIBLE FOR THE PROTECTION AND MAINTENANCE OF ALL EXISTING EASEMENTS.

23. THE CONTRACTOR SHALL BE RESPONSIBLE FOR THE PROTECTION AND MAINTENANCE OF ALL EXISTING FENCE LINES.

24. THE CONTRACTOR SHALL BE RESPONSIBLE FOR THE PROTECTION AND MAINTENANCE OF ALL EXISTING GRANITE CURBSIDE.

25. THE CONTRACTOR SHALL BE RESPONSIBLE FOR THE PROTECTION AND MAINTENANCE OF ALL EXISTING STORM MAINS AND SERVICES.

26. THE CONTRACTOR SHALL BE RESPONSIBLE FOR THE PROTECTION AND MAINTENANCE OF ALL EXISTING SEWER MAINS AND SERVICES.

27. THE CONTRACTOR SHALL BE RESPONSIBLE FOR THE PROTECTION AND MAINTENANCE OF ALL EXISTING WATER MAINS AND SERVICES.

28. THE CONTRACTOR SHALL BE RESPONSIBLE FOR THE PROTECTION AND MAINTENANCE OF ALL EXISTING EASEMENTS.

29. THE CONTRACTOR SHALL BE RESPONSIBLE FOR THE PROTECTION AND MAINTENANCE OF ALL EXISTING FENCE LINES.

30. THE CONTRACTOR SHALL BE RESPONSIBLE FOR THE PROTECTION AND MAINTENANCE OF ALL EXISTING GRANITE CURBSIDE.

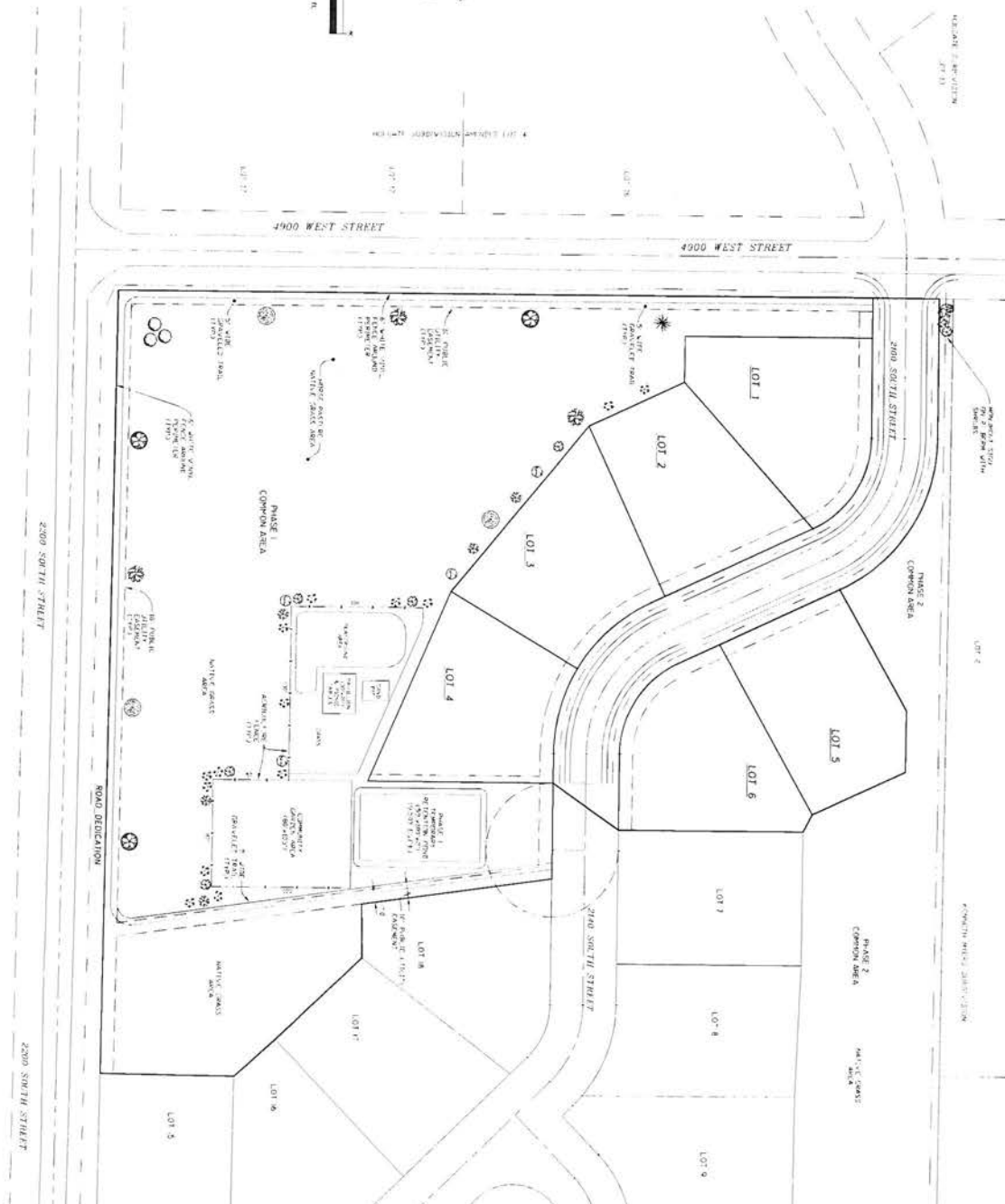

1. 24/24-2014.A	2. SHEET NO.	3. SHEET OF	4. DATE	5. SCALE	6. LANDSCAPING SERVICE	7. DEVELOPER	8. JACOUELYN ESTATES SUBDIVISION	9. SHEET
1	1	1	03-22-2014	AS SHOWN	LANDSCAPING SERVICE A COMPLETE LANDSCAPING SERVICE 4646 S. W. 4th St. West, Miramar, FL 33187 Phone: 305-731-4178, Fax: 305-731-4178 www.landscaping.com	ERIK S. ANDERSON, P.E.	LOCATED IN THE NW 1/4 OF SECTION 29, T6N, R22W, S14R31N MIAMI COUNTY, FLORIDA	1 1

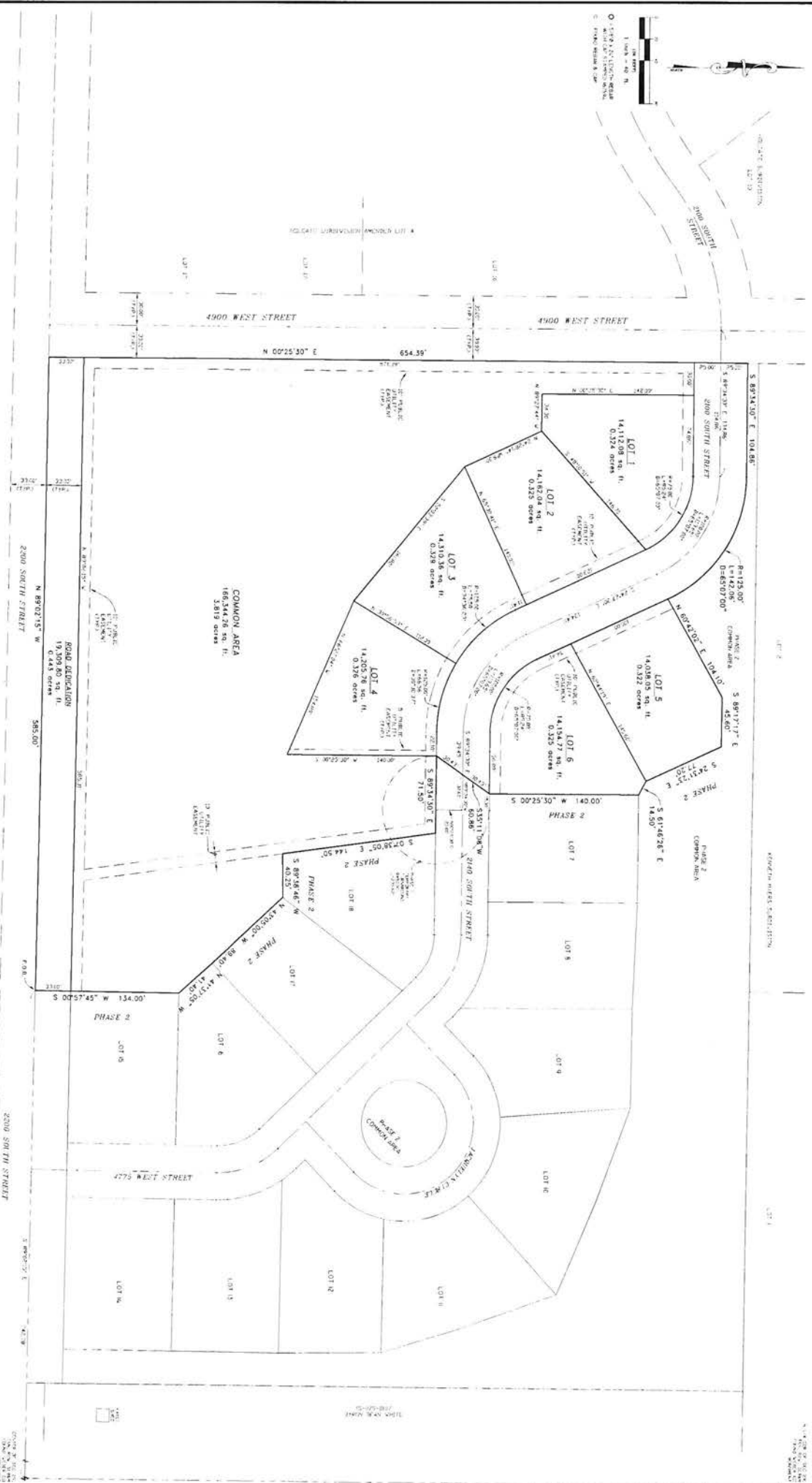
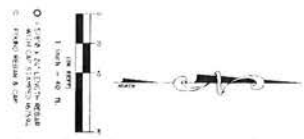

1	24-03-2014 L.A.	1	24-03-2014
2	24-03-2014 L.A.	2	24-03-2014
3	24-03-2014 L.A.	3	24-03-2014
4	24-03-2014 L.A.	4	24-03-2014

PREPARED BY:	DATE:
CHECKED BY:	SCALE:
JOB NO.:	



LANDMARK SURVEYING, INC.
 A COMPLETE LANDSURVEYING SERVICE
 4440 S. 2000 W. AVENUE, WEST HAVEN, UTAH 84401
 PHONE: 801-734-4075 FAX: 801-731-8908
 LANDMARKSURVEYING.COM

PRELIMINARY PLAN
 IN VICTORIA CRANSTANDING PRT 501 (240-8950)

JACQUELYN ESTATES SUBDIVISION
 LOCATED IN THE NW 1/4 OF SECTION 29 T10N, R2W, S1885N
 WEBER COUNTY, UTAH

LEGEND

- 1. CENTERLINE OF ROAD
- 2. PROPERTY BOUNDARY
- 3. EXISTING SIDEWALK
- 4. EXISTING DRIVEWAY
- 5. EXISTING DRIVEWAY
- 6. EXISTING DRIVEWAY
- 7. EXISTING DRIVEWAY
- 8. EXISTING DRIVEWAY
- 9. EXISTING DRIVEWAY
- 10. EXISTING DRIVEWAY
- 11. EXISTING DRIVEWAY
- 12. EXISTING DRIVEWAY
- 13. EXISTING DRIVEWAY
- 14. EXISTING DRIVEWAY
- 15. EXISTING DRIVEWAY
- 16. EXISTING DRIVEWAY
- 17. EXISTING DRIVEWAY
- 18. EXISTING DRIVEWAY
- 19. EXISTING DRIVEWAY
- 20. EXISTING DRIVEWAY
- 21. EXISTING DRIVEWAY
- 22. EXISTING DRIVEWAY
- 23. EXISTING DRIVEWAY
- 24. EXISTING DRIVEWAY
- 25. EXISTING DRIVEWAY
- 26. EXISTING DRIVEWAY
- 27. EXISTING DRIVEWAY
- 28. EXISTING DRIVEWAY
- 29. EXISTING DRIVEWAY
- 30. EXISTING DRIVEWAY
- 31. EXISTING DRIVEWAY
- 32. EXISTING DRIVEWAY
- 33. EXISTING DRIVEWAY
- 34. EXISTING DRIVEWAY
- 35. EXISTING DRIVEWAY
- 36. EXISTING DRIVEWAY
- 37. EXISTING DRIVEWAY
- 38. EXISTING DRIVEWAY
- 39. EXISTING DRIVEWAY
- 40. EXISTING DRIVEWAY
- 41. EXISTING DRIVEWAY
- 42. EXISTING DRIVEWAY
- 43. EXISTING DRIVEWAY
- 44. EXISTING DRIVEWAY
- 45. EXISTING DRIVEWAY
- 46. EXISTING DRIVEWAY
- 47. EXISTING DRIVEWAY
- 48. EXISTING DRIVEWAY
- 49. EXISTING DRIVEWAY
- 50. EXISTING DRIVEWAY
- 51. EXISTING DRIVEWAY
- 52. EXISTING DRIVEWAY
- 53. EXISTING DRIVEWAY
- 54. EXISTING DRIVEWAY
- 55. EXISTING DRIVEWAY
- 56. EXISTING DRIVEWAY
- 57. EXISTING DRIVEWAY
- 58. EXISTING DRIVEWAY
- 59. EXISTING DRIVEWAY
- 60. EXISTING DRIVEWAY
- 61. EXISTING DRIVEWAY
- 62. EXISTING DRIVEWAY
- 63. EXISTING DRIVEWAY
- 64. EXISTING DRIVEWAY
- 65. EXISTING DRIVEWAY
- 66. EXISTING DRIVEWAY
- 67. EXISTING DRIVEWAY
- 68. EXISTING DRIVEWAY
- 69. EXISTING DRIVEWAY
- 70. EXISTING DRIVEWAY
- 71. EXISTING DRIVEWAY
- 72. EXISTING DRIVEWAY
- 73. EXISTING DRIVEWAY
- 74. EXISTING DRIVEWAY
- 75. EXISTING DRIVEWAY
- 76. EXISTING DRIVEWAY
- 77. EXISTING DRIVEWAY
- 78. EXISTING DRIVEWAY
- 79. EXISTING DRIVEWAY
- 80. EXISTING DRIVEWAY
- 81. EXISTING DRIVEWAY
- 82. EXISTING DRIVEWAY
- 83. EXISTING DRIVEWAY
- 84. EXISTING DRIVEWAY
- 85. EXISTING DRIVEWAY
- 86. EXISTING DRIVEWAY
- 87. EXISTING DRIVEWAY
- 88. EXISTING DRIVEWAY
- 89. EXISTING DRIVEWAY
- 90. EXISTING DRIVEWAY
- 91. EXISTING DRIVEWAY
- 92. EXISTING DRIVEWAY
- 93. EXISTING DRIVEWAY
- 94. EXISTING DRIVEWAY
- 95. EXISTING DRIVEWAY
- 96. EXISTING DRIVEWAY
- 97. EXISTING DRIVEWAY
- 98. EXISTING DRIVEWAY
- 99. EXISTING DRIVEWAY
- 100. EXISTING DRIVEWAY

GENERAL NOTES

1. ALL CONSTRUCTION SHALL BE IN ACCORDANCE WITH THE LATEST EDITIONS OF THE ILLINOIS CONSTRUCTION CODE, THE ILLINOIS STATE BOARD OF CONSTRUCTION, AND THE ILLINOIS DEPARTMENT OF TRANSPORTATION. THE ILLINOIS DEPARTMENT OF TRANSPORTATION SHALL BE CONSULTED FOR ALL CONSTRUCTION OF HIGHWAYS AND BRIDGES.

2. ALL CONSTRUCTION SHALL BE IN ACCORDANCE WITH THE LATEST EDITIONS OF THE ILLINOIS CONSTRUCTION CODE, THE ILLINOIS STATE BOARD OF CONSTRUCTION, AND THE ILLINOIS DEPARTMENT OF TRANSPORTATION. THE ILLINOIS DEPARTMENT OF TRANSPORTATION SHALL BE CONSULTED FOR ALL CONSTRUCTION OF HIGHWAYS AND BRIDGES.

3. ALL CONSTRUCTION SHALL BE IN ACCORDANCE WITH THE LATEST EDITIONS OF THE ILLINOIS CONSTRUCTION CODE, THE ILLINOIS STATE BOARD OF CONSTRUCTION, AND THE ILLINOIS DEPARTMENT OF TRANSPORTATION. THE ILLINOIS DEPARTMENT OF TRANSPORTATION SHALL BE CONSULTED FOR ALL CONSTRUCTION OF HIGHWAYS AND BRIDGES.

4. ALL CONSTRUCTION SHALL BE IN ACCORDANCE WITH THE LATEST EDITIONS OF THE ILLINOIS CONSTRUCTION CODE, THE ILLINOIS STATE BOARD OF CONSTRUCTION, AND THE ILLINOIS DEPARTMENT OF TRANSPORTATION. THE ILLINOIS DEPARTMENT OF TRANSPORTATION SHALL BE CONSULTED FOR ALL CONSTRUCTION OF HIGHWAYS AND BRIDGES.

5. ALL CONSTRUCTION SHALL BE IN ACCORDANCE WITH THE LATEST EDITIONS OF THE ILLINOIS CONSTRUCTION CODE, THE ILLINOIS STATE BOARD OF CONSTRUCTION, AND THE ILLINOIS DEPARTMENT OF TRANSPORTATION. THE ILLINOIS DEPARTMENT OF TRANSPORTATION SHALL BE CONSULTED FOR ALL CONSTRUCTION OF HIGHWAYS AND BRIDGES.

STORM WATER POLLUTION PREVENTION

1. THE DEVELOPER SHALL BE RESPONSIBLE FOR THE DESIGN AND CONSTRUCTION OF ALL STORM WATER POLLUTION PREVENTION MEASURES. THE MEASURES SHALL BE DESIGNED TO PREVENT POLLUTION OF ADJACENT WATER BODIES AND TO PROTECT THE QUALITY OF THE RECEIVING WATER BODY.

2. THE MEASURES SHALL BE DESIGNED TO PREVENT POLLUTION OF ADJACENT WATER BODIES AND TO PROTECT THE QUALITY OF THE RECEIVING WATER BODY. THE MEASURES SHALL BE DESIGNED TO PREVENT POLLUTION OF ADJACENT WATER BODIES AND TO PROTECT THE QUALITY OF THE RECEIVING WATER BODY.

3. THE MEASURES SHALL BE DESIGNED TO PREVENT POLLUTION OF ADJACENT WATER BODIES AND TO PROTECT THE QUALITY OF THE RECEIVING WATER BODY. THE MEASURES SHALL BE DESIGNED TO PREVENT POLLUTION OF ADJACENT WATER BODIES AND TO PROTECT THE QUALITY OF THE RECEIVING WATER BODY.

4. THE MEASURES SHALL BE DESIGNED TO PREVENT POLLUTION OF ADJACENT WATER BODIES AND TO PROTECT THE QUALITY OF THE RECEIVING WATER BODY. THE MEASURES SHALL BE DESIGNED TO PREVENT POLLUTION OF ADJACENT WATER BODIES AND TO PROTECT THE QUALITY OF THE RECEIVING WATER BODY.

5. THE MEASURES SHALL BE DESIGNED TO PREVENT POLLUTION OF ADJACENT WATER BODIES AND TO PROTECT THE QUALITY OF THE RECEIVING WATER BODY. THE MEASURES SHALL BE DESIGNED TO PREVENT POLLUTION OF ADJACENT WATER BODIES AND TO PROTECT THE QUALITY OF THE RECEIVING WATER BODY.

SCALES

1. 1" = 100'

2. 1" = 200'

3. 1" = 400'

4. 1" = 800'

5. 1" = 1600'

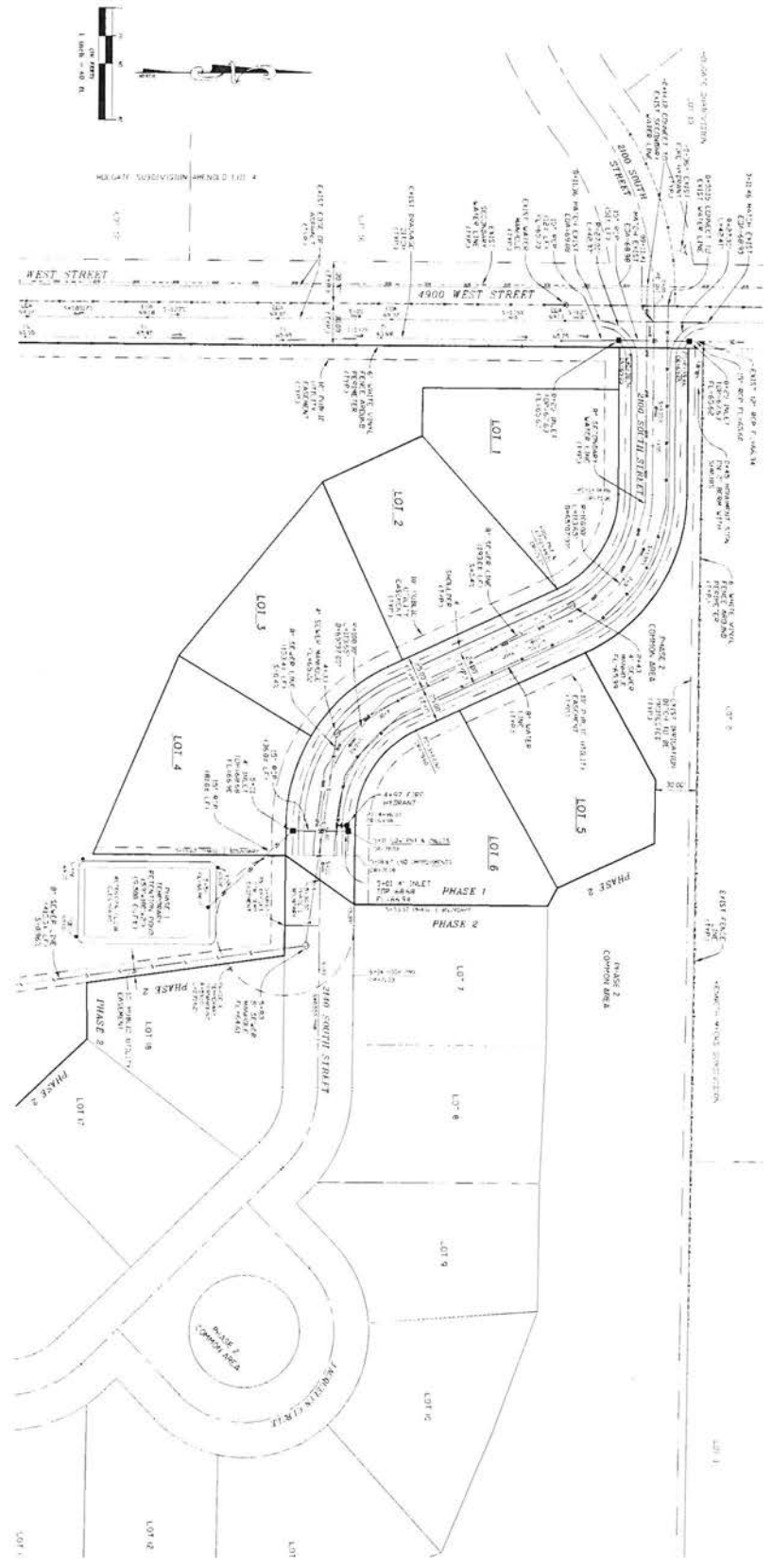

2100 SOUTH STREET

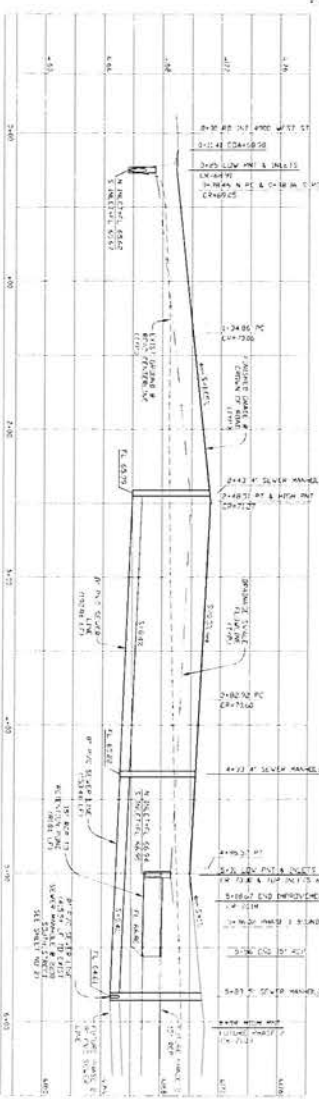

1. DATE: 03-21-2014	2. SHEET: 1 OF 2	3. PROJECT: JACOUELYN ESTATES SUBDIVISION
2. CHECKED BY: J.S.	3. SCALE: AS SHOWN	4. DRAWN BY: J.S.
3. DATE: 03-21-2014	4. PROJECT: JACOUELYN ESTATES SUBDIVISION	5. SHEET: 1 OF 2
4. CHECKED BY: J.S.	5. SCALE: AS SHOWN	6. DRAWN BY: J.S.
5. DATE: 03-21-2014	6. PROJECT: JACOUELYN ESTATES SUBDIVISION	7. SHEET: 1 OF 2
6. CHECKED BY: J.S.	7. SCALE: AS SHOWN	8. DRAWN BY: J.S.
7. DATE: 03-21-2014	8. PROJECT: JACOUELYN ESTATES SUBDIVISION	9. SHEET: 1 OF 2
8. CHECKED BY: J.S.	9. SCALE: AS SHOWN	10. DRAWN BY: J.S.



IMPROVEMENT PLAN

DEVELOPER: CRAND STANBING PH: 801-540-8190

JACOUELYN ESTATES SUBDIVISION

LOCATED IN THE NW 1/4 OF SECTION 29 T.6N. R.20W. S.183AN

WEBER COUNTY, UTAH

CHAPTER 3. CLUSTER SUBDIVISIONS

Sec. 108-3-1. Intent.

The intent of this chapter is to encourage the creation and permanent protection of open space, to preserve the rural character and natural beauty of unincorporated Weber County, as called for by the county's general plans. It is not the intent of this chapter to create open space subdivisions with lots sprawled over large areas, or strung out along roadways.

(Ord. of 1956, § 22B-1; Ord. No. 10-65; Ord. No. 8-72; Ord. No. 2000-18; Ord. No. 2001-34; Ord. No. 8-2006; Ord. No. 2009-15)

Sec. 108-3-2. General regulations.

The planning commission may approve a reduction in the minimum lot area required for a lot in a subdivision provided the provisions of this chapter and title 106, the Weber County subdivision ordinance are met. A cluster subdivision shall meet the requirements of the Weber County Land Use Code, and shall ensure proper use and maintenance of open space and open space facilities and shall result in a development superior to a conventional development in terms of its benefits to future owners of the subdivision, surrounding residents and the general public.

(Ord. of 1956, § 22B-2; Ord. No. 10-65; Ord. No. 8-72; Ord. No. 2000-18; Ord. No. 2001-34; Ord. No. 8-2006; Ord. No. 2009-15)

Sec. 108-3-3. Lot area regulations.

(a) To encourage quality open space that promotes the intent of this chapter, the minimum percent of a cluster subdivision left in open space shall be as follows:

(1) In the Forest Zone F-40, a minimum of 90 percent of any cluster subdivision shall be preserved as permanent open space.

(2) In the Forest Zones F-10 and F-5, a minimum of 80 percent of any cluster subdivision shall be preserved as permanent open space.

(3) In the Agricultural Valley Zone AV-3, and the Forest Valley Zone FV-3, a minimum of 60 percent of any cluster subdivision shall be preserved as permanent open space.

(4) In all other zones, a minimum of 30 percent of any cluster subdivision shall be preserved as permanent open space.

(b) The minimum lot area in a cluster subdivision shall be 10,000 square feet unless approved as part of a planned residential unit development.

(Ord. of 1956, § 22B-3; Ord. No. 10-65; Ord. No. 8-72; Ord. No. 2000-18; Ord. No. 2001-34; Ord. No. 8-2006; Ord. No. 2009-15)

Sec. 108-3-4. Width, yard and height regulations.

(a) Yard and height regulations shall be the same as for the zone in which the cluster subdivision is located except as noted below. The minimum lot width may be reduced below the width normally required in the zone in which the cluster subdivision is located as follows:

(1) In the Forest Zone F-40, and F-10, the lot width may be reduced to 150 feet.

(2) In the Forest Zone F-5, the lot width may be reduced to 100 feet.

(3) In the Agricultural Zones A-1, A-2, and A-3, a minimum frontage of 100 feet is required.

(4) In the Forest Residential FR-1, and FV-3 Zone, a minimum frontage of 100 feet is required.

(5) In the Residential Estates RE-20 Zone, a minimum frontage of 80 feet is required.

(6) In the Residential Estates RE-15 Zone, a minimum frontage of 70 feet is required.

(b) Where lots are reduced to 20,000 square feet or less, the front yard setback may be reduced to 25 feet and the side yard setback to a minimum of eight feet with the total of the two side yards not less than 18 feet.

(c) The lot width and yard reductions listed in this section are the maximum reduction allowed. Creating greater lot width reductions calculated by combining the reductions in this section with others permitted in the Land Use Code is not permitted.

(Ord. of 1956, § 22B-4; Ord. No. 10-65; Ord. No. 8-72; Ord. No. 2000-18; Ord. No. 2001-34; Ord. No. 8-2006; Ord. No. 2009-15)

Sec. 108-3-5. Additional design standards and requirements.

Cluster subdivisions shall be designed and platted in conformance to the goals and objectives of the county's general plans.

(1) Lots in cluster subdivisions shall be clustered into contiguous groups of not less than five lots and no more than three clusters per 60 lots. All clusters of lots shall be contained within an area not to exceed 70 percent of the total area of the subdivision.

(2) Streets shall be designed to take advantage of and provide visual access to open space vistas created by the subdivision's permanently preserved open space and the county's natural beauty and rural ambiance.

(3) Areas designated as floodplain by the Federal Emergency Management Agency and within required river and stream corridor setbacks shall be left as open space.

(4) There shall be permanently reserved within the subdivision for recreation and/or open space, parcels of land whose total "net developable area" is not less than the amount by which the areas of the residential lots are reduced below the minimum area normally required in the zone in which the cluster subdivision is located. The term "net developable area" is land that is not excluded from use in density calculations or deemed undevelopable by this or any other county, state, or federal law, ordinance or regulation. The area within existing and proposed public and private road right-of-ways shall not be counted as "net developable area."

(5) Open space used in density calculations shall be a minimum of three contiguous acres in the RE-20, RE-15, A-1, A-2, and A-3 zones, and five contiguous acres in all other zones where permitted.

(Ord. of 1956, § 22B-5; Ord. No. 10-65; Ord. No. 8-72; Ord. No. 2000-18; Ord. No. 2001-34; Ord. No. 8-2006; Ord. No. 2009-15)

Sec. 108-3-6. Bonus density.

(a) In the Forest Zones F-40, and F-10, a maximum bonus density of 20 percent may be approved and shall be based on an accumulation of the following:

(1) Developing a cluster subdivision that the planning commission determines meets the intent of this chapter, a five percent bonus may be granted.

(2) Providing road stubs to adjacent property where the planning commission determines that streets are needed to provide for current or future traffic circulation up to a five percent bonus density may be granted.

(3) Provides access to public lands; up to a five percent bonus density may be granted.

(4) The common area is open to the public and provides amenities to the general public such as trails; up to a five percent bonus density may be granted.

(5) Protection of areas that are identified by the state division of wildlife resources as critical wildlife habit; up to a ten percent bonus density may be granted in the Agricultural Valley Zone AV-3, Forest Zone F-5 and the Forest Valley Zone FV-3: a

maximum bonus density of 30 percent may be approved and shall be based on an accumulation of the following:

- a. Developing a cluster subdivision that the planning commission determines meets the intent of this chapter, a ten percent bonus may be granted.
- b. For each five percent of open space preserved in the subdivision in excess of the minimum required by this chapter, up to a five percent bonus density may be granted.
- c. Providing road stubs to adjacent property where the planning commission determines that streets are needed to provide for current or future traffic circulation; a five percent bonus density may be granted per stub up to a maximum of ten percent.
- d. Provides access to public lands; up to a five percent bonus density may be granted.
- e. The common area is open to the public and provides amenities to the general public such as trail; up to a ten percent bonus density may be granted.
- f. Ten percent of the lots and homes are permanently set aside for affordable housing (as outlined by the Affordable Housing Act of 1990), up to a ten percent bonus density may be granted.
- g. Preservation of an agricultural parcel with an agricultural preservation plan approved by the planning commission and an agricultural preservation easement recorded on the parcel:
 1. Between ten and 20 acres, up to a ten percent bonus density may be granted.
 2. 20 acres or larger, up to a 15 percent bonus density may be granted.
- h. Preservation of historical sites and buildings (barns, homes, trails, or other structures); up to a five percent bonus density may be granted.
- i. Development of excess sewage treatment capacity; up to a five percent bonus density may be granted.
- j. Preservation in open space of areas that are identified by the state division of wildlife resources as providing valuable wildlife habit; up to a ten percent bonus density may be granted.
- k. Preservation in open space of areas that are identified by the state division of wildlife resources as critical wildlife habit; up to a 15 percent bonus density may be granted.
- l. Open space is contiguous to permanently preserved open space on an adjoining property; up to a five percent bonus density may be granted.
- m. Preserving in open space a 300-foot setback from the high water mark of Pineview Reservoir; up to ten percent bonus density may be granted.

(b) In the Agricultural Zones A-1, A-2 and A-3, up to a maximum bonus density of 50 percent may be approved and shall be based on an accumulation of the following:

(1) Developing a cluster subdivision that the planning commission determines meets the intent of this chapter: a 15 percent bonus may be granted.

(2) For each five percent of open space preserved in the subdivision in excess of the minimum required by this chapter: up to a five percent bonus density may be granted.

(3) Providing road stubs to adjacent property where the planning commission determines that streets are needed to provide for current or future traffic circulation: a five percent bonus density may be granted per stub up to a maximum of ten percent.

(4) Provides access to public lands: up to a ten percent bonus density may be granted.

(5) The common area is open to the public and provides amenities to the general public such as trail: up to a 15 percent bonus density may be granted.

(6) Ten percent of the lots and homes are permanently set aside for affordable housing (as outlined by the Affordable Housing Act of 1990): up to a 25 percent bonus density may be granted.

(7) Preservation of an agricultural parcel with an agricultural preservation plan approved by the planning commission and an agricultural preservation easement recorded on the parcel:

a. Between ten and 20 acres: up to a 15 percent bonus density may be granted.

b. 20 acres or larger: up to a 20 percent bonus density may be granted.

(8) Preservation of historical sites and buildings (barns, homes, trails, or other structures): up to a five percent bonus density may be granted.

(9) Development of excess sewage treatment capacity: up to a five percent bonus density may be granted.

(10) Preservation in open space of areas that are identified by the state division of wildlife resources as providing valuable wildlife habit: up to a ten percent bonus density may be granted.

(11) Preservation in open space of areas that are identified by the state division of wildlife resources as critical wildlife habit: up to a 15 percent bonus density may be granted.

(12) Open space is contiguous to permanently preserved open space on an adjoining property: up to a 20 percent bonus density may be granted.

(Ord. of 1956, § 22B-6; Ord. No. 10-65; Ord. No. 8-72; Ord. No. 2000-18; Ord. No. 2001-34; Ord. No. 8-2006; Ord. No. 2009-15)

Sec. 108-3-7. Open space preservation.

(a) Open space shall be maintained in accordance with an open space preservation, maintenance and improvements plan submitted by the developer and approved plan by the planning commission and county commission. The plan shall detail the intended use of the open space and any proposed improvements to be placed in the open space.

(b) To ensure open space parcels are permanently reserved and maintained, the developers/property owners shall prior to recording of the final plat of the proposed cluster subdivision:

(1) Grant and convey to the county an easement for open space over the required open space parcels; and

(2) Grant and convey to the lot owners association of the proposed cluster subdivision an easement for open space over the required open space parcels.

(c) If a bonus density is granted for the preservation of critical or valuable wildlife habitat, a wildlife habitat easement shall be offered to state division of wildlife resources. Bonus densities for critical or valuable wildlife habitat shall be based on a review of the subdivision by the state division of wildlife resources and there finding that the subdivision preserves critical or valuable wildlife habitat.

(d) If a bonus density is granted for affordable housing, then the affordable housing lots shall be identified on the subdivision plat. A deed restriction shall also be recorded on these lots limiting the sale, or rental of the homes to a household with incomes at or below 80 percent of the county median income.

(e) If an agricultural preservation easement is proposed, the agricultural parcel shall be a contiguous parcel containing at minimum ten acres and a copy of an approved agricultural preservation agreement shall be submitted and recorded with the final plat.

(f) The required open space may be owned by up to two lot owners in the subdivision, in parcels of not less than ten acres each and provided that no structures or accessory structures be built in the open space with the exception of agricultural buildings approved as part of the agricultural preservation plan.

(g) Guarantee of common open space improvements. As assurance of completion of common open space improvements, the subdivider shall be required to file with the county commissioners an approved financial guarantee, guaranteeing completion in a manner satisfactory to the county commissioners, within two years of such filing.

(h) The planning commission may place additional conditions or restrictions it deems necessary to ensure development and maintenance of the desired character, including plans for deposition or re use of property if the open space use is not maintained in the manner agreed upon or is abandoned by the owners.

(Ord. of 1956, § 22B-7; Ord. No. 10-65; Ord. No. 8-72; Ord. No. 2000-18; Ord. No. 2001-34; Ord. No. 8-2006; Ord. No. 2009-15)

Sec. 108-3-8. Owner association required.

As assurance of maintenance of the common open space and other improvements where so required, the subdivider shall cause to be formed, prior to the recording of the final plat, a lot owners' association and shall establish articles of incorporation of the association, filed at the state department of commerce, bylaws and covenants outlining the purpose, organization and operation of the association. Such articles of incorporation and covenants shall among other things provide:

(1) That membership shall be mandatory for each lot purchased and each successive buyer.

(2) That common open space restrictions must be permanent, not just for a period of years.

(3) That the association shall be responsible for liability, local taxes and the maintenance of recreational and other facilities.

(4) That lot owners must pay their pro rata share of the costs.

(5) That the assessment levied by the association can become a lien on the property.

(6) That the association shall be able to adjust the assessment to meet changed needs.

(7) That in the event the lot owners' association does not maintain the common open space and improvements as proposed and indicated at the time of subdivision, the county may at its option, do or contract to have done the required maintenance and recover the costs incident there to by means of a lien against the involved properties of the lot owners' association members.

(Ord. of 1956, § 22B-8; Ord. No. 10-65; Ord. No. 8-72; Ord. No. 2000-18; Ord. No. 2001-34; Ord. No. 8-2006; Ord. No. 2009-15)

Sec. 108-3-9. Procedure.

A preliminary plan of the cluster subdivision showing the areas within the subdivision to be permanently reserved for recreation and/or open space, and plans showing the proposed use, improvements and method of maintenance of such areas shall be approved by the planning commission and county commission before the cluster subdivision proposal becomes a permitted use in the zone in which it is proposed.

(Ord. of 1956, § 22B-9; Ord. No. 10-65; Ord. No. 8-72; Ord. No. 2000-18; Ord. No. 2001-34; Ord. No. 8-2006; Ord. No. 2009-15)