

Stormwater Pollution Prevention Plan

for:

The Ridge at Wolf Creek
3500 N. Moose Hollow Drive, Eden
Weber County, Utah

Operator(s):

Lewis Homes, Inc.
John Lewis
5577 E. Elkhorn Dr.
Eden, UT 84310
(801) 430-1507
john@destinationeden.com

SWPPP Contact(s):

Lewis Homes, Inc.
John Lewis
5577 E. Elkhorn Dr.
Eden, UT 84310
(801) 430-1507
john@destinationeden.com

SWPPP Preparation Date:

11/4/2013

Estimated Project Dates:

Project Start Date: 11/4/2013
Project Completion Date: 11/4/2015

Contents

SECTION 1: SITE EVALUATION, ASSESSMENT, AND PLANNING CERTIFICATION, AND SIGNATURE	1
1.1 Project/Site Information.....	1
1.2 Contact Information/Responsible Parties	2
1.3 Nature and Sequence of Construction Activity	3
1.4 Soils, Slopes, Vegetation, and Current Drainage Patterns.....	3
1.5 Construction Site Estimates	3
1.6 Receiving Waters.....	4
1.7 Site Features and Sensitive Areas to be Protected.....	4
1.8 Potential Sources of Pollution.....	4
1.9 Endangered Species Certification	5
1.10 Historic Preservation.....	6
1.11 Applicable Federal, Tribal, State or Local Programs	6
1.12 Maps.....	6
SECTION 2: EROSION AND SEDIMENT CONTROL BMPS.....	7
2.1 Minimize Disturbed Area and Protect Natural Features and Soil.....	7
2.2 Phase Construction Activity	7
2.3 Control Stormwater Flowing onto and through the Project.....	7
2.4 Stabilize Soils.....	8
2.5 Protect Slopes.....	8
2.6 Protect Storm Drain Inlets	9
2.7 Establish Perimeter Controls and Sediment Barriers.....	9
2.8 Retain Sediment On-Site.....	10
2.9 Establish Stabilized Construction Exits.....	10
SECTION 3: GOOD HOUSEKEEPING BMPS	11
3.1 Material Handling and Waste Management	11
3.2 Establish Proper Building Material Staging Areas	11
3.3 Designate Washout Areas.....	12
3.4 Establish Proper Equipment/Vehicle Fueling and Maintenance Practices	12
3.5 Control Equipment/Vehicle Washing.....	12
3.6 Spill Prevention and Control Plan.....	13
3.8 Allowable Non-Stormwater Discharge Management.....	13
SECTION 4: SELECTING POST-CONSTRUCTION BMPs	14
SECTION 5: INSPECTIONS	15
5.1 Inspections	15
5.2 Delegation of Authority	16
5.3 Corrective Action Log	16
SECTION 6: RECORDKEEPING AND TRAINING	17
6.1 Recordkeeping	17
6.2 Log of Changes to the SWPPP	17
6.3 Training.....	17
SECTION 7: FINAL STABILIZATION.....	18
SECTION 8: CERTIFICATION AND NOTIFICATION.....	19
SWPPP APPENDICES	20
Appendix A – General Location Map	

- Appendix B – Site Maps
- Appendix C – Construction General Permit
- Appendix D – NOI and Acknowledgement Letter from EPA/State
- Appendix E – Inspection Reports
- Appendix F – Corrective Action Log (or in Part 5.3)
- Appendix G – SWPPP Amendment Log (or in Part 6.2)
- Appendix H – Subcontractor Certifications/Agreements
- Appendix I – Grading and Stabilization Activities Log (or in Part 6.1)
- Appendix J – Training Log
- Appendix K – Delegation of Authority
- Appendix M – BMP Specifications

SECTION 1: SITE EVALUATION, ASSESSMENT, AND PLANNING CERTIFICATION, AND SIGNATURE

1.1 Project/Site Information

Project/Site Name: The Ridge at Wolf Creek

Project Street/Location: 3500 N. Moose Hollow Drive, Eden

City: Eden State: Utah ZIP Code: 84310

County or Similar Subdivision: Weber County

Latitude/Longitude (Use **one** of three possible formats, and specify method)

Latitude:

Longitude:

1. " N (degrees, minutes, seconds)

1. " W (degrees, minutes, seconds)

2. ' N (degrees, minutes, decimal)

2. ' W (degrees, minutes, decimal)

3. 41.192035°N (decimal)

3. 111.493050°W (decimal)

Method for determining latitude/longitude:

USGS topographic map (specify scale: _____)

EPA Web site GPS

Other (please specify): Google Earth

Is the project located in Indian country? Yes No

If yes, name of Reservation, or if not part of a Reservation, indicate "not applicable." _____

Is this project considered a federal facility? Yes No

UPDES project or permit tracking number*: UTR365661

**(This is the unique identifying number assigned to your project by your permitting authority after you have applied for coverage under the appropriate National Pollutant Discharge Elimination System (UPDES) construction general permit.)*

1.2 Contact Information/Responsible Parties

Operator(s):

Lewis Homes, Inc.
John Lewis
5577 E. Elkhorn Dr.
Eden, UT 84310
(801) 430-1507
john@destinationeden.com

Project Manager(s) or Site Supervisor(s):

Lewis Homes, Inc.
John Lewis
5577 E. Elkhorn Dr.
Eden, UT 84310
(801) 430-1507

SWPPP Contact(s):

Lewis Homes, Inc.
John Lewis
5577 E. Elkhorn Dr.
Eden, UT 84310
(801) 430-1507

This SWPPP was Prepared by:

Gardner Engineering:
Ryan Christensen
5150 S 375 E
Ogden, Utah 8445
(801) 476-0202
ryan@gardnerengineering.net

Subcontractor(s):

Emergency 24-Hour Contact:

Lewis Homes, Inc.
John Lewis
5577 E. Elkhorn Dr.
Eden, UT 84310
(801) 430-1507

1.3 Nature and Sequence of Construction Activity

Describe the general scope of the work for the project, major phases of construction, etc:

Residential construction in The Ridge at Wolf Creek. The scope of work will include the construction and installation of buildings, roadways and utilities.

What is the function of the construction activity?

Residential Commercial Industrial Road Construction Linear Utility
 Other (please specify):

Estimated Project Start Date: 11/4/2013

Estimated Project Completion Date: 11/4/2015

1.4 Soils, Slopes, Vegetation, and Current Drainage Patterns

Soil type(s):

NRCS web soil site lists the soil to be Yeates Hollow very stony loam, 10 to 30 percent slopes.

Slopes (describe current slopes and note any changes due to grading or fill activities):

The existing slopes are 10 to 30 percent. Site grading will be required for building and roadway construction.

Drainage Patterns:

Storm water will be conveyed through the storm drain system.

Vegetation: There are currently native grasses throughout the site; the proposed landscape will include sod and various bushes & trees. Disturbed areas may also be reseeded with native grasses.

Other:

1.5 Construction Site Estimates

The following are estimates of the construction site.

Total project area:	16.4 acres
Construction site area to be disturbed:	8-10 acres
Percentage impervious area before construction:	0.0%

Runoff coefficient before construction:	0.10
Runoff coefficient after construction	0.30
Description of unique features that are to be preserved:	None applicable
Describe measures to protect these features:	Not applicable
Percentage impervious area after construction:	30%

1.6 Receiving Waters

Description of receiving waters: Pineview Reservoir in the Ogden River watershed

Description of storm sewer systems: Storm water will be collected and routed to a detention pond. From there, the storm water makes its way towards Pineview Reservoir via drainage on the east side of the project.

Description of impaired waters or waters subject to TMDLs: Pineview Reservoir has an impaired status associated with Temperature as of 2006, according to the EPA.
(http://ofmpub.epa.gov/tmdl_waters10/attains_waterbody.control?p_au_id=UT-L-16020102-014_00&p_cycle=2006&p_state=UT&p_report_type=) The storm water from the project location is unlikely to affect the reservoir for two reasons: heat is not being transferred to the water by an industrial or commercial practice; the storm water volume is small, comparatively.

Other:

1.7 Site Features and Sensitive Areas to be Protected

NONE

1.8 Potential Sources of Pollution

Potential sources of sediment to stormwater runoff:

Runoff during construction from material stockpiles and disturbed and stripped soils

Potential pollutants and sources, other than sediment, to stormwater runoff:

Oils and fuels from construction equipment

Trade Name Material	Stormwater Pollutants	Location

1.9 Endangered Species Certification

Are endangered or threatened species and critical habitats on or near the project area?

Yes No

Describe how this determination was made:

<http://www.fws.gov/endangered/index.html>, visual inspection

If yes, describe the species and/or critical habitat:

If yes, describe or refer to documentation that determines the likelihood of an impact on identified species and/or habitat and the steps taken to address that impact. (Note, if species are on or near your project site, EPA strongly recommends that the site operator work closely with the appropriate field office of the U.S. Fish and Wildlife Service or National Marine Fisheries Service. For concerns related to state or tribal listing of species, please contact a state or tribal official.)

1.10 Historic Preservation

Are there any historic sites on or near the construction site?

Yes No

Describe how this determination was made:

<http://www.nationalregisterofhistoricplaces.com/ut/Weber/state.html> , no visual evidence

If yes, describe or refer to documentation that determines the likelihood of an impact on this historic site and the steps taken to address that impact.

1.11 Applicable Federal, Tribal, State or Local Programs

NA

1.12 Maps

See Appendix A and B.

SECTION 2: EROSION AND SEDIMENT CONTROL BMPS

2.1 *Minimize Disturbed Area and Protect Natural Features and Soil*

2.2 *Phase Construction Activity*

The Project will be developed in 5 Phases. Each Phase will include the following Construction Phases:

- Phase I
 - Construction Phase – Clearing & Grubbing, Finish Grading, Installation of appurtenant improvements
 - 1-6 month duration
 - Silt fence, Inlet protection, minimize disturbance

- Phase II
 - Post Construction Phase
 - 1-6 month duration
 - Re-establish vegetation. Sod and Grade area.

2.3 *Control Stormwater Flowing onto and through the Project*

<i>BMP Description:</i> Storm Drain Collection System	
<i>Installation Schedule:</i>	Installed prior to construction
<i>Maintenance and Inspection:</i>	Weekly
<i>Responsible Staff:</i>	Lewis Homes, Inc.
<i>BMP Description:</i>	
<i>Installation Schedule:</i>	
<i>Maintenance and Inspection:</i>	
<i>Responsible Staff:</i>	

2.4 Stabilize Soils

BMP Description: Dust Control

<input type="checkbox"/> <i>Permanent</i> <input checked="" type="checkbox"/> <i>Temporary</i>	
<i>Installation Schedule:</i>	Throughout Construction
<i>Maintenance and Inspection:</i>	As Necessary
<i>Responsible Staff:</i>	Lewis Homes, Inc.

BMP Description:

<input type="checkbox"/> <i>Permanent</i> <input type="checkbox"/> <i>Temporary</i>	
<i>Installation Schedule:</i>	
<i>Maintenance and Inspection:</i>	
<i>Responsible Staff:</i>	

2.5 Protect Slopes

BMP Description: Silt Fence

<i>Installation Schedule:</i>	Before Construction
<i>Maintenance and Inspection:</i>	Weekly
<i>Responsible Staff:</i>	Lewis Homes, Inc.

BMP Description:

<i>Installation Schedule:</i>	
<i>Maintenance and Inspection:</i>	
<i>Responsible Staff:</i>	

2.6 **Protect Storm Drain Inlets**

BMP Description: Rock filled bags at inlet of pipe ends

<i>Installation Schedule:</i>	Before construction begins
<i>Maintenance and Inspection:</i>	Weekly
<i>Responsible Staff:</i>	Lewis Homes, Inc.

BMP Description: Silt Fence

<i>Installation Schedule:</i>	Before Construction begins
<i>Maintenance and Inspection:</i>	Weekly
<i>Responsible Staff:</i>	Lewis Homes, Inc.

BMP Description: Tracking Pad

<i>Installation Schedule:</i>	Before Construction begins
<i>Maintenance and Inspection:</i>	Weekly
<i>Responsible Staff:</i>	Lewis Homes, Inc.

BMP Description: Concrete Washout

<i>Installation Schedule:</i>	Before Installation of concrete
<i>Maintenance and Inspection:</i>	Weekly
<i>Responsible Staff:</i>	Lewis Homes, Inc.

2.7 **Establish Perimeter Controls and Sediment Barriers**

BMP Description: Silt Fence

<i>Installation Schedule:</i>	Prior to beginning construction
<i>Maintenance and Inspection:</i>	Weekly
<i>Responsible Staff:</i>	Lewis Homes, Inc.

2.8 Retain Sediment On-Site

BMP Description: Check Dam

<i>Installation Schedule:</i>	Once Construction Begins
<i>Maintenance and Inspection:</i>	Weekly
<i>Responsible Staff:</i>	Lewis Homes, Inc.

2.9 Establish Stabilized Construction Exits

BMP Description: Tracking Pad

<i>Installation Schedule:</i>	Prior to construction
<i>Maintenance and Inspection:</i>	Weekly
<i>Responsible Staff:</i>	Lewis Homes, Inc.

SECTION 3: GOOD HOUSEKEEPING BMPS

3.1 Material Handling and Waste Management

<i>BMP Description: Remove and Dispose of garbage and construction waste</i>	
<i>Installation Schedule:</i>	Once construction begins
<i>Maintenance and Inspection:</i>	Weekly
<i>Responsible Staff:</i>	Lewis Homes, Inc.
<i>BMP Description:</i>	
<i>Installation Schedule:</i>	
<i>Maintenance and Inspection:</i>	
<i>Responsible Staff:</i>	

3.2 Establish Proper Building Material Staging Areas

<i>BMP Description Establish & Utilize Staging Area</i>	
<i>Installation Schedule:</i>	Before Construction
<i>Maintenance and Inspection:</i>	Weekly
<i>Responsible Staff:</i>	
<i>BMP Description:</i>	
<i>Installation Schedule:</i>	
<i>Maintenance and Inspection:</i>	
<i>Responsible Staff:</i>	

3.3 Designate Washout Areas

BMP Description: Concrete Washout

<i>Installation Schedule:</i>	Prior to pouring of concrete
<i>Maintenance and Inspection:</i>	Weekly
<i>Responsible Staff:</i>	Lewis Homes, Inc.

3.4 Establish Proper Equipment/Vehicle Fueling and Maintenance Practices

BMP Description: Spill Kits

<i>Installation Schedule:</i>	Have them available if a spill should occur
<i>Maintenance and Inspection:</i>	Weekly
<i>Responsible Staff:</i>	Lewis Homes, Inc.

BMP Description: Fuel and maintain in areas away from inlets

<i>Installation Schedule:</i>	Beginning of project
<i>Maintenance and Inspection:</i>	Weekly
<i>Responsible Staff:</i>	Lewis Homes, Inc.

3.5 Control Equipment/Vehicle Washing

BMP Description: NO Washing of construction Vehicles allowed.

<i>Installation Schedule:</i>	
<i>Maintenance and Inspection:</i>	
<i>Responsible Staff:</i>	

3.6 Spill Prevention and Control Plan

<i>BMP Description: Spill Kits</i>	
<i>Installation Schedule:</i>	Have them available if a spill should occur
<i>Maintenance and Inspection:</i>	Weekly
<i>Responsible Staff:</i>	Lewis Homes, Inc.

<i>BMP Description: Fuel and maintain in areas away from inlets</i>	
<i>Installation Schedule:</i>	Beginning of project
<i>Maintenance and Inspection:</i>	Weekly
<i>Responsible Staff:</i>	Lewis Homes, Inc.

3.8 Allowable Non-Stormwater Discharge Management

List allowable non-stormwater discharges and the measures used to eliminate or reduce them and to prevent them from becoming contaminated:

<i>BMP Description: Dust Control</i>	
<i>Installation Schedule:</i>	
<i>Maintenance and Inspection:</i>	
<i>Responsible Staff:</i>	

<i>BMP Description: Line Flushing Water</i>	
<i>Installation Schedule:</i>	
<i>Maintenance and Inspection:</i>	
<i>Responsible Staff:</i>	

SECTION 4: SELECTING POST-CONSTRUCTION BMPs

BMP Description: Sod or seed per landscape plans

<i>Installation Schedule:</i>	Upon completion of each phase construction
<i>Maintenance and Inspection:</i>	As needed to establish growth
<i>Responsible Staff:</i>	Lewis Homes, Inc.

BMP Description: Planting (Trees and Shrubs)

<i>Installation Schedule:</i>	Upon completion of each phase construction
<i>Maintenance and Inspection:</i>	As needed to establish growth
<i>Responsible Staff:</i>	Lewis Homes, Inc.

SECTION 5: INSPECTIONS

5.1 *Inspections*

1. ***Inspection Personnel:*** Identify the person(s) who will be responsible for conducting inspections and describe their qualifications:

John Lewis – Contracting experience

2. ***Inspection Schedule and Procedures:***

Describe the inspection schedules and procedures you have developed for your site (include frequency of inspections for each BMP or group of BMPs, indicate when you will inspect, e.g., before/during/and after rain events, spot inspections):

Weekly- once every 7 days

Describe the general procedures for correcting problems when they are identified. Include responsible staff and time frames for making corrections:

Make modifications/repairs as they arise – Lewis Homes will ensure corrections
Inspection form is included in the appendix.

5.2 Delegation of Authority

Duly Authorized Representative(s) or Position(s):

5.3 Corrective Action Log

Corrective Action Log: See Appendix

SECTION 6: RECORDKEEPING AND TRAINING

6.1 *Recordkeeping*

Records will be retained for a minimum period of at least 2 years after the permit is terminated.

---UPDATE DATES THROUGHOUT PROJECT---

Date(s) when major grading activities occur:

Date(s) when construction activities temporarily or permanently cease on a portion of the site:

Date(s) when an area is either temporarily or permanently stabilized:

6.2 *Log of Changes to the SWPPP*

Log of changes and updates to the SWPPP – See Appendix

6.3 *Training*

Individual(s) Responsible for Training:

[John Lewis](#)

Describe Training:

- General stormwater and BMP awareness training for staff and subcontractors:
- Detailed training for staff and subcontractors with specific stormwater responsibilities:

SECTION 7: FINAL STABILIZATION

BMP Description: Landscaping – Install Sod and Misc. Vegetation

<i>Installation Schedule:</i>	Upon completion of construction
<i>Maintenance and Inspection:</i>	As needed to establish growth
<i>Responsible Staff:</i>	Lewis Homes, Inc.

BMP Description:

<i>Installation Schedule:</i>	
<i>Maintenance and Inspection:</i>	
<i>Responsible Staff:</i>	

SECTION 8: CERTIFICATION AND NOTIFICATION

I certify under penalty of law that this document and all attachments were prepared under my direction or supervision in accordance with a system designed to assure that qualified personnel properly gathered and evaluated the information submitted. Based on my inquiry of the person or persons who manage the system, or those persons directly responsible for gathering the information, the information submitted is, to the best of my knowledge and belief, true, accurate, and complete. I am aware that there are significant penalties for submitting false information, including the possibility of fine and imprisonment for knowing violations.

Name: _____ Title: _____

Signature: _____ Date: _____

SWPPP APPENDICES

Attach the following documentation to the SWPPP:

Appendix A – General Location Map

Appendix B – Site Maps

Appendix C – Construction General Permit

***Appendix D – NOI and Acknowledgement Letter from
EPA/State/MS4***

Appendix E – Inspection Reports

Appendix F – Corrective Action Log (or in Part 5.3)

Appendix G – SWPPP Amendment Log (or in Part 6.2)

Appendix H – Subcontractor Certifications/Agreements

***Appendix I – Grading and Stabilization Activities Log (or in Part
6.1)***

Appendix J – Training Log

Appendix K – Delegation of Authority

Appendix M – BMP Specifications

Appendix A – General Location Map



Appendix B – Site Maps



REVISIONS	DESCRIPTION
DATE	

SCALE	#####
DATE	OCTOBER 2013
DESIGN	RC
DRAWN	DJB
CHECKED	TN

DWG: 13.1201.1300.DESIGN PROJ. DWG SITE - THE RIDGE, LEWIS HOMES.DWG

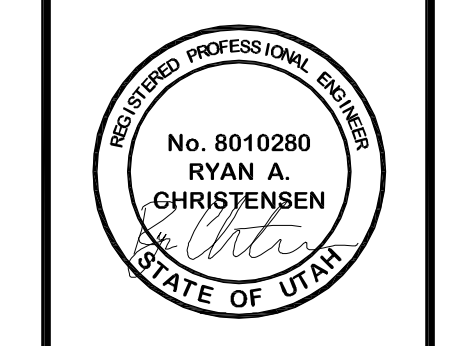

STORM WATER POLLUTION PREVENTION PLAN
THE RIDGE
LEWIS HOMES
EDEN, WEBER COUNTY, UTAH

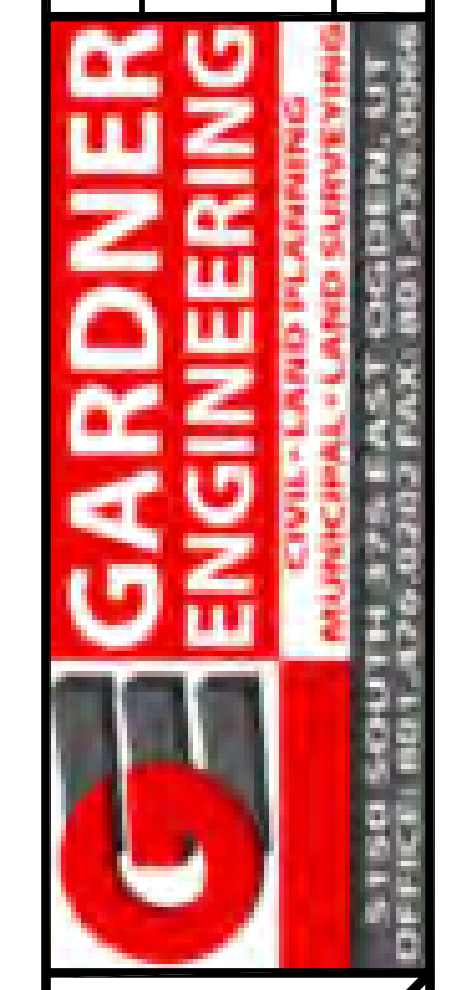

3
 3

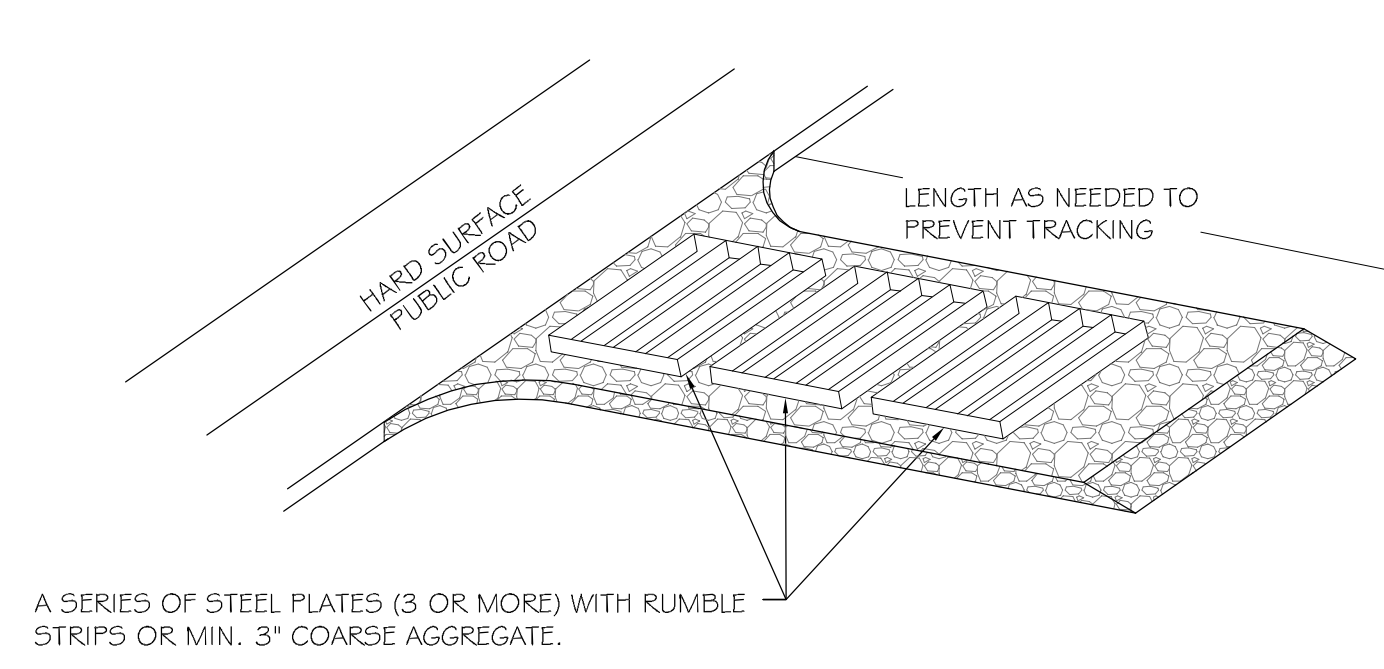

- ENTRANCE STABILIZATION NOTES:**
- SEDIMENTS AND OTHER MATERIALS SHALL NOT BE TRACKED FROM THE SITE BY VEHICLE TRAFFIC. THE CONSTRUCTION ENTRANCE ROADWAYS SHALL BE STABILIZED SO AS TO PREVENT SEDIMENTS FROM BEING DEPOSITED INTO THE STORM DRAIN SYSTEMS. DEPOSITIONS MUST BE SWEEPED UP IMMEDIATELY AND MAY NOT BE WASHED DOWN BY RAIN OR OTHER MEANS INTO THE STORM DRAIN SYSTEM.
 - STABILIZED CONSTRUCTION ENTRANCE SHALL BE:
 - LOCATED AT ANY POINT WHERE TRAFFIC WILL BE ENTERING OR LEAVING A CONSTRUCTION SITE TO OR FROM A PUBLIC RIGHT-OF-WAY, STREET, ALLEY AND SIDEWALK OR PARKING AREA.
 - A SERIES OF STEEL PLATES WITH "RUMBLE STRIPS", AND/OR MIN. 3" COARSE AGGREGATE WITH LENGTH, WIDTH AND THICKNESS AS NEEDED TO ADEQUATELY PREVENT ANY TRACKING ONTO PAVED SURFACES.
 - ADDING A WASH RACK WITH A SEDIMENT TRAP LARGE ENOUGH TO COLLECT ALL WASH WATER CAN GREATLY IMPROVE EFFICIENCY.
 - ALL VEHICLES ACCESSING THE CONSTRUCTION SITE SHALL UTILIZE THE STABILIZED CONSTRUCTION ENTRANCE SITES.
- STREET MAINTENANCE NOTES:**
- REMOVE ALL SEDIMENT DEPOSITED ON PAVED ROADWAYS IMMEDIATELY.
 - SWEEP PAVED AREAS THAT RECEIVE CONSTRUCTION TRAFFIC WHENEVER SEDIMENT BECOMES VISIBLE.
 - PAVEMENT WASHING WITH WATER IS PROHIBITED IF IT RESULTS IN A DISCHARGE TO THE STORM DRAIN SYSTEM.

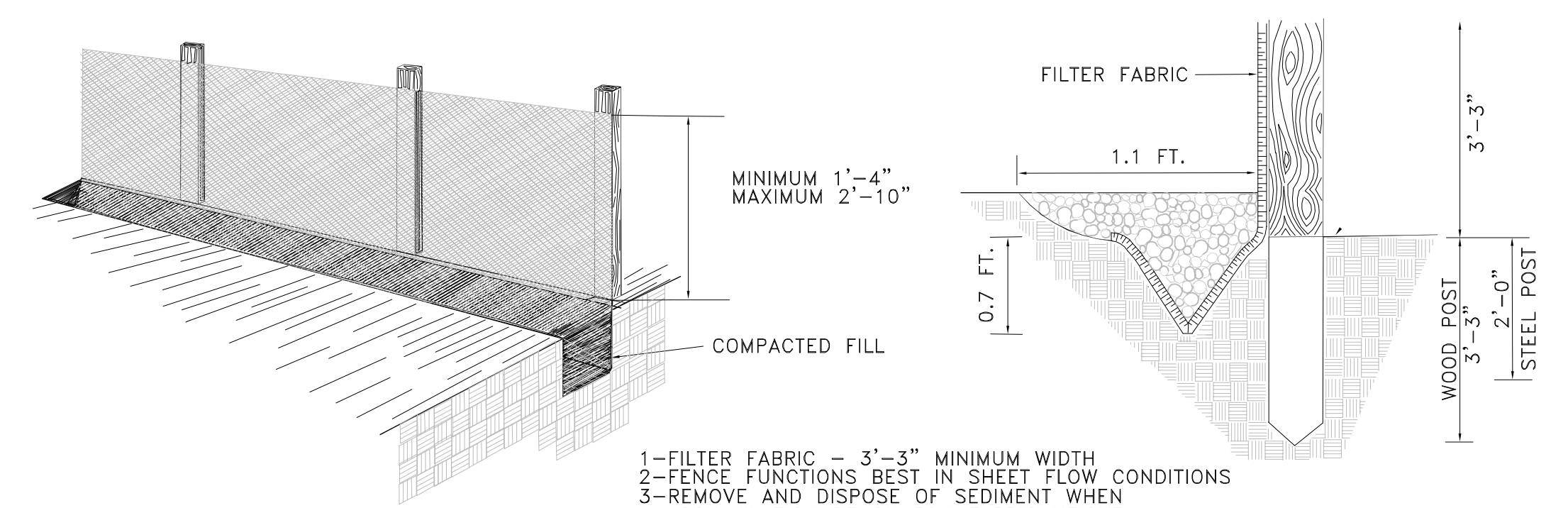

- FILTER FABRIC - 3'-3" MINIMUM WIDTH
- FENCE FUNCTIONS BEST IN SHEET FLOW CONDITIONS
- REMOVE AND DISPOSE OF SEDIMENT WHEN ACCUMULATION REACH 50% FABRIC HEIGHT.
- BACKFILL MIN 0.7 FT. THICK LAYER OF FREE DRAINING GRANULAR BACKFILL MATERIAL.

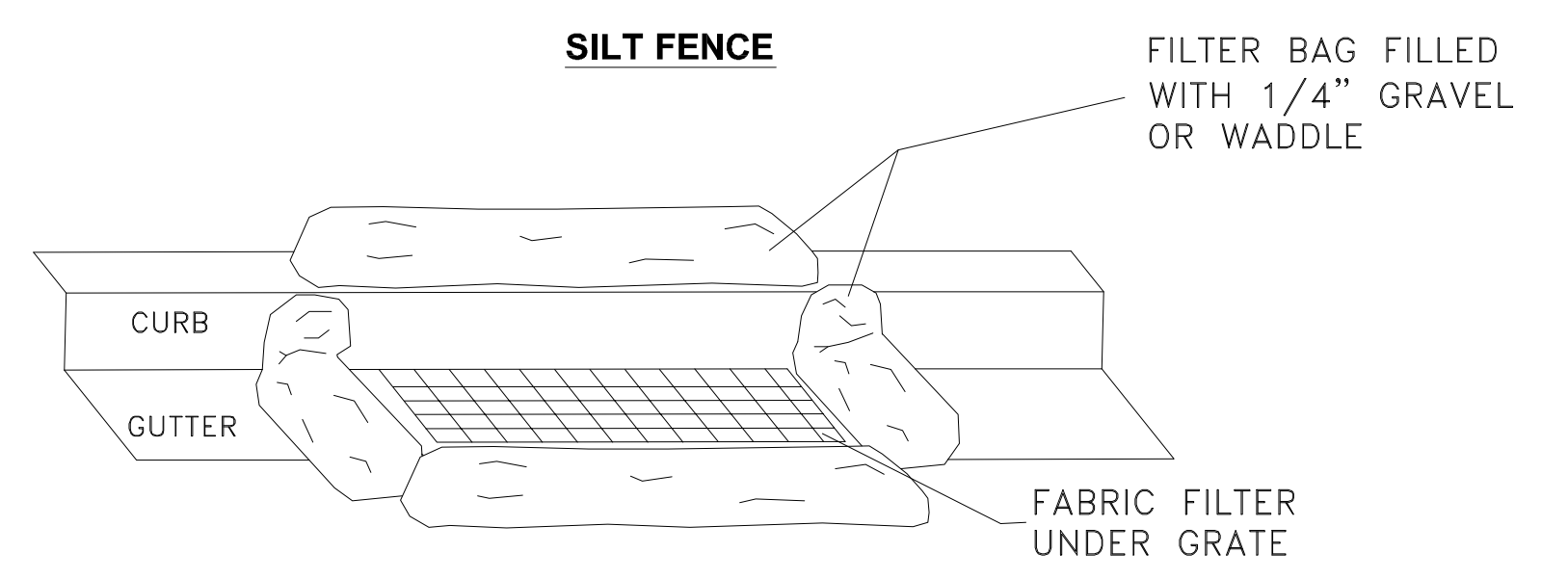

INLET PROTECTION

LEGEND

- INLET PROTECTION (GRAVEL FILLED WATTLES AND FABRIC UNDER GRATE)
- SILT FENCE - INSTALL SILT FENCE AS NEEDED TO CONTROL SEDIMENT
- FIBER ROLL / GRAVEL FILLED WATTLES (INSTALLED IN DRAINAGE SWALE)

SWPPP KEY NOTES

- STABILIZED CONSTRUCTION ENTRANCE
- WASH-OUT AREA
- POSTED SWPPP LOCATION

SWPPP NOTES

- CONTRACTOR SHALL OBTAIN NECESSARY PERMITS FROM THE COUNTY AND THE STATE AS REQUIRED.
- ALL REQUIREMENTS OF THE GENERAL PERMIT FOR CONSTRUCTION ACTIVITIES SHALL BE MET.
- ALL BMP'S SHALL BE IN PLACE PRIOR TO BEGINNING OF CONSTRUCTION OR ACTIVITIES THAT MAY REQUIRE BMP'S
- AN UPDATED COPY OF THE SWPPP SHALL BE MAINTAINED AT THE SITE.
- SILT FENCE, INLET PROTECTION, AND STREET CLEANING SHALL BE COMPLETED AS NEEDED TO PREVENT EROSION AND SEDIMENT FROM LEAVING THE SITE.

DEVELOPER:
LEWIS HOMES
ERIC HOUSEHOLDER
801-389-0040

Appendix C – Construction General Permit

**STATE OF UTAH DEPARTMENT OF ENVIRONMENTAL QUALITY
DIVISION OF WATER QUALITY**

**Authorization to Discharge Under the
Utah Pollutant Discharge Elimination System**

**Storm Water General Permit for
Construction Activities
Permit No. UTR300000**

This Permit is issued in compliance with the provisions of the Utah Water Quality Act, Title 19, Chapter 5, Utah Code Annotated 2004, as amended (the "Act") and the federal Water Pollution Control Act (33 U.S.C. §§ 1251 *et. seq.*, as amended to date), and the rules and Regulations made pursuant to those statutes.

This Permit authorizes storm water discharges to waters of the State of Utah resulting from construction activities, including construction support activities, anywhere within the State of Utah as provided in Parts 1.4 and 1.5 of this Permit. This authorization is conditioned upon a discharger meeting the eligibility requirements in Part 1.2.2 of this Permit, including preparation of a Storm Water Pollution Prevention Plan prior to filing a Notice of Intent ("NOI") to discharge under this General Permit. A discharger is not covered by this Permit if the discharger submits an NOI but has not met these conditions.

This authorization is subject to the authority of the Utah Water Quality Board or the Executive Secretary of the Utah Water Quality Board to reopen this Permit (*see* Part 5.15 of this Permit), or to require a discharger to obtain an individual permit or use an alternative general permit (*see* Part 2.3 of this Permit). The issuance of a discharge permit authorization under this general Permit does not relieve Permittees of other duties and responsibilities under the Act or rules made under that Act. Significant terms used in this Permit are defined in Part 6 of this Permit.

This Permit shall become effective on July 1, 2008.

This Permit and the authorization to discharge shall expire at midnight, June 30, 2013, except as described in Part 2.4 of this Permit.

Signed this 26th day of June, 2008.

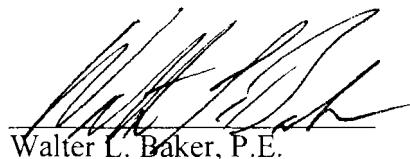

Walter L. Baker, P.E.
Executive Secretary,
Utah Water Quality Board

TABLE OF CONTENTS

PART 1: PERMIT SCOPE AND COVERAGE	3
1.1 Persons Required to Obtain Authorization for Discharge.	3
1.2 Permit Area and Eligibility.	3
1.3 Authorization to Discharge.	3
1.4 Allowable Storm Water Discharges.	3
1.5 Allowable Non-storm Water Discharges.	4
1.6 Discharges Not allowed Under This Permit.	4
1.7 Authorization to Discharge Date.	5
1.8 Notice of Intent	5
1.9 Coverage Before October 1, 2008.	5
1.10 Late Notifications.	6
PART 2. SPECIAL CONDITIONS, MANAGEMENT PRACTICES, RESPONSIBILITIES, AND OTHER NON-NUMERIC LIMITATIONS	7
2.1 Releases in Excess of Reportable Quantities.	7
2.2 Discharge Compliance with Water Quality Standards and TMDL Requirements.	7
2.3 Requiring an Individual Permit or an Alternative General Permit.	8
2.4 Continuation of the Expired General Permit.	9
PART 3. STORM WATER POLLUTION PREVENTION PLANS	10
3.1 SWPPP Required.	10
3.2 SWPPP Location, Availability, Revision, and Signature.	10
3.3 Keeping SWPPPs Current.	11
3.4 More Than One Permittee.	11
3.5 Contents of SWPPP.	12
PART 4. TERMINATION/CHANGES IN OWNER/OPERATOR FOR SITE	19
4.1 Termination of Coverage	19
4.2 Conditions for Submitting an NOT.	19
4.3 Updating the SWPPP	
PART 5. STANDARD PERMIT CONDITIONS	20
5.1 Duty to Comply.	20
5.2 Duty to Reapply.	20
5.3 Need to Halt or Reduce Activity Not a Defense.	20
5.4 Duty to Mitigate.	20
5.5 Duty to Provide Information.	20
5.6 Other Information.	20
5.7 Oil and Hazardous Substance Liability.	21
5.8 Property Rights.	21
5.9 Severability	21
5.10 Record Retention.	21
5.11 Addresses.	21
5.12 State Laws.	21
5.13 Proper Operation and Maintenance.	21
5.14 Inspection and Entry	22
5.15 Reopener Clause.	22
5.16 Signatory Requirements.	22
PART 6. DEFINITIONS	24

PART 1: PERMIT SCOPE AND COVERAGE

- 1.1 Persons required to obtain authorization for discharge. No person may conduct construction activities that disturb an area greater than or equal to one acre without authorization for storm water discharge from the Executive Secretary. (See Utah Admin. Code Sections R317-8-3.9(6)(d)(10) and R317-8-3.9(6)(e)(1).) In addition, no person may conduct construction activities that disturb an area smaller than one acre if the disturbance is part of a larger common plan of development or sale that will ultimately disturb an area greater than or equal to one acre. *Id.* See Part 6.5 of this Permit for a definition of “construction activities.”
- 1.2 Permit Area and Eligibility.
 - 1.2.1. Construction activities located within the State of Utah, except for Indian Country (see Part 6.16 of this Permit for a definition of “Indian Country”) may be eligible to be covered under this Permit.
 - 1.2.2. Eligibility for authorization to discharge under this Permit is conditioned upon:
 - a. Preparation of a Storm Water Pollution Prevention Plan (“SWPPP”) (see Part 3 of this permit) prior to submission of a Notice of Intent (“NOI”);
 - b. Submission of a complete and accurate Notice of Intent to be covered by this Permit (see Part 1.8 of this Permit); and
 - c. Payment of applicable fees.
- 1.3 Authorization to Discharge. This Permit authorizes discharges of storm water from construction activities that disturb an area greater than or equal to one acre, and from construction activities that disturb an area smaller than one acre if the disturbance is part of a larger common plan of development or sale that will ultimately disturb an area greater than or equal to one acre. This authorization is subject to all of the terms and conditions of this Permit, including the requirement that the discharger must submit a Notice of Intent (“NOI”), and the prohibitions on discharges specified in Part 1.6.
- 1.4 Allowable Storm Water Discharges. Subject to compliance with the terms and conditions of this Permit, a Permittee is authorized to discharge pollutants in:
 - 1.4.1. Storm water associated with construction activity as that term is defined in Part 6.5 of this Permit (but see Part 1.4.3 of this Permit for limitations on discharges from construction support activities);
 - 1.4.2. Storm water discharges designated by the Executive Secretary as needing a storm water permit under R317-8-3.9(6)(e)(2);
 - 1.4.3. Discharges from construction support activities as that term is defined in Part 6.6 of this Permit, provided:
 - a. The support activity is directly related to the construction site required to have UPDES permit coverage for discharges of storm water associated with construction activity;
 - b. The support activity is not a commercial operation serving multiple unrelated construction projects by different owners/operators, and does not operate beyond the completion of the construction activity at the last construction project it supports; and
 - c. Appropriate controls and measures are identified in a Storm Water Pollution

- Prevention Plan (SWPPP) covering the discharges from the support activity areas; and
- 1.4.4. Discharges composed of allowable discharges listed in Part 1.4 and 1.5 of this Permit commingled with a discharge authorized by a different UPDES permit and/or a discharge that does not require UPDES permit authorization.
- 1.5. Allowable Non-storm Water Discharges. A Permittee is authorized to make the following non-storm water discharges, provided the non-storm water component of the discharge is in compliance with Part 3.5.5 of this Permit:
- 1.5.1. Discharges from fire-fighting activities;
 - 1.5.2. Fire hydrant flushings;
 - 1.5.3. Waters used to wash vehicles where detergents are not used;
 - 1.5.4. Water used to control dust in accordance with Part 3.5.2(c)(2);
 - 1.5.5. Potable water including uncontaminated water line flushings;
 - 1.5.6. Routine external building wash down that does not use detergents;
 - 1.5.7. Pavement wash waters where spills or leaks of toxic or hazardous materials have not occurred (unless all spilled material has been removed) and where detergents are not used;
 - 1.5.8. Uncontaminated air conditioning or compressor condensate;
 - 1.5.9. Uncontaminated ground water or spring water;
 - 1.5.10. Foundation or footing drains where flows are not contaminated with process materials such as solvents;
 - 1.5.11. Landscape and other irrigation drainage.
- 1.6. Discharges not allowed under this Permit. Notwithstanding any other language in this Permit, the following storm water discharges are not authorized by this Permit:
- 1.6.1. Discharges from Construction Activities within Indian Country. This Permit does not cover discharges within Indian Country as that term is defined in Part 6.16 of this Permit;¹
 - 1.6.2. Post Construction Discharges. Storm water discharges that originate from the site after construction activities have been completed and the site has undergone final stabilization;
 - 1.6.3. Discharges Mixed with Non-storm Water. Discharges that are mixed with sources of non-storm water other than discharges which are identified in Part 1.5 of this Permit and in compliance with Part 3.5.5 (non-storm water discharges) of this Permit;
 - 1.6.4. Discharges Covered by Another Permit. Storm water discharges associated with construction activity for which an individual permit has been issued, or for which the owner/operator is required to or may obtain coverage under an individual permit or an alternative general permit (*see* Part 2.3 of this Permit), including a general

¹ The State of Utah, *Division of Water Quality*, does not have permit authority for Indian Country. Storm water permits for Indian Country within the State must be acquired through EPA Region VIII, except for facilities on the Navajo Reservation or on the Goshute Reservation which must acquire storm water permits through EPA Region IX.

permit issued for areas regulated by a qualified municipal Separate Storm Sewer System Program;

- 1.6.5. Discharges Threatening Water Quality. Storm water discharges from construction activities that cause or have the reasonable potential to cause a violation of a water quality standard. *See* Part 2.2 of this Permit;
 - 1.6.6. Discharges from commercial construction support and related activities. Storm water discharges from construction support activities unless they are included within the definition in Part 6.6 of this permit;
 - 1.6.7. Spills. This Permit does not authorize the discharge of hazardous substances or oil resulting from an on-site spill; and
 - 1.6.8. Discharges that result from violations of this Permit.
- 1.7 Authorization to Discharge Date.
- 1.7.1. This permit is effective as of July 1, 2008 and is effective for five years, expiring at 11:59 p.m. on June 30, 2013.
 - 1.7.2. Unless notified by the Executive Secretary to the contrary, a discharger is authorized for coverage under this Permit and may begin construction activities immediately after preparing a SWPPP for the construction activities (*see* Part 1.2.2(a) of this Permit), and after submitting an NOI and permit fee (*see* Part 1.2.2(b) and (c) of this Permit). The date of submission of the NOI or a permit fee shall be the date of its receipt by the Executive Secretary, or the date the NOI or permit fee are submitted electronically using the website for the Utah Division of Water Quality. Any NOIs mailed to the Executive Secretary shall be mailed to the address specified in Part 5.11 of this Permit.
 - 1.7.3. The Executive Secretary may, with written notice (including electronic notice) delay authorization to verify an applicant's eligibility or resolve other concerns. In these instances, a discharger is not authorized for coverage under this permit until it receives notice from the Executive Secretary.
- 1.8 Notice of Intent
- 1.8.1. A person who wishes to submit an NOI must use the NOI form provided by the Executive Secretary (or a copy thereof), or submit an NOI electronically (<https://secure.utah.gov/stormwater/>).
 - 1.8.2. All questions in an NOI form provided by the Executive Secretary or answered in the course of submitting an NOI electronically must be answered completely and accurately.
 - 1.8.3. The NOI, whether on the form provided by the Executive Secretary or submitted electronically, must include a certification statement, and must be signed and dated by an authorized representative as specified in Part 5.16 of this Permit.
- 1.9 Coverage before June 30, 2010. Permittee's that previously received authorization to discharge under the October 1, 2002 General Permit (2002 General Permit) and still have active coverage shall without submission of an NOI continue coverage under UTR200000 until June 30, 2010 at which time, or before if desired, the Permittee shall, by submission of an NOI (either on-line www.waterquality.utah.gov/updes/stormwatercon.htm or by paper submission) obtain coverage under this Permit (UTR300000).

- 1.10 Late Notifications. Persons are not prohibited from submitting NOIs after initiating clearing, grading, excavation activities, or other construction activities. When a late NOI is submitted, authorization for discharges occurs consistent with Subpart 2.1. The Agency reserves the right to take enforcement action for any un-permitted discharges that occur between the commencement of construction and discharge authorization.

**PART 2. SPECIAL CONDITIONS, MANAGEMENT PRACTICES,
RESPONSIBILITIES, AND OTHER NON-NUMERIC LIMITATIONS**

- 2.1 Releases in excess of Reportable Quantities. The discharge of hazardous substances or oil in the storm water discharge(s) from a site shall be prevented or minimized in accordance with the applicable SWPPP for the site. This Permit does not relieve the Permittee of the reporting requirements of 40 CFR part 117, 40 CFR 110, and 40 CFR part 302. Where a release containing a hazardous substance in an amount equal to or in excess of a reportable quantity established under either 40 CFR 117, 40 CFR 110, or 40 CFR 302, occurs during a 24 hour period:
- 2.1.1. The Permittee is required to notify the National Response Center (NRC) (800-424-8802) in accordance with the requirements of 40 CFR 117, 40 CFR 110, and 40 CFR 302 and the Division of Water Quality (DWQ) (801-538-6146) or the 24 hour DWQ answering service at 801-536-4123 as soon as he or she has knowledge of the discharge;
 - 2.1.2. The Permittee shall submit within 14 calendar days of knowledge of the release a written description of: the release (including the type and estimate of the amount of material released), the date that such release occurred, the circumstances leading to the release, the measures taken and/or planned to be taken to cleanup the release, and steps to be taken to minimize the chance of future occurrences to the Executive Secretary; and
 - 2.1.3. The SWPPP required under Part 3 of this Permit must be modified within 14 calendar days of knowledge of the release to provide a description of the release, the circumstances leading to the release, and the date of the release. In addition, the SWPPP must be reviewed to identify measures to prevent the reoccurrence of such releases and to respond to such releases, and the SWPPP must be modified where appropriate.
- 2.2 Discharge Compliance with Water Quality Standards and TMDL requirements. Storm water discharges from construction activities that cause or have the reasonable potential to cause a violation of a water quality standard or a violation of Total Maximum Daily Load (“TMDL”) requirements are not authorized by this Permit. If there is a TMDL requirement for the receiving water, that requirement, rather than a water quality standard, will govern. If a discharge that would otherwise be covered by this Permit causes a violation or if there is a reasonable potential a discharge will cause a violation, the Permittee will take all necessary actions to ensure future discharges do not cause or contribute to the violation of a water quality standard or a TMDL requirement, and shall document these actions in the SWPPP.

If the Executive Secretary determines that construction activities have caused or have the reasonable potential to cause a violation of a water quality standard or a TMDL requirement, the discharger will be notified by the Executive Secretary of additional requirements for treatment or handling of the discharge to ensure future discharges do not cause or contribute to the violation. The Permittee will document these requirements in the SWPPP. The Executive Secretary may authorize continued coverage under this Permit after appropriate controls and implementation procedures, designed to bring the discharges

into compliance with water quality standards or TMDL requirements, have been included in the SWPPP.

Alternatively, the Executive Secretary may notify the Permittee that an individual permit application is necessary (see Part 2.3 of this Permit).

If violations remain or re-occur, then coverage under this Permit may be terminated by the Executive Secretary and an alternative permit may be issued or denied. Compliance with this requirement does not preclude any enforcement activity as provided by the Water Quality Act for the underlying violation.

2.3 Requiring an Individual Permit or an Alternative General Permit.

- 2.3.1. The Executive Secretary may require any person authorized by this Permit to apply for and/or obtain either an individual UPDES permit or an alternative UPDES general permit. Any interested person may petition the Executive Secretary to take action under this paragraph. Where the Executive Secretary requires a discharger authorized to discharge under this Permit to apply for an individual UPDES permit, the Executive Secretary shall notify the discharger in writing that a permit application is required. This notification shall include a brief statement of the reasons for this decision, an application form or reference to the application requirements, a statement setting a deadline for the discharger to file the application, and a statement that on the effective date of issuance or denial of the individual UPDES permit or the alternative general permit as it applies to the individual Permittee, coverage under this general Permit shall automatically terminate. Applications shall be submitted to the address of the Division of Water Quality shown in Part 5.11 of this Permit. The Executive Secretary may grant additional time to submit the application upon request of the applicant. If a discharger fails to submit in a timely manner an individual UPDES permit application as required by the Executive Secretary under this paragraph, then the applicability of this Permit to the individual UPDES permittee is automatically terminated at the end of the day specified for application submittal.
- 2.3.2. Any discharger authorized by this Permit may request to be excluded from the coverage of this Permit by applying for an individual permit. In such cases, the discharger shall submit an individual application in accordance with the requirements of Utah Administrative Code ("UAC") R317-8-3.9(2)(b)2 with reasons supporting the request, to the Executive Secretary at the address for the Division of Water Quality in Part 5.11 of this Permit. The request may be granted by issuance of any individual permit or an alternative general permit if the reasons cited by the Permittee are adequate to support the request.
- 2.3.3. When an individual UPDES permit is issued to a discharger who would otherwise be subject to this Permit, or the discharger is authorized to discharge under an alternative UPDES general permit, the applicability of this Permit to the individual UPDES permittee is automatically terminated on the effective date of the individual permit or the date of authorization for coverage under the alternative general permit, whichever the case may be. When an individual UPDES permit is denied to a discharger otherwise subject to this Permit or the discharger is denied for coverage under an alternative UPDES general permit, the applicability of this Permit to the

individual UPDES permittee is automatically terminated on the date of such denial, unless otherwise specified by the Executive Secretary.

- 2.4 Continuation of the Expired General Permit. This Permit expires on June 30, 2013. However, an expired general permit shall continue in force and effect after the expiration date until a new general permit is issued. If a discharger was eligible for and permitted under this Permit, and this Permit expires, the discharger will remain covered by this Permit until the earliest of:
- 2.4.1. One hundred twenty days after re-issuance or replacement of this Permit;
 - 2.4.2. The discharger submits a Notice of Termination in compliance with this Permit;
 - 2.4.3. The discharger is issued an individual permit for the project's discharges; or
 - 2.4.4. 180 days after the Executive Secretary makes a formal decision not to reissue or replace this Permit, at which time the discharger must seek coverage under an alternative general permit or an individual permit.

PART 3. STORM WATER POLLUTION PREVENTION PLANS

- 3.1. SWPPP required. A Storm Water Pollution Prevention Plan (“SWPPP”) shall be developed for each construction project covered by this Permit prior to submission of an NOI. A SWPPP shall be prepared in accordance with good engineering practices. It is recommended that the plan be signed by a Professional Engineer (P.E.) registered in the State. The SWPPP shall identify potential sources of pollution which may reasonably be expected to affect the quality of storm water discharges from the construction site, shall describe and ensure the implementation of practices which will be used to reduce the pollutants in storm water discharges associated with construction activity at the construction site and to assure compliance with the terms and conditions of this Permit, and shall otherwise meet the requirements of this Permit. As a condition of this Permit, Permittees must implement the SWPPP as written or modified from commencement of construction until final stabilization is complete and an NOT has been submitted. (This provision is not intended to address the potential liability of a Permittee or other current or former operator or owner in the event of a discharge of pollution from the property of an individual homeowner.)
- 3.2. SWPPP Location, Availability, Revision, and Signature.
 - 3.2.1. SWPPP Location. A copy of the SWPPP, including a copy of the Permit, the NOI, and any amendments to the SWPPP, shall be retained on-site at the site which generates the storm water discharge in accordance with this Part 3.2 and with Part 5.10 of this Permit. If the site is inactive or does not have an onsite location adequate to store the copy of the SWPPP, reasonable local access to a copy of the SWPPP during normal working hours (e.g., at a local library or government building), must be provided and the location of the SWPPP, along with a contact phone number, shall be posted on site at a publicly-accessible location. For linear construction projects, such as pipelines, the posted notice shall be located at a publicly accessible location near the active part of the construction project.
 - 3.2.2. SWPPP Availability. The Permittee shall make the copy of the SWPPP that is kept on-site or kept locally available for review upon request to the Executive Secretary; EPA; other local agencies approving sediment and erosion plans, grading plans, or storm water management plans; local government officials; or to the operators of a municipal separate storm sewer receiving discharges from the site. The Permittee need not provide a free copy of the SWPPP to these entities upon request, but if it chooses not to do so, it shall keep two copies of the SWPPP, in its entirety, and shall allow these entities to borrow one to make a copy at their own expense.
 - 3.2.3. Original SWPPP. If requested by the Executive Secretary, the original SWPPP, including any previous versions requested, shall be provided to the Executive Secretary within five working days of the request. The original provided shall be signed in accordance with Part 5.16 of this Permit.
 - 3.2.4. SWPPP Availability to the Public. The Permittee shall also make a copy of the SWPPP available to the public to review at reasonable times during regular business hours. Advance notice by the public of the desire to view the SWPPP may be required, not to exceed two working days. The Permittee need not provide a free copy of the SWPPP to members of the public, but if it chooses not to do so, it shall

- keep two copies of the SWPPP, in its entirety, and shall allow members of the public to borrow one to make a copy at their own expense.
- 3.2.5. Compelled Revisions. The Executive Secretary, or an authorized representative of the Executive Secretary, may notify the Permittee (co-Permittees) at any time that the SWPPP does not meet one or more of the minimum requirements of this Part 3. Such notification shall identify those provisions of the Permit which are not being met by the SWPPP, and identify which provisions of the SWPPP require modifications in order to meet the minimum requirements of this Part 3. Within 7 days of such notification from the Executive Secretary, (or as otherwise provided by the Executive Secretary), or authorized representative, the Permittee shall make the required changes to the SWPPP and shall submit to the Executive Secretary a written certification that the changes have been made. The Executive Secretary may take appropriate enforcement action for the period of time the Permittee was operating under a SWPPP that did not meet the minimum requirements of the Permit.
- 3.2.6. All SWPPPs must be signed and certified in accordance with Part 5.16 of this Permit.
- 3.3. Keeping SWPPPs Current.
- 3.3.1. The Permittee shall amend the SWPPP whenever there is a change in design, construction, operation, or maintenance, which has a significant effect on the discharge of pollutants to the waters of the State and which has not otherwise been addressed in the SWPPP.
- 3.3.2. The Permittee shall amend the SWPPP whenever inspections or investigations by site operators, local, state, or federal officials indicate the SWPPP is proving ineffective in eliminating or significantly minimizing pollutants from sources identified under Part 3.5.1 of this Permit, or is otherwise not achieving the general objectives of controlling pollutants in storm water discharges associated with construction activity.
- 3.3.3. The Permittee shall amend the SWPPP whenever a new owner/operator becomes responsible for implementing all or part of the SWPPP, as further described in Part 3.4 and Part 4.3 of this Permit.
- 3.3.4. The following records of activities shall be maintained as part of the SWPPP:
- Dates when major grading activities occur;
 - Dates when construction activities temporarily or permanently cease on a portion of or all of the site; and
 - Dates when stabilization measures are initiated.
- 3.3.5. Once an area has been finally stabilized, the Permittee may identify this area in the SWPPP and no further SWPPP or inspection requirements shall apply to that area.
- 3.4. More than one Permittee. A SWPPP may identify more than one Permittee and may specify the responsibilities of each Permittee by task, area, and/or timing. Permittees may coordinate and prepare more than one SWPPP to accomplish this. However, in the event there is a requirement under the SWPPP for which responsibility is ambiguous or is not included in the SWPPP(s), each Permittee shall be responsible for implementation of that requirement. Each Permittee is also responsible for assuring that its activities do not render another Permittee's controls ineffective.

3.5. Contents of SWPPP. The SWPPP shall include the following items:

3.5.1. Site Description. Each SWPPP shall provide a description of pollutant sources and other information as indicated:

- a. A description of the nature of the construction activity;
- b. A description of the intended sequence of major activities which disturb soils for major portions of the site (e.g. grubbing, excavation, grading, utilities, and infrastructure installation);
- c. Estimates of the total area of the site and the total area of the site that is expected to be disturbed by excavation, grading, or other activities, including areas for construction support;
- d. An estimate of the runoff coefficient of the site after construction activities are completed and existing data describing the soil or the quality of any discharge from the site;
- e. A general location map (e.g. portion of a city or county map or similar scale) and a site map indicating:
 - 1) drainage patterns and approximate slopes anticipated after major grading activities;
 - 2) construction boundaries and a description of existing vegetation prior to grading activities;
 - 3) areas of soil disturbance, and areas of no disturbance;
 - 4) the location of major structures and nonstructural controls identified in the SWPPP;
 - 5) Locations of areas used for construction support;
 - 6) the location of areas where stabilization practices are expected to occur;
 - 7) the location of surface waters (including wetlands); and
 - 8) locations where storm water is discharged or will discharge to a surface water;
- f. A description of any discharge associated with industrial activity other than construction at the site (including storm water discharges from dedicated portable asphalt plants and dedicated portable concrete plants), whether or not those discharges are covered by the Permit; and the location of that activity;
- g. The name of the receiving water(s), and aerial extent of wetland acreage at the site; and
- h. A copy of this Permit.

3.5.2. Controls. The SWPPP shall employ best management practices to control pollutants in storm water discharges. Each plan shall include a description of appropriate controls and measures that will be implemented during construction activity and while the site is unstabilized. The plan must clearly describe for each major activity identified in Part 3.5.1(b) appropriate control measures and the timing during the construction process that the measures will be implemented. The description and implementation of controls shall address the following minimum components:

- a. Erosion and Sediment Controls.
 - 1) Short and Long Term Goals and Criteria:
 - A) The construction-phase erosion and sediment controls should be designed to retain sediment on site to the maximum extent

- practicable.
- B) All control measures must be properly selected, installed, and maintained in accordance with the manufacturer's specifications and good engineering practices. If periodic inspections or other information indicates a control has been used inappropriately, incorrectly, or is ineffective the Permittee must replace or modify the control for site situations.
 - C) If sediments escape the construction site, off-site accumulations of sediment must be removed at a frequency sufficient to minimize the possibility of offsite impacts such as fugitive sediments washing into storm sewers by the next rain or posing a safety hazard to users of public streets.
 - D) Sediment must be removed from sediment traps or sedimentation ponds when design capacity has been reduced by 50%.
 - E) Litter, construction debris, and construction chemicals exposed to storm water shall be picked up prior to anticipated storm events (e.g. forecasted by local weather reports), or otherwise prevented from becoming a pollutant source for storm water discharges (e.g. screening outfalls, picked up daily, etc.).
 - F) Offsite material storage areas (also including overburden and stockpiles of dirt, etc.) used solely by the Permitted project are considered a part of the project and, unless a Permittee submits a separate NOI for such areas or they are subject to a separate UPDES permit, they shall be addressed in the SWPPP.
- 2) Stabilization Practices. A description of existing interim and permanent stabilization practices, including site-specific scheduling of the implementation of the practices. SWPPPs should ensure that existing vegetation is preserved where attainable and that disturbed portions of the site are stabilized. Stabilization practices may include: temporary seeding, permanent seeding, mulching, geo-textiles, sod stabilization, vegetative buffer strips, protection of trees, preservation of mature vegetation, and other appropriate measures. Use of impervious surfaces for stabilization should be avoided. Except as provided in paragraphs (A) and (B) below (Parts 3.5.2(a)(2)(A) and (B)), stabilization measures shall be initiated as soon as practicable in portions of the site where construction activities have temporarily or permanently ceased, but in no case more than 14 days after the construction activity in that portion of the site has temporarily or permanently ceased.
- A) Where the initiation of stabilization measures by the 14th day after construction activity temporarily or permanently ceases is precluded by snow cover or frozen ground conditions, stabilization measures shall be initiated as soon as practicable.
 - B) Where construction activity on a portion of the site is temporarily ceased, and earth disturbing activities will be resumed within 21 days, temporary stabilization measures do not have to be initiated on that portion of the site.
- 3) Structural Practices. The permittee shall provide a description of

structural practices that divert flows from exposed soils, store flows or otherwise limit runoff and the discharge of pollutants from exposed areas of the site to the degree attainable. Such practices may include silt fences, earth dikes, drainage swales, sediment traps, check dams, subsurface drains, pipe slope drains, level spreaders, storm drain inlet protection, rock outlet protection, reinforced soil retaining systems, gabions, and temporary or permanent sediment basins. Placement of structural practices in floodplains should be avoided to the degree attainable. The installation of these devices may be subject to Section 404 of the federal Clean Water Act (“CWA”).

- A) 10 Acre Sediment Basin Requirement. Where attainable, for common drainage locations that serve areas with 10 or more acres disturbed at one time, the Permittee shall provide a temporary (or permanent) sediment basin that provides storage for a 10 year, 24 hour storm event, a calculated volume of runoff for disturbed acres drained, or equivalent control measures, until final stabilization of the site. Where calculations are not performed, a sediment basin providing 3,600 cubic feet of storage per acre drained (a 1 inch storm event), or equivalent control measures, shall be provided where attainable until final stabilization of the site. The required sizing of the sediment basin does not include flows from offsite areas and flows from onsite areas that are either undisturbed or have undergone final stabilization where such flows are diverted around both the disturbed area and the sediment basin. In determining whether installing a sediment basin is attainable, factors such as site soils, slope, and available area on site shall be considered. For drainage locations which serve 10 or more disturbed acres at one time and where a temporary sediment basin or equivalent controls is not attainable, smaller sediment basins and/or sediment traps (with comparable storage) must be used; or
- (i) at a minimum, equivalent controls in silt fences, vegetative buffer strips, sod, mulch, geo-textiles, stepped check dams, pipe slope drains or other sediment or erosion controls are required for all erodible areas, down slope boundaries of the construction area and side slope boundaries deemed appropriate as dictated by individual site conditions; or
 - (ii) it can be shown that site meteorological conditions do not warrant equivalent storage during the time period the 10-acres are destabilized (little or no chance of precipitation for the period of surface destabilization).
- B) Less Than 10 Acre BMP Requirement. For drainage locations serving less than 10 acres, sediment basins and/or sediment traps should be used. At a minimum, silt fences, vegetative buffer strips, or equivalent sediment controls are required for all down slope boundaries (and those side slope boundaries deemed appropriate as dictated by individual site conditions) of the construction area unless a sediment basin providing storage for

3,600 cubic feet of storage per acre drained is provided.

- b. Storm Water Management. Description of measures that will be installed during the construction process to control pollutants in storm water discharges that will occur after construction operations have been completed. Structural measures should be placed on upland soils to the degree attainable. The installation of these devices may be subject to Section 404 of the CWA. This Permit only addresses the installation of storm water management measures, and not the ultimate operation and maintenance of such structures after the construction activities have been completed and the site has undergone final stabilization. Permittees are only responsible for the installation and maintenance of storm water management measures prior to final stabilization of the site, and are not responsible for maintenance after storm water discharges associated with construction activity have been eliminated from the site. However, post-construction storm water BMPs that discharge pollutants from point sources once construction is completed, may in themselves, need authorization under a separate UPDES permit and are likely regulated under local municipal requirements.
- 1) Such measures may include:
 - A) storm water detention structures (including wet ponds);
 - B) storm water retention structures;
 - C) flow-attenuation by use of open vegetated swales and natural depressions;
 - D) infiltration of runoff onsite; and
 - E) sequential systems (which combine several practices).
 - 2) The SWPPP shall include an explanation of the technical basis used to select the practices to control pollution where flows exceed predevelopment levels.
 - 3) Storm water velocity dissipation devices shall be placed at discharge locations and along the length of any outfall channel for the purpose of providing a non-erosive flow velocity from the structure to a water course so that the natural physical and biological characteristics and functions are maintained and protected. The objective is to minimize significant changes in the hydrological regime of the receiving water.
- c. Other Controls.
- 1) Waste Disposal. No solid materials, including building materials, shall be discharged to waters of the State, except as authorized by a federal CWA Section 404 permits.
 - 2) Off-site Tracking. Off-site vehicle tracking of sediments and the generation of dust shall be minimized.
 - 3) Septic, Waste, and Sanitary Sewer Disposal. The SWPPP shall ensure and demonstrate compliance with applicable State and/or local waste disposal, sanitary sewer or septic system regulations.
 - 4) Exposure to Construction Materials. The SWPPP shall include a narrative description of practices to reduce pollutants from construction related materials which are stored onsite including an inventory of construction materials (including waste materials), storage practices to minimize exposure of the materials to storm water, and spill prevention and

response.

- 5) Support Areas. A description of pollutant sources from areas other than construction (including storm water discharges from dedicated portable asphalt plants and dedicated portable concrete plants), and a description of controls and measures that will be implemented at those sites.

d. Other Laws and Requirements.

- 1) Local Storm Water Control Requirements. This Permit does not relieve the Permittee from compliance with other laws effecting erosion and sediment control or requirements for the permanent storm water system. Where applicable, compliance efforts to these requirements should be reflected in the SWPPP.
- 2) Threatened or Endangered Species & Historic Properties. This Permit does not relieve the Permittee from compliance with Federal or State laws pertaining to threatened or endangered species or historic properties. Where applicable compliance efforts to these laws should be reflected in the SWPPP.
- 3) Variance of Permit Requirements. Dischargers seeking alternative permit requirements shall submit an individual UPDES permit application in accordance with applicable law to the address indicated in Part 5.11 of this Permit, along with a description of why requirements in this Permit should not be applicable as a condition of a UPDES permit.

3.5.3. Maintenance. All vegetation, erosion and sediment control measures and other protective measures identified in the SWPPP shall be maintained in effective operating condition. A description of procedures to ensure the timely maintenance of these measures shall be identified in the SWPPP. Maintenance needs identified in inspections or by other means shall be accomplished before the next anticipated storm event, or as necessary to maintain the continued effectiveness of storm water controls. If maintenance prior to the next anticipated storm event is impracticable, maintenance must be scheduled and accomplished as soon as practicable.

3.5.4. Inspections.

- a. Inspections must be conducted in accordance with one of the two schedules listed below. The Permittee shall specify in its SWPPP which schedule it will be following.
 - 1) At least once every 7 calendar days; or
 - 2) At least once every 14 calendar days and within 24 hours of the end of a storm event of 0.5 inches or greater.
- b. Inspection frequency may be reduced to at least once every month if:
 - 1) The entire site is temporarily stabilized; or
 - 2) Runoff is unlikely due to winter conditions (e.g., site is covered with snow, ice, or the ground is frozen).
- c. The inspection requirement is waived until one month before thawing conditions are expected to result in a discharge if all of the following requirements are met:
 - 1) The project is located in an area where frozen conditions are anticipated to continue for extended periods of time (i.e., more than one month);

- 2) Land disturbance activities have been suspended; and
 - 3) The beginning and ending dates of the waiver period are documented in the SWPPP.
- d. Inspections must be conducted by qualified personnel (provided by the operator or cooperatively by multiple operators). "Qualified personnel" means a person knowledgeable in the principles and practice of erosion and sediment controls who possesses the skills to assess conditions at the construction site that could impact storm water quality and to assess the effectiveness of any sediment and erosion control measures selected to control the quality of storm water discharges from the construction activity.
- e. Inspections must include all areas of the site disturbed by construction activity and areas used for storage of materials that are exposed to precipitation. Inspectors must look for evidence of, or the potential for, pollutants entering the storm water conveyance system. Sedimentation and erosion control measures identified in the SWPPP must be observed to ensure proper operation. Discharge locations must be inspected to ascertain whether erosion control measures are effective in preventing significant impacts to waters of the United States, where accessible. Where discharge locations are inaccessible, nearby downstream locations must be inspected to the extent that such inspections are practicable. Locations where vehicles enter or exit the site must be inspected for evidence of off-site sediment tracking.
- f. Inspections at construction sites involving utility line installation, pipeline construction, and other long, narrow, linear construction may be more limited if the areas described in Part 3.5.4(e) of this Permit are not reasonably accessible or could cause additional disturbance of soils and increase the potential for erosion. In these circumstances, controls must be inspected at the same frequency as other construction projects, but personnel may instead inspect controls along the construction site for 0.25 mile above and below each access point where a roadway, undisturbed right-of-way, or other similar feature intersects the construction site and allows access to the areas described above. In the absence of evidence to the contrary, the conditions of the controls along each inspected 0.25 mile segment may be considered as representative of the condition of controls along that reach extending from the end of the 0.25 mile segment to either the end of the next 0.25 mile inspected segment, or to the end of the project, whichever occurs first.
- g. For each inspection required above, the inspector must complete an inspection report. At a minimum, the inspection report must include:
- 1) The inspection date;
 - 2) Names, titles, and qualifications of personnel making the inspection;
 - 3) Weather information for the period since the last inspection (or since commencement of construction activity if the first inspection) including a best estimate of the beginning of each storm event, duration of each storm event, approximate amount of rainfall for each storm event (in inches), and whether any discharges occurred;
 - 4) Weather information and a description of any discharges occurring at the time of the inspection;
 - 5) Location(s) of discharges of sediment or other pollutants from the site;

- 6) Location(s) of BMPs that need to be maintained;
 - 7) Location(s) of BMPs that failed to operate as designed or proved inadequate for a particular location;
 - 8) Location(s) where additional BMPs are needed that did not exist at the time of inspection; and
 - 9) Corrective action required including any changes to the SWPPP necessary and implementation dates.
- h. A record of each inspection and of any actions taken in accordance with this Part 3 must be retained as part of the SWPPP for at least three years from the date that permit coverage expires or is terminated. The inspection reports must identify any incidents of non-compliance with the permit conditions. Where a report does not identify any incidents of non-compliance, the report must contain a certification that the construction project or site is in compliance with the SWPPP and this permit. The report must be signed in accordance with Part 5.16 of this Permit.

3.5.5. Non-Storm Water Discharges. Except for flows from fire fighting activities, sources of non-storm water listed in Part 1.5 of this Permit that are combined with storm water discharges associated with industrial activity must be identified in the SWPPP. The SWPPP shall identify and ensure the implementation of appropriate pollution prevention measures for the non-storm water component(s) of the discharge.

PART 4 . TERMINATION/CHANGES IN OWNER/OPERATOR FOR SITE

- 4.1. Termination of Coverage: Permittees may or shall (as specified) terminate coverage under this Permit under the following conditions:
- 4.1.1. Completion of construction activities and site stabilization: Permittees shall terminate coverage under this Permit by submitting a Notice of Termination (“NOT”) within thirty days after completion of all construction activities, completion of final stabilization of all areas of the site as defined in Part 6.15. The NOT shall be submitted on the form specified by the Executive Secretary.
- 4.1.2. Partial completion of construction activities and site stabilization: A Permittee who, as specified in Part 3.4 of this Permit, is identified in the SWPPP as responsible for a specific area may terminate coverage under this Permit by submitting an NOT within thirty days after completion, for that area, of all construction activities, completion of final stabilization of all areas for which the Permittee was responsible and that were disturbed. The NOT shall be submitted on the form specified by the Executive Secretary, and the Permittee shall indicate on the form that it is a partial NOT.
- 4.1.3. New responsible owner/operator: A Permittee may terminate its coverage under this Permit by submitting an NOT if another party (or parties) assumes responsibility for all remaining SWPPP requirements. Termination of the Permittee’s responsibilities under the SWPPP will not be final until the other party (or parties) submits an NOI. If the new responsible owner/operator fails to submit an NOI, the Permittee may complete termination by demonstrating to the Executive Secretary that it has entered into contracts that obligate the new owner/operator to undertake all remaining responsibilities under the SWPPP.
- 4.2. Conditions for Submitting an NOT: A Permittee may not submit an NOT unless it meets the requirements specified in Part 4.1. Appropriate enforcement actions may be taken if an NOT is submitted without these requirements having been met, and the Permittee may also continue to be responsible for any Permit violations.
- 4.3. Updating the SWPPP: If an NOT is submitted under Part 4.1.2 or 4.1.3, the SWPPP shall be updated by the remaining Permittee(s) to meet the requirements of Part 3.4 of the Permit.

PART 5. STANDARD PERMIT CONDITIONS

5.1. Duty to Comply.

5.1.1. The Permittee must comply with all conditions of this Permit. Any Permit noncompliance constitutes a violation of the Act and is grounds for enforcement action; for Permit termination, revocation and reissuance, or modification; or for denial of a permit renewal application.

5.1.2. Penalties for Violations of Permit Conditions.

a. Violations. The Act provides that any person who violates the Act, Utah wastewater rules, or conditions of a permit issued under the Act is subject to a fine of \$10,000 per day.

b. Willful or Gross Negligence. The Act provides that any person who discharges a pollutant to waters of the State as a result of criminal negligence or who intentionally discharges is criminally liable and is subject to imprisonment and a fine of up to \$50,000 per day. Utah Code Ann. § 19-5-115.

c. False Statements. The Act provides that any person who knowingly makes any false material statement, representation, or certification in any application, record, report, plan, or other document filed or required to be maintained under the Act, the rules, or this Permit, or who knowingly falsifies, tampers with, or renders inaccurate, any monitoring device or method required to be maintained under the Act shall upon conviction, be punished by a fine of not more than \$10,000 or by imprisonment for 6 months, or by both. Utah Code Ann. § 19-5-115(4).

5.2. Duty to Reapply. If a Permittee wishes to continue an activity regulated by this permit after the expiration date of this permit, it must apply for and obtain a new permit except as provided in Part 2.4 of this Permit.

5.3. Need to halt or reduce activity not a defense. It shall not be a defense for a Permittee in an enforcement action that it would have been necessary to halt or reduce the permitted activity in order to maintain compliance with the conditions of this Permit.

5.4. Duty to Mitigate. The Permittee shall take all reasonable steps to minimize or prevent any discharge in violation of this Permit which has a reasonable likelihood of adversely affecting human health or the environment.

5.5. Duty to Provide Information. The Permittee shall furnish to the Executive Secretary or an authorized representative, within a reasonable time, any information which is requested to determine compliance with this Permit. The Permittee must also furnish to the Executive Secretary or an authorized representative copies of records to be kept by this Permit.

5.6. Other Information. When the Permittee becomes aware that he or she failed to submit any relevant facts or submitted incorrect information in the Notice of Intent or in any other report to the Executive Secretary, he or she shall promptly submit such facts or information.

- 5.7. Oil and Hazardous Substance Liability. Nothing in this Permit shall be construed to preclude the institution of any legal action or relieve the Permittee from any responsibilities, liabilities, or penalties to which the Permittee is or may be subject under the "Act".
- 5.8. Property Rights. The issuance of this Permit does not convey any property rights of any sort, nor any exclusive privileges, nor does it authorize any injury to private property nor any invasion of personal rights, nor any infringement of Federal, State or local laws or regulations.
- 5.9. Severability. The provisions of this Permit are severable, and if any provision of this Permit, or the application of any provision of this Permit to any circumstance, is held invalid, the application of such provision to other circumstances, and the remainder of this Permit shall not be affected thereby.
- 5.10. Record Retention.
- 5.10.1. The Permittee shall retain copies of SWPPPs and all reports required by this Permit, and records of all data used to complete the Notice of Intent to be covered by this Permit, for a period of at least three years from the date that the site is finally stabilized. This period may be extended by request of the Executive Secretary at any time.
- 5.10.2. After final stabilization of the construction site is complete, the SWPPP is no longer required to be maintained on site, but may be maintained by the Permittee(s) at its primary headquarters. Access to the SWPPP will continue as described in Part 3.2, however.
- 5.11. Addresses. All written correspondence under this permit shall be directed to the Division of Water Quality at the following address:
- Department of Environmental Quality
Division of Water Quality
288 North 1460 West
PO Box 144870
Salt Lake City, Utah 84114-4870
- 5.12. State Laws.
- 5.12.1. Nothing in this Permit shall be construed to preclude the institution of any legal action or relieve the Permittee from any responsibilities, liabilities, or penalties established pursuant to any applicable State law or regulation under authority preserved by Utah Code Ann. § 19-5-117.
- 5.12.2. No condition of this Permit shall release the Permittee from any responsibility or requirements under other environmental statutes or regulations.
- 5.13. Proper Operation and Maintenance. The Permittee shall at all times properly operate and maintain all facilities and systems of treatment and control (and related appurtenances) which are installed or used by the Permittee to achieve compliance with the conditions

of this Permit and with the requirements of SWPPPs. Proper operation and maintenance also includes adequate laboratory controls and appropriate quality assurance procedures. Proper operation and maintenance requires the operation of backup or auxiliary facilities or similar systems, installed by a Permittee only when necessary to achieve compliance with the conditions of the Permit.

5.14. Inspection and Entry. The Permittee shall allow, upon presentation of credentials, the Executive Secretary or an authorized representative:

- 5.14.1. To enter upon the Permittee's premises where a regulated facility or activity is located or conducted or where records must be kept under the conditions of this Permit;
- 5.14.2. Have access to and copy at reasonable times, any records that must be kept under the conditions of this Permit;
- 5.14.3. Inspect at reasonable times any facilities, equipment (including monitoring and control equipment), practices, or operations regulated or required under this Permit; and
- 5.14.4. Sample or monitor at reasonable times, for the purposes of assuring permit compliance or as otherwise authorized by law, any substances or parameters at any location.

5.15. Reopener Clause.

- 5.15.1. Reopener Due to Water Quality Impacts. If there is evidence indicating that the storm water discharges authorized by this Permit cause, have the reasonable potential to cause or contribute to, a violation of a water quality standard, the discharger may be required to obtain an individual permit or an alternative general permit in accordance with Part 2.3 of this Permit or the Permit may be modified to include different limitations and/or requirements.
- 5.15.2. Reopener Guidelines. Permit modification or revocation will be conducted according to UAC R317-8-5.6 and UAC R317-8-6.2.
- 5.15.3. Permit Actions. This Permit may be modified, revoked and reissued, or terminated for cause. The filing of a request by the Permittee for a Permit modification, revocation and reissuance, or termination, or a notification of planned changes or anticipated noncompliance does not stay any Permit condition.

5.16. Signatory Requirements.

- 5.16.1. All Notices of Intent, SWPPPs, reports, certifications or information submitted to the Executive Secretary, or that this Permit requires be maintained by the Permittee, shall be signed as follows:
 - a. All Notices of Intent shall be signed as follows:
 - 1) For a corporation: by a responsible corporate officer. For the purpose of this section, a responsible corporate officer means: a president, secretary, treasurer, or vice-president of the corporation in charge of a principal business function, or any other person who performs similar policy or decision-making functions for the corporation; or the manager of one or more manufacturing, production or operating facilities employing more than 250 persons or having gross annual sales or expenditures exceeding \$25,000,000 (in second-quarter 1980 dollars) if authority to sign

- documents has been assigned or delegated to the manager in accordance with corporate procedures;
- 2) For a partnership of sole proprietorship: by a general partner or the proprietor, respectively; or
 - 3) For a municipality, State, Federal, or other public agency: by either a principal executive officer or ranking elected official. For purposes of this section, a principal executive officer of a Federal agency includes (1) the chief executive officer of the agency, or (2) a senior executive officer having responsibility for the overall operations of a principal geographic unit of the agency (e.g. Regional Administrators of EPA).
- b. All reports required by the Permit and other information requested by the Executive Secretary or by an authorized representative of the Executive Secretary shall be signed by a person described above or by a duly authorized representative of that person. A person is a duly authorized representative only if:
- 1) The authorization is made in writing by a person described above and submitted to the Executive Secretary; and
 - 2) The authorization specifies either an individual or a position having responsibility for overall operation of the regulated site, facility or activity, such as the position of manager, operator, superintendent, or position of equivalent responsibility or an individual or position having overall responsibility for environmental matters for the company. (A duly authorized representative may thus be either a named individual or any individual occupying a named position).
- c. Certification. Any person signing documents under this Part 5.16 shall make the following certification:

I certify under penalty of law that this document and all attachments were prepared under my direction or supervision in accordance with a system designed to assure that qualified personnel properly gathered and evaluated the information submitted. Based on my inquiry of the person or persons who manage the system, or those persons directly responsible for gathering the information, the information submitted is, to the best of my knowledge and belief, true, accurate, and complete. I am aware that there are significant penalties for submitting false information, including the possibility of fine and imprisonment for knowing violations.

- 5.16.2. If a document is to be signed electronically, the Division's rules regarding electronic transactions govern.

PART 6. DEFINITIONS

As used in this Permit:

- 6.1. "Act" means the "Utah Water Quality Act"
- 6.2. "Best Management Practices" ("BMPs") means schedules of activities, prohibitions of practices, maintenance procedures, and other management practices to prevent or reduce the discharge of pollutants to waters of the State. BMPs also include treatment requirements, operating procedures, and practices to control plant site runoff, spillage or leaks, sludge or waste disposal, or drainage from raw material storage.
- 6.3. "Common plan of development or sale" means one plan for development or sale, separate parts of which are related by any announcement, piece of documentation (including a sign, public notice or hearing, sales pitch, advertisement, drawing, plat, blueprint, contract, permit application, zoning request, computer design, etc.), physical demarcation (including boundary signs, lot stakes, surveyor markings, etc.), or continuing obligation (including contracts) that identify the scope of the project. A plan may still be a common plan of development or sale even if it is taking place in separate stages or phases, is planned in combination with other construction activities, or is implemented by different owners or operators.
- 6.4. "Commencement of Construction" means the initial disturbance of soils associated with clearing, grading, or excavating activities or other construction activities.
- 6.5. "Construction activity" means soil disturbing activities such as clearing, grading, and excavating of land. The term also includes construction support activities.
- 6.6. "Construction support activities" means construction material and equipment storage and maintenance, concrete or asphalt batch plants, except as provided in Part 1.4.3 of this Permit.
- 6.7. "Control Measure" refers to any Best Management Practice or other method used to prevent or reduce the discharge of pollutants to waters of the State.
- 6.8. "CWA" means Clean Water Act or the Federal Water Pollution Control Act.
- 6.9. "Dedicated portable asphalt plant" means a portable asphalt plant that is located on or contiguous to a construction site and that provides asphalt only to the construction site that the plant is located on or adjacent to.
- 6.10. "Dedicated portable concrete plant" means a portable concrete plant that is located on or contiguous to a construction site and that provides concrete only to the construction site that the plant is located on or adjacent to.
- 6.11. "Discharge," when used without qualification, means the discharge of a pollutant.

- 6.12. "EPA" means the United States Environmental Protection Agency.
- 6.13. "Eligible" means qualified for authorization to discharge storm water under this general permit.
- 6.14. "Executive Secretary" means Executive Secretary of the Utah Water Quality Board.
- 6.15. "Final Stabilization" means that all soil disturbing activities at the site have been completed, and that a uniform (e.g. evenly distributed, without large bare areas) perennial vegetative cover with a density of 70% of the native background vegetative cover for the area has been established on all unpaved areas and areas not covered by permanent structures, or equivalent permanent stabilization measures (such as the use of riprap, gabions, or geo-textiles) have been employed. In some parts of the country, background native vegetation will cover less than 100% of the ground (e.g. arid areas). Establishing at least 70% of the natural cover of native vegetation meets the vegetative cover criteria for final stabilization. For example, if the native vegetation covers 50% of the ground, 70% of 50% would require 35% total cover for final stabilization. For individual lots in residential construction, final stabilization means that either the homebuilder has completed final stabilization as specified above, or the homebuilder has established temporary stabilization including perimeter controls for an individual lot prior to occupation of the home by the homeowner and has obligated the homeowner, by contract, to complete the requirements for final stabilization within two years.
- 6.16. "Indian Country" is defined as in 40 CFR §122.2 to mean:
1. All land within the limits of any Indian reservation under the jurisdiction of the United States Government, notwithstanding the issuance of any patent, and, including rights-of-way running through the reservation;
 2. All dependent Indian communities within the borders of the United States whether within the originally or subsequently acquired territory thereof, and whether within or without the limits of a state; and
 3. All Indian allotments, the Indian titles to which have not been extinguished, including rights-of-ways running through the same.
- 6.17. "Municipal Separate Storm Sewer System" refers to all separate storm sewers that are owned or operated by the United States, a State, city, town, county, district, association, or other public body having jurisdiction over disposal of sewage, industrial wastes, storm water, or other wastes, including special districts under State law such as a sewer districts, flood control districts or drainage districts, or similar entity that discharges to waters of the State.
- 6.18. "NOI" means notice of intent to be covered by this Permit.
- 6.19. "NOT" means notice of termination.
- 6.20. "Point Source" means any discernible, confined, and discrete conveyance, including but not limited to, any pipe, ditch, channel, tunnel, conduit, well, discrete fissure, container, rolling stock, concentrated animal feeding operation, landfill leachate collection system,

vessel or other floating craft from which pollutants are or may be discharged. This term does not include return flows from irrigated agriculture or agricultural storm water runoff.

- 6.21. "Runoff coefficient" means the fraction of total rainfall that will appear at conveyance as runoff.
- 6.22. "Site" means the land or water area where any "facility or activity" is physically located or conducted, including adjacent land used in connection with the facility or activity.
- 6.23. "Storm water" means storm water runoff, snow melt runoff, and surface runoff and drainage.
- 6.24. "Storm water discharge associated with industrial activity" is defined in the Utah Administrative Code (UAC) R317-8-3.9(6)(c) & (d) and incorporated here by reference. Most relevant to this Permit is UAC R317-8-3.9(6)(d)10, which relates to construction activity including clearing, grading and excavation activities.
- 6.25. SWPPP means Storm Water Pollution Prevention Plan, referring to the plan required in Part 3 of this Permit.
- 6.26. "Total Maximum Daily Load" or "TMDL" means the sum of the individual wasteload allocations (WLAs) for point sources and load allocations (LAs) for nonpoint sources and natural background. If a receiving water has only one point source discharger, the TMDL is the sum of that point source WLA plus the LAs for any nonpoint sources of pollution and natural background sources, tributaries, or adjacent segments. TMDLs can be expressed in terms of either mass per time, toxicity, or other appropriate measure.
- 6.27. Waters of the State means all streams, lakes, ponds, marshes, water-courses, waterways, wells, springs, irrigation systems, drainage systems, and all other bodies or accumulations of water, surface and underground, natural or artificial, public or private, which are contained within, flow through, or border upon this state or any portion thereof, except that bodies of water confined to and retained within the limits of private property, and which do not develop into or constitute a nuisance, or a public health hazard, or a menace to fish and wildlife, shall not be considered to be waters of the state (UAC R317-1-1.31).

Appendix D – NOI and Acknowledgement Letter from EPA/State/MS4

Appendix E – Inspection Reports

Erosion and Sediment Control Inspection and Corrective Action Report

Inspector: _____ Date: _____

Site Name and Location: _____

Current Weather Conditions: _____ Last Rain Event >.5": _____

Site Description: _____

BMP Designation	O.K	Not O.K.	BMP Condition, Corrective Action.
Construction Access Is the tracking pad Preventing sediment from Being tracked into the Street?			
Washout facility Are washout facilities (e.g. Paint, stucco, concrete) Available , clearly marked And maintained?			
Portable Toilet Is the portable toilet placed Behind the sidewalk or at Least 10' away from the Street properly anchored?			
Perimeter Control Clearing Limits Marked? Silt Fences?			
Inlet, Curb and Gutter Check Dam Sediment Protection Rock bags?			
Waste Disposal Is trash/litter from work Areas collected in a dumpsters or removed from the site daily			
Street Sweeping And Dust Control			
Other BMP Maintenance			

Appendix H – Subcontractor Certifications/Agreements

SUBCONTRACTOR CERTIFICATION STORMWATER POLLUTION PREVENTION PLAN

Project Number: _____

Project Title: _____

Operator(s): _____

As a subcontractor, you are required to comply with the Stormwater Pollution Prevention Plan (SWPPP) for any work that you perform on-site. Any person or group who violates any condition of the SWPPP may be subject to substantial penalties or loss of contract. You are encouraged to advise each of your employees working on this project of the requirements of the SWPPP. A copy of the SWPPP is available for your review at the office trailer.

Each subcontractor engaged in activities at the construction site that could impact stormwater must be identified and sign the following certification statement:

I certify under the penalty of law that I have read and understand the terms and conditions of the SWPPP for the above designated project and agree to follow the BMPs and practices described in the SWPPP.

This certification is hereby signed in reference to the above named project:

Company: _____

Address: _____

Telephone Number: _____

Type of construction service to be provided: _____

Signature: _____

Title: _____

Date: _____

Appendix I – Grading and Stabilization Activities Log

Project Name:
SWPPP Contact:

Date Grading Activity Initiated	Description of Grading Activity	Date Grading Activity Ceased (Indicate Temporary or Permanent)	Date When Stabilization Measures are Initiated	Description of Stabilization Measure and Location

Appendix J – SWPPP Training Log

Stormwater Pollution Prevention Training Log

Project Name: _____

Project Location: _____

Instructor's Name(s): _____

Instructor's Title(s): _____

Course Location: _____ Date: _____

Course Length (hours): _____

Stormwater Training Topic: *(check as appropriate)*

- Erosion Control BMPs Emergency Procedures
 Sediment Control BMPs Good Housekeeping BMPs
 Non-Stormwater BMPs

Specific Training Objective: _____

Attendee Roster: *(attach additional pages as necessary)*

No.	Name of Attendee	Company
1		
2		
3		
4		
5		
6		
7		
8		
9		
10		

Appendix K – Delegation of Authority Form

Delegation of Authority

I, _____ (name), hereby designate the person or specifically described position below to be a duly authorized representative for the purpose of overseeing compliance with environmental requirements, including the Construction General Permit, at the _____ construction site. The designee is authorized to sign any reports, stormwater pollution prevention plans and all other documents required by the permit.

_____ (name of person or position)
_____ (company)
_____ (address)
_____ (city, state, zip)
_____ (phone)

By signing this authorization, I confirm that I meet the requirements to make such a designation as set forth in _____ (Reference State Permit), and that the designee above meets the definition of a “duly authorized representative” as set forth in _____ (Reference State Permit).

I certify under penalty of law that this document and all attachments were prepared under my direction or supervision in accordance with a system designed to assure that qualified personnel properly gathered and evaluated the information submitted. Based on my inquiry of the person or persons who manage the system, or those persons directly responsible for gathering the information, the information submitted is, to the best of my knowledge and belief, true, accurate, and complete. I am aware that there are significant penalties for submitting false information, including the possibility of fine and imprisonment for knowing violations.

Name: _____

Company: _____

Title: _____

Signature: _____

Date: _____



OBJECTIVES

- New Development
- Residential
- Commercial Activities
- Industrial Activities
- Municipal Facilities
- Illegal Discharges



WEBER COUNTY

ENGINEERING DEPARTMENT

2380 Washington Blvd., Suite 240
Ogden, UT 84401
(801) 399-8374

DESCRIPTION:

Prevent or reduce the discharge of pollutants to stormwater from buildings and grounds maintenance by washing and cleaning up with as little water as possible, preventing and cleaning up spills immediately, and maintaining the stormwater collection system.

APPROACH:

- ▶ Preserve existing native vegetation to reduce water, fertilizer, and pesticide needs.
- ▶ Carefully use pesticides and fertilizers in landscaping.
- ▶ Take care in over-watering landscape sites to reduce the risk of discharge of water contaminated with nutrients and pesticides.
- ▶ Integrate pest management where appropriate.
- ▶ Sweep paved surfaces.
- ▶ Clean the storm drainage system at appropriated intervals, which includes marking storm drain inlets to minimize the dumping of inadvertent liquids.
- ▶ Properly dispose wash water, sweepings, and sediments.
- ▶ Take care of landscaped areas around the facility.
- ▶ Clean parking lots and areas other than industrial activity.
- ▶ Clean all catch basins in parking lots every 6 to 12 months or whenever the sump is full.
- ▶ Sweeping, either vacuum or mechanical, is the most appropriate BMP for cleaning parking lots and basins.

LIMITATIONS:

- ▶ Alternative pest/weed controls may not be available, suitable or effective in every case.

MAINTENANCE:

- ▶ The BMPs themselves relate to maintenance and do not require maintenance as they do not involve structures.

TARGETED POLLUTANTS

- Sediment
- Nutrients
- Heavy Metals
- Toxic Materials
- Oxygen Demanding Substance
- Oil & Grease
- Floatable Materials
- Bacteria & Viruses
- High Impact
- Medium Impact
- Low or Unknown Impact

IMPLEMENTATION REQUIREMENTS

- Capital Costs
- O&M Costs
- Regulatory
- Training
- Staffing
- Administrative
- High
- Medium
- Low

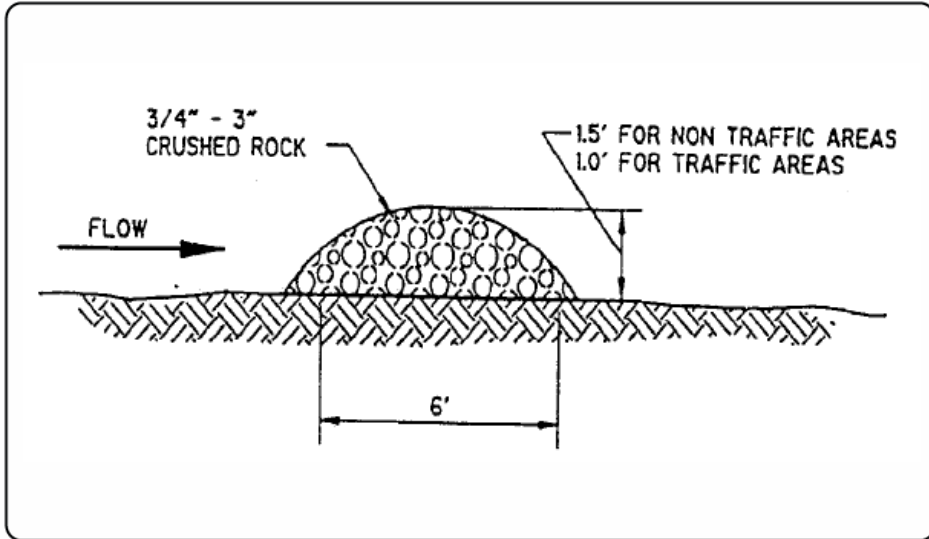

DESCRIPTION:

A rock filter is made of rock 3/4 - 3" in diameter and placed along a level contour. A brush filter is composed of brush (usually obtained during the site clearing) wrapped in filter cloth and anchored to the toe of the slope. If properly anchored brush or rock filters may be used for sediment trapping and velocity reduction.

APPLICATION:

- ▶ As check dams across mildly sloped construction roads.
- ▶ Below the toe of slopes.
- ▶ Along the site perimeter.
- ▶ In areas where sheet or rill flow occurs.
- ▶ Around temporary spoil areas.
- ▶ At sediment traps or culvert/pipe outlets.

INSTALLATION/APPLICATION CRITERIA:

- ▶ For rock filter, use larger rock and place in staked, woven wire sheathing if placed where concentrated flows occur.
- ▶ Install along a level contour.
- ▶ Leave area behind berm where runoff can pond and sediment can settle.
- ▶ Drainage areas should not exceed 5 acres.

LIMITATIONS:

- ▶ Rock berms may be difficult to remove.
- ▶ Removal problems limit their usefulness in landscaped areas.
- ▶ Runoff will pond upstream of the filter, possibly causing flooding if sufficient space does not exist.

MAINTENANCE:

- ▶ Inspect monthly after each rainfall.
- ▶ If berm is damaged, reshape and replace lost/dislodged rock.
- ▶ Remove sediment when depth reaches 1/3 of berm height, or 1 ft.

OBJECTIVES

- Housekeeping Practices
- Contain Waste
- Minimize Disturbed Areas
- Stabilize Disturbed Areas
- Protect Slopes/Channels
- Control Site Perimeter
- Control Internal Erosion



WEBER COUNTY

ENGINEERING DEPARTMENT

2380 Washington Blvd., Suite 240
Ogden, UT 84401
(801) 399-8374

TARGETED POLLUTANTS

- Sediment
- Nutrients
- Toxic Materials
- Oil & Grease
- Floatable Materials
- Other Waste

- High Impact
- Medium Impact
- Low or Unknown Impact

IMPLEMENTATION REQUIREMENTS

- Capital Costs
- O&M Costs
- Maintenance
- Training

- High
- Medium
- Low



OBJECTIVES

- New Development
- Residential
- Commercial Activities
- Industrial Activities
- Municipal Facilities
- Illegal Discharges



WEBER COUNTY

ENGINEERING DEPARTMENT

2380 Washington Blvd., Suite 240
Ogden, UT 84401
(801) 399-8374

DESCRIPTION:

Prevent or reduce the discharge of pollutants to stormwater from building repair, remodeling and construction by using soil erosion controls, enclosing or covering building material storage areas, using good housekeeping practices, using safer alternative products, and training employees.

APPROACH:

- ▶ Use soil erosion control techniques if bare ground is temporarily exposed.
- ▶ Use permanent soil erosion control techniques if the remodeling clears buildings that are not to be replaced.
- ▶ Enclose painting operations consistent with local air quality regulations and OSHA.
- ▶ Properly store materials that are normally used in repair and remodeling such as paints and solvents.
- ▶ Properly store and dispose waste materials generated from the activity.
- ▶ Maintain good housekeeping practices while work is underway.

LIMITATIONS:

- ▶ This BMP is for minor construction only.
- ▶ Hazardous waste that cannot be re-used or recycled must be disposed of by a licensed hazardous waste hauler.
- ▶ Safer alternative products may not be available, suitable, or effective in every case.
- ▶ Be certain that actions to help stormwater quality are consistent with OSHA and air quality regulations.

TARGETED POLLUTANTS

- Sediment
- Nutrients
- Heavy Metals
- Toxic Materials
- Oxygen Demanding Substance
- Oil & Grease
- Floatable Materials
- Bacteria & Viruses
- High Impact
- Medium Impact
- Low or Unknown Impact

IMPLEMENTATION REQUIREMENTS

- Capital Costs
- O&M Costs
- Regulatory
- Training
- Staffing
- Administrative
- High
- Medium
- Low

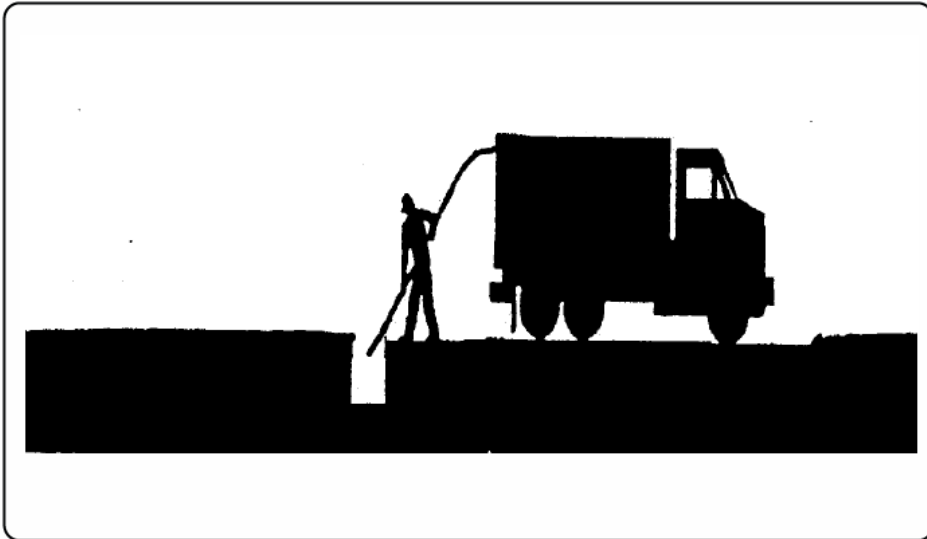

OBJECTIVES

- New Development
- Residential
- Commercial Activities
- Industrial Activities
- Municipal Facilities
- Illegal Discharges



WEBER COUNTY

ENGINEERING DEPARTMENT

2380 Washington Blvd., Suite 240
Ogden, UT 84401
(801) 399-8374

DESCRIPTION:

Maintain catch basin and stormwater inlets on a regular basis to remove pollutants, reduce high pollutant concentrations during the first flush of storms, prevent clogging of the downstream conveyance system, and restore the catch basins' sediment trapping capacity. A catch basin is distinguished from a stormwater inlet by having at its base a sediment sump designed to catch and retain sediments below the overflow point. This information sheet focuses on the cleaning of accumulated sediments from catch basins.

APPROACH:

Regular maintenance of catch basins and inlets is necessary to ensure their proper functioning. Clogged catch basins are not only useless but may act as a source of sediments and pollutants. In general, the key to effective catch basins are:

- ▶ At least annual inspections.
- ▶ Prioritize maintenance to clean catch basins and inlets in areas with the highest pollutant loading.
- ▶ Clean catch basins in high pollutant load areas just before the wet season to remove sediments and debris accumulated during the summer.
- ▶ Keep accurate logs of the number of catch basins cleaned.
- ▶ Record the amount of waste collected.

LIMITATIONS:

- ▶ There are no major limitations to this best management practice.

MAINTENANCE:

Regular maintenance of public and private catch basins and inlets is necessary to ensure their proper functioning. Clogged catch basins are not only useless but may act as a source of sediments and pollutants. In general, the keys to effective catch basins are:

- ▶ Annual/monthly inspection of public and private facilities to ensure structural integrity, a clean sump, and a stenciling of catch basins and inlets.
- ▶ Keep logs of the number of catch basins cleaned.
- ▶ Record the amount of waste collected.

TARGETED POLLUTANTS

- Sediment
- Nutrients
- Heavy Metals
- Toxic Materials
- Oxygen Demanding Substance
- Oil & Grease
- Floatable Materials
- Bacteria & Viruses

- High Impact
- Medium Impact
- Low or Unknown Impact

IMPLEMENTATION REQUIREMENTS

- Capital Costs
- O&M Costs
- Regulatory
- Training
- Staffing
- Administrative

- High
- Medium
- Low



OBJECTIVES

- New Development
- Residential
- Commercial Activities
- Industrial Activities
- Municipal Facilities
- Illegal Discharges

DESCRIPTION:

Prevent or reduce the discharge of pollutants to stormwater from contaminated or erodible surface areas by leaving as much vegetation on-site as possible, minimizing soil exposure time, stabilizing exposed soils, and preventing stormwater runoff and runoff.

APPROACH:

This BMP addresses soils which are not so contaminated as to exceed criteria but the soil is eroding and carrying pollutants off in the stormwater.

Contaminated or erodible surface areas can be controlled by:

- ▶ Preservation of natural vegetation,
- ▶ Re-vegetation,
- ▶ Chemical stabilization,
- ▶ Removal of contaminated soils, or
- ▶ Geosynthetics.

LIMITATIONS:

Disadvantages of preserving natural vegetation or re-vegetating include:

- ▶ Requires substantial planning to preserve and maintain the existing vegetation.
- ▶ May not be cost-effective with high land costs.
- ▶ Lack of rainfall and/or poor soils may limit the success of re-vegetated areas.

Disadvantages of chemical stabilization include:

- ▶ Creation of impervious surfaces.
- ▶ May cause harmful effects on water quality.
- ▶ Is usually more expensive than vegetative cover.

MAINTENANCE:

- ▶ Maintenance should be minimal, except if irrigation of vegetation is necessary.



WEBER COUNTY

ENGINEERING DEPARTMENT

2380 Washington Blvd., Suite 240
Ogden, UT 84401
(801) 399-8374

TARGETED POLLUTANTS

- Sediment
- Nutrients
- Heavy Metals
- Toxic Materials
- Oxygen Demanding Substance
- Oil & Grease
- Floatable Materials
- Bacteria & Viruses
- High Impact
- Medium Impact
- Low or Unknown Impact

IMPLEMENTATION REQUIREMENTS

- Capital Costs
- O&M Costs
- Regulatory
- Training
- Staffing
- Administrative
- High
- Medium
- Low

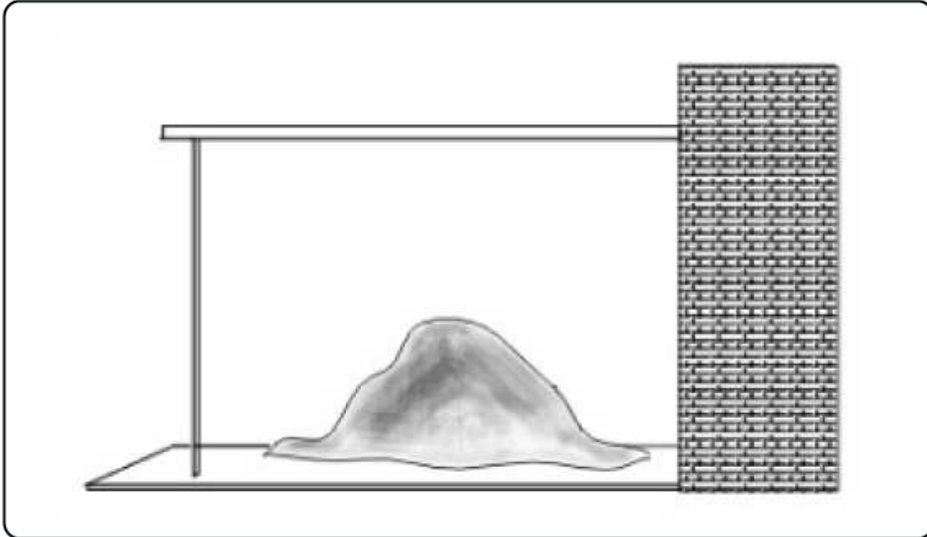

DESCRIPTION:

Covering is the partial or total physical enclosure of materials, equipment, process operations, or activities. Covering certain areas or activities prevents stormwater from coming into contact with potential pollutants and reduces material loss from wind blowing. Tarpaulins, plastic sheeting, roofs, buildings, and other enclosures are examples of covering that are effective in preventing stormwater contamination. Covering can be temporary or permanent.

APPROACH:

- ▶ Covering is appropriate for outdoor material storage piles (e.g., stockpiles of dry materials, gravel, sand, compost, sawdust, wood chips, and de-icing salt) as well as areas where liquids and solids in containers are stored or transferred.
- ▶ While it may be too expensive to cover all industrial activities, cover all high-risk areas first (e.g., chemical preparation areas, vehicle maintenance areas, and areas where salts are stored), then according to budget cover the rest of the materials.
- ▶ Evaluate the strength and longevity of the covering, as well as its compatibility with the material or activity being enclosed.
- ▶ When designing an enclosure, consider access to materials, their handling, and transfer.
- ▶ Materials that pose environmental and safety dangers require special ventilation and temperature considerations.
- ▶ Covering alone may not protect the materials. When designing, consider placing materials on an elevated, impermeable surface or build curbing around the outside of the materials to prevent problems from runoff of uncontaminated stormwater from adjacent areas.
- ▶ Anchor all coverings with stakes, tie-down ropes, large rocks, tires or other easily available heavy objects.

LIMITATIONS:

- ▶ Requires frequent inspection.
- ▶ May pose health or safety problems if enclosure is built over certain activities.

MAINTENANCE:

- ▶ Frequently inspect coverings for rips, holes and general wear.

OBJECTIVES

- Manufacturing
- Material Handling
- Vehicle Maintenance
- Construction
- Commercial Activities
- Roadways
- Waste Containment
- Housekeeping Practices



WEBER COUNTY

ENGINEERING DEPARTMENT

2380 Washington Blvd., Suite 240
Ogden, UT 84401
(801) 399-8374

TARGETED POLLUTANTS

- Sediment
- Nutrients
- Heavy Metals
- Toxic Materials
- Oxygen Demanding Substance
- Oil & Grease
- Floatable Materials
- Bacteria & Viruses
- High Impact
- Medium Impact
- Low or Unknown Impact

IMPLEMENTATION REQUIREMENTS

- Capital Costs
- O&M Costs
- Maintenance
- Training
- High
- Medium
- Low

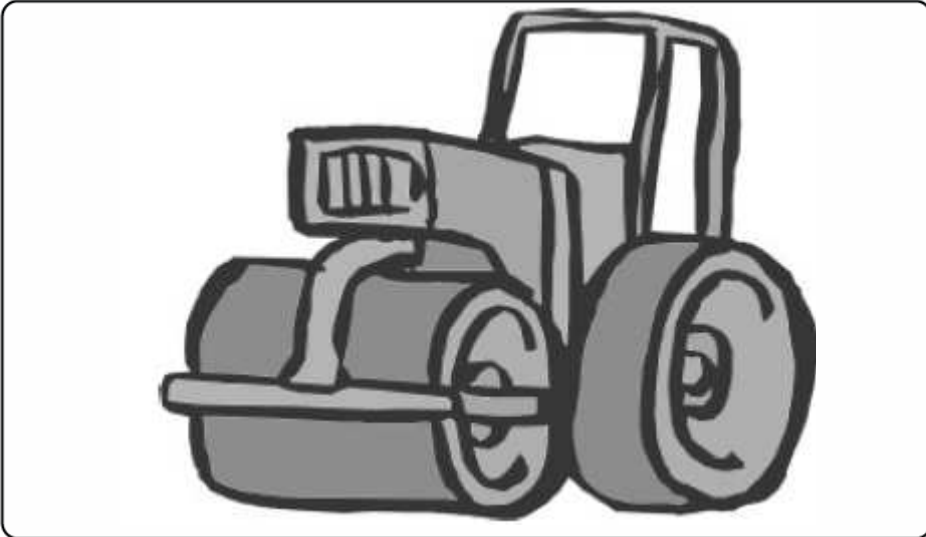

DESCRIPTION:

Use of rolling, tamping, or vibration to stabilize fill materials and control erosion by increasing the soil density. Increasing the density of soil improves soil strength, reduces long-term soil settlement, and provides resistance to erosion.

APPLICATIONS:

- ▶ Stabilize fill material placed around various structures.
- ▶ Improve soil in place as foundation support for roads, parking lots, and buildings.

INSTALLATION/APPLICATION CRITERIA:

- ▶ Make sure soil moisture content is at optimum levels.
- ▶ Use proper compaction equipment.
- ▶ Install sediment control and storm water management devices below compacted areas and runoff interceptor devices above these areas. Drainage from compacted areas must be carefully planned to protect adjacent uncompacted soils.
- ▶ The surface of compacted areas should be scarified and seeded or mulched and seeded to increase the effectiveness of compaction.

LIMITATIONS:

- ▶ Compaction tends to increase runoff.
- ▶ Over-compaction will hamper revegetation efforts.

MAINTENANCE:

- ▶ No maintenance required.

OBJECTIVES

- Housekeeping Practices
- Contain Waste
- Minimize Disturbed Areas
- Stabilize Disturbed Areas
- Protect Slopes/Channels
- Control Site Perimeter
- Control Internal Erosion



WEBER COUNTY

ENGINEERING DEPARTMENT

2380 Washington Blvd., Suite 240
Ogden, UT 84401
(801) 399-8374

TARGETED POLLUTANTS

- Sediment
- Nutrients
- Toxic Materials
- Oil & Grease
- Floatable Materials
- Other Waste

- High Impact
- Medium Impact
- Low or Unknown Impact

IMPLEMENTATION REQUIREMENTS

- Capital Costs
- O&M Costs
- Maintenance
- Training

- High
- Medium
- Low

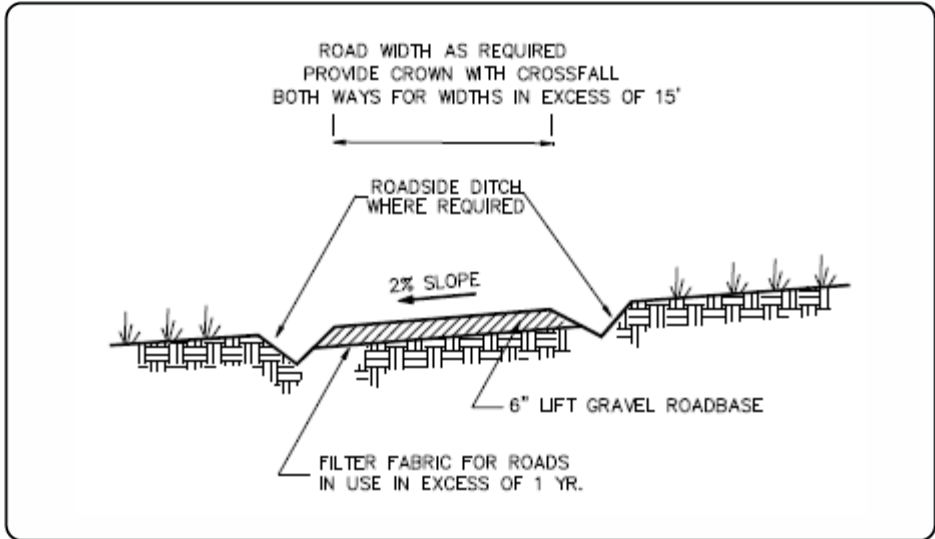

DESCRIPTION:

Temporary stabilization of on-site roadway by placement of gravel roadbase.

APPLICATION:

- ▶ On-site roadways used daily by construction traffic (may not apply to gravelly type soils)
- ▶ Parking or staging areas susceptible to erosion due to traffic use

INSTALLATION/APPLICATION CRITERIA:

- ▶ Grade temporary access road with 2% cross fall, for two-way width provide crown.
- ▶ Provide roadside ditch and outlet controls where required.
- ▶ Place 6 inches of 2-inch to 4-inch crushed rock on driving area

LIMITATIONS:

- ▶ May require removal of gravel roadbase at completion of activities if final cover is not impervious
- ▶ May require controls for surface storm water runoff

MAINTENANCE:

- ▶ Inspect after major rainfall events and at least monthly.
- ▶ Place additional gravel as needed and repair any damaged areas.
- ▶ Maintain any roadside drainage controls.

OBJECTIVES

- Housekeeping Practices
- Contain Waste
- Minimize Disturbed Areas
- Stabilize Disturbed Areas
- Protect Slopes/Channels
- Control Site Perimeter
- Control Internal Erosion



WEBER COUNTY

ENGINEERING DEPARTMENT

2380 Washington Blvd., Suite 240
Ogden, UT 84401
(801) 399-8374

TARGETED POLLUTANTS

- Sediment
- Nutrients
- Toxic Materials
- Oil & Grease
- Floatable Materials
- Other Waste

- High Impact
- Medium Impact
- Low or Unknown Impact

IMPLEMENTATION REQUIREMENTS

- Capital Costs
- O&M Costs
- Maintenance
- Training

- High
- Medium
- Low

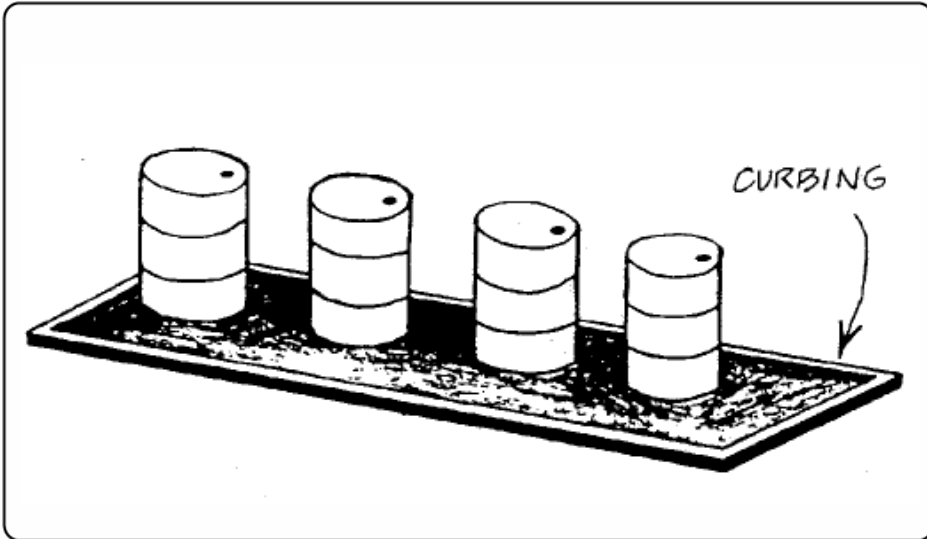

DESCRIPTION:

Curbing is a barrier that surrounds an area of concern, much like containment diking (See Containment Diking BMP). Curbing prevents spills, leaks, etc. from being released to the environment by routing runoff to treatment or control areas. The terms curbing and diking are sometimes used interchangeably.

APPROACH:

- ▶ Curbing can be used at all industrial facilities. It is particularly useful in areas where liquid materials are transferred and as a stormwater runoff control.
- ▶ As with diking, common materials for curbing include earth, concrete, synthetic materials, metal, or other impenetrable materials. Asphalt is also a common material used in curbing.
- ▶ For maximum efficiency, spilled materials should be removed immediately, to allow space for future spills.
- ▶ Curbs should have pumping systems, instead of drainage systems, for collecting spilled materials.
- ▶ Curb systems should be maintained through curb repair (patching and replacement).
- ▶ To minimize the amount of spilled material tracked outside of the area by personnel, grade within the curbing to direct the spilled materials to a downslope side of the curbing, thus keeping the spilled materials away from personnel and equipment. Grading will also facilitate clean-up.

LIMITATIONS:

- ▶ Curbing is not effective for holding large spills.
- ▶ May require more maintenance than diking.

MAINTENANCE:

- ▶ Inspection should be conducted before and after storm events.
- ▶ When certain spills occur, cleanup should start immediately, thus preventing overflows and contamination of stormwater runoff.
- ▶ Inspection should also be made to clear clogging debris, prevent dilution by rainwater, and to again prevent overflow of any materials.

OBJECTIVES

- Manufacturing
- Material Handling
- Vehicle Maintenance
- Construction
- Commercial Activities
- Roadways
- Waste Containment
- Housekeeping Practices



WEBER COUNTY

ENGINEERING DEPARTMENT

2380 Washington Blvd., Suite 240
Ogden, UT 84401
(801) 399-8374

TARGETED POLLUTANTS

- Sediment
- Nutrients
- Heavy Metals
- Toxic Materials
- Oxygen Demanding Substance
- Oil & Grease
- Floatable Materials
- Bacteria & Viruses
- High Impact
- Medium Impact
- Low or Unknown Impact

IMPLEMENTATION REQUIREMENTS

- Capital Costs
- O&M Costs
- Maintenance
- Training
- High
- Medium
- Low

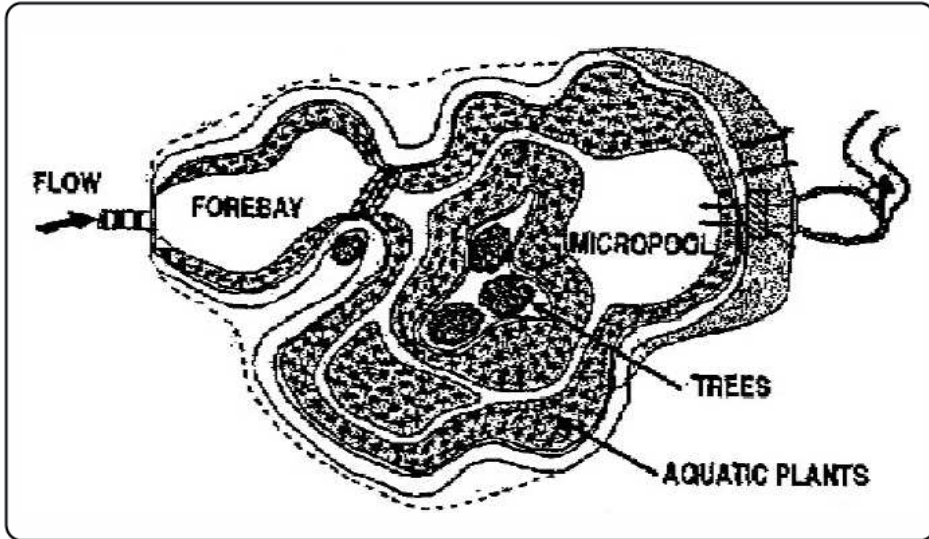

DESCRIPTION:

Constructed wetlands have a significant percentage of the facility covered by wetland vegetation.

APPLICATION:

- ▶ Need to achieve high level of particulate and some dissolved contaminant removal.
- ▶ Ideal for large, regional tributary areas.
- ▶ Multiple benefits of passive recreation and wildlife.

INSTALLATION/APPLICATION CRITERIA:

- ▶ Suitable soils for wetland vegetation are required.
- ▶ Surface area equal to at least 1% and preferably 2% of the tributary watershed.
- ▶ Include a forebay for extra storage and to trap incoming sediment.
- ▶ Involve qualified wetland ecologist to design and install wetland vegetation.
- ▶ Establishing wetland vegetation may be difficult.

LIMITATIONS:

- ▶ Concern for mosquitoes.
- ▶ Cannot be placed on steep unstable slopes.
- ▶ Need base flow to maintain water level.
- ▶ Not feasible in densely developed areas.
- ▶ Nutrient release may occur during winter.
- ▶ Overgrowth can lead to reduced hydraulic capacity.
- ▶ Regulatory agencies may limit water quality to constructed wetlands.

MAINTENANCE:

- ▶ Remove foreign debris and sediment build-up.
- ▶ Areas of bank erosion should be repaired.
- ▶ Remove nuisance species.
- ▶ Control mosquitoes.

CONSIDERATIONS

- Soils
- Area Required
- Slope
- Water Availability
- Aesthetics
- Hydraulic Head
- Environmental Side Effects



WEBER COUNTY

ENGINEERING DEPARTMENT

2380 Washington Blvd., Suite 240
Ogden, UT 84401
(801) 399-8374

TARGETED POLLUTANTS

- Sediment
- Nutrients
- Heavy Metals
- Toxic Materials
- Oxygen Demanding Substance
- Oil & Grease
- Floatable Materials
- Bacteria & Viruses
- High Impact
- Medium Impact
- Low or Unknown Impact

IMPLEMENTATION REQUIREMENTS

- Capital Costs
- O&M Costs
- Maintenance
- Training
- High
- Medium
- Low

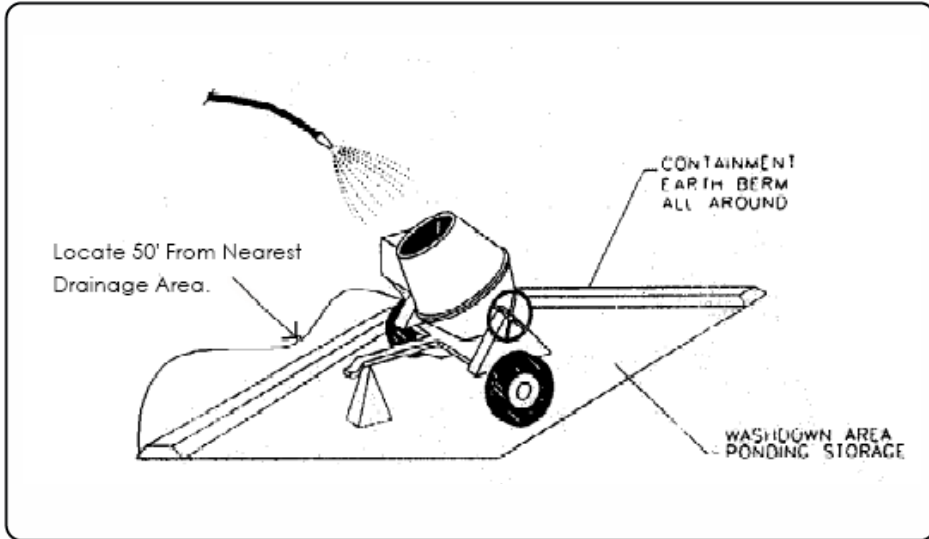

DESCRIPTION:

Prevent or reduce the discharge of pollutants to storm water from concrete waste by conducting washout off-site, performing on-site washout in a designated area, and training employees and subcontractors.

APPLICATIONS:

- ▶ This technique is applicable to all types of sites.

INSTALLATION/APPLICATION CRITERIA:

- ▶ Store dry and wet materials under cover, away from drainage areas.
- ▶ Avoid mixing excess amounts of fresh concrete or cement on-site.
- ▶ Perform washout of concrete trucks off-site or in designated areas only.
- ▶ Do not wash out concrete trucks into storm drains, open ditches, streets, or streams.
- ▶ Do not allow excess concrete to be dumped on-site, except in designated areas.
- ▶ When washing concrete to remove fine particles and expose the aggregate, avoid creating runoff by draining the water within a bermed or level area. (See Earth Berm Barrier information sheet.)
- ▶ Train employees and subcontractors in proper concrete waste management.

LIMITATIONS:

- ▶ Off-site washout of concrete wastes may not always be possible.

MAINTENANCE:

- ▶ Inspect subcontractors to ensure that concrete wastes are being properly managed.
- ▶ If using a temporary pit, dispose hardened concrete on a regular basis.

OBJECTIVES

- Housekeeping Practices
- Contain Waste
- Minimize Disturbed Areas
- Stabilize Disturbed Areas
- Protect Slopes/Channels
- Control Site Perimeter
- Control Internal Erosion



WEBER COUNTY

ENGINEERING DEPARTMENT

2380 Washington Blvd., Suite 240
Ogden, UT 84401
(801) 399-8374

TARGETED POLLUTANTS

- Sediment
- Nutrients
- Toxic Materials
- Oil & Grease
- Floatable Materials
- Other Construction Waste

- High Impact
- Medium Impact
- Low or Unknown Impact

IMPLEMENTATION REQUIREMENTS

- Capital Costs
- O&M Costs
- Maintenance
- Training

- High
- Medium
- Low

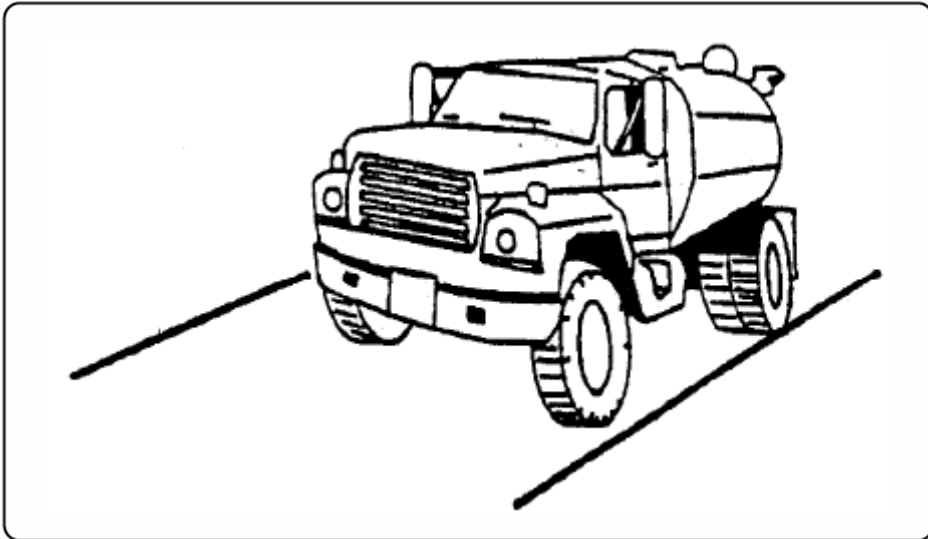

DESCRIPTION:

Dust control measures are used to stabilize soil from wind erosion, and reduce dust by construction activities.

APPLICATION:

- ▶ Dust control is useful in any process area, loading and unloading area, material handling areas, and transfer areas where dust is generated. Street sweeping is limited to areas that are paved.

INSTALLATION/APPLICATION CRITERIA:

- ▶ Mechanical dust collection systems are designed according to the size of dust particles and the amount of air to be processed. Manufacturers' recommendations should be followed for installation (as well as the design of the equipment).
- ▶ Two kinds of street sweepers are common: brush and vacuum. Vacuum sweepers are more efficient and work best when the area is dry.
- ▶ Mechanical equipment should be operated according to the manufacturers' recommendations and should be inspected regularly.

LIMITATIONS:

- ▶ Is generally more expensive than manual systems.
- ▶ May be impossible to maintain by plant personnel (the more elaborate equipment).
- ▶ Is labor and equipment intensive and may not be effective for all pollutants (street sweepers).

MAINTENANCE:

- ▶ If water sprayers are used, dust-contaminated waters should be collected and taken
- ▶ for treatment. Areas will probably need to be resprayed to keep dust from spreading.

OBJECTIVES

- Housekeeping Practices
- Contain Waste
- Minimize Disturbed Areas
- Stabilize Disturbed Areas
- Protect Slopes/Channels
- Control Site Perimeter
- Control Internal Erosion



WEBER COUNTY

ENGINEERING DEPARTMENT

2380 Washington Blvd., Suite 240
Ogden, UT 84401
(801) 399-8374

TARGETED POLLUTANTS

- Sediment
- Nutrients
- Toxic Materials
- Oil & Grease
- Floatable Materials
- Other Waste

- High Impact
- Medium Impact
- Low or Unknown Impact

IMPLEMENTATION REQUIREMENTS

- Capital Costs
- O&M Costs
- Maintenance
- Training

- High
- Medium
- Low

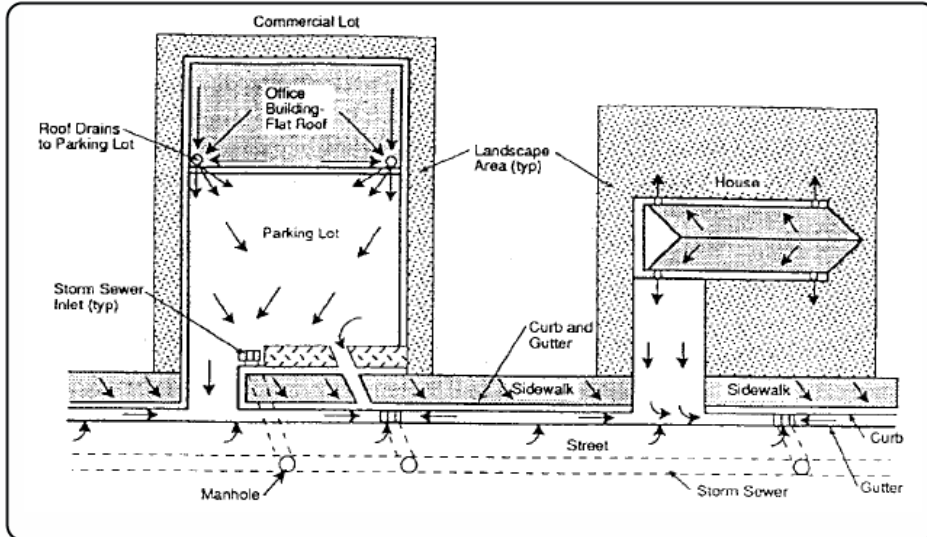

CONSIDERATIONS

- Soils
- Area Required
- Slope
- Water Availability
- Aesthetics
- Hydraulic Head
- Environmental Side Effects



WEBER COUNTY

ENGINEERING DEPARTMENT

2380 Washington Blvd., Suite 240
Ogden, UT 84401
(801) 399-8374

DESCRIPTION:

Minimizing directly connected impervious areas (DCIAs) is a structural BMP strategy that requires a basic change in drainage design philosophy. The basic principle is to direct stormwater runoff to landscaped areas, grass buffer strips, and vegetated swales to slow down the rate of runoff, reduce runoff volumes, attenuate peak flows, and encourage filtering and infiltration of stormwater.

APPLICATIONS:

- ▶ It can be made an integral part of drainage planning for any development.

INSTALLATION/APPLICATION CRITERIA:

- ▶ Use on sites with general terrain slopes flatter than 3-4%.
- ▶ Design the site drainage flow path to maximize flow over vegetated areas before leaving a site.
- ▶ Minimize ground slopes to limit erosion and slow down water flow.
- ▶ Select vegetation that will not only survive, but also enhance water quality.

LIMITATIONS:

- ▶ Potential increase in site open space requirements over the traditional development systems.
- ▶ Introduction of a non-conventional development design strategy.
- ▶ Infiltration of water near building foundations and parking lots is a concern.
- ▶ Will likely result in increased maintenance along the swales.

MAINTENANCE:

- ▶ Maintain grass and other vegetation.
- ▶ Pick up debris.
- ▶ Conduct ongoing inspections for potential erosion problems and changes in drainage patterns.
- ▶ Remove sediment buildup and replace damaged grass cover.

TARGETED POLLUTANTS

- Sediment
- Nutrients
- Heavy Metals
- Toxic Materials
- Oxygen Demanding Substance
- Oil & Grease
- Floatable Materials
- Bacteria & Viruses
- High Impact
- Medium Impact
- Low or Unknown Impact

IMPLEMENTATION REQUIREMENTS

- Capital Costs
- O&M Costs
- Maintenance
- Training
- High
- Medium
- Low

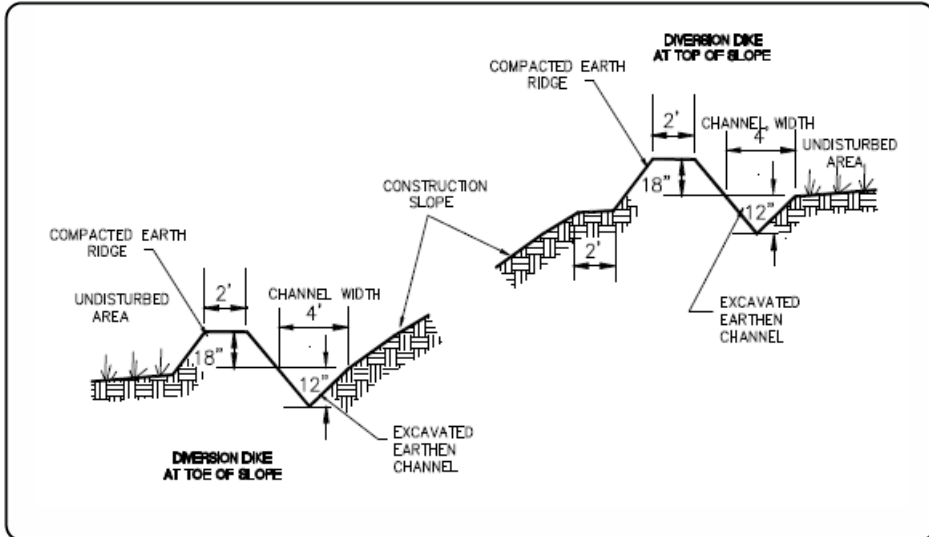

- ### OBJECTIVES
- Housekeeping Practices
 - Contain Waste
 - Minimize Disturbed Areas
 - Stabilize Disturbed Areas
 - Protect Slopes/Channels
 - Control Site Perimeter
 - Control Internal Erosion



WEBER COUNTY

ENGINEERING DEPARTMENT
 2380 Washington Blvd., Suite 240
 Ogden, UT 84401
 (801) 399-8374

DESCRIPTION:

A temporary sediment barrier and storm runoff conveyance consisting of an excavation channel and compacted earth ridge.

APPLICATION:

- ▶ Construct along top of construction slope to intercept upgradient runoff and convey around construction site.
- ▶ Construct along toe of construction to divert sediment laden runoff.
- ▶ Construct along midpoint of construction slope to intercept runoff and channel to controlled discharge point.
- ▶ Construct around base of soil stockpiles to capture sediment.
- ▶ Construct around perimeter of disturbed areas to capture sediment.

INSTALLATION/APPLICATION CRITERIA:

- ▶ Clear and grub area for dike construction.
- ▶ Excavate channel and place soil on downgradient side.
- ▶ Shape and machine compact excavated soil to form ridge.
- ▶ Place erosion protection (riprap, mulch) at outlet.
- ▶ Stabilize channel and ridge as required with mulch, gravel, or vegetative cover.

LIMITATIONS:

- ▶ Recommended maximum drainage area of 5 acres
- ▶ Recommended maximum sideslopes of 2h:1v (50%)
- ▶ Recommended maximum slope on channel of 1%

MAINTENANCE:

- ▶ Inspect immediately after any rainfall and at least daily during prolonged rainfall.
- ▶ Look for runoff breaching dike or eroding channel or sideslopes.
- ▶ Check discharge point for erosion or bypassing of flows.
- ▶ Repair and stabilize as necessary.
- ▶ Inspect daily during vehicular activity on slope, check for and repair any traffic damage.

- ### TARGETED POLLUTANTS
- Sediment
 - Nutrients
 - Toxic Materials
 - Oil & Grease
 - Floatable Materials
 - Other Waste
-
- High Impact
 - Medium Impact
 - Low or Unknown Impact

- ### IMPLEMENTATION REQUIREMENTS
- Capital Costs
 - O&M Costs
 - Maintenance
 - Training
-
- High
 - Medium
 - Low

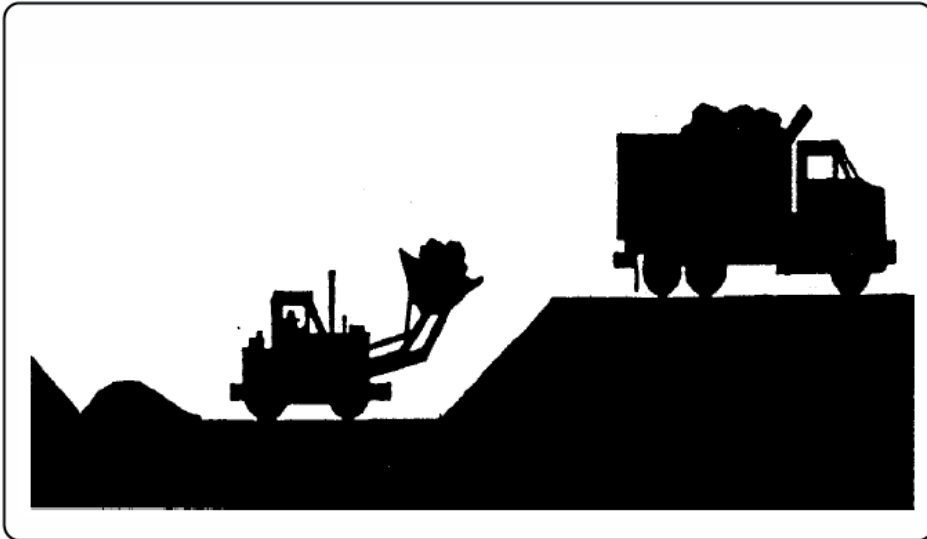

DESCRIPTION:

Proper maintenance and silt removal is required on both a routine and corrective basis to promote effective stormwater pollutant removal efficiencies for wet/dry detention pond and infiltrative devices.

APPROACH:

- ▶ Remove silt after sufficient accumulation.
- ▶ Periodically clean accumulated sediment and silt out of pre-treatment inlets.
- ▶ Infiltration device silt removal should occur when the infiltration rate drops below ½ inch per hour.
- ▶ Removal of accumulated paper, trash, and debris should occur every six months or as needed to prevent clogging of control devices.
- ▶ Vegetation growth should not be allowed to exceed 18 inches in height.
- ▶ Mow the slopes periodically and check for clogging, erosion and tree growth on the embankment.
- ▶ Corrective maintenance may require more frequent attention (as required).
- ▶ Create a public education campaign to explain the function of wet/dry detention pond/infiltration devices and their operation requirements for proper effectiveness.
- ▶ Encourage the public to report wet/dry detention pond/infiltration devices needing maintenance.

LIMITATIONS:

- ▶ Wet detention pond dredging can produce slurried waste that often exceeds the requirements of many landfills.
- ▶ Frequent sediment removal is labor and cost intensive.

OBJECTIVES

- New Development
- Residential
- Commercial Activities
- Industrial Activities
- Municipal Facilities
- Illegal Discharges



WEBER COUNTY

ENGINEERING DEPARTMENT

2380 Washington Blvd., Suite 240
Ogden, UT 84401
(801) 399-8374

TARGETED POLLUTANTS

- Sediment
- Nutrients
- Heavy Metals
- Toxic Materials
- Oxygen Demanding Substance
- Oil & Grease
- Floatable Materials
- Bacteria & Viruses
- High Impact
- Medium Impact
- Low or Unknown Impact

IMPLEMENTATION REQUIREMENTS

- Capital Costs
- O&M Costs
- Regulatory
- Training
- Staffing
- Administrative
- High
- Medium
- Low

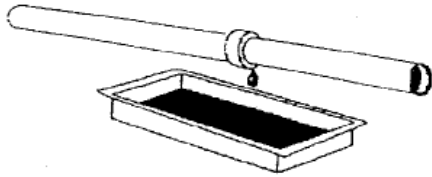

Use Drip Pans for Leaking Equipment

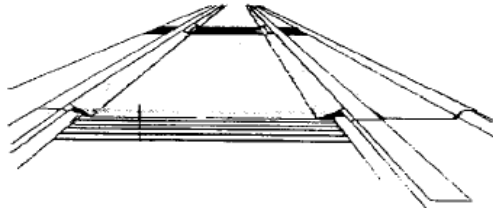

Use Drip Pans in Loading and Unloading Areas

DESCRIPTION:

Drip pans are small depressions or pans used to contain very small volumes of leaks, drips, and spills that occur at a facility. Drip pans can be depressions in concrete, asphalt, or other impenetrable material. They can be made of metal, plastic, or any material that does not react with the dripped chemicals. Drip pans can be temporary or permanent.

Drip pans are used to catch drips from valves, pipes, etc. so that the materials or chemicals can be cleaned up easily or recycled before they contaminate stormwater. Although leaks and drips should be repaired and eliminated as part of a preventative maintenance program, drip pans can provide a temporary solution where repair or replacement must be delayed. In addition, drip pans can be an added safeguard when they are positioned beneath areas where leaks and drips may occur.

APPROACH:

- ▶ When using drip pans, consider the location of the drip pan, weather conditions, the type of material used for the drip pan, and how it will be cleaned.
- ▶ The location of the drip pan is important. Because drip pans must be inspected and cleaned frequently, they must be easy to reach and remove. However, take special care to avoid placing drip pans where they can be easily overturned or be a safety hazard.
- ▶ Secure pans by installing or anchoring them. Drip pans may be placed on platforms, behind wind blocks or tied down.
- ▶ Employees must pay attention to the pans and empty them when they are nearly full.
- ▶ Frequent inspection of the drip pans is necessary due to the possibility of leaks in the pan itself or in piping or valves that may occur randomly or irregular slow drips that may increase in volume.

LIMITATIONS:

- ▶ Contain small volumes only.
- ▶ Must be inspected and cleaned frequently.
- ▶ Must be secured during poor weather conditions.
- ▶ Contents may be disposed of improperly unless facility personnel are trained in proper disposal methods.

OBJECTIVES

- Manufacturing
- Material Handling
- Vehicle Maintenance
- Construction
- Commercial Activities
- Roadways
- Waste Containment
- Housekeeping Practices



WEBER COUNTY

ENGINEERING DEPARTMENT

2380 Washington Blvd., Suite 240
Ogden, UT 84401
(801) 399-8374

TARGETED POLLUTANTS

- Sediment
- Nutrients
- Heavy Metals
- Toxic Materials
- Oxygen Demanding Substance
- Oil & Grease
- Floatable Materials
- Bacteria & Viruses
- High Impact
- Medium Impact
- Low or Unknown Impact

IMPLEMENTATION REQUIREMENTS

- Capital Costs
- O&M Costs
- Maintenance
- Training
- High
- Medium
- Low

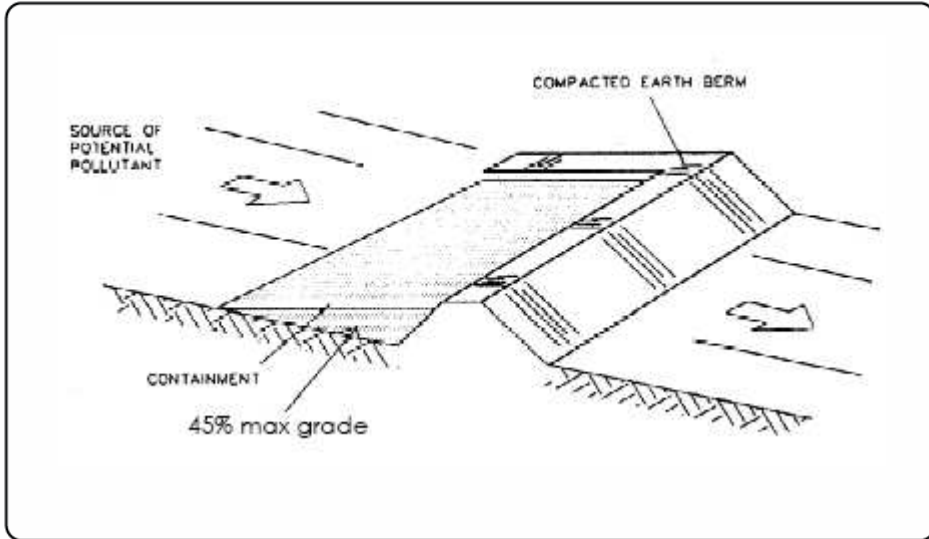

DESCRIPTION:

A temporary containment control constructed of compacted soil.

APPLICATION:

- ▶ Construct around waste and materials storage area.
- ▶ Construct around staging and maintenance areas.
- ▶ Construct around vehicle parking and servicing areas.

INSTALLATION/APPLICATION CRITERIA:

- ▶ Construct an earthen berm down hill of the area to be controlled. The berm should surround fueling facilities and maintenance areas on three sides to provide containment.
- ▶ Berm needs to be a minimum of 1 foot tall by 1 foot wide and be compacted by earth moving equipment.

LIMITATIONS:

- ▶ Not effective on steep slopes.
- ▶ Limits access to controlled area.
- ▶ Personnel need to quickly respond to spills with remedial actions.

MAINTENANCE:

- ▶ Observe daily for any non-stormwater discharge.
- ▶ Look for runoff bypassing ends of berms or undercutting berms.
- ▶ Repair or replace damaged areas of the berm and remove accumulated sediment.
- ▶ Recompile soil around berm as necessary to prevent piping.

OBJECTIVES

- Housekeeping Practices
- Contain Waste
- Minimize Disturbed Areas
- Stabilize Disturbed Areas
- Protect Slopes/Channels
- Control Site Perimeter
- Control Internal Erosion



WEBER COUNTY

ENGINEERING DEPARTMENT

2380 Washington Blvd., Suite 240
Ogden, UT 84401
(801) 399-8374

TARGETED POLLUTANTS

- Sediment
- Nutrients
- Toxic Materials
- Oil & Grease
- Floatable Materials
- Other Construction Waste

- High Impact
- Medium Impact
- Low or Unknown Impact

IMPLEMENTATION REQUIREMENTS

- Capital Costs
- O&M Costs
- Maintenance
- Training

- High
- Medium
- Low

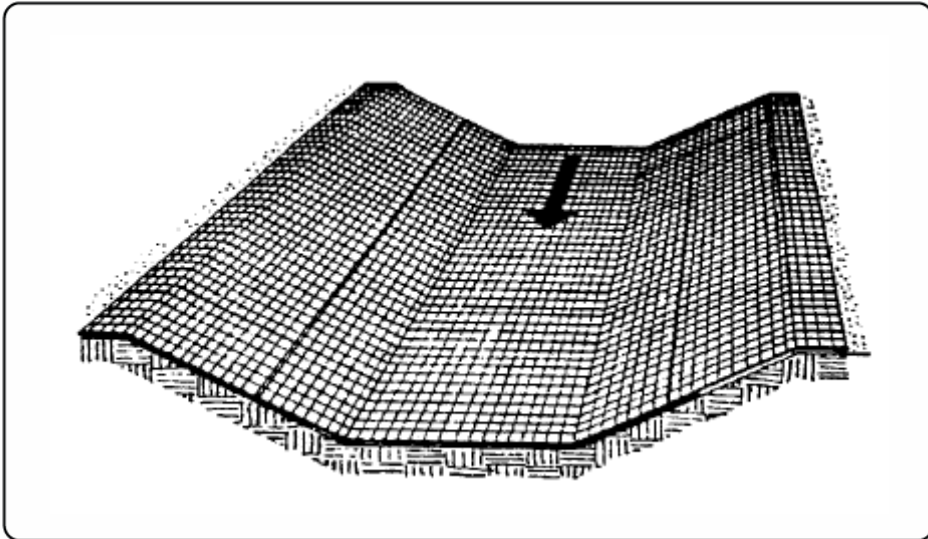

DESCRIPTION:

- ▶ Erosion control blankets are used in place of mulch on areas of high velocity runoff and/or steep grade, to aid in controlling erosion on critical areas by protecting young vegetation.

APPLICATIONS:

- ▶ Where vegetation is likely to grow too slowly to provide adequate cover.
- ▶ In areas subject to high winds where mulch would not be effective.

INSTALLATION/APPLICATION CRITERIA:

- ▶ Install erosion control blankets parallel to the direction of the slope.
- ▶ In ditches, apply in direction of the flow.
- ▶ Place erosion control blankets loosely on soil - do not stretch.
- ▶ Ends of blankets should be buried no less than six inches deep.
- ▶ Staple the edges of the blanket at least every three feet.

LIMITATIONS:

- ▶ Not recommended in areas which are still under construction.

MAINTENANCE:

- ▶ Check for erosion and undermining periodically, particularly after rainstorms.
- ▶ Repair dislocations or failures immediately.
- ▶ If washouts occur, reinstall after repairing slope damage.
- ▶ Monitor until permanently stabilized.

OBJECTIVES

- Housekeeping Practices
- Contain Waste
- Minimize Disturbed Areas
- Stabilize Disturbed Areas
- Protect Slopes/Channels
- Control Site Perimeter
- Control Internal Erosion



WEBER COUNTY

ENGINEERING DEPARTMENT

2380 Washington Blvd., Suite 240
Ogden, UT 84401
(801) 399-8374

TARGETED POLLUTANTS

- Sediment
- Nutrients
- Toxic Materials
- Oil & Grease
- Floatable Materials
- Other Waste

- High Impact
- Medium Impact
- Low or Unknown Impact

IMPLEMENTATION REQUIREMENTS

- Capital Costs
- O&M Costs
- Maintenance
- Training

- High
- Medium
- Low

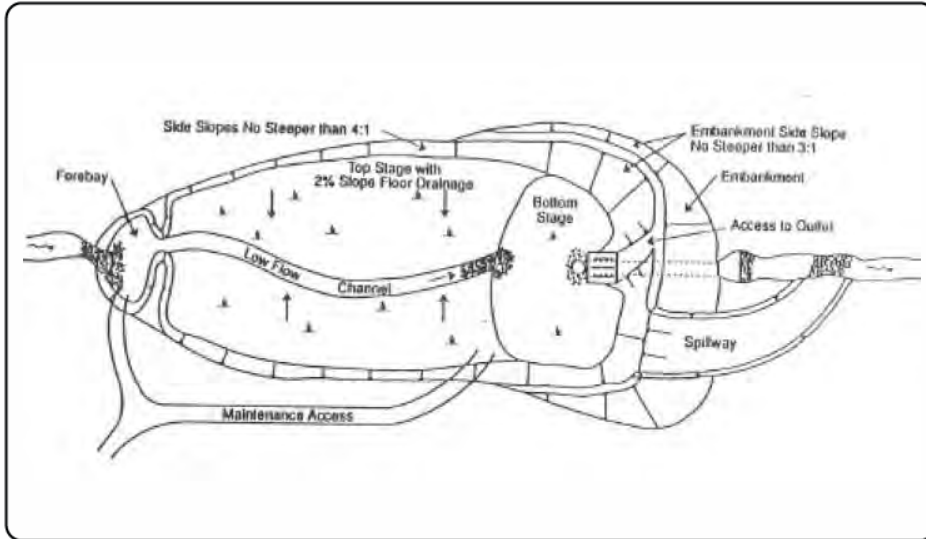

CONSIDERATIONS

- Soils
- Area Required
- Slope
- Water Availability
- Aesthetics
- Hydraulic Head
- Environmental Side Effects



WEBER COUNTY

ENGINEERING DEPARTMENT

2380 Washington Blvd., Suite 240
Ogden, UT 84401
(801) 399-8374

DESCRIPTIONS:

Extended detention basins are dry between storms. During a storm the basin fills. A bottom outlet releases the stormwater slowly to provide time for sediments to settle.

APPLICATION:

- ▶ Objective is to remove only particulate pollutants.
- ▶ Use where lack of water prevents the use of wet ponds, wetlands or biofilters.
- ▶ Use where wet ponds or wetlands would cause unacceptable mosquito conditions.

INSTALLATION/APPLICATION CRITERIA:

- ▶ Basin volume is sized to capture a particular fraction of the runoff.
- ▶ Drawdown time of 24 to 40 hours is required.
- ▶ A shallow basin with large surface area performs better than a deep basin with the same volume.
- ▶ Place energy dissipators at the entrance to minimize bottom erosion and resuspension.
- ▶ Vegetate side slopes and bottom to the maximum extent practical.
- ▶ If side erosion is particularly severe, consider paving or soil stabilization.
- ▶ If floatables are a problem, protect outlet with a trash rack or other device.
- ▶ Provide bypass or pass through capabilities for 100-year storm.

LIMITATIONS:

- ▶ May be less reliable than other treatment control BMPs. Inability to vegetate banks and bottom may result in erosion and resuspension.
- ▶ Limitation of the orifice diameter may preclude use in small watersheds.
- ▶ Requires differential elevation between inlet and outlet.

MAINTENANCE:

- ▶ Check outlet regularly for clogging.
- ▶ Check banks and bottom of basin for erosion and correct as necessary.
- ▶ Remove sediment when accumulation reaches 6-inches, or if resuspension is observed.

TARGETED POLLUTANTS

- Sediment
- Nutrients
- Heavy Metals
- Toxic Materials
- Oxygen Demanding Substance
- Oil & Grease
- Floatable Materials
- Bacteria & Viruses
- High Impact
- Medium Impact
- Low or Unknown Impact

IMPLEMENTATION REQUIREMENTS

- Capital Costs
- O&M Costs
- Maintenance
- Training
- High
- Medium
- Low



OBJECTIVES

- New Development
- Residential
- Commercial Activities
- Industrial Activities
- Municipal Facilities
- Illegal Discharges

DESCRIPTION:

Employee training, like equipment maintenance, is a method by which to implement BMPs. Employee training should be used in conjunction with all other BMPs as part of the facility's SWPPP.

The specific employee training aspects of each of the source controls are highlighted in the individual information sheets. The focus of this information sheet is more general, and includes the overall objectives and approach for assuring employee training in stormwater pollution prevention. Accordingly, the organization of this information sheet differs somewhat from the other information sheets in this chapter.

OBJECTIVES:

Employee training should be based on four objectives:

- ▶ Promote a clear identification and understanding of the problem, including activities with the potential to pollute stormwater;
- ▶ Identify solutions (BMPs);
- ▶ Promote employee ownership of the problems and the solutions; and
- ▶ Integrate employee feedback into training and BMP implementation.

APPROACH:

- ▶ Integrate training regarding stormwater quality management with existing training programs that may be required for other regulations.
- ▶ Employee training is a vital component of many of the individual source control BMPs included in this manual.



WEBER COUNTY

ENGINEERING DEPARTMENT

2380 Washington Blvd., Suite 240
Ogden, UT 84401
(801) 399-8374

TARGETED POLLUTANTS

- Sediment
- Nutrients
- Heavy Metals
- Toxic Materials
- Oxygen Demanding Substance
- Oil & Grease
- Floatable Materials
- Bacteria & Viruses
- High Impact
- Medium Impact
- Low or Unknown Impact

IMPLEMENTATION REQUIREMENTS

- Capital Costs
- O&M Costs
- Regulatory
- Training
- Staffing
- Administrative
- High
- Medium
- Low

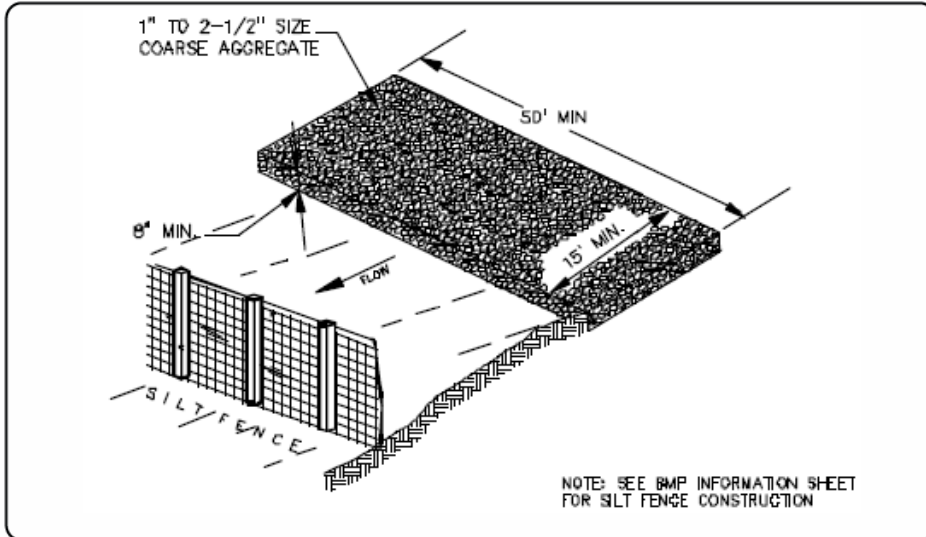

DESCRIPTION:

A stabilized pad of crushed stone for general washing of equipment and construction vehicles.

APPLICATION:

- ▶ At any site where regular washing of vehicles and equipment will occur. May also be used as a filling point for water trucks limiting erosion caused by overflow or spillage of water.

INSTALLATION/APPLICATION CRITERIA:

- ▶ Clear and grub area and grade to provide maximum slope of 1%
- ▶ Compact subgrade and place filter fabric if desired (recommended for wash areas to remain in use for more than 3 months).
- ▶ Place coarse aggregate, 1 to 2-1/2 inches in size, to a minimum depth of 8-inches.
- ▶ Install silt fence downgradient (see silt fence BMP information sheet).

LIMITATIONS:

- ▶ Cannot be utilized for washing equipment or vehicles that may cause contamination of runoff such as fertilizer equipment or concrete equipment. Solely used to control sediment in wash water.

MAINTENANCE:

- ▶ Inspect daily for loss of gravel or sediment buildup.
- ▶ Inspect adjacent area for sediment deposit and install additional controls as necessary.
- ▶ Repair area and replace gravel as required to maintain control in good working condition.
- ▶ Expand stabilized area as required to accommodate activities.
- ▶ Maintain silt fence as outlined in specific silt fence BMP information sheet.

OBJECTIVES

- Housekeeping Practices
- Contain Waste
- Minimize Disturbed Areas
- Stabilize Disturbed Areas
- Protect Slopes/Channels
- Control Site Perimeter
- Control Internal Erosion



WEBER COUNTY

ENGINEERING DEPARTMENT

2380 Washington Blvd., Suite 240
Ogden, UT 84401
(801) 399-8374

TARGETED POLLUTANTS

- Sediment
- Nutrients
- Toxic Materials
- Oil & Grease
- Floatable Materials
- Other Waste

- High Impact
- Medium Impact
- Low or Unknown Impact

IMPLEMENTATION REQUIREMENTS

- Capital Costs
- O&M Costs
- Maintenance
- Training

- High
- Medium
- Low

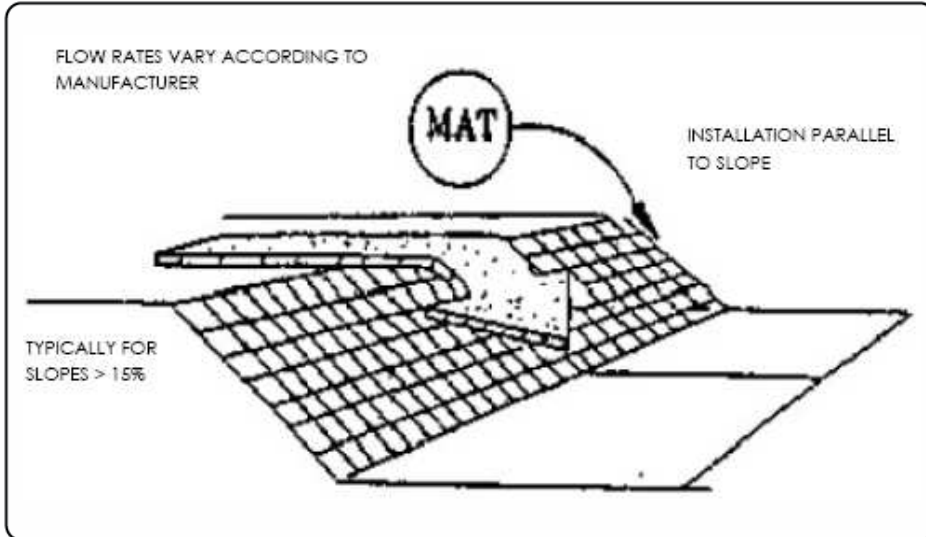

DESCRIPTION:

Mats made of natural or synthetic material, which are used to temporarily or permanently stabilize soil.

APPLICATION:

- ▶ Typically suited for post-construction site stabilization, but may be used for temporary stabilization of highly erosive soils.
- ▶ Channels and streams.
- ▶ Steep slopes.

INSTALLATION/APPLICATION CRITERIA:

- ▶ Mats may be applied to disturbed soils and where existing vegetation has been removed.
- ▶ The following organic matting materials provide temporary protection until permanent vegetation is established, or when seasonal circumstances dictate the need for temporary stabilization until weather or construction delays are resolved: Jute mats and straw mats.
- ▶ The following synthetic mats may be used for either temporary or post-construction stabilization, both with and without vegetation: excelsior matting, glass fiber matting, and mulch matting.
- ▶ Staples are needed to anchor the matting.

LIMITATIONS:

- ▶ Mats are more costly than other BMP practices, limiting their use to areas where other BMPs are ineffective (e.g., channels, steep slopes).
- ▶ May delay seed germination, due to reduction in soil temperature.
- ▶ Installation requires experienced contractor to ensure soil stabilization and erosion protection.

MAINTENANCE:

- ▶ Inspect monthly and after significant rainfall.
- ▶ Re-anchor loosened matting and replace missing matting and staples as required.

OBJECTIVES

- Housekeeping Practices
- Contain Waste
- Minimize Disturbed Areas
- Stabilize Disturbed Areas
- Protect Slopes/Channels
- Control Site Perimeter
- Control Internal Erosion



WEBER COUNTY

ENGINEERING DEPARTMENT

2380 Washington Blvd., Suite 240
Ogden, UT 84401
(801) 399-8374

TARGETED POLLUTANTS

- Sediment
- Nutrients
- Toxic Materials
- Oil & Grease
- Floatable Materials
- Other Waste

- High Impact
- Medium Impact
- Low or Unknown Impact

IMPLEMENTATION REQUIREMENTS

- Capital Costs
- O&M Costs
- Maintenance
- Training

- High
- Medium
- Low



DESCRIPTION:

A combination of wood fiber mulch, processed grass, or hay or straw mulch and a tacking agent. It is made into slurry, and then applied to bare slopes or other bare areas to provide temporary stabilization.

APPLICATIONS:

- ▶ Small roadside slopes.
- ▶ Large, relatively flat areas.

INSTALLATION/APPLICATION CRITERIA:

- ▶ Legume seeds should be pellet inoculated with the appropriate bacteria.
- ▶ The seed should not remain in the hydromulcher tank for more than 30 minutes.
- ▶ Wood fiber may be dyed to aid in uniform application.
- ▶ Slurry should be uniformly applied until an adequate coverage is achieved.
- ▶ The applicator should not be directed at one location for a long period of time; erosion will occur.

LIMITATIONS:

- ▶ Will lose effectiveness after 1 year.
- ▶ Can use only on physically stable slopes (at natural angle of repose, or less).

MAINTENANCE:

- ▶ Periodically inspect for damage caused by wind, water, or human disturbance.
- ▶ Promptly repair damaged areas.

OBJECTIVES

- Housekeeping Practices
- Contain Waste
- Minimize Disturbed Areas
- Stabilize Disturbed Areas
- Protect Slopes/Channels
- Control Site Perimeter
- Control Internal Erosion



WEBER COUNTY

ENGINEERING DEPARTMENT

2380 Washington Blvd., Suite 240
Ogden, UT 84401
(801) 399-8374

TARGETED POLLUTANTS

- Sediment
- Nutrients
- Toxic Materials
- Oil & Grease
- Floatable Materials
- Other Waste

- High Impact
- Medium Impact
- Low or Unknown Impact

IMPLEMENTATION REQUIREMENTS

- Capital Costs
- O&M Costs
- Maintenance
- Training

- High
- Medium
- Low



OBJECTIVES

- New Development
- Residential
- Commercial Activities
- Industrial Activities
- Municipal Facilities
- Illegal Discharges



WEBER COUNTY

ENGINEERING DEPARTMENT

2380 Washington Blvd., Suite 240
Ogden, UT 84401
(801) 399-8374

DESCRIPTION:

Promote efficient and safe housekeeping practices (storage, use, and cleanup) when handling potentially harmful materials such as fertilizers, pesticides, cleaning solutions, paint products, automotive products, and swimming pool chemicals.

APPROACH:

- ▶ Pattern a new program after the many established programs from municipalities around the country. Integrate this best management practice as much as possible with existing programs at your municipality.
- ▶ This BMP has two key audiences: municipal employees and the general public.
- ▶ For the general public, municipalities should establish a public education program that provides information on such items as storm water pollution and beneficial effects of proper disposal on water quality; reading product labels; safer alternative products; safe storage, handling, and disposal of hazardous products; list of local agencies; and emergency phone numbers. The programs listed below have provided this information through brochures or booklets that are available at a variety of locations including municipal offices, household hazardous waste collection events or facilities, and public information fairs.

Municipal facilities should develop controls on the application of pesticides, herbicides, and fertilizers in public right-of-ways and at municipal facilities.

Controls may include:

- ▶ List of approved pesticides and selected uses.
- ▶ Product and application information for users.
- ▶ Equipment use and maintenance procedures.
- ▶ Record keeping and public notice procedures.

LIMITATIONS:

- ▶ There are no major limitations to this best management practice.

TARGETED POLLUTANTS

- Sediment
- Nutrients
- Heavy Metals
- Toxic Materials
- Oxygen Demanding Substance
- Oil & Grease
- Floatable Materials
- Bacteria & Viruses
- High Impact
- Medium Impact
- Low or Unknown Impact

IMPLEMENTATION REQUIREMENTS

- Capital Costs
- O&M Costs
- Regulatory
- Training
- Staffing
- Administrative
- High
- Medium
- Low



OBJECTIVES

- New Development
- Residential
- Commercial Activities
- Industrial Activities
- Municipal Facilities
- Illegal Discharges

DESCRIPTION:

Prevent or reduce the discharge of pollutants to stormwater from hazardous waste through proper material use, waste disposal, and training of employees and subcontractors.

APPLICATION:

Many of the chemicals used on-site can be hazardous materials which become hazardous waste upon disposal. These wastes may include:

- ▶ Paints and solvents; petroleum products such as oils; fuels and greases; herbicides and pesticides; acids for cleaning masonry; and concrete curing compounds.

In addition, sites with existing structures may contain wastes which must be disposed of in accordance with federal, state and local regulations, including:

- ▶ Sandblasting grit mixed with lead, cadmium or chromium based paints, asbestos, and PCBs.

INSTALLATION/APPLICATION CRITERIA:

The following steps will help reduce stormwater pollution from hazardous wastes:

- ▶ Use the entire product before disposing of the container.
- ▶ Do not remove the original product label; it contains important safety and disposal information.
- ▶ Do not over-apply herbicides and pesticides. Prepare only the amount needed. Follow the recommended usage instructions. Over-application is expensive and environmentally harmful. Apply surface dressings in several smaller applications, as opposed to one large application, to allow time for infiltration and to avoid excess material being carried off-site by runoff. Do not apply these chemicals just before it rains. People applying pesticides must be certified in accordance with federal and state regulations.

LIMITATIONS:

- ▶ Hazardous waste that cannot be reused or recycled must be disposed of by a licensed hazardous waste collector.

MAINTENANCE:

- ▶ Inspect hazardous waste receptacles and areas regularly.
- ▶ Arrange for regular hazardous waste collection.



WEBER COUNTY

ENGINEERING DEPARTMENT

2380 Washington Blvd., Suite 240
Ogden, UT 84401
(801) 399-8374

TARGETED POLLUTANTS

- Sediment
- Nutrients
- Heavy Metals
- Toxic Materials
- Oxygen Demanding Substance
- Oil & Grease
- Floatable Materials
- Bacteria & Viruses
- High Impact
- Medium Impact
- Low or Unknown Impact

IMPLEMENTATION REQUIREMENTS

- Capital Costs
- O&M Costs
- Regulatory
- Training
- Staffing
- Administrative
- High
- Medium
- Low

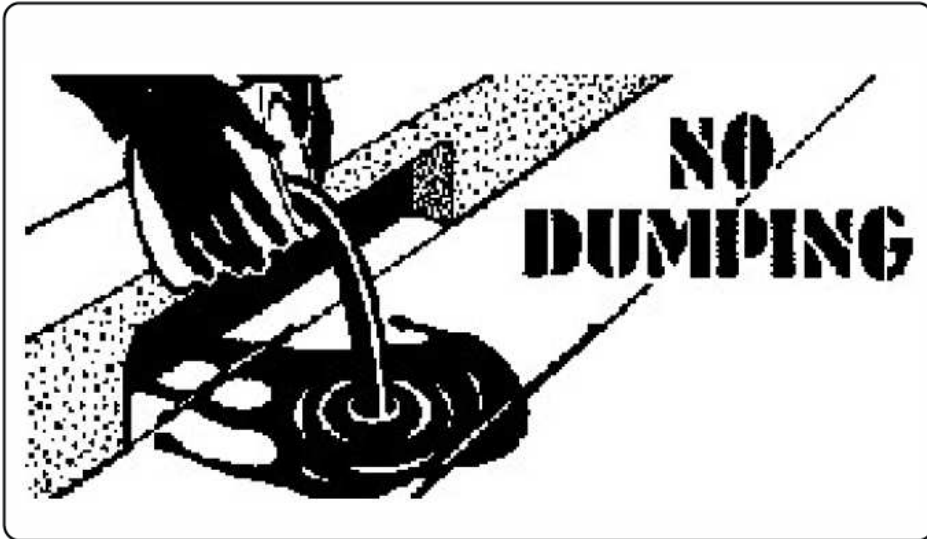

DESCRIPTION:

Implement measures to detect, correct, and enforce against illegal dumping of pollutants on streets, into the storm drain system, and into creeks. Substances illegally dumped on streets, into the storm drain system, and into creeks include paints, used oil and other automotive fluids, construction debris, chemicals, fresh concrete, leaves, grass clippings, and pet wastes. All of these wastes can cause storm water and receiving water quality problems as well as clog the storm drain system.

APPROACH:

One of the keys to success is increasing the general public's awareness of the problem and to at least identify the incident, if not correct it. There are a number of ways of accomplishing this:

- ▶ Train municipal staff from all departments to recognize and report incidents.
- ▶ Deputize municipal staff that may come into contact with illegal dumping with the authority to write illegal dumping tickets for offenders caught in the act.
- ▶ Educate the public.
- ▶ Provide the public with a mechanism for reporting such as a hot line.

Establish system for tracking incidents which will identify:

- ▶ Illegal dumping "hot spots",
- ▶ Types and quantities (in some cases) of wastes,
- ▶ Patterns in time of occurrence (time of day/night, month, or year),
- ▶ Mode of dumping (abandoned containers, "midnight dumping" from moving vehicles, direct dumping of materials, accident/spills), and
- ▶ Responsible parties.

A tracking system also helps manage the program by indicating trends, and identifying who, what, when, and where efforts should be concentrated.

LIMITATIONS

- ▶ The elimination of illegal dumping is dependent on the availability, convenience, and cost of alternative means of disposal.

OBJECTIVES

- New Development
- Residential
- Commercial Activities
- Industrial Activities
- Municipal Facilities
- Illegal Discharges



WEBER COUNTY

ENGINEERING DEPARTMENT

2380 Washington Blvd., Suite 240
Ogden, UT 84401
(801) 399-8374

TARGETED POLLUTANTS

- Sediment
- Nutrients
- Heavy Metals
- Toxic Materials
- Oxygen Demanding Substance
- Oil & Grease
- Floatable Materials
- Bacteria & Viruses

- High Impact
- Medium Impact
- Low or Unknown Impact

IMPLEMENTATION REQUIREMENTS

- Capital Costs
- O&M Costs
- Regulatory
- Training
- Staffing
- Administrative

- High
- Medium
- Low

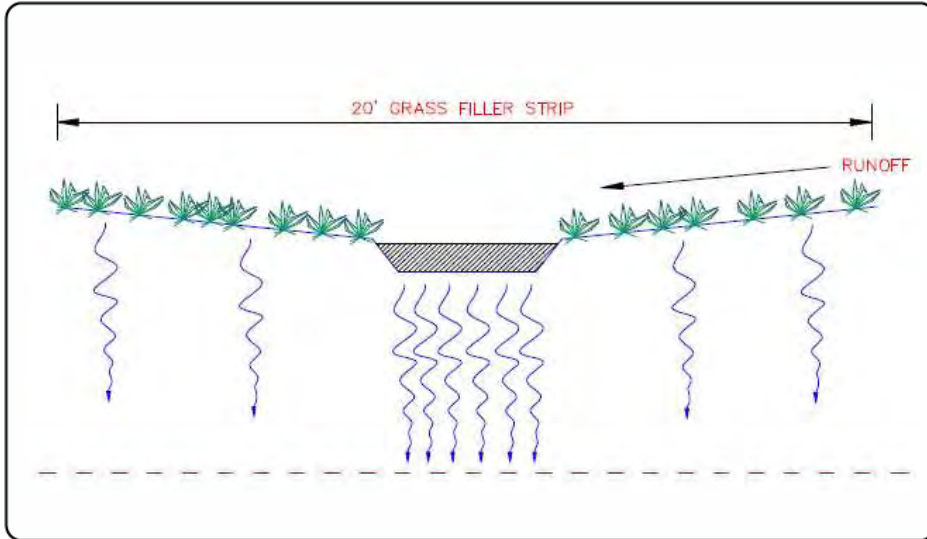

DESCRIPTION:

A family of systems in which the majority of the runoff from small storms is infiltrated into the ground rather than discharged to a surface water body. Infiltration systems include: ponds, vaults, trenches, dry wells, porous pavement, and concrete grids.

APPLICATION:

- ▶ Suitable site soils and geologic conditions; low potential for long-term erosion in the watershed.

INSTALLATION/APPLICATION CRITERIA:

- ▶ Volume sized to capture a particular fraction of annual runoff.
- ▶ Pretreatment is necessary in fine soils.
- ▶ Emergency overflow or bypass for larger storms is needed.
- ▶ Observation wells are required in trenches.
- ▶ Infiltration surface must be protected during construction.
- ▶ Pond sides need vegetation to prevent erosion.
- ▶ During construction frequent inspection for clogging is necessary.
- ▶ Line sides of trench with permeable filter fabric
- ▶ Trench should be filled with clean washed stone or gravel. (1.5-3.0 in.)
- ▶ A six inch sand filter layer; cloth lines the bottom of trench.

LIMITATIONS:

- ▶ Loss of infiltrative capacity and high maintenance cost in fine soils.
- ▶ Low removal of dissolved pollutants in very coarse soils.
- ▶ Not suitable on fill sites or steep slopes.
- ▶ The risk of ground water contamination in very coarse soils, may require ground water monitoring.

MAINTENANCE:

- ▶ Remove sediment at a frequency appropriate to avoid excessive concentrations of pollutants and loss of infiltrative capacity.
- ▶ Frequent cleaning of porous pavements is required.
- ▶ Maintenance is difficult and costly for underground trenches.

CONSIDERATIONS

- Soils
- Area Required
- Slope
- Water Availability
- Aesthetics
- Hydraulic Head
- Environmental Side Effects



WEBER COUNTY

ENGINEERING DEPARTMENT

2380 Washington Blvd., Suite 240
Ogden, UT 84401
(801) 399-8374

TARGETED POLLUTANTS

- Sediment
- Nutrients
- Heavy Metals
- Toxic Materials
- Oxygen Demanding Substance
- Oil & Grease
- Floatable Materials
- Bacteria & Viruses
- High Impact
- Medium Impact
- Low or Unknown Impact

IMPLEMENTATION REQUIREMENTS

- Capital Costs
- O&M Costs
- Maintenance
- Training
- High
- Medium
- Low

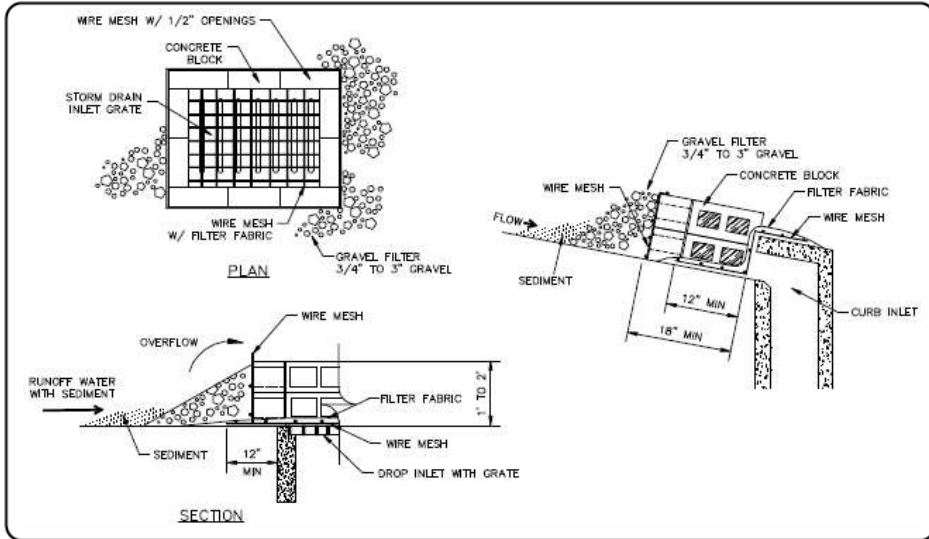

OBJECTIVES

- Housekeeping Practices
- Contain Waste
- Minimize Disturbed Areas
- Stabilize Disturbed Areas
- Protect Slopes/Channels
- Control Site Perimeter
- Control Internal Erosion



WEBER COUNTY

ENGINEERING DEPARTMENT

2380 Washington Blvd., Suite 240
Ogden, UT 84401
(801) 399-8374

DESCRIPTION:

Concrete block and gravel filter placed over inlet to storm drain system.

APPLICATION:

- ▶ Construct at inlets in paved or unpaved areas where upgradient area is to be disturbed by construction activities.

INSTALLATION/APPLICATION CRITERIA:

- ▶ Place wire mesh (with 1/2 inch openings) over the inlet grate extending one foot past the grate in all directions.
- ▶ Place concrete blocks around the inlet with openings facing outward. Stack blocks to minimum height of 12-inches and maximum height of 24-inches.
- ▶ Place wire mesh around outside of blocks.
- ▶ Place gravel (3/4" to 3") around blocks.

LIMITATIONS:

- ▶ Recommended for maximum drainage area of one acre.
- ▶ Excess flows may bypass the inlet requiring down gradient controls.
- ▶ Ponding will occur at inlet.

MAINTENANCE:

- ▶ Inspect inlet protection after every large storm event and at a minimum of once monthly.
- ▶ Remove sediment accumulated when it reaches 4-inches in depth.
- ▶ Replace filter fabric and clean or replace gravel if clogging is apparent.

TARGETED POLLUTANTS

- Sediment
- Nutrients
- Toxic Materials
- Oil & Grease
- Floatable Materials
- Other Waste

- High Impact
- Medium Impact
- Low or Unknown Impact

IMPLEMENTATION REQUIREMENTS

- Capital Costs
- O&M Costs
- Maintenance
- Training

- High
- Medium
- Low

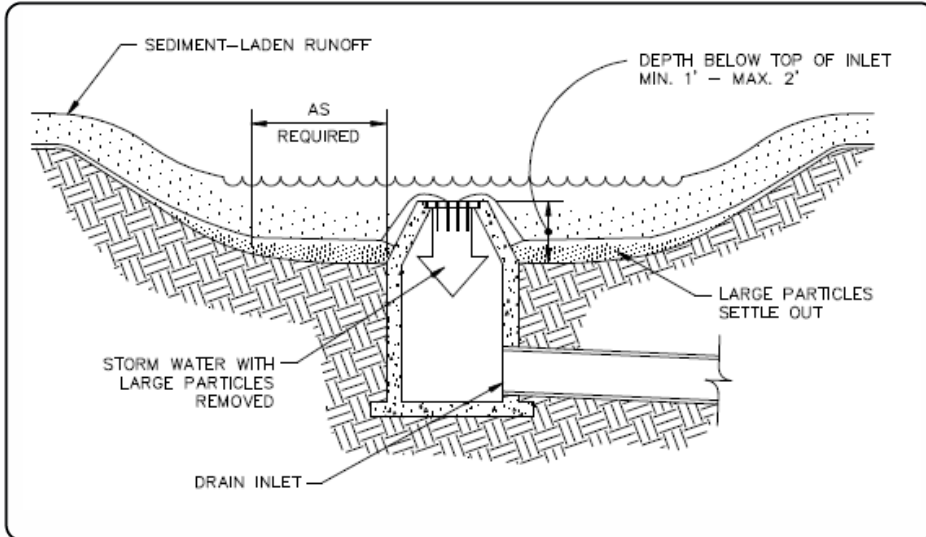

DESCRIPTION:

An area excavated around a storm drain inlet to impound water below the inlet.

APPLICATION:

- ▶ Construct at storm drainage inlets located downgradient of areas to be disturbed by construction (for inlets in paved areas see other information sheets for inlet protection).

INSTALLATION/APPLICATION CRITERIA:

- ▶ Provide upgradient sediment controls, such as silt fence during construction of inlet.
- ▶ When construction of inlet is complete, excavate adjacent area 1 to 2 feet lower than the grate elevation. Size of excavated area should be based on soil type and contributing acreage.

LIMITATIONS:

- ▶ Recommended maximum contributing drainage area of one acre.
- ▶ Limited to inlets located in open unpaved areas.
- ▶ Requires flat area adjacent to inlet.

MAINTENANCE:

- ▶ Inspect inlet protection following storm event and at a minimum of once monthly.
- ▶ Remove accumulated sediment when it reaches one half of the excavated sump below the grate.
- ▶ Repair side slopes as required.

OBJECTIVES

- Housekeeping Practices
- Contain Waste
- Minimize Disturbed Areas
- Stabilize Disturbed Areas
- Protect Slopes/Channels
- Control Site Perimeter
- Control Internal Erosion



WEBER COUNTY

ENGINEERING DEPARTMENT

2380 Washington Blvd., Suite 240
Ogden, UT 84401
(801) 399-8374

TARGETED POLLUTANTS

- Sediment
- Nutrients
- Toxic Materials
- Oil & Grease
- Floatable Materials
- Other Waste

- High Impact
- Medium Impact
- Low or Unknown Impact

IMPLEMENTATION REQUIREMENTS

- Capital Costs
- O&M Costs
- Maintenance
- Training

- High
- Medium
- Low

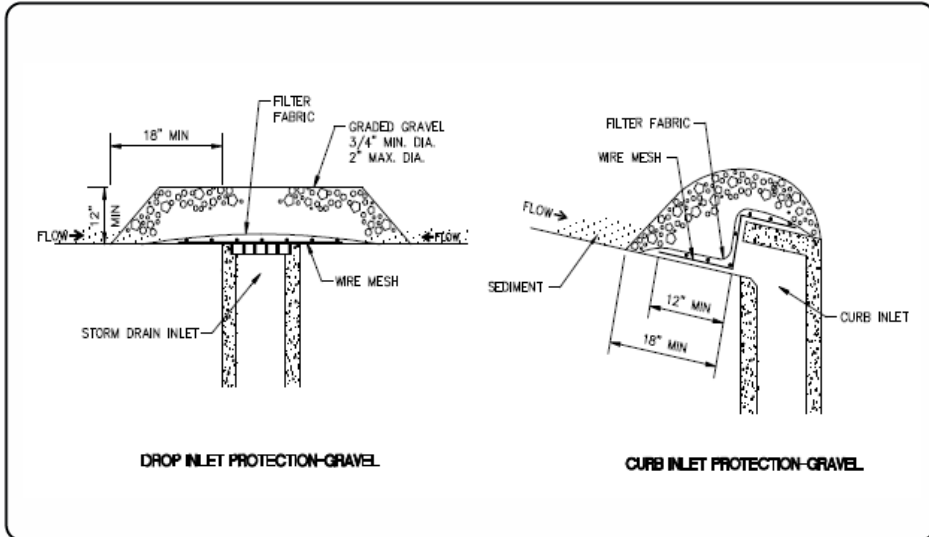

- ### OBJECTIVES
- Housekeeping Practices
 - Contain Waste
 - Minimize Disturbed Areas
 - Stabilize Disturbed Areas
 - Protect Slopes/Channels
 - Control Site Perimeter
 - Control Internal Erosion



WEBER COUNTY

ENGINEERING DEPARTMENT

2380 Washington Blvd., Suite 240
 Ogden, UT 84401
 (801) 399-8374

DESCRIPTION:

Placement of gravel filter over inlet to storm drains to filter storm water runoff.

APPLICATION:

- ▶ Construct at inlets in paved or unpaved areas where upgradient area is to be disturbed by construction activities.

INSTALLATION/APPLICATION CRITERIA:

- ▶ Place wire mesh (with 1/2 inch openings) over the inlet grate extending one foot past the grate in all directions.
- ▶ Place filter fabric over the mesh. Filter fabric should be selected based on soil type.
- ▶ Place graded gravel, to a minimum depth of 12-inches, over the filter fabric and extending 18-inches past the grate in all directions.

LIMITATIONS:

- ▶ Recommended for maximum drainage area of one acre.
- ▶ Excess flows may bypass the inlet requiring down gradient controls.
- ▶ Ponding will occur at inlet.

MAINTENANCE:

- ▶ Inspect inlet protection after every large storm event and at a minimum of once monthly.
- ▶ Remove sediment accumulated when it reaches 4-inches in depth.
- ▶ Replace filter fabric and clean or replace gravel if clogging is apparent.

- ### TARGETED POLLUTANTS
- Sediment
 - Nutrients
 - Toxic Materials
 - Oil & Grease
 - Floatable Materials
 - Other Waste
-
- High Impact
 - Medium Impact
 - Low or Unknown Impact

- ### IMPLEMENTATION REQUIREMENTS
- Capital Costs
 - O&M Costs
 - Maintenance
 - Training
-
- High
 - Medium
 - Low



DESCRIPTION:

Litter control involves the removal of litter from streets and other surfaces before runoff or wind moves these materials to surface waters. This practice will prevent litter from becoming pollution as well as improving the aesthetics of the area.

APPROACH:

There are two categories of litter control programs: source reduction and removal programs.

Source reduction:

- ▶ Litter containers should be conveniently placed and emptied frequently to prevent overflow.
- ▶ Recycling programs should be promoted.
- ▶ Public education programs should be developed since litter control programs depend upon public support.

Litter removal programs:

- ▶ Litter control program include refuse and leaf collection, street cleaning, and catch basin cleaning.
- ▶ Educational programs that explain the environmental benefit of leaf collection to water quality are helpful.
- ▶ Municipal leaf collection is usually accomplished with street sweepers (see Street Cleaning BMP) or mechanical lawn sweepers.

LIMITATIONS:

- ▶ No limitations.

OBJECTIVES

- New Development
- Residential
- Commercial Activities
- Industrial Activities
- Municipal Facilities
- Illegal Discharges



WEBER COUNTY

ENGINEERING DEPARTMENT

2380 Washington Blvd., Suite 240
Ogden, UT 84401
(801) 399-8374

TARGETED POLLUTANTS

- Sediment
- Nutrients
- Heavy Metals
- Toxic Materials
- Oxygen Demanding Substance
- Oil & Grease
- Floatable Materials
- Bacteria & Viruses
- High Impact
- Medium Impact
- Low or Unknown Impact

IMPLEMENTATION REQUIREMENTS

- Capital Costs
- O&M Costs
- Regulatory
- Training
- Staffing
- Administrative
- High
- Medium
- Low

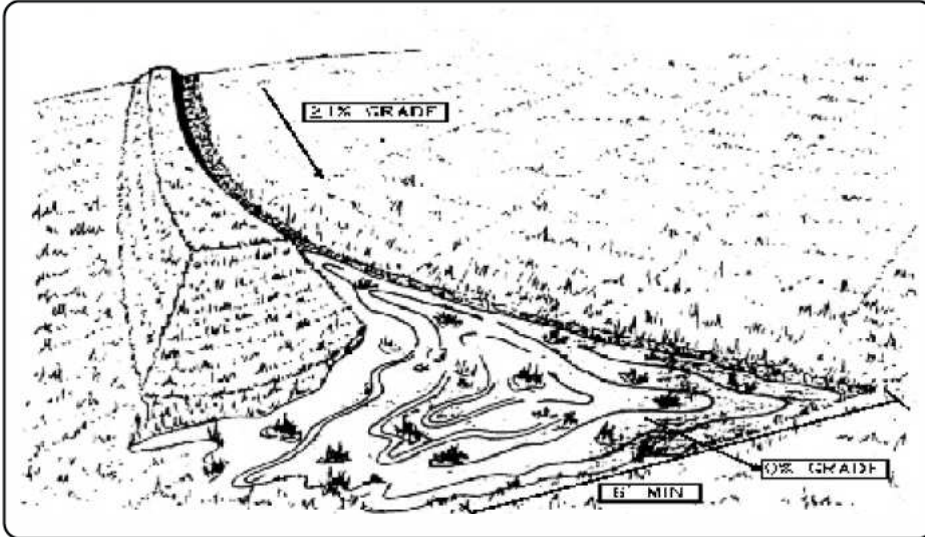

DESCRIPTION:

Level spreaders are devices used at stormwater outlets to spread out collected stormwater flows into sheetflow (runoff that flows over ground surface in a thin, even layer). Typically, a level spreader consists of a depression in the soil surface that spreads the flow onto a flat area across a gentle slope. Level spreaders then release the stormwater flow onto level areas stabilized by vegetation to reduce speed and increase infiltration.

APPLICATION:

- ▶ Level spreaders are most often used as an outlet for temporary or permanent stormwater conveyances or dikes. Runoff that contains high sediment loads should be treated in a sediment trapping device prior to release into a level spreader.

INSTALLATION/APPLICATION CRITERIA:

- ▶ The length of the spreader depends upon the amount of water that flows through the conveyance.
- ▶ Larger volumes of water need more space to even out.
- ▶ Level spreaders are generally used with filter strips (see Filter Strips BMP).
- ▶ The depressions are seeded with vegetation (see Permanent & Temporary Seeding BMP).
- ▶ Level spreaders should be constructed on natural soils and not on fill material.
- ▶ The entrance to the spreader should be level so that the flow can spread out evenly.
- ▶ Level Spreader should have a grade of 0%; minimum width should be 6' and minimum depth should be 6" minimum.

LIMITATIONS:

- ▶ Can easily develop "short circuiting" (concentration of flows into small streams instead of sheetflow over the spreader) because of erosion or other disturbance.
- ▶ Cannot handle large quantities of sediment-laden stormwater.

MAINTENANCE:

- ▶ The spreader should be inspected after every storm event to check for damage.
- ▶ If ponding or erosion channels develop, the spreader should be regraded.
- ▶ Dense vegetation should be maintained and damaged areas reseeded as needed.

CONSIDERATIONS

- Soils
- Area Required
- Slope
- Water Availability
- Aesthetics
- Hydraulic Head
- Environmental Side Effects



WEBER COUNTY

ENGINEERING DEPARTMENT

2380 Washington Blvd., Suite 240
Ogden, UT 84401
(801) 399-8374

TARGETED POLLUTANTS

- Sediment
- Nutrients
- Heavy Metals
- Toxic Materials
- Oxygen Demanding Substance
- Oil & Grease
- Floatable Materials
- Bacteria & Viruses
- High Impact
- Medium Impact
- Low or Unknown Impact

IMPLEMENTATION REQUIREMENTS

- Capital Costs
- O&M Costs
- Maintenance
- Training
- High
- Medium
- Low

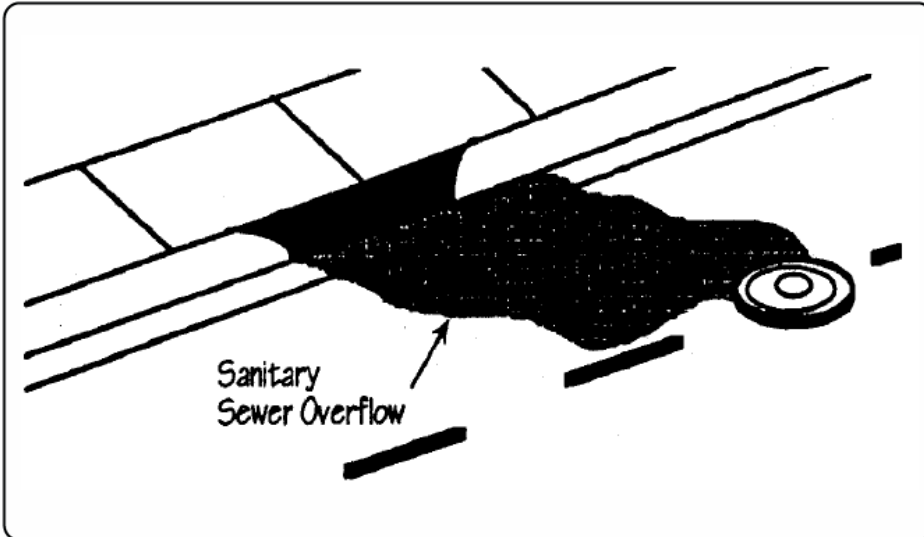

OBJECTIVES

- New Development
- Residential
- Commercial Activities
- Industrial Activities
- Municipal Facilities
- Illegal Discharges



WEBER COUNTY

ENGINEERING DEPARTMENT

2380 Washington Blvd., Suite 240
Ogden, UT 84401
(801) 399-8374

DESCRIPTION:

Implement control procedures for identifying, repairing, and remediation of sewer blockages, infiltration, inflow, and wet weather overflows from sanitary sewers into the storm drain conveyance system. Procedures include field screening, follow-up testing, and complaint investigation.

APPROACH:

- ▶ Identify dry weather infiltration and inflow first. Wet weather overflow connections are very difficult to locate.
- ▶ Locate wet weather overflows and leaking sanitary sewers using conventional source identification techniques.
- ▶ Coordinate with ongoing infiltration and inflow (I & I) program to locate sources of exfiltration during I & I inspections.
- ▶ Design, site, operate, and maintain on-site sewage disposal systems to prevent nutrient/pathogen loadings to surface waters and to reduce loadings to groundwater.

Leaking sanitary sewer detection techniques include:

- ▶ Field screening program (including field analytical testing),
- ▶ Fluorometric dye testing,
- ▶ Zinc chloride smoke testing,
- ▶ Television camera inspection,
- ▶ Nessler Reagent test kits for ammonia detection,
- ▶ Citizens' hotline reporting of wet weather sanitary overflows.

LIMITATIONS:

- ▶ Private property access rights needed to perform field screening/testing along storm drain right-of-ways.
- ▶ Requirements of municipal ordinance authority for suspected source verification testing necessary for guaranteed rights of entry.

TARGETED POLLUTANTS

- Sediment
- Nutrients
- Heavy Metals
- Toxic Materials
- Oxygen Demanding Substance
- Oil & Grease
- Floatable Materials
- Bacteria & Viruses

- High Impact
- Medium Impact
- Low or Unknown Impact

IMPLEMENTATION REQUIREMENTS

- Capital Costs
- O&M Costs
- Regulatory
- Training
- Staffing
- Administrative

- High
- Medium
- Low

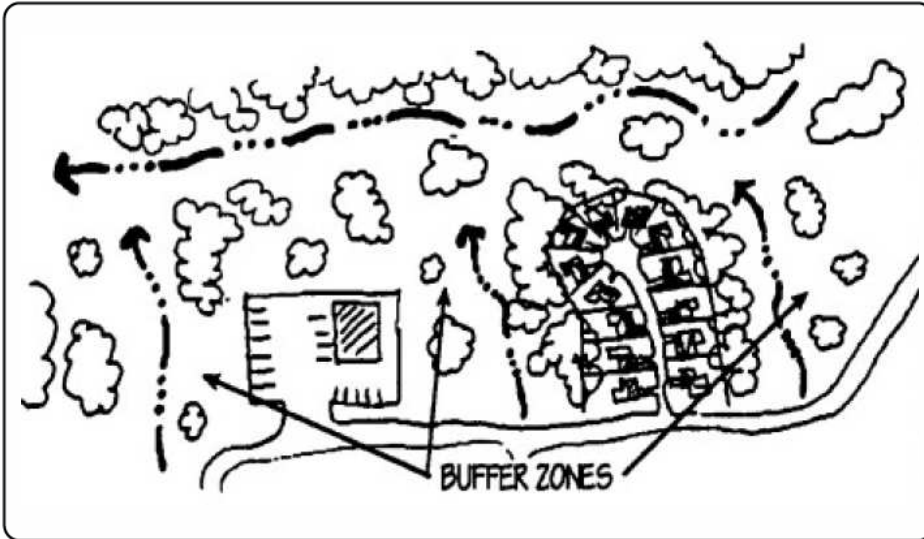

DESCRIPTION:

This BMP represents an important opportunity to reduce pollutants in stormwater runoff by using a comprehensive planning process to integrate water quality concerns into the development and redevelopment process. It is applicable to all types of land use and represents one of the most effective pollution prevention practices.

APPROACH:

The land use planning process need not be complex. A basic schematic model involves:

- ▶ Phase 1 - Goals: Determine clear-cut water quality goals.
- ▶ Phase 2 - Study: Identify planning area, gather pertinent data, and write a description of the planning area and its associated problems.
- ▶ Phase 3 - Analysis and Synthesis: Determine and prioritize the water quality needs as they relate to land use.
- ▶ Phase 4 - Recommendations: Future courses of action are developed to address the identified problems and needs determined previously.
- ▶ Phase 5 - Adoption: The recommendations are presented to a political body for acceptance and implementation.
- ▶ Phase 6 - Implementation: Recommendations adopted by the political body are implemented by the locality.

LIMITATIONS:

- ▶ Land use planning/management frequently address sensitive public issues. Restrictions on certain land uses for the purpose of mitigating stormwater pollution may be politically unacceptable.
- ▶ The use of land use controls and planning for water quality improvements may be limited by the lack of staff to enforce various aspects of local zoning and building codes.
- ▶ The planning process addresses many public needs and legal requirements which often are in conflict with one another. It is difficult but extremely important to integrate and balance these sometimes competing programs.

OBJECTIVES

- New Development
- Residential
- Commercial Activities
- Industrial Activities
- Municipal Facilities
- Illegal Discharges



WEBER COUNTY

ENGINEERING DEPARTMENT

2380 Washington Blvd., Suite 240
Ogden, UT 84401
(801) 399-8374

TARGETED POLLUTANTS

- Sediment
- Nutrients
- Heavy Metals
- Toxic Materials
- Oxygen Demanding Substance
- Oil & Grease
- Floatable Materials
- Bacteria & Viruses
- High Impact
- Medium Impact
- Low or Unknown Impact

IMPLEMENTATION REQUIREMENTS

- Capital Costs
- O&M Costs
- Regulatory
- Training
- Staffing
- Administrative
- High
- Medium
- Low



DESCRIPTION:

Placement of material such as straw, grass, woodchips, woodfibers or fabricated matting over open area.

APPLICATION:

- ▶ Any exposed area to remain untouched longer than 14 days and that will be exposed less than 60 days (seed areas to be exposed in excess of 60 days).
- ▶ Areas that have been seeded.
- ▶ Stockpiled soil material.

Material	Application	Depth	Comments
Gravel: Washed 1/4" to 1-1/2"	9 cy/1000 s f	3 inches	Good for traffic areas Good for short slopes
Straw: Air-dried, free of seeds and coarse material	2-3 bales /1000 s f	2 inches min.	Subject to wind blowing Tack down or keep moist
Wood Fiber Cellulose: Free from growth inhibitors; dyed green	35 lb/1000 s f	1 inch	For critical areas, double application rate; Limit to slopes < 3% and < 150 feet

INSTALLATION/APPLICATION CRITERIA:

- ▶ Roughen area to receive mulch to create depressions that mulch material can settle into.
- ▶ Apply mulch to required thickness and anchor as necessary.
- ▶ Ensure material used is weed free and does not contain any constituents that will inhibit plant growth.

LIMITATIONS:

- ▶ Anchoring may be required to prevent migration of mulch material.
- ▶ Down gradient control may be required to prevent mulch material being transported to storm water system.

MAINTENANCE:

- ▶ Inspect mulched areas after every rainfall event and at a minimum of monthly.
- ▶ Replace mulch on any bare areas and reanchor as necessary.
- ▶ Clean and replace down gradient controls as necessary.

OBJECTIVES

- Housekeeping Practices
- Contain Waste
- Minimize Disturbed Areas
- Stabilize Disturbed Areas
- Protect Slopes/Channels
- Control Site Perimeter
- Control Internal Erosion



WEBER COUNTY

ENGINEERING DEPARTMENT

2380 Washington Blvd., Suite 240
Ogden, UT 84401
(801) 399-8374

TARGETED POLLUTANTS

- Sediment
- Nutrients
- Toxic Materials
- Oil & Grease
- Floatable Materials
- Other Waste

- High Impact
- Medium Impact
- Low or Unknown Impact

IMPLEMENTATION REQUIREMENTS

- Capital Costs
- O&M Costs
- Maintenance
- Training

- High
- Medium
- Low

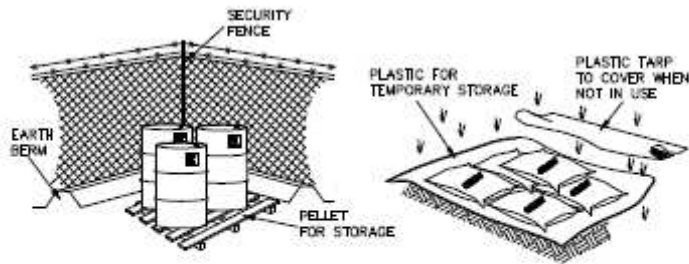

- ▶ CONTROLLED STORAGE LOCATION
- ▶ BERMED PERIMETER IMPOUNDMENT
- ▶ STORAGE OFF GROUND
- ▶ COVER WHEN NOT IN USE

DESCRIPTION:

Controlled storage of on-site materials.

APPLICATION:

- ▶ Storage of hazardous, toxic, and all chemical substances.
- ▶ Any construction site with outside storage of materials.

INSTALLATION/APPLICATION CRITERIA:

- ▶ Designate a secured area with limited access as the storage location. Ensure no waterways or drainage paths are nearby.
- ▶ Construct compacted earthen berm (See Earth Berm Barrier Information Sheet), or similar perimeter containment around storage location for impoundment in the case of spills.
- ▶ Ensure all on-site personnel utilize designated storage area. Do not store excessive amounts of material that will not be utilized on site.
- ▶ For active use of materials away from the storage area ensure materials are not set directly on the ground and are covered when not in use. Protect storm drainage during use.

LIMITATIONS:

- ▶ Does not prevent contamination due to mishandling of products.
- ▶ Spill Prevention and Response Plan still required.
- ▶ Only effective if materials are actively stored in controlled location.

MAINTENANCE:

- ▶ Inspect daily and repair any damage to perimeter impoundment or security fencing.
- ▶ Check materials are being correctly stored (i.e. standing upright, in labeled containers, tightly capped) and that no materials are being stored away from the designated location.

OBJECTIVES

- Housekeeping Practices
- Contain Waste
- Minimize Disturbed Areas
- Stabilize Disturbed Areas
- Protect Slopes/Channels
- Control Site Perimeter
- Control Internal Erosion



WEBER COUNTY

ENGINEERING DEPARTMENT

2380 Washington Blvd., Suite 240
Ogden, UT 84401
(801) 399-8374

TARGETED POLLUTANTS

- Sediment
- Nutrients
- Toxic Materials
- Oil & Grease
- Floatable Materials
- Other Construction Waste

- High Impact
- Medium Impact
- Low or Unknown Impact

IMPLEMENTATION REQUIREMENTS

- Capital Costs
- O&M Costs
- Maintenance
- Training

- High
- Medium
- Low



DESCRIPTION:

Prevent or reduce the discharge of pollutants to storm water from material use by using alternative products, minimizing hazardous material use on-site, and training employees and subcontractors.

APPLICATION:

The following materials are commonly used on construction sites:

- ▶ Pesticides and herbicides, fertilizers, detergents, plaster and other products, petroleum products such as fuel, oil, and grease.
- ▶ Other hazardous chemicals such as acids, lime, glues, paints, solvents, and curing compounds.

INSTALLATION/APPLICATION CRITERIA:

- ▶ Use less hazardous, alternative materials as much as possible.
- ▶ Minimize use of hazardous materials on-site.
- ▶ Use only materials where and when needed to complete the construction activity.
- ▶ Follow manufacturer's instructions regarding uses, protective equipment, ventilation, flammability, and mixing of chemicals.
- ▶ Personnel who use pesticides should be trained in their use.
- ▶ Do not over apply fertilizers, herbicides, and pesticides. Prepare only the amount needed.
- ▶ Unless on steep slopes, till fertilizers in to the soil rather than hydroseeding.
- ▶ Do not apply these chemicals just before it rains.

LIMITATIONS:

- ▶ Alternative materials may not be available, suitable, or effective in every case.

MAINTENANCE:

- ▶ Maintenance of this best management practice is minimal.

OBJECTIVES

- Housekeeping Practices
- Contain Waste
- Minimize Disturbed Areas
- Stabilize Disturbed Areas
- Protect Slopes/Channels
- Control Site Perimeter
- Control Internal Erosion



WEBER COUNTY

ENGINEERING DEPARTMENT

2380 Washington Blvd., Suite 240
Ogden, UT 84401
(801) 399-8374

TARGETED POLLUTANTS

- Sediment
 - Nutrients
 - Toxic Materials
 - Oil & Grease
 - Floatable Materials
 - Other Construction Waste
-
- High Impact
 - Medium Impact
 - Low or Unknown Impact

IMPLEMENTATION REQUIREMENTS

- Capital Costs
 - O&M Costs
 - Maintenance
 - Training
-
- High
 - Medium
 - Low



DESCRIPTION:

Eliminate non-stormwater discharges to the stormwater collection system. Nonstormwater discharges may include: process wastewaters, cooling waters, wash waters, and sanitary wastewater.

APPROACH:

The following approaches may be used to identify non-stormwater discharges:

- ▶ Visual inspection: the easiest method is to inspect each discharge point during dry weather. Keep in mind that drainage from a storm event can continue for three days or more and groundwater may infiltrate the underground stormwater collection system.
- ▶ Piping Schematic Review: The piping schematic is a map of pipes and drainage systems used to carry wastewater, cooling water, sanitary wastes, etc... A review of the “as-built” piping schematic is a way to determine if there are any connections to the stormwater collection system. Inspect the path of floor drains in older buildings.
- ▶ Smoke Testing: Smoke testing of wastewater and stormwater collection systems is used to detect connections between the two systems. During dry weather the stormwater collection system is filled with smoke and then traced to sources. The appearance of smoke at the base of a toilet indicates that there may be a connection between the sanitary and the stormwater system.
- ▶ Dye Testing: A dye test can be performed by simply releasing a dye into either the sanitary or process wastewater system and examining the discharge points from the stormwater collection system for discoloration.

LIMITATIONS:

- ▶ Many facilities do not have accurate, up-to-date schematic drawings.
- ▶ Video and visual inspections can identify illicit connections to the storm sewer, but further testing is sometimes required (e.g. dye, smoke) to identify sources.

OBJECTIVES

- Manufacturing
- Material Handling
- Vehicle Maintenance
- Construction
- Commercial Activities
- Roadways
- Waste Containment
- Housekeeping Practices



WEBER COUNTY

ENGINEERING DEPARTMENT

2380 Washington Blvd., Suite 240
Ogden, UT 84401
(801) 399-8374

TARGETED POLLUTANTS

- Sediment
- Nutrients
- Heavy Metals
- Toxic Materials
- Oxygen Demanding Substance
- Oil & Grease
- Floatable Materials
- Bacteria & Viruses
- High Impact
- Medium Impact
- Low or Unknown Impact

IMPLEMENTATION REQUIREMENTS

- Capital Costs
- O&M Costs
- Maintenance
- Training
- High
- Medium
- Low

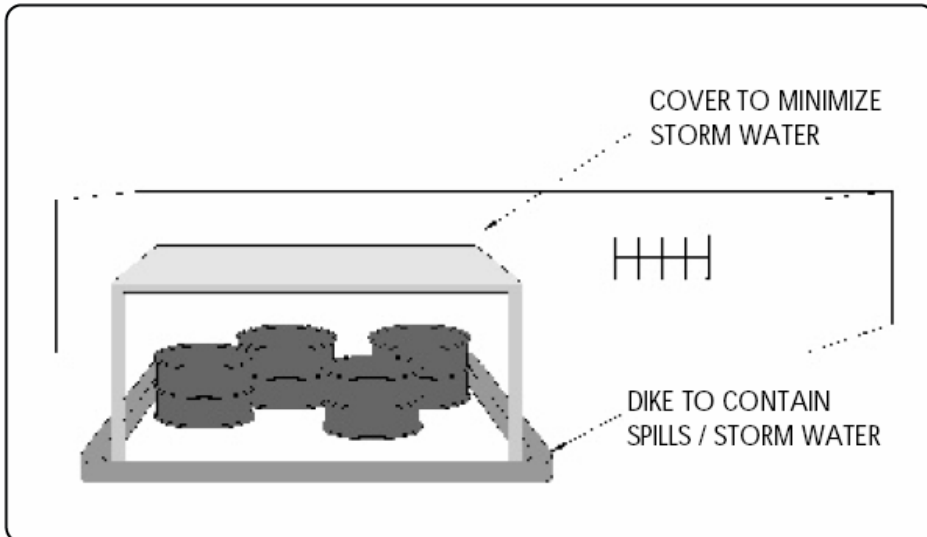

DESCRIPTION:

Prevent or reduce the discharge of pollutants to stormwater from outdoor container storage areas by installing safeguards against accidental releases, installing secondary containment, conducting regular inspections, and training employees in standard operating procedures and spill cleanup techniques.

APPROACH:

Protect materials from rainfall, runoff, runoff, and wind dispersal:

- ▶ Store materials indoors.
- ▶ Cover the storage area with roof.
- ▶ Minimize stormwater runoff by enclosing the area or building a berm around it.
- ▶ Use a "doghouse" for storage of liquid containers.
- ▶ Use covered dumpsters for waste product containers.

Storage of oil and hazardous materials must meet specific federal and state standards including:

- ▶ Secondary containment.
- ▶ Integrity and leak detection monitoring.
- ▶ Emergency preparedness plans.

Train operator on proper storage.

Safeguards against accidental releases:

- ▶ Overflow protection devices to warn operator or automatic shut down transfer pumps, protection guards (bollards) around tanks and piping to prevent vehicle or forklift damage, clear tagging or labeling, and restricting access to valves to reduce human error.

Berm or surround tank or container with secondary containment system:

- ▶ Dikes, liners, vaults, or double walled tanks.

Some municipalities require that secondary containment areas be connected to the sanitary sewer, prohibiting any hard connections to the storm drain.

LIMITATIONS:

- ▶ Storage sheds often must meet building and fire code requirements.

MAINTENANCE:

- ▶ Conduct routine weekly inspections.

OBJECTIVES

- Manufacturing
- Material Handling
- Vehicle Maintenance
- Construction
- Commercial Activities
- Roadways
- Waste Containment
- Housekeeping Practices



WEBER COUNTY

ENGINEERING DEPARTMENT

2380 Washington Blvd., Suite 240
Ogden, UT 84401
(801) 399-8374

TARGETED POLLUTANTS

- Sediment
- Nutrients
- Heavy Metals
- Toxic Materials
- Oxygen Demanding Substance
- Oil & Grease
- Floatable Materials
- Bacteria & Viruses
- High Impact
- Medium Impact
- Low or Unknown Impact

IMPLEMENTATION REQUIREMENTS

- Capital Costs
- O&M Costs
- Maintenance
- Training
- High
- Medium
- Low

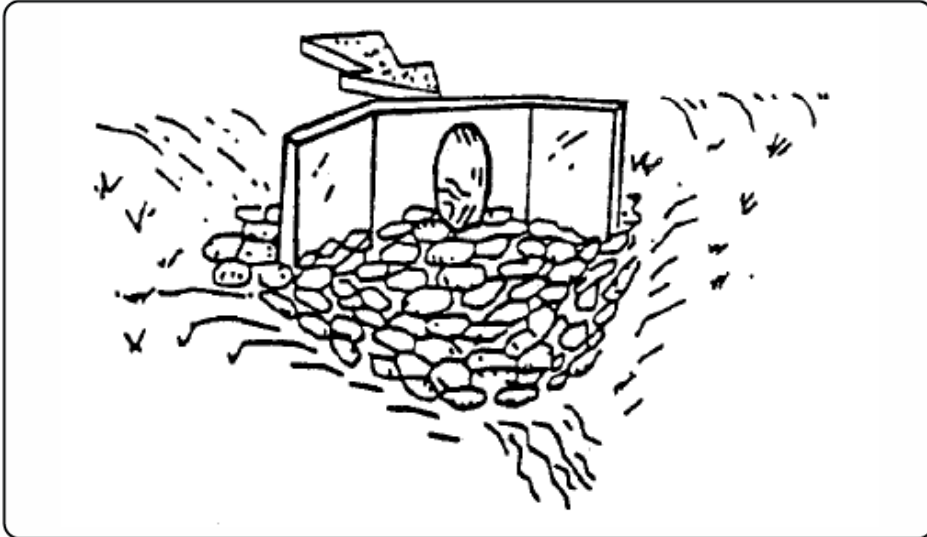

DESCRIPTION:

A rock outlet protection is a physical device composed of rock, grouted riprap, or concrete rubble which is placed at the outlet of a pipe to prevent scour of the soil caused by high pipe flow velocities, and to absorb flow energy to produce non-erosive velocities.

APPLICATIONS:

- ▶ Wherever discharge velocities and energies at the outlets of culverts, conduits, or channels are sufficient to erode the next downstream reach.
- ▶ Rock outlet protection is best suited for temporary use during construction because it is usually less expensive and easier to install than concrete aprons or an energy dissipator.
- ▶ A sediment trap below the pipe outlet is recommended if runoff is sediment laden.
- ▶ Permanent rock riprap protection should be designed and sized by the engineer as part of the culvert, conduit or channel design.
- ▶ Grouted riprap should be avoided in areas of freeze and thaw because the grout will break up.

INSTALLATION/APPLICATION CRITERIA:

- ▶ Rock outlet protection is effective when the rock is sized and placed properly. When this is accomplished, rock outlets do much to limit erosion at pipe outlets. Rock size should be increased for high velocity flows. Best results are obtained when sound, durable, angular rock is used.

LIMITATIONS:

- ▶ Large storms often wash away the rock outlet protection and leave the area susceptible to erosion.
- ▶ Sediment captured by the rock outlet protection may be difficult to remove without removing the rock.
- ▶ Outlet protection may negatively impact the channel habitat.

MAINTENANCE:

- ▶ Inspect after each significant rain for erosion and/or disruption of the rock, and repair immediately.
- ▶ Grouted or wire-tied rock riprap can minimize maintenance requirements.

OBJECTIVES

- Housekeeping Practices
- Contain Waste
- Minimize Disturbed Areas
- Stabilize Disturbed Areas
- Protect Slopes/Channels
- Control Site Perimeter
- Control Internal Erosion



WEBER COUNTY

ENGINEERING DEPARTMENT

2380 Washington Blvd., Suite 240
Ogden, UT 84401
(801) 399-8374

TARGETED POLLUTANTS

- Sediment
- Nutrients
- Toxic Materials
- Oil & Grease
- Floatable Materials
- Other Waste

- High Impact
- Medium Impact
- Low or Unknown Impact

IMPLEMENTATION REQUIREMENTS

- Capital Costs
- O&M Costs
- Maintenance
- Training

- High
- Medium
- Low

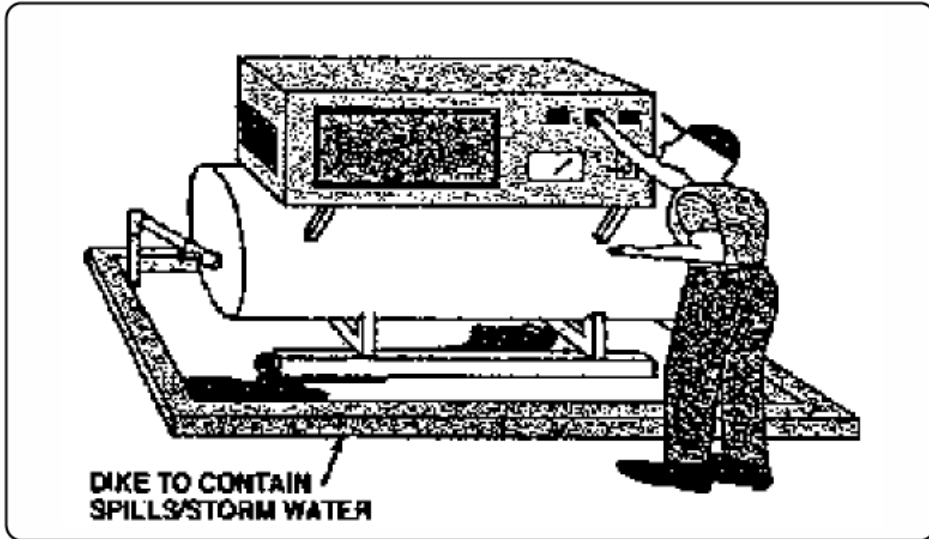

DESCRIPTION:

Prevent or reduce the discharge of pollutants to stormwater from outdoor process equipment operations and maintenance by reducing the amount of waste created, enclosing or covering all or some of the equipment, installing secondary containment, and training employees.

APPROACH:

- ▶ Alter the activity to prevent exposure of pollutants to stormwater.
- ▶ Move activity indoors.
- ▶ Cover the area with a permanent roof.
- ▶ Minimize contact of stormwater with outside manufacturing operations through berming and drainage routing (runon prevention).
- ▶ Connect process equipment area to public sewer or facility wastewater treatment system.
- ▶ Clean the storm drainage system regularly.
- ▶ Use catch basin filtration inserts as a means to capture particulate pollutants.
- ▶ Some municipalities require that secondary containment areas (regardless of size) be connected to the sanitary sewer, prohibiting any hard connections to the storm drain.

LIMITATIONS:

- ▶ Providing cover may be expensive.
- ▶ Space limitations may preclude enclosing some equipment.
- ▶ Storage sheds often must meet building and fire code requirements.

MAINTENANCE:

- ▶ Routine preventive maintenance, including checking process equipment for leaks.

OBJECTIVES

- Manufacturing
- Material Handling
- Vehicle Maintenance
- Construction
- Commercial Activities
- Roadways
- Waste Containment
- Housekeeping Practices



WEBER COUNTY

ENGINEERING DEPARTMENT

2380 Washington Blvd., Suite 240
Ogden, UT 84401
(801) 399-8374

TARGETED POLLUTANTS

- Sediment
- Nutrients
- Heavy Metals
- Toxic Materials
- Oxygen Demanding Substance
- Oil & Grease
- Floatable Materials
- Bacteria & Viruses
- High Impact
- Medium Impact
- Low or Unknown Impact

IMPLEMENTATION REQUIREMENTS

- Capital Costs
- O&M Costs
- Maintenance
- Training
- High
- Medium
- Low

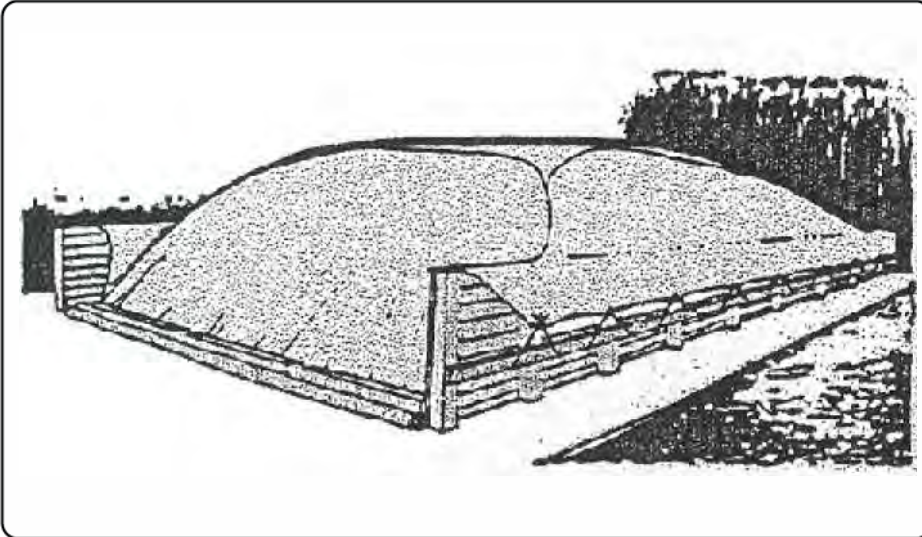

DESCRIPTION:

Prevent or reduce the discharge of pollutants to stormwater from outdoor materials and product storage areas by enclosing or covering materials, installing secondary containment, and preventing stormwater runoff.

APPROACH:

- ▶ Protect materials from rainfall, runoff, runoff and wind dispersal:
 - Store material indoors.
 - Cover the storage area with a roof.
 - Cover the material with a temporary covering made of polyethylene, polypropylene, or hypalon.
 - Minimize stormwater runoff by enclosing the area or building a berm around the area.
 - Use a "doghouse" for storage of liquid containers.
- ▶ Parking lots or other surfaces near bulk materials should be swept periodically to remove debris blown or washed from storage area.
- ▶ Install pellet traps at stormwater discharge points where plastic pellets are loaded and unloaded.
- ▶ Keep liquids in a designated area on a paved impervious surface within a secondary containment.
- ▶ Keep outdoor storage containers in good condition.
- ▶ Use berms and curbing.
- ▶ Use catch basin filtration inserts.

LIMITATIONS:

- ▶ Space limitations may preclude storing some materials indoors.
- ▶ Some municipalities require that secondary containment areas (regardless of size) be connected to the sanitary sewer, prohibiting any hard connections to the storm drain.
- ▶ Storage sheds often must meet building and fire code requirements.

MAINTENANCE:

- ▶ Berm and curbing repair and patching.

OBJECTIVES

- Manufacturing
- Material Handling
- Vehicle Maintenance
- Construction
- Commercial Activities
- Roadways
- Waste Containment
- Housekeeping Practices



WEBER COUNTY

ENGINEERING DEPARTMENT

2380 Washington Blvd., Suite 240
Ogden, UT 84401
(801) 399-8374

TARGETED POLLUTANTS

- Sediment
- Nutrients
- Heavy Metals
- Toxic Materials
- Oxygen Demanding Substance
- Oil & Grease
- Floatable Materials
- Bacteria & Viruses
- High Impact
- Medium Impact
- Low or Unknown Impact

IMPLEMENTATION REQUIREMENTS

- Capital Costs
- O&M Costs
- Maintenance
- Training
- High
- Medium
- Low

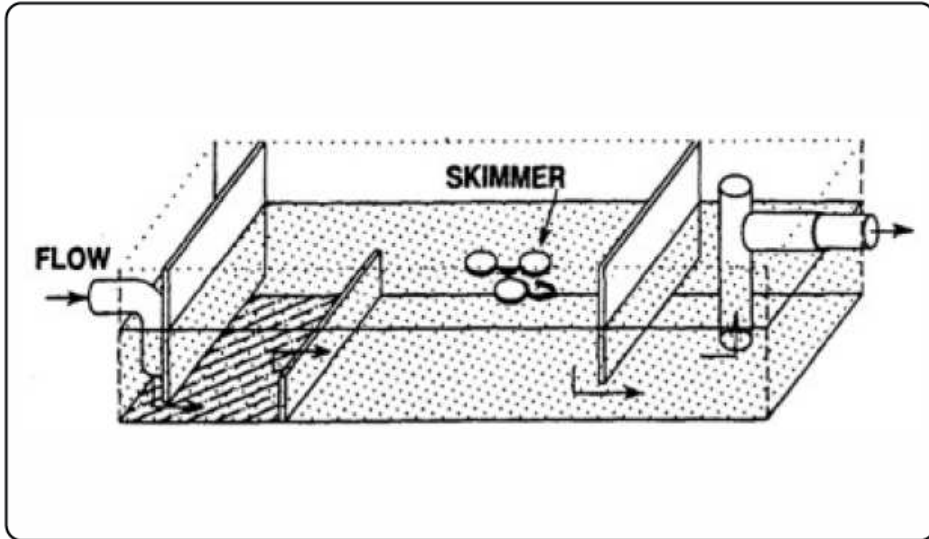

CONSIDERATIONS

- Soils
- Area Required
- Slope
- Water Availability
- Aesthetics
- Hydraulic Head
- Environmental Side Effects



WEBER COUNTY

ENGINEERING DEPARTMENT

2380 Washington Blvd., Suite 240
 Ogden, UT 84401
 (801) 399-8374

DESCRIPTION:

Oil/Water separators are designed to remove a specific group of contaminants: petroleum compounds and grease. However, separators will also remove floatable debris and settleable solids. Two general types of oil/water separators are used: conventional gravity separator and the coalescing plate interceptor (CPI).

APPLICATION:

- ▶ Applicable to situations where the concentration of oil and grease related compounds is abnormally high and source control cannot provide effective control. The general types of businesses where this situation is likely are truck, car, and equipment maintenance and washing businesses, as well as businesses that perform maintenance on their own equipment and vehicles.
- ▶ Public facilities where separators may be required include marine ports, airfields, fleet vehicle maintenance and washing, facilities, and mass transit park-and-ride lots.
- ▶ Conventional separators are capable of removing oil droplets with diameters equal to or greater than 150 microns.
- ▶ A CPI separator should be used if smaller droplets must be removed.

INSTALLATION/APPLICATION CRITERIA:

- ▶ Sizing relates to anticipated influent oil concentration, water temperature and velocity, and the effluent goal.
- ▶ To maintain a reasonable separator size, it should be designed to bypass flows in excess of first flush.

LIMITATIONS:

- ▶ The lack of data on oil characteristics in stormwater leads to considerable uncertainty about performance.
- ▶ An air quality permit may be required.

MAINTENANCE:

- ▶ Clean frequently of accumulated oil, grease, and floating debris.

TARGETED POLLUTANTS

- Sediment
- Nutrients
- Heavy Metals
- Toxic Materials
- Oxygen Demanding Substance
- Oil & Grease
- Floatable Materials
- Bacteria & Viruses
- High Impact
- Medium Impact
- Low or Unknown Impact

IMPLEMENTATION REQUIREMENTS

- Capital Costs
- O&M Costs
- Maintenance
- Training
- High
- Medium
- Low

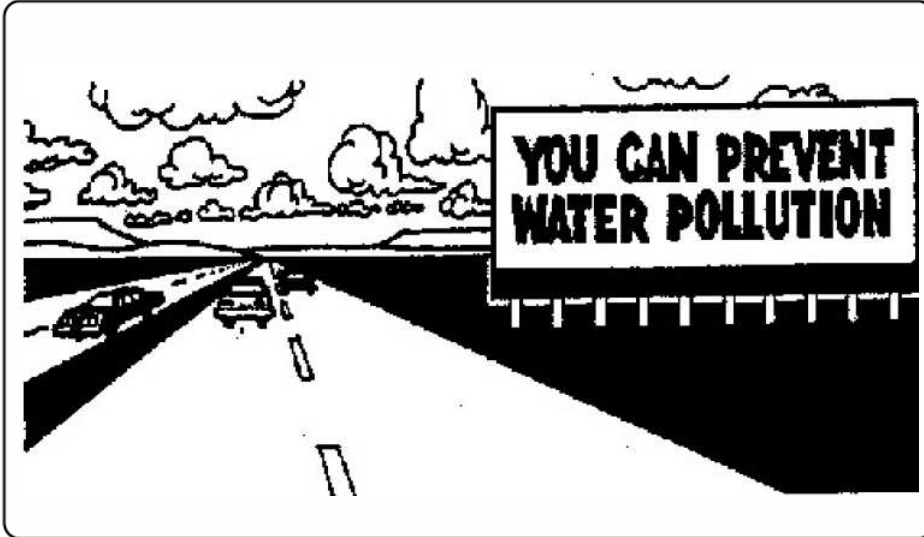

DESCRIPTION:

Public education/participation, like an ordinance or a piece of equipment, is not so much a best management practice as it is a method by which to implement BMPs. This information sheet highlights the importance of integrating elements of public education and participation into a municipality's overall plan for stormwater quality management.

A public education and participation plan provides the municipality with a strategy for educating its employees, the public, and businesses about the importance of protecting stormwater from improperly used, stored, and disposed of pollutants. Municipal employees must be trained, especially those that work in departments not directly related to stormwater but whose actions affect stormwater. Residents must become aware that a variety of hazardous products are used in the home and that their improper use and disposal can pollute stormwater. Increased public awareness also facilitates public scrutiny of industrial and municipal activities and will likely increase public reporting of incidents.

APPROACH:

- ▶ Pattern a new program after the many established programs around the country.
- ▶ Implement public education/participation as a coordinated campaign in which each message is related to the last.
- ▶ Present a clear and consistent message and image to the public regarding how they contribute to stormwater pollution and what they can do to reduce it.
- ▶ Utilize multi-media to reach the full range of audiences.
- ▶ Translate messages into the foreign languages of the community to reach the full spectrum of your populace and to avoid misinterpretation of messages.
- ▶ Create an awareness and identification with the local watershed.
- ▶ Use everyday language in all public pieces. Use outside reviewers to highlight and reduce the use of technical terminology, acronyms, and jargon.
- ▶ Make sure all statements have a sound, up-to-date technical basis. Do not contribute to the spread of misinformation.
- ▶ Break complicated subjects into smaller more simple concepts. Present these concepts to the public in a metered and organized way to avoid "overloading" and confusing the audience.

LIMITATIONS:

- ▶ None.

OBJECTIVES

- New Development
- Residential
- Commercial Activities
- Industrial Activities
- Municipal Facilities
- Illegal Discharges



WEBER COUNTY

ENGINEERING DEPARTMENT

2380 Washington Blvd., Suite 240
Ogden, UT 84401
(801) 399-8374

TARGETED POLLUTANTS

- Sediment
- Nutrients
- Heavy Metals
- Toxic Materials
- Oxygen Demanding Substance
- Oil & Grease
- Floatable Materials
- Bacteria & Viruses

- High Impact
- Medium Impact
- Low or Unknown Impact

IMPLEMENTATION REQUIREMENTS

- Capital Costs
- O&M Costs
- Regulatory
- Training
- Staffing
- Administrative

- High
- Medium
- Low

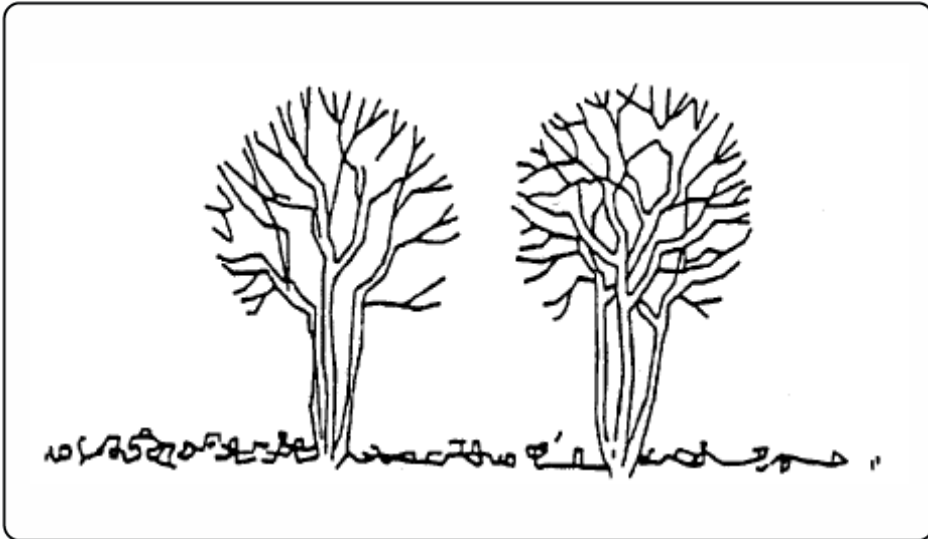

DESCRIPTION:

Carefully planned preservation of existing vegetation minimizes the potential of removing or injuring existing trees, vines, shrubs and/or grasses that serve as erosion controls.

APPLICATIONS:

- ▶ This technique is applicable to all types of sites. Areas where preserving vegetation can be particularly beneficial are floodplains, wetlands, stream banks, steep slopes, and other areas where erosion controls would be difficult to establish, install, or maintain.

INSTALLATION/APPLICATION CRITERIA:

- ▶ Clearly mark, flag or fence vegetation or areas where vegetation should be preserved.
- ▶ Prepare landscaping plans which include as much existing vegetation as possible and state proper care during and after construction.
- ▶ Define and protect with berms, fencing, signs, etc. a setback area from vegetation to be preserved.
- ▶ Propose landscaping plans which do not include plant species that compete with the existing vegetation.
- ▶ Do not locate construction traffic routes, spoil piles, etc. where significant adverse impact on existing vegetation may occur.

LIMITATIONS:

- ▶ Requires forward planning by the owner/developer, contractor and design staff.
- ▶ For sites with diverse topography, it is often difficult and expensive to save existing trees while grading the site satisfactorily for the planned development.
- ▶ May not be cost effective with high land costs.

MAINTENANCE:

- ▶ Inspection and maintenance requirements for protection of vegetation are low.
- ▶ Maintenance of native trees or vegetation should conform to landscape plan specifications.

OBJECTIVES

- Housekeeping Practices
- Contain Waste
- Minimize Disturbed Areas
- Stabilize Disturbed Areas
- Protect Slopes/Channels
- Control Site Perimeter
- Control Internal Erosion



WEBER COUNTY

ENGINEERING DEPARTMENT

2380 Washington Blvd., Suite 240
Ogden, UT 84401
(801) 399-8374

TARGETED POLLUTANTS

- Sediment
- Nutrients
- Toxic Materials
- Oil & Grease
- Floatable Materials
- Other Waste

- High Impact
- Medium Impact
- Low or Unknown Impact

IMPLEMENTATION REQUIREMENTS

- Capital Costs
- O&M Costs
- Maintenance
- Training

- High
- Medium
- Low

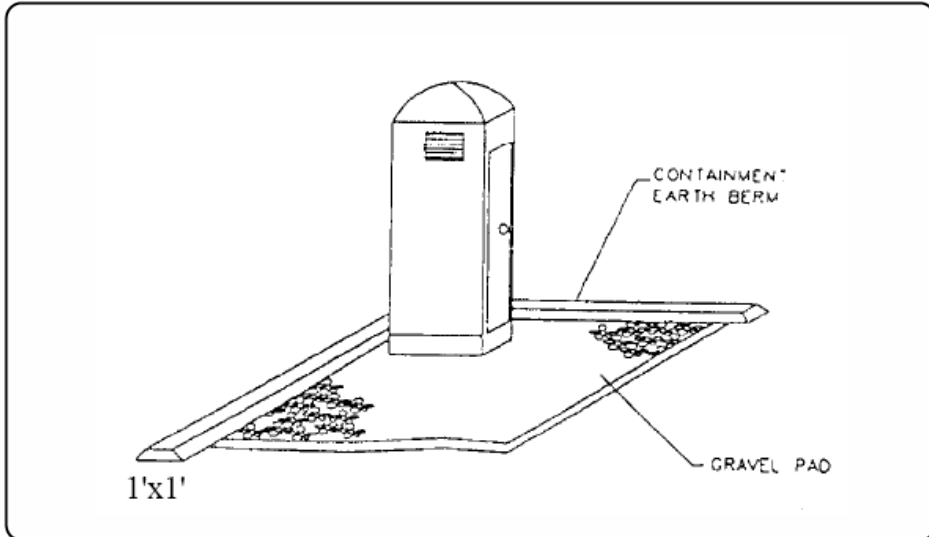

DESCRIPTION:

Temporary on-site sanitary facilities for construction personnel.

APPLICATION:

- ▶ All sites with no permanent sanitary facilities or where permanent facility is too far from activities.

INSTALLATION/APPLICATION CRITERIA:

- ▶ Locate portable toilets in convenient locations throughout the site.
- ▶ Prepare level, gravel surface and provide clear access to the toilets for servicing and for on-site personnel.
- ▶ Construct earth berm perimeter (See Earth Berm Barrier Information Sheet), control for spill/protection leak.

LIMITATIONS:

No limitations.

MAINTENANCE:

- ▶ Portable toilets should be maintained in good working order by licensed service with daily observation for leak detection.
- ▶ Regular waste collection should be arranged with licensed service.
- ▶ All waste should be deposited in sanitary sewer system for treatment with appropriate agency approval.

OBJECTIVES

- Housekeeping Practices
- Contain Waste
- Minimize Disturbed Areas
- Stabilize Disturbed Areas
- Protect Slopes/Channels
- Control Site Perimeter
- Control Internal Erosion



WEBER COUNTY

ENGINEERING DEPARTMENT

2380 Washington Blvd., Suite 240
Ogden, UT 84401
(801) 399-8374

TARGETED POLLUTANTS

- Sediment
- Nutrients
- Toxic Materials
- Oil & Grease
- Floatable Materials
- Other Construction Waste

- High Impact
- Medium Impact
- Low or Unknown Impact

IMPLEMENTATION REQUIREMENTS

- Capital Costs
- O&M Costs
- Maintenance
- Training

- High
- Medium
- Low



CONSIDERATIONS

- Soils
- Area Required
- Slope
- Water Availability
- Aesthetics
- Hydraulic Head
- Environmental Side Effects



WEBER COUNTY

ENGINEERING DEPARTMENT

2380 Washington Blvd., Suite 240
Ogden, UT 84401
(801) 399-8374

DESCRIPTION:

Riprap is a permanent, erosion-resistant protective layer made of loose stones. It is intended to protect soil from erosion in areas of concentrated runoff. Riprap may also be used to stabilize slopes that are unstable because of seepage problems.

APPLICATION:

- ▶ Riprap is normally used at locations where erosive forces from water flow exceed the ability of the soil or vegetative cover to resist those forces.
- ▶ Riprap can be used for pipe outlet protection, channel lining, scour protection, etc.
- ▶ Riprap is commonly used for wave protection on lakes.

INSTALLATION/APPLICATION CRITERIA:

- ▶ For slopes steeper than 2:1, consider using materials other than riprap for erosion protection.
- ▶ If riprap is being planned for the bottom of a permanently flowing channel, the bottom can be modified to enhance fish habitat. This can be done by constructing riffles and pools which simulate natural conditions.
- ▶ When working within flowing streams, measures should be taken to prevent excessive turbidity and erosion during construction. Bypassing base flows or temporarily blocking base flows are two possible methods. Work should be done during a period of low flow.

In designing riprap consider the following:

- ▶ Use durable rock, such as granite, and a variety of rock sizes.
- ▶ The thickness of riprap layers should be at least 1.25 times the max. stone diameter.
- ▶ Filter material is usually required between riprap and the underlying soil surface.

LIMITATIONS:

- ▶ Riprap may be unstable on very steep slopes.
- ▶ The placement of a riprap in streams requires a state stream alteration permit.

MAINTENANCE:

- ▶ Riprap should be inspected annually and after major storms.
- ▶ If riprap has been damaged, repairs should be made promptly to prevent a progressive failure.
- ▶ If repairs are needed repeatedly at one location, the site should be evaluated to see if original design conditions have changed.

TARGETED POLLUTANTS

- Sediment
- Nutrients
- Heavy Metals
- Toxic Materials
- Oxygen Demanding Substance
- Oil & Grease
- Floatable Materials
- Bacteria & Viruses
- High Impact
- Medium Impact
- Low or Unknown Impact

IMPLEMENTATION REQUIREMENTS

- Capital Costs
- O&M Costs
- Maintenance
- Training
- High
- Medium
- Low

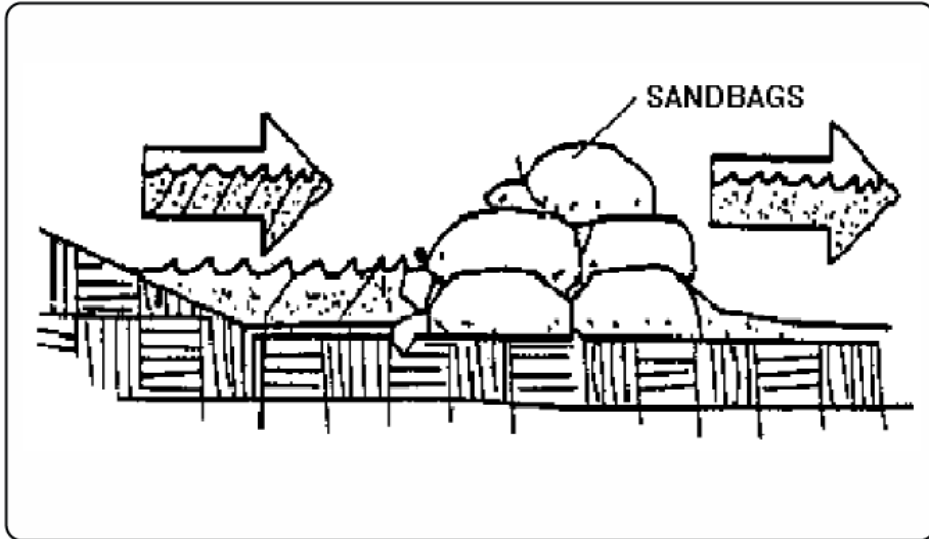

DESCRIPTION:

Stacking sand bags along a level contour creates a barrier which detains sediment laden water, ponding water upstream of the barrier and promoting sedimentation.

APPLICATION:

- ▶ Along the perimeter of the site.
- ▶ May be used in drainage areas up to 5 acres.
- ▶ Along streams and channels
- ▶ Across swales with small catchments.
- ▶ Around temporary spoil areas.
- ▶ Below the toe of a cleared slope.

INSTALLATION/APPLICATION CRITERIA:

- ▶ Install along a level contour.
- ▶ Base of sand bag barrier should be at least 48 inches wide.
- ▶ Height of sand bag barrier should be at least 18 inches high.
- ▶ 4 inch PVC pipe may be installed between the top layers of sand bags to drain large flood flows.
- ▶ Provide area behind barrier for runoff to pond and sediment to settle.
- ▶ Place below the toe of a slope.

LIMITATIONS:

- ▶ Sand bags are more expensive than other barriers, but also more durable.
- ▶ Burlap should not be used.

MAINTENANCE:

- ▶ Inspect after each rain.
- ▶ Reshape or replace damaged sand bags immediately.
- ▶ Replace sediment when it reaches six inches in depth.

OBJECTIVES

- Housekeeping Practices
- Contain Waste
- Minimize Disturbed Areas
- Stabilize Disturbed Areas
- Protect Slopes/Channels
- Control Site Perimeter
- Control Internal Erosion



WEBER COUNTY

ENGINEERING DEPARTMENT

2380 Washington Blvd., Suite 240
Ogden, UT 84401
(801) 399-8374

TARGETED POLLUTANTS

- Sediment
- Nutrients
- Toxic Materials
- Oil & Grease
- Floatable Materials
- Other Waste

- High Impact
- Medium Impact
- Low or Unknown Impact

IMPLEMENTATION REQUIREMENTS

- Capital Costs
- O&M Costs
- Maintenance
- Training

- High
- Medium
- Low



DESCRIPTION:

Reduce the discharges of pollutants to stormwater from street surfaces by conducting street cleaning on a regular basis.

APPROACH:

- ▶ Prioritize cleaning to use the most sophisticated sweepers, at the highest frequency, and in areas with the highest pollutant loading.
- ▶ Restrict street parking prior to and during sweeping.
- ▶ Increase sweeping frequency just before the rainy season.
- ▶ Proper maintenance and operation of sweepers greatly increase their efficiency.
- ▶ Keep accurate operation logs to track programs.
- ▶ Reduce the number of parked vehicles using regulations.
- ▶ Sweepers effective at removing smaller particles (less than 10 microns) may generate dust that would lead to concerns over worker and public safety.
- ▶ Equipment selection can be key for this particular BMP. There are two types used, the mechanical broom sweepers (more effective at picking up large debris and cleaning wet streets), and the vacuum sweepers (more effective at removing fine particles and associated heavy metals). Many communities find it useful to have a compliment of both types in their fleet.

LIMITATIONS:

- ▶ Conventional sweepers are not able to remove oil and grease.
- ▶ Mechanical sweepers are not effective at removing finer sediments.
- ▶ Effectiveness may also be limited by street conditions, traffic congestion, presence of construction projects, climatic conditions and condition of curbs.

MAINTENANCE:

- ▶ Replace worn parts as necessary.
- ▶ Install main and gutter brooms of the appropriate weight.

OBJECTIVES

- New Development
- Residential
- Commercial Activities
- Industrial Activities
- Municipal Facilities
- Illegal Discharges



WEBER COUNTY

ENGINEERING DEPARTMENT

2380 Washington Blvd., Suite 240
Ogden, UT 84401
(801) 399-8374

TARGETED POLLUTANTS

- Sediment
- Nutrients
- Heavy Metals
- Toxic Materials
- Oxygen Demanding Substance
- Oil & Grease
- Floatable Materials
- Bacteria & Viruses
- High Impact
- Medium Impact
- Low or Unknown Impact

IMPLEMENTATION REQUIREMENTS

- Capital Costs
- O&M Costs
- Regulatory
- Training
- Staffing
- Administrative
- High
- Medium
- Low

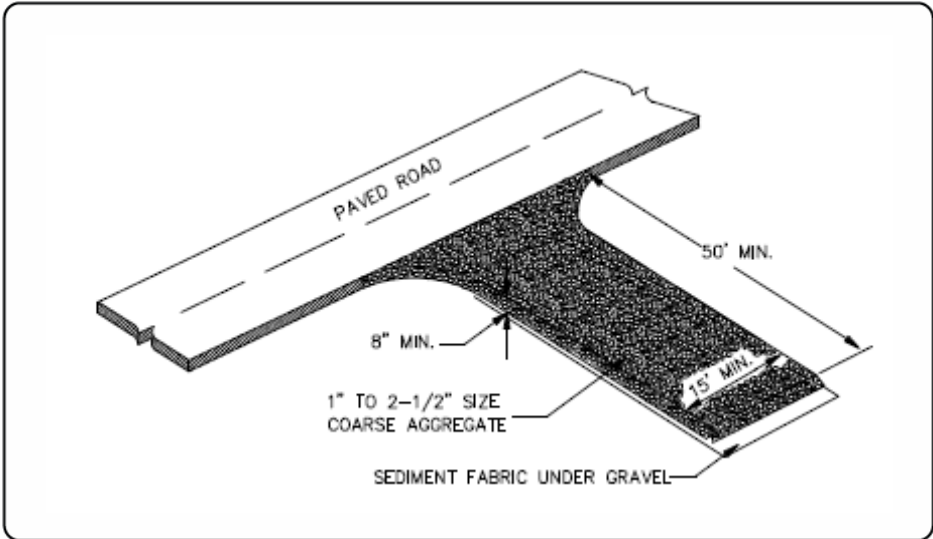

OBJECTIVES

- Housekeeping Practices
- Contain Waste
- Minimize Disturbed Areas
- Stabilize Disturbed Areas
- Protect Slopes/Channels
- Control Site Perimeter
- Control Internal Erosion



WEBER COUNTY

ENGINEERING DEPARTMENT

2380 Washington Blvd., Suite 240
 Ogden, UT 84401
 (801) 399-8374

DESCRIPTION:

A stabilized pad of crushed stone located where construction traffic enters or leaves the site from or to paved surface.

APPLICATIONS:

- ▶ At any point of ingress or egress at a construction site where adjacent traveled way is paved. Generally applies to sites over 2 acres unless special conditions exist.

INSTALLATION/APPLICATION CRITERIA:

- ▶ Clear and grub area and grade to provide maximum slope of 2%.
- ▶ Compact subgrade and place filter fabric if desired (recommended for entrances to remain for more than 3 months).
- ▶ Place coarse aggregate, 1 to 2-1/2 inches in size, to a minimum depth of 8 inches.

LIMITATIONS:

- ▶ Requires periodic top dressing with additional stones.
- ▶ Should be used in conjunction with street sweeping on adjacent public right-of-way.

MAINTENANCE:

- ▶ Inspect daily for loss of gravel or sediment buildup.
- ▶ Inspect adjacent roadway for sediment deposit and clean by sweeping or shoveling.
- ▶ Repair entrance and replace gravel as required to maintain control in good working condition.
- ▶ Expand stabilized area as required to accommodate traffic and prevent erosion at driveways.

TARGETED POLLUTANTS

- Sediment
- Nutrients
- Toxic Materials
- Oil & Grease
- Floatable Materials
- Other Waste

- High Impact
- Medium Impact
- Low or Unknown Impact

IMPLEMENTATION REQUIREMENTS

- Capital Costs
- O&M Costs
- Maintenance
- Training

- High
- Medium
- Low

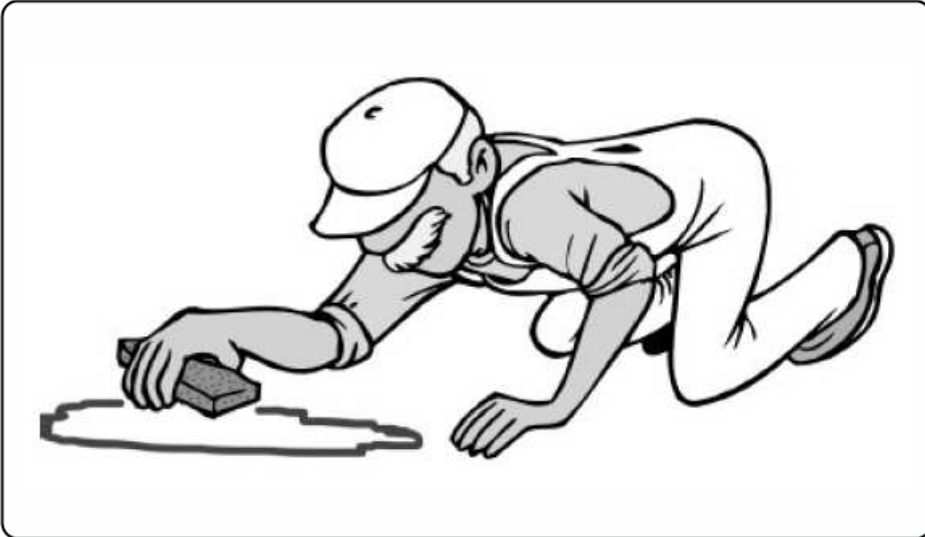

DESCRIPTION:

Practices to clean-up leakage/spillage of on-site materials that may be harmful to receiving waters.

APPLICATION:

- ▶ All sites

GENERAL:

- ▶ Store controlled materials within a storage area.
- ▶ Educate personnel on prevention and clean-up techniques.
- ▶ Designate an Emergency Coordinator responsible for employing preventative practices and for providing spill response.
- ▶ Maintain a supply of clean-up equipment on-site and post a list of local response agencies with phone numbers.

METHODS:

- ▶ Clean-up spills/leaks immediately and remediate cause.
- ▶ Use as little water as possible. NEVER HOSE DOWN OR BURY SPILL CONTAMINATED MATERIAL.
- ▶ Use rags or absorbent material for clean-up. Excavate contaminated soils. Dispose of clean-up material and soil as hazardous waste.
- ▶ Document all spills with date, location, substance, volume, actions taken and other pertinent data.
- ▶ Contact local Fire Department and State Division of Environmental Response and Remediation (Phone #536-4100) for any spill of reportable quantity.

OBJECTIVES

- Housekeeping Practices
- Contain Waste
- Minimize Disturbed Areas
- Stabilize Disturbed Areas
- Protect Slopes/Channels
- Control Site Perimeter
- Control Internal Erosion



WEBER COUNTY

ENGINEERING DEPARTMENT

2380 Washington Blvd., Suite 240
Ogden, UT 84401
(801) 399-8374

TARGETED POLLUTANTS

- Sediment
- Nutrients
- Toxic Materials
- Oil & Grease
- Floatable Materials
- Other Construction Waste

- High Impact
- Medium Impact
- Low or Unknown Impact

IMPLEMENTATION REQUIREMENTS

- Capital Costs
- O&M Costs
- Maintenance
- Training

- High
- Medium
- Low

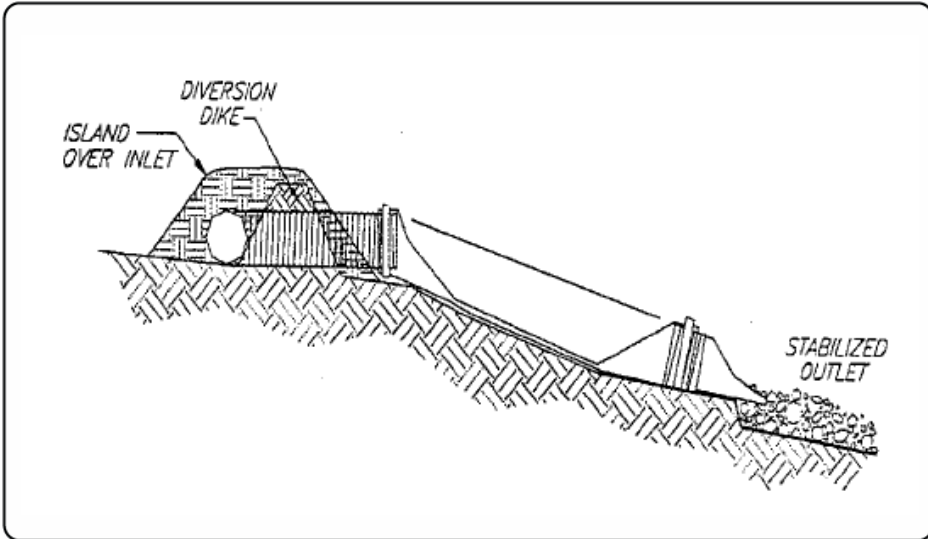

DESCRIPTION:

A temporary pipe or lined channel that drains the top of a slope to a stable discharge point at the bottom of a slope without causing erosion.

APPLICATIONS:

- ▶ Where concentrated flow of surface runoff must be conveyed down a slope in order to prevent erosion.
- ▶ Drainage for top slope diversion dikes or swales.
- ▶ Emergency spillway for a sediment basin.
- ▶ Drainage for top of cut/fill slopes where water can accumulate.

INSTALLATION/APPLICATION CRITERIA:

- ▶ Secure inlet and surround with dikes to prevent gully erosion, and anchor pipe to slope.
- ▶ Size to convey at least the peak of a 10-year, storm event.
- ▶ Stabilize outlet. (See Outlet Protection BMP).

LIMITATIONS:

- ▶ Maximum drainage area per slope drain is 5 acres.
- ▶ Clogged slope drains will force water around the pipe and cause slope erosion.
- ▶ Dissipation of high flow velocities at the pipe outlet is required to avoid downstream erosion.
- ▶ Failure can result in flooding and severe erosion.

MAINTENANCE:

- ▶ Structure must be inspected weekly and after storms.
- ▶ Inlet must be free of undercutting and no water should circumvent the entry.
- ▶ Outlet should not produce erosion; velocity dissipators must be maintained.
- ▶ Pipe anchors must be checked to ensure that the pipe remains anchored to the slope.

OBJECTIVES

- Housekeeping Practices
- Contain Waste
- Minimize Disturbed Areas
- Stabilize Disturbed Areas
- Protect Slopes/Channels
- Control Site Perimeter
- Control Internal Erosion



WEBER COUNTY

ENGINEERING DEPARTMENT

2380 Washington Blvd., Suite 240
Ogden, UT 84401
(801) 399-8374

TARGETED POLLUTANTS

- Sediment
- Nutrients
- Toxic Materials
- Oil & Grease
- Floatable Materials
- Other Waste

- High Impact
- Medium Impact
- Low or Unknown Impact

IMPLEMENTATION REQUIREMENTS

- Capital Costs
- O&M Costs
- Maintenance
- Training

- High
- Medium
- Low

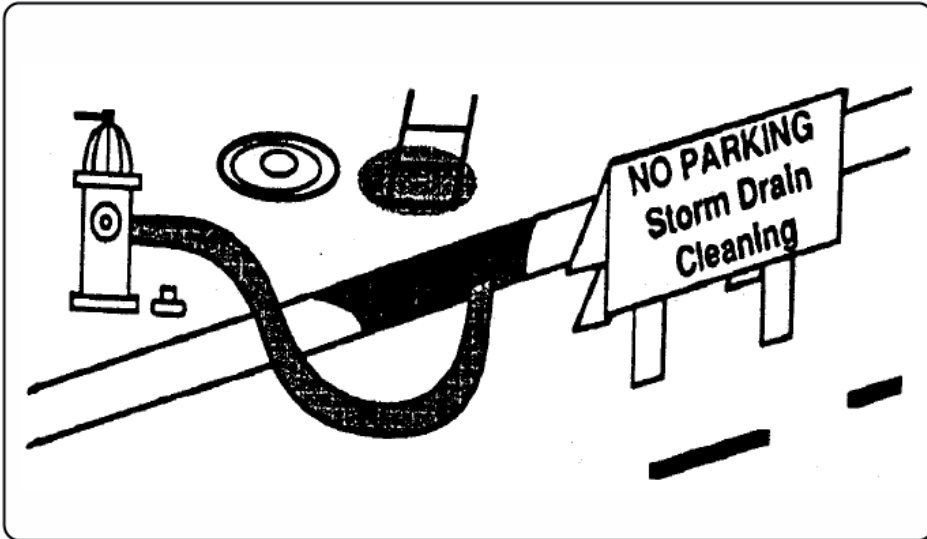

OBJECTIVES

- New Development
- Residential
- Commercial Activities
- Industrial Activities
- Municipal Facilities
- Illegal Discharges



WEBER COUNTY

ENGINEERING DEPARTMENT

2380 Washington Blvd., Suite 240
 Ogden, UT 84401
 (801) 399-8374

DESCRIPTION:

- ▶ A storm drain is “flushed” with water to suspend and remove deposited materials. Flushing is particularly beneficial for storm drain pipes with grades too flat to be self cleansing. Flushing helps ensure pipes convey design flow and remove pollutants from the storm drain system.

APPROACH:

- ▶ Locate reaches of storm drain with deposit problems and develop a flushing schedule that keeps the pipe clear of excessive buildup.
- ▶ Whenever possible, flushed effluent should be collected, decanted, evaporated, and disposed of in a landfill.

LIMITATIONS:

- ▶ Most effective in small diameter pipes (36-inch diameter pipe or less, depending on water supply and sediment collection capacity).
- ▶ Water source must be available.
- ▶ May have difficulty finding downstream area to collect sediments.
- ▶ Requires liquid/sediment disposal.

TARGETED POLLUTANTS

- Sediment
- Nutrients
- Heavy Metals
- Toxic Materials
- Oxygen Demanding Substance
- Oil & Grease
- Floatable Materials
- Bacteria & Viruses
- High Impact
- Medium Impact
- Low or Unknown Impact

IMPLEMENTATION REQUIREMENTS

- Capital Costs
- O&M Costs
- Regulatory
- Training
- Staffing
- Administrative
- High
- Medium
- Low



DESCRIPTION:

Stenciling of the storm drain system (inlets, catch basins, channels, and creeks) with prohibitive language/graphic icons discourages the illegal dumping of unwanted materials.

APPROACH:

- ▶ Create a volunteer work force to stencil storm drain inlets.
- ▶ An important aspect of a stenciling program is the distribution of informational flyers that educate the neighborhood (business and residential) about stormwater pollution, the storm drain system, and the watershed. The flyers should also provide information on alternatives such as recycling, household hazardous waste disposal, and safer products.
- ▶ Because a stenciling program primarily involves volunteer services, liability release forms and volunteer identification notices should also be administered.
- ▶ Readability of stencils is critical to their effectiveness. Wherever possible stencils should be painted on a smooth surface such as cement, as opposed to asphalt.
- ▶ Use municipal staff to erect signs near drainage channels and creeks.
- ▶ An effectively implemented stenciling program encourages change in personal behavior and helps minimize non-point source pollutants from entering the storm drain system. An additional benefit is that waste and catch basin maintenance is minimized through the reduction of disposed materials into storm drain inlets. Finally a well-implemented stenciling program encourages the use of household hazardous waste collection and used oil recycling programs.

LIMITATIONS:

- ▶ Private property access limits stenciling to publicly-owned areas.
- ▶ Program is highly dependent on volunteer response.
- ▶ Storm drain inlets that are physically blocked will be missed or require follow-up.
- ▶ High traffic/commercial/industrial zones are the responsibility of city staff.
- ▶ Ongoing maintenance is needed to maintain readable signs.

OBJECTIVES

- New Development
- Residential
- Commercial Activities
- Industrial Activities
- Municipal Facilities
- Illegal Discharges



WEBER COUNTY

ENGINEERING DEPARTMENT

2380 Washington Blvd., Suite 240
Ogden, UT 84401
(801) 399-8374

TARGETED POLLUTANTS

- Sediment
- Nutrients
- Heavy Metals
- Toxic Materials
- Oxygen Demanding Substance
- Oil & Grease
- Floatable Materials
- Bacteria & Viruses
- High Impact
- Medium Impact
- Low or Unknown Impact

IMPLEMENTATION REQUIREMENTS

- Capital Costs
- O&M Costs
- Regulatory
- Training
- Staffing
- Administrative
- High
- Medium
- Low

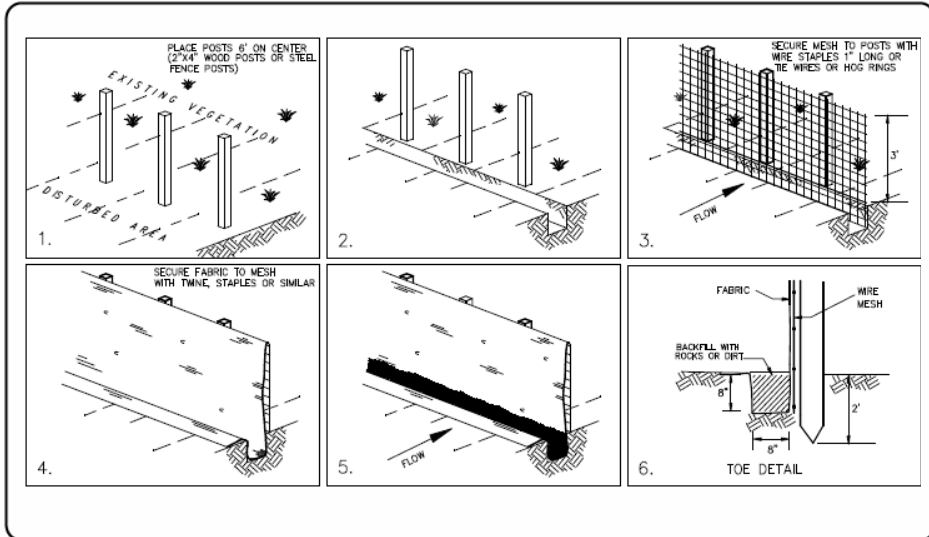

DESCRIPTION:

- ▶ A temporary sediment barrier consisting of entrenched filter fabric stretched across and secured to supporting posts.

APPLICATION:

- ▶ Perimeter control: place barrier at downgradient limits of disturbance
- ▶ Sediment barrier: place barrier at toe of slope or soil stockpile
- ▶ Protection of existing waterways: place barrier at top of stream bank
- ▶ Inlet protection: place fence surrounding catchbasins

INSTALLATION/APPLICATION CRITERIA:

- ▶ Place posts 6 feet apart on center along contour (or use preassembled unit) and drive 2 feet minimum into ground. Excavate an anchor trench immediately upgradient of posts.
- ▶ Secure wire mesh (14 gage min. With 6 inch openings) to upslope side of posts. Attach with heavy duty 1 inch long wire staples, tie wires or hog rings.
- ▶ Cut fabric to required width, unroll along length of barrier and drape over barrier. Secure fabric to mesh with twine, staples, or similar, with trailing edge extending into anchor trench.
- ▶ Backfill trench over filter fabric to anchor.

LIMITATIONS:

- ▶ Recommended maximum drainage area of 0.5 acre per 100 feet of fence
- ▶ Recommended maximum upgradient slope length of 150 feet
- ▶ Recommended maximum uphill grade of 2:1 (50%)
- ▶ Recommended maximum flow rate of 0.5 cfs
- ▶ Ponding should not be allowed behind fence

MAINTENANCE:

- ▶ Inspect immediately after any rainfall and at least daily during prolonged rainfall.
- ▶ Look for runoff bypassing ends of barriers or undercutting barriers.
- ▶ Repair or replace damaged areas of the barrier and remove accumulated sediment.
- ▶ Reanchor fence as necessary to prevent shortcutting.
- ▶ Remove accumulated sediment when it reaches ½ the height of the fence.

OBJECTIVES

- Housekeeping Practices
- Contain Waste
- Minimize Disturbed Areas
- Stabilize Disturbed Areas
- Protect Slopes/Channels
- Control Site Perimeter
- Control Internal Erosion



WEBER COUNTY

ENGINEERING DEPARTMENT

2380 Washington Blvd., Suite 240
Ogden, UT 84401
(801) 399-8374

TARGETED POLLUTANTS

- Sediment
- Nutrients
- Toxic Materials
- Oil & Grease
- Floatable Materials
- Other Waste

- High Impact
- Medium Impact
- Low or Unknown Impact

IMPLEMENTATION REQUIREMENTS

- Capital Costs
- O&M Costs
- Maintenance
- Training

- High
- Medium
- Low



OBJECTIVES

- Manufacturing
- Material Handling
- Vehicle Maintenance
- Construction
- Commercial Activities
- Roadways
- Waste Containment
- Housekeeping Practices

DESCRIPTION:

Signs and labels identify problem areas or hazardous materials at a facility. Warning signs, often found at industrial facilities, are a good way to suggest caution in certain areas. Signs and labels can also provide instructions on the use of materials and equipment. Labeling is a good way to organize large amounts of materials, pipes, and equipment, particularly on large sites.

APPROACH:

Signs and labels can be used at all types of facilities. Areas where they are particularly useful are material transfer areas, equipment areas, loading and unloading areas, or anywhere information might prevent contaminants from being released to stormwater.

Signs and labels should be visible and easy to read. Useful signs and labels might provide the following information:

- ▶ Names of facility and regulatory personnel, including emergency phone numbers, to contact in case of an accidental discharge, spill, or other emergency.
- ▶ Proper uses of equipment that could cause release of stormwater contaminants.
- ▶ Types of chemicals used in high-risk areas.
- ▶ The direction of drainage lines/ditches and their destination (treatment or discharge).
- ▶ Information on a specific material.
- ▶ Refer to OSHA standards for sizes and numbers of signs required for hazardous material labeling.

LIMITATIONS:

- ▶ No limitations.

MAINTENANCE:

- ▶ Periodic checks can ensure that signs are still in place and labels are properly attached.
- ▶ Signs and labels should be replaced and repaired as often as necessary.



WEBER COUNTY

ENGINEERING DEPARTMENT

2380 Washington Blvd., Suite 240
Ogden, UT 84401
(801) 399-8374

TARGETED POLLUTANTS

- Sediment
- Nutrients
- Heavy Metals
- Toxic Materials
- Oxygen Demanding Substance
- Oil & Grease
- Floatable Materials
- Bacteria & Viruses
- High Impact
- Medium Impact
- Low or Unknown Impact

IMPLEMENTATION REQUIREMENTS

- Capital Costs
- O&M Costs
- Maintenance
- Training
- High
- Medium
- Low

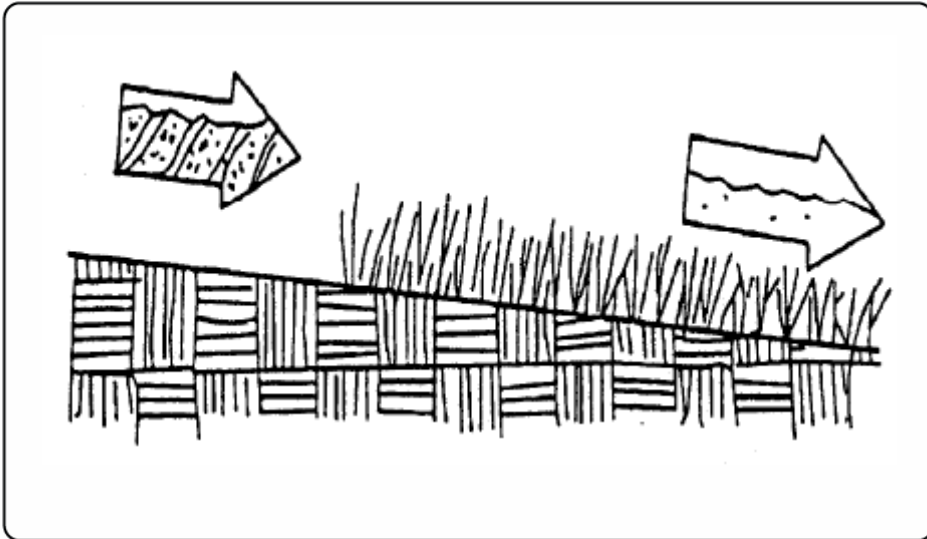

DESCRIPTION:

- ▶ Seeding of grass and plantings of trees, shrubs, vines and ground covers provide long-term stabilization of soil. In some areas, with suitable climates, grasses can be planted for temporary stabilization.

APPLICATION:

- ▶ Appropriate for site stabilization both during and after construction
- ▶ Any graded/cleared areas where construction activities have ceased.
- ▶ Open space cut and fill areas.
- ▶ Steep slopes, spoil piles, vegetated swales, landscape corridors, stream banks.

INSTALLATION/APPLICATION CRITERIA:

Type of vegetation, site and seedbed preparation, planting time, fertilization and water requirements should be considered for each application. Grasses:

- ▶ Ground preparation: fertilize and mechanically stabilize the soil.
- ▶ Tolerant of short-term temperature extremes and waterlogged soil composition.
- ▶ Appropriate soil conditions: shallow soil base, good drainage, slope 2:1 or flatter.
- ▶ Mowing, irrigating, and fertilizing are vital for promoting vigorous grass growth.

Trees and Shrubs:

- ▶ Selection criteria: vigor, species, size, shape & wildlife food source.
- ▶ Soil conditions: select species appropriate for soil, drainage & acidity.
- ▶ Other factors: wind/exposure, temperature extremes, and irrigation needs.

Vines and Ground Covers:

- ▶ Ground preparation: lime and fertilizer preparation.
- ▶ Use proper seeding rates.
- ▶ Appropriate soil conditions: drainage, acidity and slopes.
- ▶ Generally avoid species requiring irrigation.

LIMITATIONS:

- ▶ Permanent and temporary vegetation may not be appropriate in dry periods without irrigation.
- ▶ Fertilizer requirements may have potential to create stormwater pollution.

MAINTENANCE:

- ▶ Shrubs and trees must be adequately watered and fertilized and if needed pruned.
- ▶ Grasses may need to be watered and mowed.

OBJECTIVES

- Housekeeping Practices
- Contain Waste
- Minimize Disturbed Areas
- Stabilize Disturbed Areas
- Protect Slopes/Channels
- Control Site Perimeter
- Control Internal Erosion



WEBER COUNTY

ENGINEERING DEPARTMENT

2380 Washington Blvd., Suite 240
Ogden, UT 84401
(801) 399-8374

TARGETED POLLUTANTS

- Sediment
- Nutrients
- Toxic Materials
- Oil & Grease
- Floatable Materials
- Other Waste

- High Impact
- Medium Impact
- Low or Unknown Impact

IMPLEMENTATION REQUIREMENTS

- Capital Costs
- O&M Costs
- Maintenance
- Training

- High
- Medium
- Low

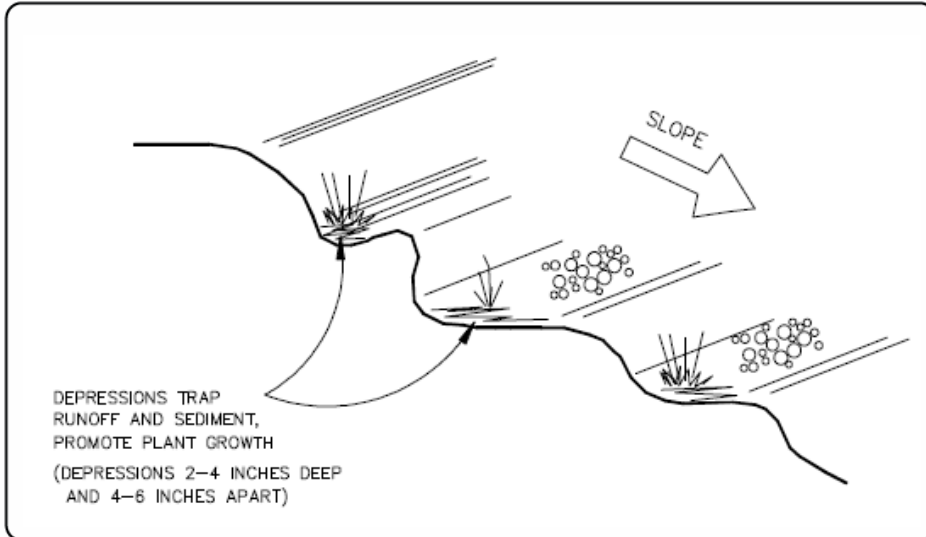

DESCRIPTION:

Rough preparation of working areas leaving depressions and uneven surface. Depressions should be done parallel to contours.

APPLICATION:

- ▶ Surface roughening is appropriate for all construction that will not be receiving impervious cover within 14 days and that will be exposed less than 60 days (seed areas to be open in excess of 60 days).

INSTALLATION/APPLICATION CRITERIA:

- ▶ Surface should be left in rough condition during initial earthwork activity.
- ▶ Surfaces that have become smoothed or compacted due to equipment traffic should be roughened by use of disks, spring harrows, teeth on front end loader, or similar, operating along the contours of the slope. Tracking (by crawler tractor driving up and down slope) may also be used to provide depressions parallel to contours.
- ▶ Avoid compaction of soils during roughening as this inhibits plant growth and promotes storm water runoff. Limit tracked machinery to sandy soil.
- ▶ Seed or mulch areas to be exposed in excess of 60 days.
- ▶ Employ dust controls. (See Dust Control Detail Sheet).

LIMITATIONS:

- ▶ Will not withstand heavy rainfall.
- ▶ Slopes steeper than 2:1 (50%) should be benched. (See Benching Detail Sheet).

MAINTENANCE:

- ▶ Inspect following any storm event and at a minimum of weekly.
- ▶ If erosion in the form of rills (small waterways formed by runoff) is evident, perform machine roughening of area.
- ▶ For vegetated slopes reseed areas that are bare or have been reworked.

OBJECTIVES

- Housekeeping Practices
- Contain Waste
- Minimize Disturbed Areas
- Stabilize Disturbed Areas
- Protect Slopes/Channels
- Control Site Perimeter
- Control Internal Erosion



WEBER COUNTY

ENGINEERING DEPARTMENT

2380 Washington Blvd., Suite 240
Ogden, UT 84401
(801) 399-8374

TARGETED POLLUTANTS

- Sediment
- Nutrients
- Toxic Materials
- Oil & Grease
- Floatable Materials
- Other Waste

- High Impact
- Medium Impact
- Low or Unknown Impact

IMPLEMENTATION REQUIREMENTS

- Capital Costs
- O&M Costs
- Maintenance
- Training

- High
- Medium
- Low

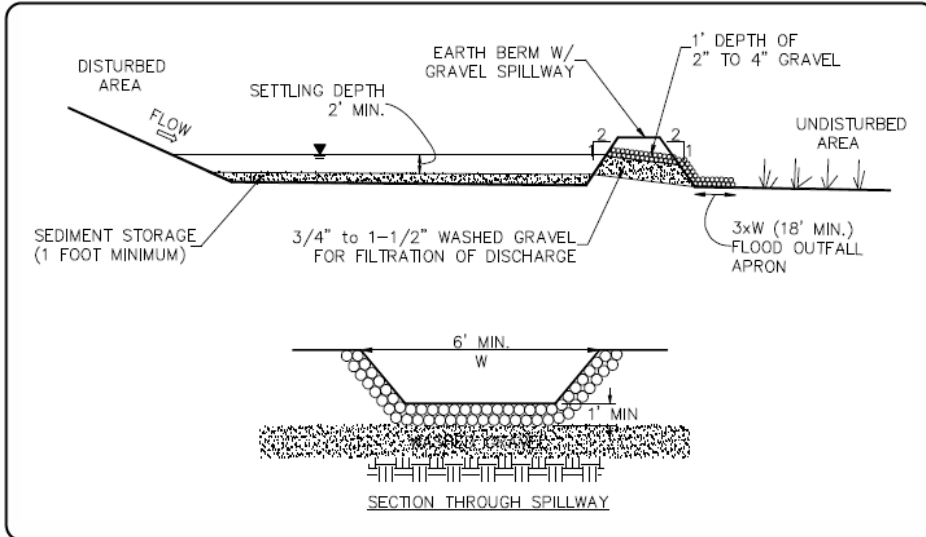

DESCRIPTION:

A sediment trap is a small excavated or bermed area where runoff from small drainage areas is detained and sediment can settle.

APPLICATION:

- ▶ Temporary control for runoff from disturbed areas of less than 3 acres.
- ▶ Temporary control for discharge from diversion dike, surface benching, or other temporary drainage measures.

INSTALLATION/APPLICATION CRITERIA:

- ▶ Design basin for site specific location.
- ▶ Excavate basin or construct compacted berm containment.
- ▶ Construct outfall spillway with apron.
- ▶ Provide downstream silt fence if necessary.

LIMITATIONS:

- ▶ Should be sized based on anticipated runoff, sediment loading and drainage area size.
- ▶ May require silt fence at outlet for entrapment of very fine silts and clays.

MAINTENANCE:

- ▶ Inspect after each rainfall event and at a minimum of monthly.
- ▶ Repair any damage to berm, spillway or sidewalls.
- ▶ Remove accumulated sediment as it reaches 2/3 height of available storage.
- ▶ Check outlet for sedimentation/erosion of downgradient area and remediate as necessary. Install silt fence if sedimentation apparent.

OBJECTIVES

- Housekeeping Practices
- Contain Waste
- Minimize Disturbed Areas
- Stabilize Disturbed Areas
- Protect Slopes/Channels
- Control Site Perimeter
- Control Internal Erosion



WEBER COUNTY

ENGINEERING DEPARTMENT

2380 Washington Blvd., Suite 240
Ogden, UT 84401
(801) 399-8374

TARGETED POLLUTANTS

- Sediment
- Nutrients
- Toxic Materials
- Oil & Grease
- Floatable Materials
- Other Waste

- High Impact
- Medium Impact
- Low or Unknown Impact

IMPLEMENTATION REQUIREMENTS

- Capital Costs
- O&M Costs
- Maintenance
- Training

- High
- Medium
- Low

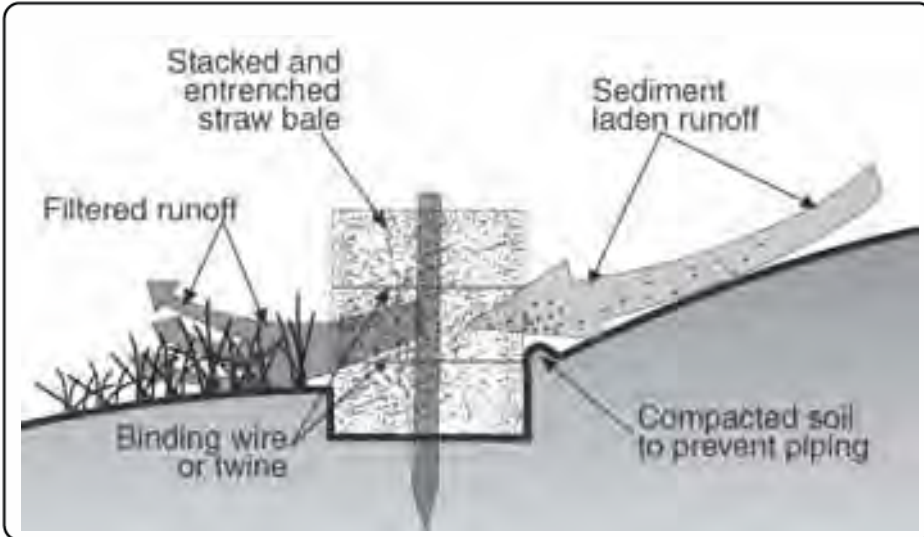

DESCRIPTION:

Temporary sediment barrier consisting of a row of entrenched and anchored straw bales.

APPLICATION:

- ▶ Perimeter Control: place barrier at downgradient limits of disturbance.
- ▶ Sediment barrier: place barrier at toe of slope or soil stockpile.
- ▶ Protection of existing waterways: place barrier at top of stream bank.
- ▶ Inlet Protection.

INSTALLATION/APPLICATION CRITERIA:

- ▶ Excavate a 4-inch minimum deep trench along contour line, i.e. parallel to slope, removing all grass and other material that may allow underflow.
- ▶ Place bales in trench with ends tightly abutting; fill any gaps by wedging loose straw into openings.
- ▶ Anchor each bale with 2 stakes driven flush with the top of the bale.
- ▶ Backfill around bale and compact to prevent piping, backfill on uphill side to be built up 4-inches above ground at the barrier.

LIMITATIONS:

- ▶ Recommended maximum area of 0.5 acre per 100 feet of barrier
- ▶ Recommended maximum upgradient slope length of 150 feet
- ▶ Recommended maximum uphill grade of 2:1 (50%)

MAINTENANCE:

- ▶ Inspect immediately after any rainfall and at least daily during prolonged rainfall.
- ▶ Look for runoff bypassing ends of barriers or undercutting barriers.
- ▶ Repair or replace damaged areas of the barrier and remove accumulated sediment.
- ▶ Realign bales as necessary to provide continuous barrier and fill gaps.
- ▶ Recompress soil around barrier as necessary to prevent piping.

OBJECTIVES

- Housekeeping Practices
- Contain Waste
- Minimize Disturbed Areas
- Stabilize Disturbed Areas
- Protect Slopes/Channels
- Control Site Perimeter
- Control Internal Erosion



WEBER COUNTY

ENGINEERING DEPARTMENT

2380 Washington Blvd., Suite 240
Ogden, UT 84401
(801) 399-8374

TARGETED POLLUTANTS

- Sediment
- Nutrients
- Toxic Materials
- Oil & Grease
- Floatable Materials
- Other Waste

- High Impact
- Medium Impact
- Low or Unknown Impact

IMPLEMENTATION REQUIREMENTS

- Capital Costs
- O&M Costs
- Maintenance
- Training

- High
- Medium
- Low

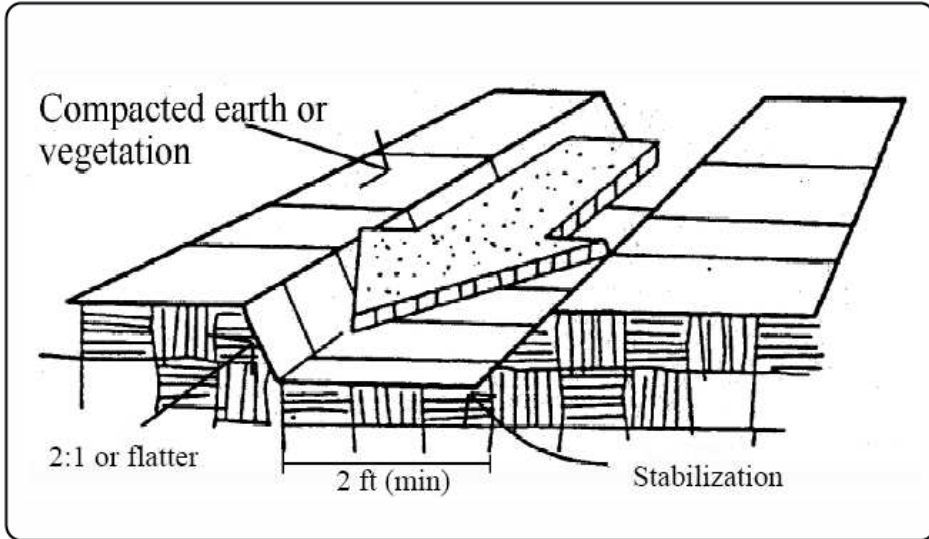

DESCRIPTION:

Temporary drains and swales are used to divert off-site runoff around the construction site, divert runoff from stabilized areas around disturbed areas, and direct runoff into sediment.

APPLICATIONS:

- ▶ Temporary drains and swales are appropriate for diverting any upslope runoff around unstabilized or disturbed areas of the construction site.
- ▶ Prevent slope failures. Prevent damage to adjacent property. Prevents erosion and transport of sediments into water ways. Increases the potential for infiltration. Diverts sediment-laden runoff into sediment basins or traps.

INSTALLATION/APPLICATION:

- ▶ Temporary drainage swales will effectively convey runoff and avoid erosion if built properly:
- ▶ Size temporary drainage swales using local drainage design criteria. A permanent drainage channel must be designed by a professional engineer (see the local drainage design criteria for proper design).
- ▶ At a minimum, the drain/swale should conform to predevelopment drainage patterns and capacities.
- ▶ Construct the drain/swale with an uninterrupted, positive grade to a stabilized outlet. Provide erosion protection or energy dissipation measures if the flow out of the drain or swale can reach an erosive velocity.

LIMITATIONS:

- ▶ Temporary drains and swales or any other diversion of runoff should not adversely impact upstream or downstream properties.
- ▶ Temporary drains and swales must conform to local floodplain management requirements.

MAINTENANCE:

- ▶ Inspect weekly and after each rain.
- ▶ Repair any erosion immediately.
- ▶ Remove sediment which builds up in the swale and restricts its flow capacity.

OBJECTIVES

- Housekeeping Practices
- Contain Waste
- Minimize Disturbed Areas
- Stabilize Disturbed Areas
- Protect Slopes/Channels
- Control Site Perimeter
- Control Internal Erosion



WEBER COUNTY

ENGINEERING DEPARTMENT

2380 Washington Blvd., Suite 240
Ogden, UT 84401
(801) 399-8374

TARGETED POLLUTANTS

- Sediment
- Nutrients
- Toxic Materials
- Oil & Grease
- Floatable Materials
- Other Waste

- High Impact
- Medium Impact
- Low or Unknown Impact

IMPLEMENTATION REQUIREMENTS

- Capital Costs
- O&M Costs
- Maintenance
- Training

- High
- Medium
- Low



DEFINITION:

- ▶ Temporary seeding - establishment of short term cover by application of rapidly germinating seed mix (alternatively hydroseeding may be utilized).
- ▶ Permanent seeding - establishment of final term cover by application of perennial seed mix (alternatively sod may be utilized).

APPLICATION:

- ▶ Disturbed areas that are at final grade and which will not be disturbed by continuing activities on site. Also areas that are not at final grade but which will be left untouched in excess of one year.

LIMITATIONS:

- ▶ Limited to areas that will not be subject to traffic or high usage.
- ▶ May require irrigation and fertilizer which creates potential for impacting runoff quality.
- ▶ May only be applied during appropriate planting season, temporary cover required until that time.

INSTALLATION:

- ▶ Roughen soil to a depth of 2 inches. Add fertilizer, manure, topsoil as necessary.
- ▶ Evenly distribute seed using a commonly accepted method such as; breast seeding, drilling, hydroseeding.
- ▶ Use a seed mix appropriate for soil and location that will provide rapid germination and growth. Check with County for recommended mix and application rate.
- ▶ Cover area with mulch if required due to steep slopes or unsuitable weather conditions.

MAINTENANCE:

- ▶ Provide irrigation as required to establish growth and to maintain plant cover through duration of project.
- ▶ Reseed as necessary to provide 75% coverage
- ▶ Remediate any areas damaged by erosion or traffic.
- ▶ When 75% coverage is achieved inspect monthly for damage and remediate as necessary.

OBJECTIVES

- Housekeeping Practices
- Contain Waste
- Minimize Disturbed Areas
- Stabilize Disturbed Areas
- Protect Slopes/Channels
- Control Site Perimeter
- Control Internal Erosion



WEBER COUNTY

ENGINEERING DEPARTMENT

2380 Washington Blvd., Suite 240
Ogden, UT 84401
(801) 399-8374

TARGETED POLLUTANTS

- Sediment
- Nutrients
- Toxic Materials
- Oil & Grease
- Floatable Materials
- Other Waste

- High Impact
- Medium Impact
- Low or Unknown Impact

IMPLEMENTATION REQUIREMENTS

- Capital Costs
- O&M Costs
- Maintenance
- Training

- High
- Medium
- Low

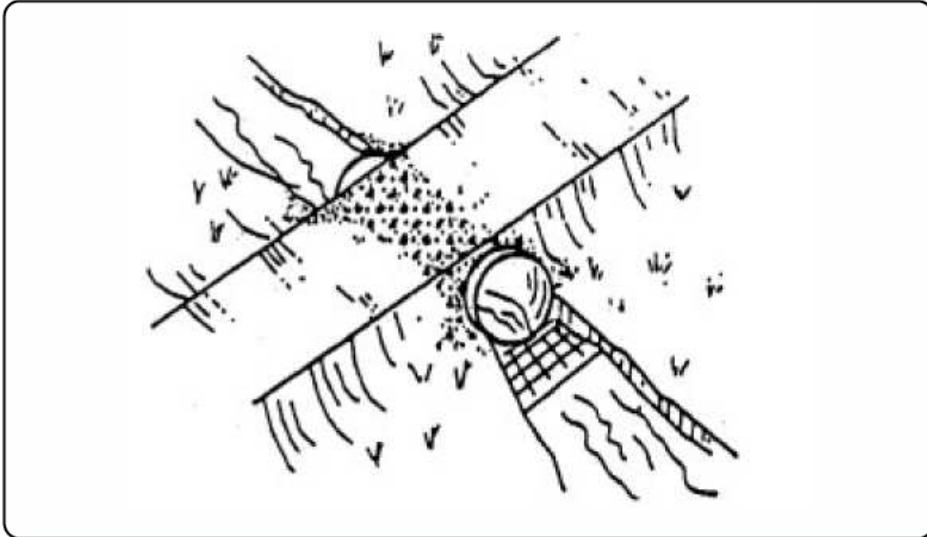

DESCRIPTION:

A temporary access stream crossing is a temporary culvert, ford or bridge placed across a waterway to provide access for construction purposes for a period of less than one year. Temporary access crossings are not intended to be used to maintain traffic for the general public.

APPLICATIONS:

- ▶ Temporary stream crossings should be installed at all designated crossings of perennial and intermittent streams on the construction site, as well as for dry channels which may be significantly eroded by construction traffic.

INSTALLATION/APPLICATION:

- ▶ Requires knowledge of stream flows and soil strength and should be designed under the direction of a Utah registered engineer with knowledge of both hydraulics and construction loading requirements for structures.

LIMITATIONS:

- ▶ May be an expensive for a temporary improvement.
- ▶ Requires other BMPs to minimize soil disturbance during installation and removal.
- ▶ Fords should only be used in dry weather.
- ▶ A Stream Alteration Permit may be required, contact the Utah Division of Water Rights before implementation.

MAINTENANCE:

- ▶ Inspect weekly and after each significant rainfall, including assessment of foundations.
- ▶ Periodically remove silt from crossings.
- ▶ Replace lost aggregated from inlets and outlets of culverts.

OBJECTIVES

- Housekeeping Practices
- Contain Waste
- Minimize Disturbed Areas
- Stabilize Disturbed Areas
- Protect Slopes/Channels
- Control Site Perimeter
- Control Internal Erosion



WEBER COUNTY

ENGINEERING DEPARTMENT

2380 Washington Blvd., Suite 240
Ogden, UT 84401
(801) 399-8374

TARGETED POLLUTANTS

- Sediment
- Nutrients
- Toxic Materials
- Oil & Grease
- Floatable Materials
- Other Waste

- High Impact
- Medium Impact
- Low or Unknown Impact

IMPLEMENTATION REQUIREMENTS

- Capital Costs
- O&M Costs
- Maintenance
- Training

- High
- Medium
- Low

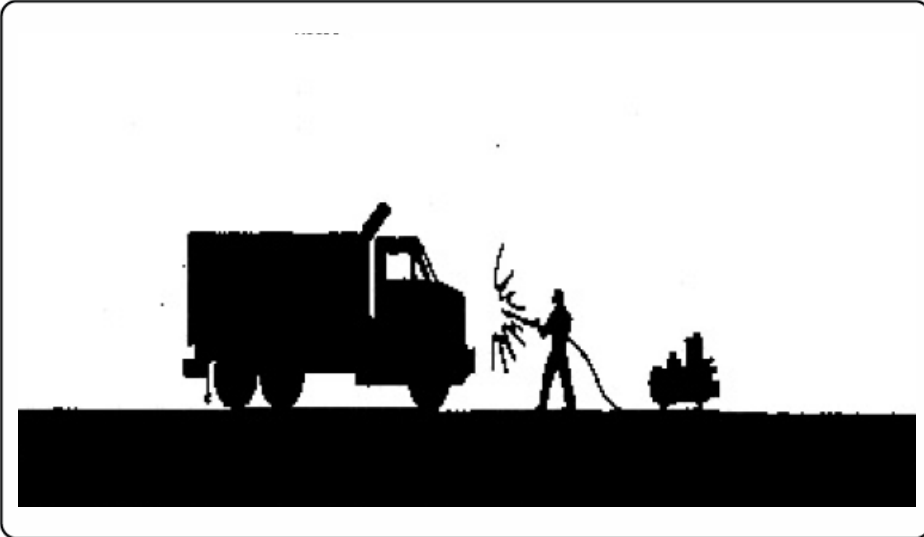

DESCRIPTION:

Prevent or reduce the discharge of pollutants to stormwater from vehicle and equipment washing and steam cleaning by using off-site facilities, washing in designated, contained areas only, eliminating discharges to the storm drain by infiltrating or recycling the wash water, and training employees and subcontractors.

APPROACH:

- ▶ Use off-site commercial washing and steam cleaning businesses as much as possible. Washing vehicles and equipment outdoors or in areas where wash water flows onto paved surfaces or into drainage pathways can pollute stormwater. If you wash a large number of vehicles or pieces of equipment, consider conducting this work at an off-site commercial business. These businesses are better equipped to handle and dispose of the wash waters properly. Performing this work off-site can also be economical by eliminating the need for a separate washing operation at your site.
- ▶ If washing must occur on-site, use designated, bermed wash areas to prevent wash water contact with stormwater, creeks, rivers, and other water bodies. The wash area can be sloped for wash water collection and subsequent infiltration into the ground.
- ▶ Use as little water as possible to avoid having to install erosion and sediment controls for the wash area. Use phosphate-free biodegradable soaps. Educate employees and subcontractors on pollution prevention measures. Do not permit steam cleaning on-site. Steam cleaning can generate significant pollutant concentrations.

LIMITATIONS:

- ▶ Even phosphate-free, biodegradable soaps have been shown to be toxic to fish before the soap degrades.
- ▶ Sending vehicles/equipment off-site should be done in conjunction with Stabilized Construction Entrance. (See BMP in the Construction Section).
- ▶ The measures outlined in this fact sheet are insufficient to address all the environmental impacts and compliance issues related to steam cleaning.

MAINTENANCE:

- ▶ Minimal, some berm repair may be necessary.

OBJECTIVES

- Manufacturing
- Material Handling
- Vehicle Maintenance
- Construction
- Commercial Activities
- Roadways
- Waste Containment
- Housekeeping Practices



WEBER COUNTY

ENGINEERING DEPARTMENT

2380 Washington Blvd., Suite 240
Ogden, UT 84401
(801) 399-8374

TARGETED POLLUTANTS

- Sediment
- Nutrients
- Heavy Metals
- Toxic Materials
- Oxygen Demanding Substance
- Oil & Grease
- Floatable Materials
- Bacteria & Viruses
- High Impact
- Medium Impact
- Low or Unknown Impact

IMPLEMENTATION REQUIREMENTS

- Capital Costs
- O&M Costs
- Maintenance
- Training
- High
- Medium
- Low

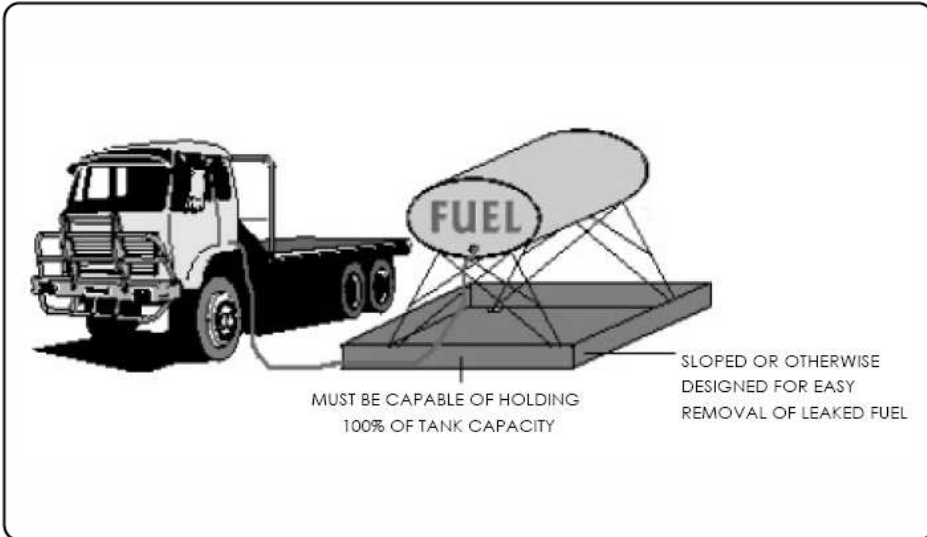

OBJECTIVES

- Manufacturing
- Material Handling
- Vehicle Maintenance
- Construction
- Commercial Activities
- Roadways
- Waste Containment
- Housekeeping Practices



WEBER COUNTY

ENGINEERING DEPARTMENT

2380 Washington Blvd., Suite 240
Ogden, UT 84401
(801) 399-8374

DESCRIPTION:

Prevent fuel spills and leaks, and reduce their impacts to stormwater by using off-site facilities, fueling in designated areas only, enclosing or covering stored fuel, implementing spill controls, and training employees and subcontractors.

APPROACH:

- ▶ Use off-site fueling stations as much as possible. Fueling vehicles and equipment outdoors or in areas where fuel may spill/leak onto paved surfaces or into drainage pathways can pollute stormwater. If you fuel a large number of vehicles or pieces of equipment, consider using an off-site fueling station. These businesses are better equipped to handle fuel and spills properly. Performing this work off-site can also be economical by eliminating the need for a separate fueling area at your site.
- ▶ If fueling must occur on-site, use designated areas, located away from drainage courses, to prevent the runoff of stormwater and the runoff of spills.
- ▶ Discourage "topping-off" of fuel tanks.
- ▶ Always use secondary containment, such as a drain pan or drop cloth, when fueling to catch spills/leaks. Place a stockpile of spill cleanup materials where it will be readily accessible. Use adsorbent materials on small spills rather than hosing down or burying the spill. Remove the adsorbent materials promptly and dispose of properly.
- ▶ Carry out all federal and state requirements regarding stationary above ground storage tanks. Avoid mobile fueling of mobile construction equipment around the site; rather, transport the equipment to designated fueling areas. With the exception of tracked equipment such as bulldozers and perhaps forklifts, most vehicles should be able to travel to a designated area with little lost time. Train employees and subcontractors in proper fueling and cleanup procedures.

LIMITATIONS:

- ▶ Sending vehicles/equipment off-site should be done in conjunction with Stabilized Construction Entrance (See BMP sheet in Construction section).

MAINTENANCE:

- ▶ Keep ample supplies of spill cleanup materials on-site.
- ▶ Inspect fueling areas and storage tanks on a regular schedule.

TARGETED POLLUTANTS

- Sediment
- Nutrients
- Heavy Metals
- Toxic Materials
- Oxygen Demanding Substance
- Oil & Grease
- Floatable Materials
- Bacteria & Viruses
- High Impact
- Medium Impact
- Low or Unknown Impact

IMPLEMENTATION REQUIREMENTS

- Capital Costs
- O&M Costs
- Maintenance
- Training
- High
- Medium
- Low

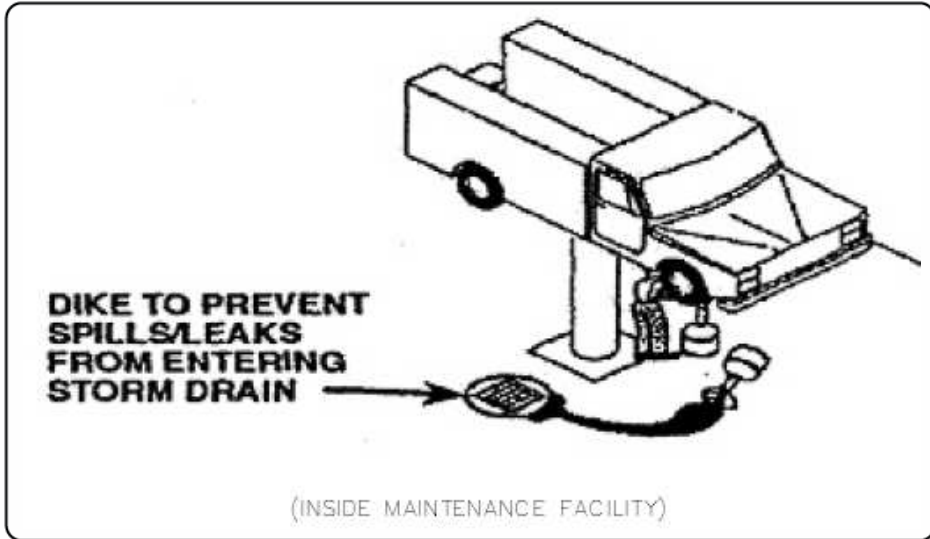

DESCRIPTION:

Prevent or reduce the discharge of pollutants to stormwater from vehicles and equipment maintenance and repair by running a dry shop.

APPROACH:

- ▶ Keep equipment clean; don't allow excessive build-up of oil and grease.
- ▶ Keep drip pans or containers under the areas that might drip.
- ▶ Do not change motor oil or perform equipment maintenance in non-appropriate areas.
- ▶ Inspect equipment for leaks on a regular basis.
- ▶ Segregate wastes.
- ▶ Make sure oil filters are completely drained and crushed before recycling or disposal.
- ▶ Make sure incoming vehicles are checked for leaking oil and fluids.
- ▶ Clean yard storm drain inlets regularly and especially after large storms.
- ▶ Do not pour materials down drains or hose down work areas; use dry seeping.
- ▶ Store idle equipment under cover.
- ▶ Drain all fluids from wrecked vehicles.
- ▶ Recycle greases, used oil or oil filters, antifreeze, cleaning solutions, automotive batteries, hydraulic, and transmission fluids.
- ▶ Switch to non-toxic chemicals for maintenance when possible.
- ▶ Clean small spills with rags, general clean-up with damp mops and larger spills with absorbent material.
- ▶ Paint signs on storm drain inlets to indicate that they are not to receive liquid or solid wastes.
- ▶ Train employees, minimize use of solvents.

LIMITATIONS:

- ▶ Space and time limitations may preclude all work being conducted indoors.
- ▶ It may not be possible to contain and clean up spills from vehicles/equipment brought on-site after working hours.
- ▶ Dry pans are generally too small to contain antifreeze, which may gush from some vehicles, so drip pans may have to be purchased or fabricated.
- ▶ Dry floor cleaning methods may not be sufficient for some spills.

MAINTENANCE:

- ▶ Should be low if procedures for the approach are followed.

OBJECTIVES

- Manufacturing
- Material Handling
- Vehicle Maintenance
- Construction
- Commercial Activities
- Roadways
- Waste Containment
- Housekeeping Practices



WEBER COUNTY

ENGINEERING DEPARTMENT

2380 Washington Blvd., Suite 240
Ogden, UT 84401
(801) 399-8374

TARGETED POLLUTANTS

- Sediment
- Nutrients
- Heavy Metals
- Toxic Materials
- Oxygen Demanding Substance
- Oil & Grease
- Floatable Materials
- Bacteria & Viruses
- High Impact
- Medium Impact
- Low or Unknown Impact

IMPLEMENTATION REQUIREMENTS

- Capital Costs
- O&M Costs
- Maintenance
- Training
- High
- Medium
- Low



OBJECTIVES

- Manufacturing
- Material Handling
- Vehicle Maintenance
- Construction
- Commercial Activities
- Roadways
- Waste Containment
- Housekeeping Practices



WEBER COUNTY

ENGINEERING DEPARTMENT

2380 Washington Blvd., Suite 240
Ogden, UT 84401
(801) 399-8374

DESCRIPTION:

Prevent or reduce the discharge of pollutants to stormwater from waste handling and disposal by tracking waste generation, storage, and disposal; reducing waste generation and disposal through source reduction, re-use, and recycling; and preventing runoff and runoff from waste management areas.

APPROACH:

- ▶ Maintain usage inventory to limit waste generation.
- ▶ Substitute or eliminate raw materials.
- ▶ Modify process or equipment.
- ▶ SARA Title III, Section 313 requires reporting for over 300 listed chemicals and chemical compounds. This requirement should be used to track these chemicals although this is not as accurate a means of tracking as other approaches.
- ▶ Track waste generated.
- ▶ Use design data and review: process flow diagram, materials and applications diagram, piping and instructions, equipment list, plot plan.
- ▶ Use economic data and review: Waste treatment and disposal cost. Product utility and economic cost. Operation and maintenance labor cost.
- ▶ Recycle materials whenever possible.
- ▶ Maintain list of and the amounts of materials disposed.
- ▶ Segregation and separate waste.
- ▶ Cover, enclose, or berm industrial wastewater management areas whenever possible to prevent contact with runoff or runoff.
- ▶ Equip waste transport vehicles with anti-spill equipment.
- ▶ Minimize spills and fugitive losses such as dust or mist from loading systems.
- ▶ Ensure that sediments or wastes are prevented from being tracked off-site.
- ▶ Training and supervision.
- ▶ Stencil storm drains on the facility's property with prohibitive message regarding waste disposal.

LIMITATIONS:

- ▶ Hazardous waste that cannot be re-used or recycled must be disposed of by a licensed hazardous waste hauler.

TARGETED POLLUTANTS

- Sediment
- Nutrients
- Heavy Metals
- Toxic Materials
- Oxygen Demanding Substance
- Oil & Grease
- Floatable Materials
- Bacteria & Viruses
- High Impact
- Medium Impact
- Low or Unknown Impact

IMPLEMENTATION REQUIREMENTS

- Capital Costs
- O&M Costs
- Maintenance
- Training
- High
- Medium
- Low