

Appendix A: SWPPP Template – Utah

Instructions

To help you develop the narrative section of your construction site SWPPP, the DWQ has modified the U.S Environmental Protection Agency (EPA) electronic SWPPP template to fit the needs of NOI applicants in Utah. The template is designed to help guide you through the SWPPP development process and help ensure that your SWPPP addresses all the necessary elements stated in your construction general permit. It may be helpful to use this template with EPA’s guidance on *Developing Your Stormwater Pollution Prevention Plan*. Both are available on EPA’s website at www.epa.gov/npdes/swpppguide

This template covers most of the SWPPP elements that the Utah construction general permit requires, however, you are strongly encouraged to customize this template. There are two major reasons to customize this template:

- **To reflect the terms and conditions of the State construction general permit; and**
- **To reflect the conditions at your site**

Using the SWPPP Template

Each section of this template includes “instructions” and space for project information. You should read the instructions for each section before you complete that section. This template was developed in Word so that you can easily add tables and additional text. Some sections may require only a brief description while others may require several pages of explanation.

Tips for completing the SWPPP template

- If there is more than one construction operator for your project, consider coordinating development of your SWPPP with the other operators.
- Multiple operators may share the same SWPPP, but make sure that responsibilities are clearly described.
- Modify this SWPPP template so that it addresses the requirements in your construction general permit and meets the needs of your project. Consider adding permit citations in the SWPPP when you address a specific permit requirement.

Stormwater Pollution Prevention Plan

for:

SC119 Nudd
4684 N Abbey Way
Eden, UT 84310

Operator(s):

Lifestyle Homes
Chris Funk
45 N Main Ste 101
Logan, UT 84321
435-363-0100
chris@buildwithlifestyle.com

SWPPP Contact(s):

Lifestyle Homes
Jeremy Wilcock, Chris Funk
45 N Main Ste 101
Logan, UT 84321
435-363-0100
jeremy@buildwithlifestyle.com
chris@buildwithlifestyle.com

SWPPP Preparation Date:

10/30/2013

Estimated Project Dates:

Project Start Date: 11/04/2013
Project Completion Date: 04/15/2014

Contents

SECTION 1: SITE EVALUATION, ASSESSMENT, AND PLANNING	1
1.1 Project/Site Information.....	1
1.2 Contact Information/Responsible Parties	2
1.3 Nature and Sequence of Construction Activity	3
1.4 Soils, Slopes, Vegetation, and Current Drainage Patterns.....	4
1.5 Construction Site Estimates	5
1.6 Receiving Waters.....	5
1.7 Site Features and Sensitive Areas to be Protected.....	6
1.8 Potential Sources of Pollution.....	6
1.9 Endangered Species Certification.....	7
1.10 Historic Preservation.....	8
1.11 Applicable Federal, Tribal, State or Local Programs	8
1.12 Maps.....	9
SECTION 2: EROSION AND SEDIMENT CONTROL BMPS.....	10
2.1 Minimize Disturbed Area and Protect Natural Features and Soil.....	11
2.2 Phase Construction Activity	11
2.3 Control Stormwater Flowing onto and through the Project.....	12
2.4 Stabilize Soils.....	12
2.5 Protect Slopes.....	13
2.6 Protect Storm Drain Inlets	13
2.7 Establish Perimeter Controls and Sediment Barriers.....	14
2.8 Retain Sediment On-Site.....	14
2.9 Establish Stabilized Construction Exits	15
2.10 Additional BMPs	16
SECTION 3: GOOD HOUSEKEEPING BMPS	17
3.1 Material Handling and Waste Management	17
3.2 Establish Proper Building Material Staging Areas	18
3.3 Designate Washout Areas	18
3.4 Establish Proper Equipment/Vehicle Fueling and Maintenance Practices	19
3.5 Control Equipment/Vehicle Washing	19
3.6 Spill Prevention and Control Plan.....	20
3.7 Any Additional BMPs	20
3.8 Allowable Non-Stormwater Discharge Management.....	21
SECTION 4: SELECTING POST-CONSTRUCTION BMPS	23
SECTION 5: INSPECTIONS.....	24
5.1 Inspections	24
5.2 Delegation of Authority	25
5.3 Corrective Action Log	25
SECTION 6: RECORDKEEPING AND TRAINING	26
6.1 Recordkeeping	26
6.2 Log of Changes to the SWPPP	26
6.3 Training.....	27
SECTION 7: FINAL STABILIZATION.....	28

SECTION 8: CERTIFICATION AND NOTIFICATION.....	29
SWPPP APPENDICES	30
Appendix A – General Location Map	
Appendix B – Site Maps	
Appendix C – Construction General Permit	
Appendix D – NOI and Acknowledgement Letter from EPA/State	
Appendix E – Inspection Reports	
Appendix F – Corrective Action Log (or in Part 5.3)	
Appendix G – SWPPP Amendment Log (or in Part 6.2)	
Appendix H – Subcontractor Certifications/Agreements	
Appendix I – Grading and Stabilization Activities Log (or in Part 6.1)	
Appendix J – Training Log	
Appendix K – Delegation of Authority	
Appendix L – Additional Information (i.e., Endangered Species and Historic Preservation Documentation; other permits such as dewatering, stream alteration, wetland; and out of date SWPPP documents)	
Appendix M – BMP Specifications	

SECTION 1: SITE EVALUATION, ASSESSMENT, AND PLANNING CERTIFICATION, AND SIGNATURE

1.1 Project/Site Information

□

Instructions:

- In this section, you can gather some basic site information that will be helpful to you later when you file for permit coverage.
- For more information, see *Developing Your Stormwater Pollution Prevention Plan: A SWPPP Guide for Construction Sites* (also known as the *SWPPP Guide*), Chapter 2
- Detailed information on determining your site's latitude and longitude can be found at www.epa.gov/npdes/stormwater/latlong

Project/Site Name: SC119 Nudd

Project Street/Location: 4684 N Abbey Way

City: Eden State: UT ZIP Code: 84310

County or Similar Subdivision: WEBER COUNTY

Latitude/Longitude (Use **one** of three possible formats, and specify method)

Latitude:

1. ° ' " N (degrees, minutes, seconds)
2. ° ' " N (degrees, minutes, decimal)
3. 41.042778 ° N (decimal)

Longitude:

1. ° ' " W (degrees, minutes, seconds)
2. ° ' " W (degrees, minutes, decimal)
3. 111.089722 ° W (decimal)

Method for determining latitude/longitude:

- USGS topographic map (specify scale: _____) EPA Web site GPS
 Other (please specify): Google Earth

Is the project located in Indian country? Yes No

If yes, name of Reservation, or if not part of a Reservation, indicate "not applicable." _____

Is this project considered a federal facility? Yes No

UPDES project or permit tracking number*: UTR365583

**(This is the unique identifying number assigned to your project by your permitting authority after you have applied for coverage under the appropriate National Pollutant Discharge Elimination System (UPDES) construction general permit.)*

1.2 Contact Information/Responsible Parties

□

Instructions:

- List the operator(s), project managers, stormwater contact(s), and person or organization that prepared the SWPPP. Indicate respective responsibilities, where appropriate.
- Also, list subcontractors expected to work on-site. Notify subcontractors of stormwater requirements applicable to their work.
- See *SWPPP Guide*, Chapter 2.B.

Operator(s):

Lifestyle Homes
Jeremy Wilcock
45 N Main Ste 101
Logan, UT 84321
435-757-1087
Jeremy@buildwithlifestyle.com

Project Manager(s) or Site Supervisor(s):

Lifestyle Homes
Chris Funk
45 N Main Ste 101
Logan, UT 84321
435-994-2253
chris@buildwithlifestyle.com

SWPPP Contact(s):

Lifestyle Homes
Chris Funk
45 N Main Ste 101
Logan, UT 84321
435-994-2253
chris@buildwithlifestyle.com

This SWPPP was Prepared by:

Lifestyle Homes
Jeremy Wilcock
45 N Main Ste 101 435-363-0100
Logan, UT 84321 jeremy@buildwithlifestyle.com

Subcontractor(s):

Legrand Johnson
Blaine Bingham
PO Box 248
Logan, UT 84321
435-752-2000
blaine@ljcc.com

Funk Brothers
Tyler Funk
PO Box 75
Wellsville, UT
435-512-3579
genevafunk@aol.com

Coombs Plumbing
Matt Coombs
321 E 100 N
Hyrum, UT 84319
435-512-3538
coombsplumber@hotmail.com

Emergency 24-Hour Contact:

Lifestyle Homes
Chris Funk
435-994-2253

1.3 Nature and Sequence of Construction Activity

□

Instructions:

- Briefly describe the nature of the construction activity and approximate time frames (one or more paragraphs, depending on the nature and complexity of the project).
- For more information, see *SWPPP Guide*, Chapter 3.A.

Describe the general scope of the work for the project, major phases of construction, etc:

New construction of a residential house. Phases of construction include, pre-construction/planning phase, structural phase, 4-way phase, prep for paint phase, interior finish

phase, and closing phase.

What is the function of the construction activity?

- Residential Commercial Industrial Road Construction Linear Utility
 Other (please specify):

Estimated Project Start Date: 11/04/2013

Estimated Project Completion Date: 04/15/2014

1.4 Soils, Slopes, Vegetation, and Current Drainage Patterns

□

Instructions:

- Describe the existing soil conditions at the construction site including soil types, slopes and slope lengths, drainage patterns, and other topographic features that might affect erosion and sediment control.
- Also, note any historic site contamination evident from existing site features and known past usage of the site.
- This information should also be included on your site maps (See *SWPPP Guide*, Chapter 3.C.).
- For more information, see *SWPPP Guide*, Chapter 3.A.

Soil type(s):

Native soil that is sand and rock

Slopes (describe current slopes and note any changes due to grading or fill activities):

Slope is from front of lot to rear (west to east) and light slope from north to south

Drainage Patterns (describe current drainage patterns and note any changes dues to grading or fill activities):

Current drainage pattern is west to east and from north to south. Drainage patterns are not planned to change after grading activities

Vegetation:

Native weeds and trees

1.5 Construction Site Estimates

Instructions:

- Estimate the area to be disturbed by excavation, grading, or other construction activities, including dedicated off-site borrow and fill areas.
- Calculate the percentage of impervious surface area before and after construction
- Calculate the runoff coefficients before and after construction.
- For more information, see *SWPPP Guide*, Chapter 3.A and Appendix C.

The following are estimates of the construction site.

Total project area:	0.4 acres
Construction site area to be disturbed:	0.2 acres
Percentage impervious area before construction:	0%
Runoff coefficient before construction:	.1
Percentage impervious area after construction:	23.3%
Runoff coefficient after construction: See site construction drawings for details	.524

1.6 Receiving Waters

Instructions:

- List the waterbody(s) that would receive stormwater from your site, including streams, rivers, lakes, coastal waters, and wetlands. Describe each as clearly as possible, such as Big Cottonwood Creek, a tributary to the Jordan River, and so on.
- Indicate the location of all waters, including wetlands, on the site map.
- Note any stream crossings, if applicable.
- List the storm sewer system or drainage system that stormwater from your site could discharge to and the waterbody(s) that it ultimately discharges to.
- If any of the waterbodies above are impaired and/or subject to Total Maximum Daily Loads (TMDLs), please list the pollutants causing the impairment and any specific requirements in the TMDL(s) that are applicable to construction sites. Your SWPPP should specifically include measures to prevent the discharge of these pollutants.
- For more information, see *SWPPP Guide*, Chapter 3.A and 3.B.
- Also, for more information and a list of TMDL contacts and links by state, visit www.epa.gov/npdes/stormwater/tmdl.

Description of receiving waters:

Pine View Reservoir

Description of storm sewer systems:

Surface drainage via gutters

Description of unique features that are to be preserved:

N/A

Describe measures to protect these features:

N/A

Description of impaired waters or waters subject to TMDLs:

Other:

1.7 Site Features and Sensitive Areas to be Protected

□

Instructions:

- Describe unique site features including streams, stream buffers, wetlands, specimen trees, natural vegetation, steep slopes, or highly erodible soils that are to be preserved.
- Describe measures to protect these features.
- Include these features and areas on your site maps.
- For more information, see *SWPPP Guide*, Chapter 3.A and 3.B.

1.8 Potential Sources of Pollution

□

Instructions:

- Identify and list all potential sources of sediment, which may reasonably be expected to affect the quality of stormwater discharges from the construction site.
- Identify and list all potential sources of pollution, other than sediment, which may reasonably be expected to affect the quality of stormwater discharges from the construction site.
- For more information, see *SWPPP Guide*, Chapter 3.A.

Potential sources of sediment to stormwater runoff:

[Grading, excavation, material delivery & storage](#)

Potential pollutants and sources, other than sediment, to stormwater runoff:

Trade Name Material	Stormwater Pollutants	Location
Concrete washout, structure construction, material delivery		

Material delivery, storage & use	Oil & grease	
Concrete washout, painting, cleaning, sanitary waste	pH (acids & bases)	
Concrete washout, construction, painting, material delivery, solid waste disposal	Trash, debris and solids	

1.9 Endangered Species Certification

□

Instructions:

- Before beginning construction, determine whether endangered or threatened species or their critical habitats are on or near your site. For help to determine this you may wish to call the Dept of Natural Resources, Div. of Wildlife Resources at 801-538-4700 or call US Fish & Wildlife at 801-975-3330.
- Adapt this section as needed for state or tribal endangered species requirements and, if applicable, document any measures deemed necessary to protect endangered or threatened species or their critical habitats.
- For more information on this topic, see *SWPPP Guide*, Chapter 3.B.
- Additional information on Endangered Species Act (ESA) provisions is at www.epa.gov/npdes/stormwater/esa

Are endangered or threatened species and critical habitats on or near the project area?

Yes No

Describe how this determination was made:

[Visual inspection](#)

If yes, describe the species and/or critical habitat:

If yes, describe or refer to documentation that determines the likelihood of an impact on identified species and/or habitat and the steps taken to address that impact. (Note, if species are on or near your project site, EPA strongly recommends that the site operator work closely with the appropriate field office of the U.S. Fish and Wildlife Service or National Marine Fisheries Service. For concerns related to state or tribal listing of species, please contact a state or tribal official.)

1.10 Historic Preservation

□

Instructions:

- Before you begin construction, you should review federal and any applicable state, local, or tribal historic preservation laws and determine if there are historic sites on or near your project. If so, you might need to make adjustments to your construction plans or to your stormwater controls to ensure that these historic sites are not damaged. For help with Utah Historic Property and Antiquities you may wish to call 801-533-3535.
- For more information, see *SWPPP Guide*, Chapter 3.B or contact your state or tribal historic preservation

Are there any historic sites on or near the construction site?

Yes No

Describe how this determination was made:

[No historic sites on property.](#)

If yes, describe or refer to documentation that determines the likelihood of an impact on this historic site and the steps taken to address that impact.

1.11 Applicable Federal, Tribal, State or Local Programs

□

Instructions:

- Note other applicable federal, tribal, state or local soil and erosion control and stormwater management requirements that apply to your construction site.

[N/A](#)

1.12 Maps

□

Instructions:

- Attach site maps. For most projects, a series of site maps is recommended. The first should show the undeveloped site and its current features. An additional map or maps should be created to show the developed site or for more complicated sites show the major phases of development.

These maps should include the following:

- Direction(s) of stormwater flow and approximate slopes before and after major grading activities;
- Areas and timing of soil disturbance;
- Areas that will not be disturbed;
- Natural features to be preserved;
- Locations of major structural and non-structural BMPs identified in the SWPPP;
- Locations and timing of stabilization measures;
- Locations of off-site material, waste, borrow, or equipment storage areas;
- Locations of all waters of the United States, including wetlands;
- Locations where stormwater discharges to a surface water;
- Locations of storm drain inlets; and
- Areas where final stabilization has been accomplished.
- For more information, see *SWPPP Guide*, Chapter 3.C.

Include the site maps with the SWPPP.

SECTION 2: EROSION AND SEDIMENT CONTROL BMPS

□

Instructions:

- Describe the BMPs that will be implemented to control pollutants in stormwater discharges. For each major activity identified, do the following
 - ✓ Clearly describe appropriate control measures.
 - ✓ Describe the general sequence during the construction process in which the measures will be implemented.
 - ✓ Describe the maintenance and inspection procedures that will be used for that specific BMP.
 - ✓ Include protocols, thresholds, and schedules for cleaning, repairing, or replacing damaged or failing BMPs.
 - ✓ Identify staff responsible for maintaining BMPs.
 - ✓ (If your SWPPP is shared by multiple operators, indicate the operator responsible for each BMP.)
- Categorize each BMP under one of the following 10 areas of BMP activity as described below:
 - 2.1 *Minimize disturbed area and protect natural features and soil*
 - 2.2 *Phase Construction Activity*
 - 2.3 *Control Stormwater flowing onto and through the project*
 - 2.4 *Stabilize Soils*
 - 2.5 *Protect Slopes*
 - 2.6 *Protect Storm Drain Inlets*
 - 2.7 *Establish Perimeter Controls and Sediment Barriers*
 - 2.8 *Retain Sediment On-Site and Control Dewatering Practices*
 - 2.9 *Establish Stabilized Construction Exits*
 - 2.10 *Any Additional BMPs*
- Note the location of each BMP on your site map(s).
- For any structural BMPs, you should provide design specifications and details and refer to them. Attach them as appendices to the SWPPP or within the text of the SWPPP.
- For more information, see *SWPPP Guide*, Chapter 4.
- Consult your state's design manual or one of those listed in Appendix D of the *SWPPP Guide*.
- For more information or ideas on BMPs, see EPA's National Menu of BMPs
<http://www.epa.gov/hpdes/stormwater/menuofbmps>

2.1 *Minimize Disturbed Area and Protect Natural Features and Soil*

- Instructions:
 - Describe the areas that will be disturbed with each phase of construction and the methods (e.g., signs, fences) that you will use to protect those areas that should not be disturbed. Describe natural features identified earlier and how each will be protected during construction activity. Also describe how topsoil will be preserved. Include these areas and associated BMPs on your site map(s) also. (For more information, see *SWPPP Guide*, Chapter 4, ESC Principle 1.)
 - Also, see EPA's *Preserving Natural Vegetation BMP Fact Sheet* at www.epa.gov/npdes/stormwater/menuofbmps/construction/preserve_veg

Soil will be piled in close proximity to the original excavation hole and will be used to backfill the foundation.

2.2 *Phase Construction Activity*

- Instructions:
 - Describe the intended construction sequencing and timing of major activities, including any opportunities for phasing grading and stabilization activities to minimize the overall amount of disturbed soil that will be subject to potential erosion at one time. Also, describe opportunities for timing grading and stabilization so that all or a majority of the soil disturbance occurs during a time of year with less erosion potential (i.e., during the dry or less windy season). (For more information, see *SWPPP Guide*, Chapter 4, ESC Principle 2.) It might be useful to develop a separate, detailed site map for each phase of construction.
 - Also, see EPA's *Construction Sequencing BMP Fact Sheet* at http://www.epa.gov/npdes/stormwater/menuofbmps/construction/cons_seq)
- Phase I
 - Structural phase – excavation, footings, foundation, backfill
 - Approximately 16 business days
 - Silt fence or dirt berm, 3" gravel for truck cleanout, maintained access and exit
- Phase II
 - 4-way phase – framing, HVAC, plumbing, electrical
 - Approximately 20 business days
 - Silt fence or dirt berm, 3" gravel for truck clean out, maintained access and exit
- Phase III
 - Prep for paint phase – insulation, drywall, hard flooring, finish work
 - Approximately 20 business days
 - Silt fence or dirt berm, 3" gravel for truck clean out, maintained access and exit

- Phase IV
 - Interior finish phase
 - Approximately 20 days
 - Silt fence or dirt berm, 3" gravel for truck clean out, maintained access and exit

2.3 Control Stormwater Flowing onto and through the Project

- Instructions:
 - Describe structural practices (e.g., diversions, berms, ditches, storage basins) including design specifications and details used to divert flows from exposed soils, retain or detain flows, or otherwise limit runoff and the discharge of pollutants from exposed areas of the site. (For more information, see SWPPP Guide, Chapter 4, ESC Principle 3.)

BMP Description: Earth berm barrier or silt fence to control stormwater	
Installation Schedule:	Barrier will be installed during excavation
Maintenance and Inspection:	As construction begins a berm or silt fence will be installed, maintenance will be repaired as needed
Responsible Staff:	Chris Funk

2.4 Stabilize Soils

- Instructions:
 - Describe controls (e.g., interim seeding with native vegetation, hydroseeding) to stabilize exposed soils where construction activities have temporarily or permanently ceased. Also describe measures to control dust generation. Avoid using impervious surfaces for stabilization whenever possible. (For more information, see SWPPP Guide, Chapter 4, ESC Principle 4.)
 - Also, see EPA's Seeding BMP Fact Sheet at www.epa.gov/npdes/stormwater/menuofbmps/construction/seeding

BMP Description:	
<input type="checkbox"/> Permanent	<input checked="" type="checkbox"/> Temporary
Installation Schedule:	Berm will be down hill of area to be controlled
Maintenance and Inspection:	Soil will be piled in close proximity to the original excavation hole and will be used to backfill the foundation.
Responsible Staff:	Chris Funk

2.5 Protect Slopes

□

Instructions:

- Describe controls (e.g., erosion control blankets, tackifiers) including design specifications and details that will be implemented to protect all slopes. (For more information, see *SWPPP Guide*, Chapter 4, ESC Principle 5.)
- Also, see EPA's *Geotextiles BMP Fact Sheet* at www.epa.gov/npdes/stormwater/menuofbmps/construction/geotextiles

BMP Description: Compaction

<i>Installation Schedule:</i>	As slopes are disturbed
<i>Maintenance and Inspection:</i>	There is little slope on project, but if needed compaction will be used to stabilize soils
<i>Responsible Staff:</i>	Chris Funk

2.6 Protect Storm Drain Inlets

□

Instructions:

- Describe controls (e.g., inserts, rock-filled bags, or block and gravel) including design specifications and details that will be implemented to protect all inlets receiving stormwater from the project during the entire project. (For more information, see *SWPPP Guide*, Chapter 4, ESC Principle 6.)
- Also, see EPA's *Storm Drain Inlet Protection BMP Fact Sheet* at www.epa.gov/npdes/stormwater/menuofbmps/construction/storm_drain

BMP Description: Inlet protection

<i>Installation Schedule:</i>	As construction is near inlets
<i>Maintenance and Inspection:</i>	Inlet protection to keep storm drains clear
<i>Responsible Staff:</i>	Chris Funk

2.7 Establish Perimeter Controls and Sediment Barriers

□

Instructions:

- Describe structural practices (e.g., silt fences or fiber rolls) including design specifications and details to filter and trap sediment before it leaves the construction site. (For more information, see *SWPPP Guide*, Chapter 4, ESC Principle 7.)
- Also see, EPA's *Silt Fence BMP Fact Sheet* at www.epa.gov/npdes/stormwater/menuofbmps/construction/silt_fences, or *Fiber Rolls BMP Fact Sheet* at www.epa.gov/npdes/stormwater/menuofbmps/construction/fiber_rolls

BMP Description: Silt fence or Earth Berm Barrier

<i>Installation Schedule:</i>	As construction commences
<i>Maintenance and Inspection:</i>	Silt fences or dirt berm will be installed to maintain sediment on site if needed.
<i>Responsible Staff:</i>	Chris Funk

2.8 Retain Sediment On-Site

□

Instructions:

- Describe sediment control practices (e.g., sediment trap or sediment basin), including design specifications and details (volume, dimensions, outlet structure) that will be implemented at the construction site to retain sediments on-site. (For more information, see *SWPPP Guide*, Chapter 4, ESC Principle 8.)
- Also, see EPA's *Sediment Basin BMP Fact Sheet* at www.epa.gov/npdes/stormwater/menuofbmps/construction/sediment_basins

BMP Description: Silt fence or Earth Berm Barrier

<i>Installation Schedule:</i>	As needed during construction
<i>Maintenance and Inspection:</i>	If needed a silt fence or earth berm barrier will be used
<i>Responsible Staff:</i>	Chris Funk

2.9 Establish Stabilized Construction Exits

□

Instructions:

- Describe location(s) of vehicle entrance(s) and exit(s), procedures to remove accumulated sediment off-site (e.g., vehicle tracking), and stabilization practices (e.g., stone pads or wash racks or both) to minimize off-site vehicle tracking of sediments and discharges to stormwater. (For more information, see SWPPP Guide, Chapter 4, ESC Principle 9.)
- Also, see EPA's Construction Entrances BMP Fact Sheet at www.epa.gov/npdes/stormwater/menuofbmps/construction/cons_entrance

BMP Description: Stabilized pad

<i>Installation Schedule:</i>	During construction
<i>Maintenance and Inspection:</i>	Rock stabilized pad for exit of construction site
<i>Responsible Staff:</i>	Chris Funk

BMP Description:

<i>Installation Schedule:</i>	
<i>Maintenance and Inspection:</i>	
<i>Responsible Staff:</i>	

Repeat as needed

2.10 Additional BMPs

□

Instructions:

- Describe additional BMPs that do not fit into the above categories.

BMP Description: None

<i>Installation Schedule:</i>	
<i>Maintenance and Inspection:</i>	
<i>Responsible Staff:</i>	

BMP Description:

<i>Installation Schedule:</i>	
<i>Maintenance and Inspection:</i>	
<i>Responsible Staff:</i>	

[Repeat as needed](#)

SECTION 3: GOOD HOUSEKEEPING BMPS

□

Instructions:

- Describe the key good housekeeping and pollution prevention (P2) BMPs that will be implemented to control pollutants in stormwater.
- Categorize each good housekeeping and pollution prevention (P2) BMP under one of the following seven categories:
 - 3.1 *Material Handling and Waste Management*
 - 3.2 *Establish Proper Building Material Staging Areas*
 - 3.3 *Designate Washout Areas*
 - 3.4 *Establish Proper Equipment/Vehicle Fueling and Maintenance Practices*
 - 3.5 *Allowable Non-Stormwater Discharges and Control Equipment/Vehicle Washing*
 - 3.6 *Spill Prevention and Control Plan*
 - 3.7 *Any Additional BMPs*
- For more information, see *SWPPP Guide*, Chapter 5.
- Consult your state's design manual or resources in Appendix D of the *SWPPP Guide*.
- For more information or ideas on BMPs, see EPA's National Menu of BMPs <http://www.epa.gov/npdes/stormwater/menuofbmps>

3.1 *Material Handling and Waste Management*

□

Instructions:

- Describe measures (e.g., trash disposal, sanitary wastes, recycling, and proper material handling) to prevent the discharge of solid materials to receiving waters, except as authorized by a permit issued under section 404 of the CWA (For more information, see *SWPPP Guide*, Chapter 5, P2 Principle 1.)
- Also, see EPA's *General Construction Site Waste Management BMP Fact Sheet* at www.epa.gov/npdes/stormwater/menuofbmps/construction/cons_wasteman

BMP Description: Dumpster, portable toilet

<i>Installation Schedule:</i>	Beginning of construction
<i>Maintenance and Inspection:</i>	A dumpster will be provided for all debris and refuge. A portable toilet will be provided for sanitary waste.
<i>Responsible Staff:</i>	Chris Funk

<i>BMP Description:</i>	
<i>Installation Schedule:</i>	
<i>Maintenance and Inspection:</i>	
<i>Responsible Staff:</i>	

3.2 Establish Proper Building Material Staging Areas

□

Instructions:

- Describe construction materials expected to be stored on-site and procedures for storage of materials to minimize exposure of the materials to stormwater. (For more information, see SWPPP Guide, Chapter 5, P2 Principle 2.)

<i>BMP Description: Just-in-time ordering</i>	
<i>Installation Schedule:</i>	During construction of buildings
<i>Maintenance and Inspection:</i>	Materials will be ordered just in time to be used to avoid weather damage or theft.
<i>Responsible Staff:</i>	Chris Funk

3.3 Designate Washout Areas

□

Instructions:

- Describe location(s) and controls to eliminate the potential for discharges from washout areas for concrete mixers, paint, stucco, and so on. (For more information, see SWPPP Guide, Chapter 5, P2 Principle 3.)
- Also, see EPA's Concrete Washout BMP Fact Sheet at www.epa.gov/npdes/stormwater/menuofbmps/construction/concrete_wash

<i>BMP Description: Equipment and Vehicle Wash Down Area</i>	
<i>Installation Schedule:</i>	Beginning of construction
<i>Maintenance and Inspection:</i>	3" Rock area will be designated as washout area
<i>Responsible Staff:</i>	Chris Funk

<i>BMP Description:</i>	
<i>Installation Schedule:</i>	
<i>Maintenance and Inspection:</i>	
<i>Responsible Staff:</i>	

Repeat as needed

3.4 Establish Proper Equipment/Vehicle Fueling and Maintenance Practices

- Instructions:
 - Describe equipment/vehicle fueling and maintenance practices that will be implemented to control pollutants to stormwater (e.g., secondary containment, drip pans, and spill kits) (For more information, see SWPPP Guide, Chapter 5, P2 Principle 4.)
 - Also, see EPA's Vehicle Maintenance and Washing Areas BMP Fact Sheet at www.epa.gov/npdes/stormwater/menuofbmps/construction/vehicle_maintain

<i>BMP Description: Vehicle and Equipment Fueling</i>	
<i>Installation Schedule:</i>	During construction
<i>Maintenance and Inspection:</i>	Off-site fueling will be encouraged
<i>Responsible Staff:</i>	Chris Funk

<i>BMP Description:</i>	
<i>Installation Schedule:</i>	
<i>Maintenance and Inspection:</i>	
<i>Responsible Staff:</i>	

Repeat as needed

3.5 Control Equipment/Vehicle Washing

- Instructions:
 - Describe equipment/vehicle washing practices that will be implemented to control pollutants to stormwater. (For more information, see SWPPP Guide, Chapter 5, P2 Principle 5.)
 - Also, see EPA's Vehicle Maintenance and Washing Areas BMP Fact Sheet at www.epa.gov/npdes/stormwater/menuofbmps/construction/vehicle_maintain

<i>BMP Description: Equipment and Vehicle Wash Down Area</i>	
<i>Installation Schedule:</i>	Beginning of construction
<i>Maintenance and Inspection:</i>	3" rock area provided for washout

Responsible Staff:	Chris Funk
BMP Description:	
Installation Schedule:	
Maintenance and Inspection:	
Responsible Staff:	

Repeat as needed

3.6 Spill Prevention and Control Plan

□

Instructions:

- Describe the spill prevention and control plan to include ways to reduce the chance of spills, stop the source of spills, contain and clean up spills, dispose of materials contaminated by spills, and train personnel responsible for spill prevention and control. (For more information, see *SWPPP Guide*, Chapter 5, P2 Principle 6.)
- Also, see EPA's *Spill Prevention and Control Plan BMP Fact sheet* at www.epa.gov/npdes/stormwater/menuofbmps/construction/spill_control

Contacts for any spill are as follows:

- Chris Funk, 435-994-2253: Superintendent on job
- Jeremy Wilcock, 435-757-1087: Production manager on job
- Weber County, 801-399-8374
- Weber-Morgan Health Department 801-399-7100

3.7 Any Additional BMPs

□

Instructions:

- Describe any additional BMPs that do not fit into the above categories. Indicate the problem they are intended to address.

BMP Description: None

<i>Installation Schedule:</i>	
<i>Maintenance and Inspection:</i>	
<i>Responsible Staff:</i>	
<i>BMP Description:</i>	
<i>Installation Schedule:</i>	
<i>Maintenance and Inspection:</i>	
<i>Responsible Staff:</i>	

Repeat as needed

3.8 Allowable Non-Stormwater Discharge Management

-
- Instructions:
- Identify all allowable sources of non-stormwater discharges that are not identified. The allowable non-stormwater discharges identified might include the following (see your permit for an exact list):
 - ✓ Waters used to wash vehicles where detergents are not used
 - ✓ Water used to control dust
 - ✓ Potable water including uncontaminated water line flushings
 - ✓ Routine external building wash down that does not use detergents
 - ✓ Pavement wash waters where spills or leaks of toxic or hazardous materials have not occurred (unless all spilled material has been removed) and where detergents are not used
 - ✓ Uncontaminated air conditioning or compressor condensate
 - ✓ Uncontaminated ground water or spring water
 - ✓ Foundation or footing drains where flows are not contaminated with process materials such as solvents
 - ✓ Uncontaminated excavation dewatering
 - ✓ Landscape irrigation
 - Identify measures used to eliminate or reduce these discharges and the BMPs used to prevent them from becoming contaminated.
 - For more information, see *SWPPP Guide*, Chapter 3.A.

List allowable non-stormwater discharges and the measures used to eliminate or reduce them and to prevent them from becoming contaminated:

<i>BMP Description:</i>	
<i>Installation Schedule:</i>	During construction

<i>Maintenance and Inspection:</i>	Designated washout areas and washing without detergents. All washing will be performed with only water
<i>Responsible Staff:</i>	Chris Funk

<i>BMP Description:</i>	
<i>Installation Schedule:</i>	
<i>Maintenance and Inspection:</i>	
<i>Responsible Staff:</i>	

[Repeat as needed](#)

SECTION 4: SELECTING POST-CONSTRUCTION BMPs

□

Instructions:

- Describe all post-construction stormwater management measures that will be installed during the construction process to control pollutants in stormwater discharges after construction operations have been completed. Examples of post-construction BMPs include the following:
 - ✓ Biofilters
 - ✓ Detention/retention devices
 - ✓ Earth dikes, drainage swales, and lined ditches
 - ✓ Infiltration basins
 - ✓ Porous pavement
 - ✓ Other proprietary permanent structural BMPs
 - ✓ Outlet protection/velocity dissipation devices
 - ✓ Slope protection
 - ✓ Vegetated strips and/or swales
- Identify any applicable federal, state, local, or tribal requirements for design or installation.
- Describe how low-impact designs or smart growth considerations have been incorporated into the design.
- For any structural BMPs, you should have design specifications and details and refer to them. Attach them as appendices to the SWPPP or within the text of the SWPPP.
- For more information on this topic, see your state’s stormwater manual.
- You might also want to consult one of the references listed in Appendix D of the *SWPPP Guide*.
- Visit the post-construction section of EPA’s Menu of BMPs at: www.epa.gov/npes/menuofbmps

BMP Description: Seeding and planting

<i>Installation Schedule:</i>	Post construction of buildings
<i>Maintenance and Inspection:</i>	Landscaped area will be responsibility of homeowner
<i>Responsible Staff:</i>	Homeowner

BMP Description:

<i>Installation Schedule:</i>	
<i>Maintenance and Inspection:</i>	
<i>Responsible Staff:</i>	

Repeat as needed

SECTION 5: INSPECTIONS

5.1 *Inspections*

□

Instructions:

- Identify the individual(s) responsible for conducting inspections and describe their qualifications. Reference or attach the inspection form that will be used.
- Describe the frequency that inspections will occur at your site including any correlations to storm frequency and intensity.
- Note that inspection details for particular BMPs should be included in Sections 2 and 3.
- You should also document the repairs and maintenance that you undertake as a result of your inspections. These actions can be documented in the corrective action log described in Part 5.3 below.
- For more on this topic, see *SWPPP Guide*, Chapters 6 and 8.
- Also, see suggested inspection form in Appendix B of the *SWPPP Guide*.

1. *Inspection Personnel:* Identify the person(s) who will be responsible for conducting inspections and describe their qualifications: Chris Funk, Lifestyle Homes Construction Superintendent

2. *Inspection Schedule and Procedures:*

Describe the inspection schedules and procedures you have developed for your site (include frequency of inspections for each BMP or group of BMPs, indicate when you will inspect, e.g., before/during/and after rain events, spot inspections):

Inspection reports will be performed on a 2 week frequency

Describe the general procedures for correcting problems when they are identified. Include responsible staff and time frames for making corrections:

Staff responsible for corrective actions will be Jeremy Wilcock and Chris Funk. Efforts will be made to correct issues as identified within the terms set by individual who identifies problems.

Attach a copy of the inspection report you will use for your site.

[REFERENCE ATTACHMENT](#)

5.2 Delegation of Authority

□

Instructions:

- Identify the individual(s) or specifically describe the position where the construction site operator has delegated authority for the purposes of signing inspection reports, certifications, or other information.
- Attach the delegation of authority form that will be used.
- For more on this topic, see *SWPPP Guide*, Chapter 7.

Duly Authorized Representative(s) or Position(s):

Lifestyle Homes

Chris Funk

Superintendent

45 North Main, Ste 101

Logan, UT 84321

435-890-2253

chris@buildwithlifestyle.com

Lifestyle Homes

Jeremy Wilcock

Production Manager

45 North Main, Ste 101

Logan, UT 84321

435-757-

jeremy@buildwithlifestyle.com

5.3 Corrective Action Log

□

Instructions:

- Create here, or as an attachment, a corrective action log. This log should describe repair, replacement, and maintenance of BMPs undertaken as a result of the inspections and maintenance procedures described above. Actions related to the findings of inspections should reference the specific inspection report.
- This log should describe actions taken, date completed, and note the person that completed the work.

Corrective Action Log:

[Attachments will be added when corrective actions occur](#)

SECTION 6: RECORDKEEPING AND TRAINING

6.1 Recordkeeping

□

Instructions:

- The following is a list of records you should keep at your project site available for inspectors to review:
- Dates of grading, construction activity, and stabilization (which is covered in Sections 2 and 3)
- A copy of the construction general permit (attach)
- The signed and certified NOI form or permit application form (attach)
- A copy of the letter from EPA or/the state notifying you of their receipt of your complete NOI/application (attach)
- Inspection reports (attach)
- Records relating to endangered species and historic preservation (attach)
- Check your permit for additional details
- For more on this subject, see *SWPPP Guide*, Chapter 6.C.

Records will be retained for a minimum period of at least 3 years after the permit is terminated.

Date(s) when major grading activities occur:

[Plat map to record dates is attached](#)

Date(s) when construction activities temporarily or permanently cease on a portion of the site:

[Plat map to record dates is attached](#)

Date(s) when an area is either temporarily or permanently stabilized:

[Plat map to record dates is attached](#)

6.2 Log of Changes to the SWPPP

□

Instructions:

- Create a log here, or as an attachment, of changes and updates to the SWPPP. You should include additions of new BMPs, replacement of failed BMPs, significant changes in the activities or their timing on the project, changes in personnel, changes in inspection and maintenance procedures, updates to site maps, and so on.

Log of changes and updates to the SWPPP

[Attachments will be added when changes are made to the SWPPP](#)

6.3 Training

□

Instructions:

- Training your staff and subcontractors is an effective BMP. As with the other steps you take to prevent stormwater problems at your site, you should document the training that you conduct for your staff, for those with specific stormwater responsibilities (e.g. installing, inspecting, and maintaining BMPs), and for subcontractors.
- Include dates, number of attendees, subjects covered, and length of training.
- For more on this subject, see *SWPPP Guide*, Chapter 8.

Individual(s) Responsible for Training:

[Jeremy Wilcock](#)

[Chris Funk](#)

Describe Training Conducted:

- General stormwater and BMP awareness training for staff and subcontractors:
- Detailed training for staff and subcontractors with specific stormwater responsibilities:

SECTION 7: FINAL STABILIZATION

□

Instructions:

- Describe procedures for final stabilization. If you complete major construction activities on part of your site, you can document your final stabilization efforts for that portion of the site. Many permits will allow you to then discontinue inspection activities in these areas (be sure to check your permit for exact requirements). You can amend or add to this section as areas of your project are finally stabilized.
- Update your site plans to indicate areas that have achieved final stabilization.
- Note that dates for areas that have achieved final stabilization should be included in Section 6, Part 6.1 of this SWPPP.
- For more on this topic, see *SWPPP Guide*, Chapter 9.

BMP Description: Seeding and Planting

<i>Installation Schedule:</i>	Post construction
<i>Maintenance and Inspection:</i>	Final stabilization will be achieved through landscaping and vegetation by homeowner after occupancy
<i>Responsible Staff:</i>	Homeowner

BMP Description:

<i>Installation Schedule:</i>	
<i>Maintenance and Inspection:</i>	
<i>Responsible Staff:</i>	

[Repeat as needed](#)

SECTION 8: CERTIFICATION AND NOTIFICATION

□

Instructions:

- The SWPPP should be signed and certified by the construction operator(s). Attach a copy of the NOI and a copy of the General Storm Water Permit for Construction Activity. You can get a copy of the General Storm Water Permit for Construction Activity on the same web page that this template was obtained (www.waterquality.utah.gov/UPDES/stormwatercon.htm)

I certify under penalty of law that this document and all attachments were prepared under my direction or supervision in accordance with a system designed to assure that qualified personnel properly gathered and evaluated the information submitted. Based on my inquiry of the person or persons who manage the system, or those persons directly responsible for gathering the information, the information submitted is, to the best of my knowledge and belief, true, accurate, and complete. I am aware that there are significant penalties for submitting false information, including the possibility of fine and imprisonment for knowing violations.

Name: Jeremy Wilcock

Title: Vice President

Signature: 

Date: 10/31/2013

[Repeat as needed for multiple construction operators at the site](#)

SWPPP APPENDICES

Attach the following documentation to the SWPPP:

Appendix A – General Location Map

Appendix B – Site Maps

Appendix C – Construction General Permit

Appendix D – NOI and Acknowledgement Letter from EPA/State/MS4

Appendix E – Inspection Reports

Appendix F – Corrective Action Log (or in Part 5.3)

Appendix G – SWPPP Amendment Log (or in Part 6.2)

Appendix H – Subcontractor Certifications/Agreements

Appendix I – Grading and Stabilization Activities Log (or in Part 6.1)

Appendix J – Training Log

Appendix K – Delegation of Authority

Appendix L – Additional Information (i.e., Endangered Species and Historic Preservation Documentation; other permits such as dewatering, stream alteration, wetland; and out of date swppp documents)

Appendix M – BMP Specifications

Appendix A - General Location Map

PART OF THE SE.1/4 AND THE NE.1/4, OF SECTION 17, T.7N., R.1E., S.L.B. & M. SHEEP CREEK CLUSTER SUBDIVISION PHASE 4

TAXING UNIT: 36

IN WEBER COUNTY

SCALE 1" = 100'

SEE PAGE 7

SEE PAGES 243 & 244

SEE PAGE 7



SEE PAGE 124

SEE PAGE 7

S10°13'41"E
79.72'

Appendix B - Site Map

30' SETBACK

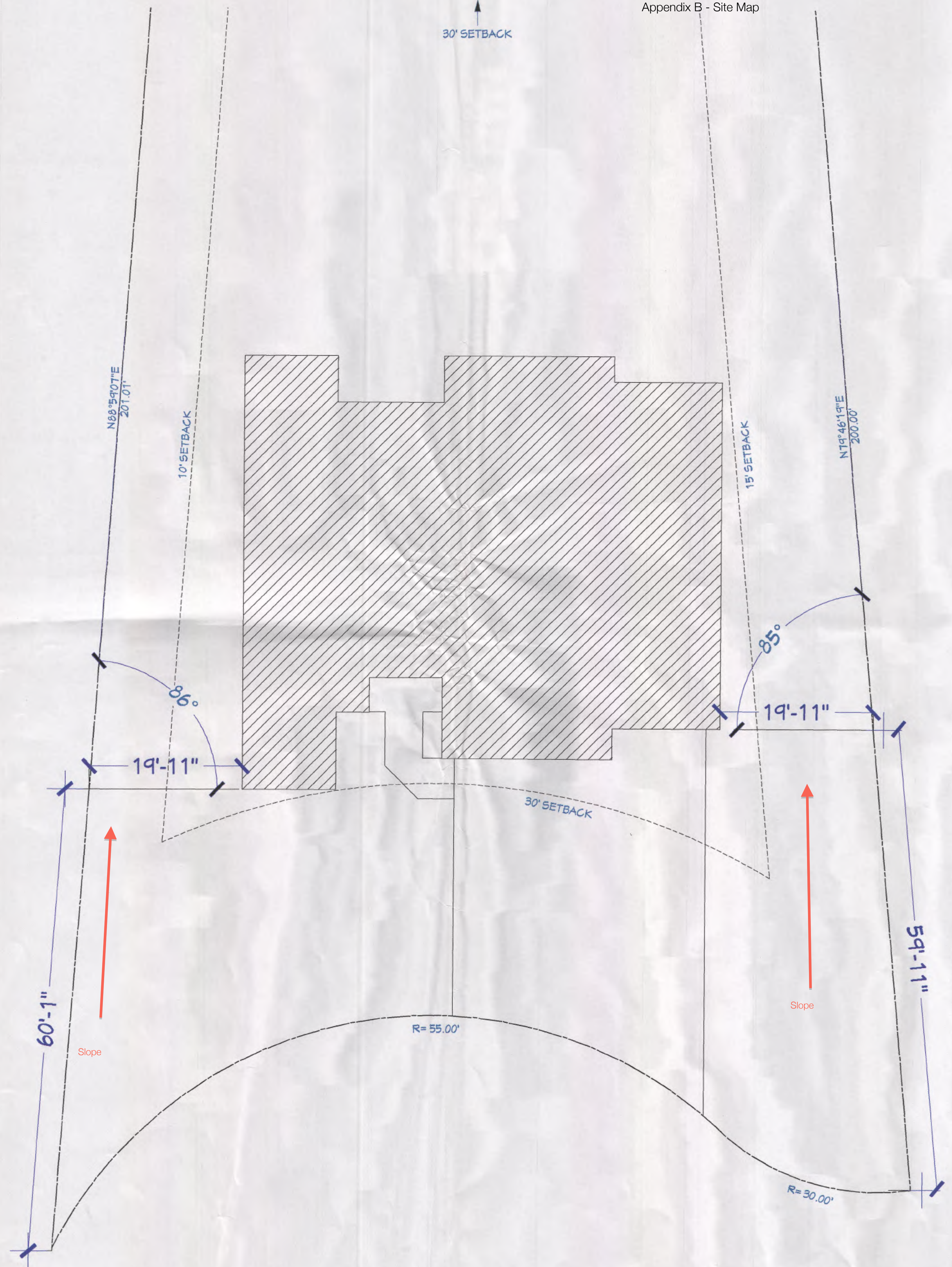

SITE PLAN
SCALE: 1/16"=1'-0"

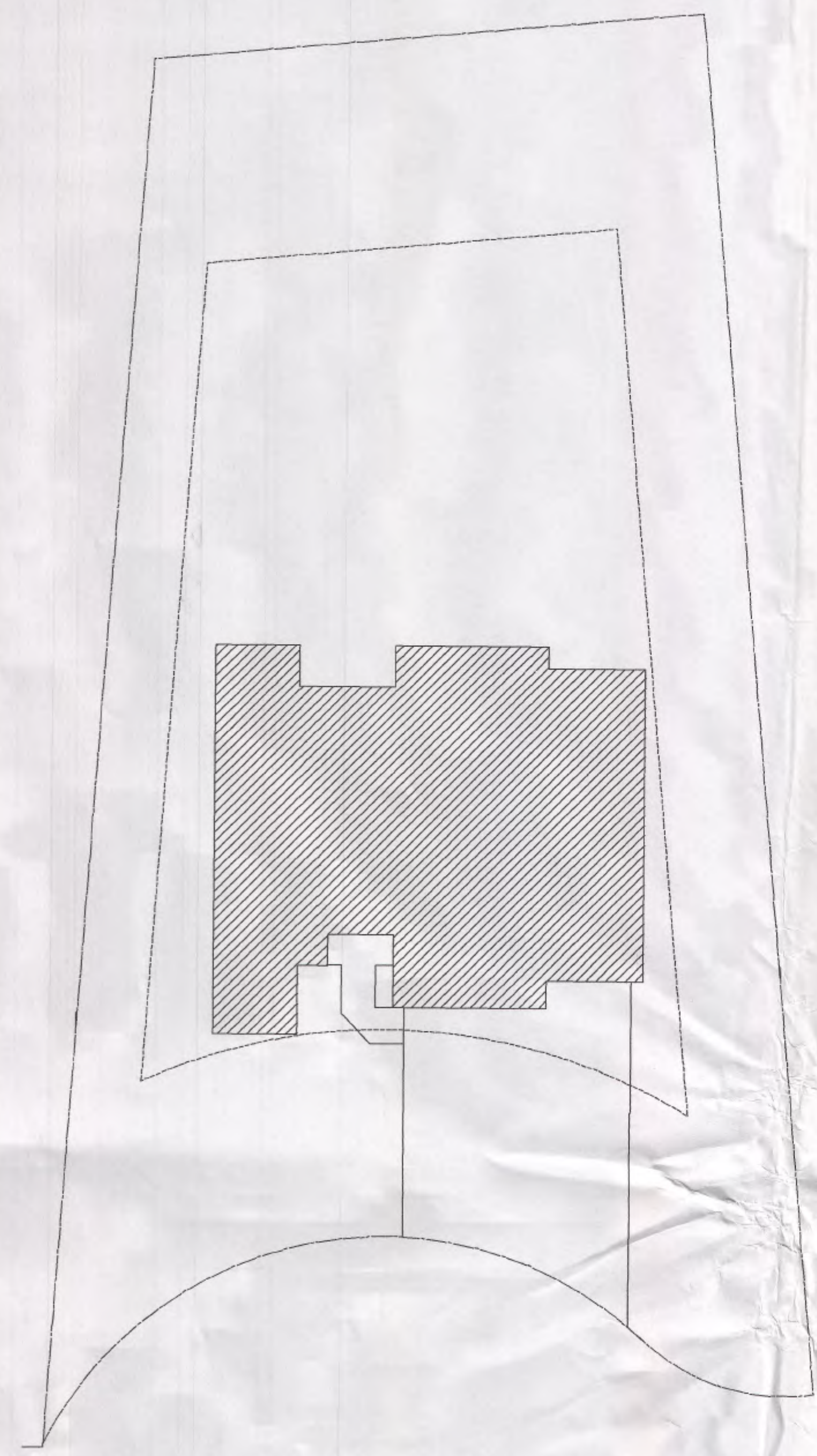

EDEN SITE LOT 119

SHEEP CREEK
CLUSTER SUDIVISION
4684 N. ABBEY WAY LOT 119
EDEN, UTAH

PLAN REVIEW ACCEPTANCE
FOR COMPLIANCE WITH THE APPLICABLE
CONSTRUCTION CODES DERIVED BELOW AND
AS AUTHORIZED BY THE JURISDICTION:

<input checked="" type="checkbox"/> BUILDING	<input checked="" type="checkbox"/> STRUCTURAL
<input type="checkbox"/> MECHANICAL	<input type="checkbox"/> PLUMBING
<input type="checkbox"/> ELECTRICAL	<input type="checkbox"/> FIRE
<input type="checkbox"/> ACCESSIBILITY	<input type="checkbox"/> SIGN

PLAN REVIEW ACCEPTANCE OF DOCUMENTS
DOES NOT AUTHORIZE CONSTRUCTION TO
PROCEED IN VIOLATION OF ANY FEDERAL, STATE,
OR LOCAL REGULATIONS.
BY: *[Signature]* DATE: 10/28/13
SEALS: BRUNN AND ASSOCIATES
SITE DESIGN AND LANDSCAPE ARCHITECTURE



CHRIS ANDERSON
DRAFTING & DESIGN
CADD L.C.

ATTENTION: THESE PLANS, DRAWINGS AND DESIGNS ARE THE PROPERTY OF CADD L.C. ALL RIGHTS ARE RESERVED. THESE DOCUMENTS SHALL NOT BE COPIED, REPRODUCED, OR USED WITHOUT THE WRITTEN CONSENT OF CADD L.C. THESE DOCUMENTS ARE RELEASED FOR ONE TIME USE FOR CONSTRUCTION.

PROJECT STATUS	10/24/2013
CONSTRUCTION SET	

SHEEP CREEK CLUSTER SUDIVISION
4684 N. ABBEY WAY LOT 119
EDEN, UTAH

LEVEL	SQ.FT.
MAIN	
UPPER	
LOWER	
GARAGE	
TOTAL	

OWNER CONTACT:

SHEET TITLE:
COVER SHEET

DATE: 10/24/2013
SCALE: AS NOTED

SHEET NUMBER:
A-1

SITE PLAN
SCALE: 1/8"=1'-0"



**STATE OF UTAH DEPARTMENT OF ENVIRONMENTAL QUALITY
DIVISION OF WATER QUALITY**

**Authorization to Discharge Under the
Utah Pollutant Discharge Elimination System**

**Storm Water General Permit for
Construction Activities
Permit No. UTR300000**

This Permit is issued in compliance with the provisions of the Utah Water Quality Act, Title 19, Chapter 5, Utah Code Annotated 2004, as amended (the "Act") and the federal Water Pollution Control Act (33 U.S.C. §§ 1251 *et. seq.*, as amended to date), and the rules and Regulations made pursuant to those statutes.

This Permit authorizes storm water discharges to waters of the State of Utah resulting from construction activities, including construction support activities, anywhere within the State of Utah as provided in Parts 1.4 and 1.5 of this Permit. This authorization is conditioned upon a discharger meeting the eligibility requirements in Part 1.2.2 of this Permit, including preparation of a Storm Water Pollution Prevention Plan prior to filing a Notice of Intent ("NOI") to discharge under this General Permit. A discharger is not covered by this Permit if the discharger submits an NOI but has not met these conditions.

This authorization is subject to the authority of the Utah Water Quality Board or the Executive Secretary of the Utah Water Quality Board to reopen this Permit (*see* Part 5.15 of this Permit), or to require a discharger to obtain an individual permit or use an alternative general permit (*see* Part 2.3 of this Permit). The issuance of a discharge permit authorization under this general Permit does not relieve Permittees of other duties and responsibilities under the Act or rules made under that Act. Significant terms used in this Permit are defined in Part 6 of this Permit.

This Permit shall become effective on July 1, 2008.

This Permit and the authorization to discharge shall expire at midnight, June 30, 2013, except as described in Part 2.4 of this Permit.

Signed this 26th day of June, 2008.

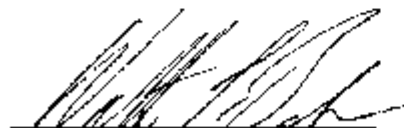

Walter L. Baker, P.E.
Executive Secretary,
Utah Water Quality Board

TABLE OF CONTENTS

PART 1: PERMIT SCOPE AND COVERAGE	3
1.1 Persons Required to Obtain Authorization for Discharge.....	3
1.2 Permit Area and Eligibility.....	3
1.3 Authorization to Discharge.....	3
1.4 Allowable Storm Water Discharges.....	3
1.5 Allowable Non-storm Water Discharges.....	4
1.6 Discharges Not allowed Under This Permit.....	4
1.7 Authorization to Discharge Date.....	5
1.8 Notice of Intent.....	5
1.9 Coverage Before October 1, 2008.....	5
1.10 Late Notifications.....	6
PART 2. SPECIAL CONDITIONS, MANAGEMENT PRACTICES, RESPONSIBILITIES, AND OTHER NON-NUMERIC LIMITATIONS	7
2.1 Releases in Excess of Reportable Quantities.....	7
2.2 Discharge Compliance with Water Quality Standards and TMDL Requirements.....	7
2.3 Requiring an Individual Permit or an Alternative General Permit.....	8
2.4 Continuation of the Expired General Permit.....	9
PART 3. STORM WATER POLLUTION PREVENTION PLANS	10
3.1 SWPPP Required.....	10
3.2 SWPPP Location, Availability, Revision, and Signature.....	10
3.3 Keeping SWPPPs Current.....	11
3.4 More Than One Permittee.....	11
3.5 Contents of SWPPP.....	12
PART 4. TERMINATION/CHANGES IN OWNER/OPERATOR FOR SITE	19
4.1 Termination of Coverage.....	19
4.2 Conditions for Submitting an NOT.....	19
4.3 Updating the SWPPP.....	
PART 5. STANDARD PERMIT CONDITIONS	20
5.1 Duty to Comply.....	20
5.2 Duty to Reapply.....	20
5.3 Need to Halt or Reduce Activity Not a Defense.....	20
5.4 Duty to Mitigate.....	20
5.5 Duty to Provide Information.....	20
5.6 Other Information.....	20
5.7 Oil and Hazardous Substance Liability.....	21
5.8 Property Rights.....	21
5.9 Severability.....	21
5.10 Record Retention.....	21
5.11 Addresses.....	21
5.12 State Laws.....	21
5.13 Proper Operation and Maintenance.....	21
5.14 Inspection and Entry.....	22
5.15 Reopener Clause.....	22
5.16 Signatory Requirements.....	22
PART 6. DEFINITIONS	24

PART 1: PERMIT SCOPE AND COVERAGE

- 1.1 Persons required to obtain authorization for discharge. No person may conduct construction activities that disturb an area greater than or equal to one acre without authorization for storm water discharge from the Executive Secretary. (See Utah Admin. Code Sections R317-8-3.9(6)(d)(10) and R317-8-3.9(6)(e)(1).) In addition, no person may conduct construction activities that disturb an area smaller than one acre if the disturbance is part of a larger common plan of development or sale that will ultimately disturb an area greater than or equal to one acre. *Id.* See Part 6.5 of this Permit for a definition of "construction activities."
- 1.2 Permit Area and Eligibility.
- 1.2.1. Construction activities located within the State of Utah, except for Indian Country (see Part 6.16 of this Permit for a definition of "Indian Country") may be eligible to be covered under this Permit.
- 1.2.2. Eligibility for authorization to discharge under this Permit is conditioned upon:
- Preparation of a Storm Water Pollution Prevention Plan ("SWPPP") (see Part 3 of this permit) prior to submission of a Notice of Intent ("NOI");
 - Submission of a complete and accurate Notice of Intent to be covered by this Permit (see Part 1.8 of this Permit); and
 - Payment of applicable fees.
- 1.3 Authorization to Discharge. This Permit authorizes discharges of storm water from construction activities that disturb an area greater than or equal to one acre, and from construction activities that disturb an area smaller than one acre if the disturbance is part of a larger common plan of development or sale that will ultimately disturb an area greater than or equal to one acre. This authorization is subject to all of the terms and conditions of this Permit, including the requirement that the discharger must submit a Notice of Intent ("NOI"), and the prohibitions on discharges specified in Part 1.6.
- 1.4 Allowable Storm Water Discharges. Subject to compliance with the terms and conditions of this Permit, a Permittee is authorized to discharge pollutants in:
- 1.4.1. Storm water associated with construction activity as that term is defined in Part 6.5 of this Permit (but see Part 1.4.3 of this Permit for limitations on discharges from construction support activities);
- 1.4.2. Storm water discharges designated by the Executive Secretary as needing a storm water permit under R317-8-3.9(6)(e)(2);
- 1.4.3. Discharges from construction support activities as that term is defined in Part 6.6 of this Permit, provided:
- The support activity is directly related to the construction site required to have UPDES permit coverage for discharges of storm water associated with construction activity;
 - The support activity is not a commercial operation serving multiple unrelated construction projects by different owners/operators, and does not operate beyond the completion of the construction activity at the last construction project it supports; and
 - Appropriate controls and measures are identified in a Storm Water Pollution

- Prevention Plan (SWPPP) covering the discharges from the support activity areas; and
- 1.4.4. Discharges composed of allowable discharges listed in Part 1.4 and 1.5 of this Permit commingled with a discharge authorized by a different UPDES permit and/or a discharge that does not require UPDES permit authorization.
- 1.5. Allowable Non-storm Water Discharges. A Permittee is authorized to make the following non-storm water discharges, provided the non-storm water component of the discharge is in compliance with Part 3.5.5 of this Permit:
- 1.5.1. Discharges from fire-fighting activities;
 - 1.5.2. Fire hydrant flushings;
 - 1.5.3. Waters used to wash vehicles where detergents are not used;
 - 1.5.4. Water used to control dust in accordance with Part 3.5.2(c)(2);
 - 1.5.5. Potable water including uncontaminated water line flushings;
 - 1.5.6. Routine external building wash down that does not use detergents;
 - 1.5.7. Pavement wash waters where spills or leaks of toxic or hazardous materials have not occurred (unless all spilled material has been removed) and where detergents are not used;
 - 1.5.8. Uncontaminated air conditioning or compressor condensate;
 - 1.5.9. Uncontaminated ground water or spring water;
 - 1.5.10. Foundation or footing drains where flows are not contaminated with process materials such as solvents;
 - 1.5.11. Landscape and other irrigation drainage.
- 1.6. Discharges not allowed under this Permit. Notwithstanding any other language in this Permit, the following storm water discharges are not authorized by this Permit:
- 1.6.1. Discharges from Construction Activities within Indian Country. This Permit does not cover discharges within Indian Country as that term is defined in Part 6.16 of this Permit;¹
 - 1.6.2. Post Construction Discharges. Storm water discharges that originate from the site after construction activities have been completed and the site has undergone final stabilization;
 - 1.6.3. Discharges Mixed with Non-storm Water. Discharges that are mixed with sources of non-storm water other than discharges which are identified in Part 1.5 of this Permit and in compliance with Part 3.5.5 (non-storm water discharges) of this Permit;
 - 1.6.4. Discharges Covered by Another Permit. Storm water discharges associated with construction activity for which an individual permit has been issued, or for which the owner/operator is required to or may obtain coverage under an individual permit or an alternative general permit (see Part 2.3 of this Permit), including a general

¹ The State of Utah, *Division of Water Quality*, does not have permit authority for Indian Country. Storm water permits for Indian Country within the State must be acquired through EPA Region VIII, except for facilities on the Navajo Reservation or on the Goshute Reservation which must acquire storm water permits through EPA Region IX.

permit issued for areas regulated by a qualified municipal Separate Storm Sewer System Program;

- 1.6.5. Discharges Threatening Water Quality. Storm water discharges from construction activities that cause or have the reasonable potential to cause a violation of a water quality standard. See Part 2.2 of this Permit;
 - 1.6.6. Discharges from commercial construction support and related activities. Storm water discharges from construction support activities unless they are included within the definition in Part 6.6 of this permit;
 - 1.6.7. Spills. This Permit does not authorize the discharge of hazardous substances or oil resulting from an on-site spill; and
 - 1.6.8. Discharges that result from violations of this Permit.
- 1.7 Authorization to Discharge Date.
- 1.7.1. This permit is effective as of July 1, 2008 and is effective for five years, expiring at 11:59 p.m. on June 30, 2013.
 - 1.7.2. Unless notified by the Executive Secretary to the contrary, a discharger is authorized for coverage under this Permit and may begin construction activities immediately after preparing a SWPPP for the construction activities (see Part 1.2.2(a) of this Permit), and after submitting an NOI and permit fee (see Part 1.2.2(b) and (c) of this Permit). The date of submission of the NOI or a permit fee shall be the date of its receipt by the Executive Secretary, or the date the NOI or permit fee are submitted electronically using the website for the Utah Division of Water Quality. Any NOIs mailed to the Executive Secretary shall be mailed to the address specified in Part 5.11 of this Permit.
 - 1.7.3. The Executive Secretary may, with written notice (including electronic notice) delay authorization to verify an applicant's eligibility or resolve other concerns. In these instances, a discharger is not authorized for coverage under this permit until it receives notice from the Executive Secretary.
- 1.8 Notice of Intent
- 1.8.1. A person who wishes to submit an NOI must use the NOI form provided by the Executive Secretary (or a copy thereof), or submit an NOI electronically (see (<https://secure.utah.gov/stormwater/>)).
 - 1.8.2. All questions in an NOI form provided by the Executive Secretary or answered in the course of submitting an NOI electronically must be answered completely and accurately.
 - 1.8.3. The NOI, whether on the form provided by the Executive Secretary or submitted electronically, must include a certification statement, and must be signed and dated by an authorized representative as specified in Part 5.16 of this Permit.
- 1.9 Coverage before June 30, 2010. Permittee's that previously received authorization to discharge under the October 1, 2002 General Permit (2002 General Permit) and still have active coverage shall without submission of an NOI continue coverage under UTR200000 until June 30, 2010 at which time, or before if desired, the Permittee shall, by submission of an NOI (either on-line www.waterquality.utah.gov/updes/stormwatercon.htm or by paper submission) obtain coverage under this Permit (UTR300000).

- 1.10 Late Notifications. Persons are not prohibited from submitting NOIs after initiating clearing, grading, excavation activities, or other construction activities. When a late NOI is submitted, authorization for discharges occurs consistent with Subpart 2.1. The Agency reserves the right to take enforcement action for any un-permitted discharges that occur between the commencement of construction and discharge authorization.

**PART 2. SPECIAL CONDITIONS, MANAGEMENT PRACTICES,
RESPONSIBILITIES, AND OTHER NON-NUMERIC LIMITATIONS**

- 2.1 Releases in excess of Reportable Quantities. The discharge of hazardous substances or oil in the storm water discharge(s) from a site shall be prevented or minimized in accordance with the applicable SWPPP for the site. This Permit does not relieve the Permittee of the reporting requirements of 40 CFR part 117, 40 CFR 110, and 40 CFR part 302. Where a release containing a hazardous substance in an amount equal to or in excess of a reportable quantity established under either 40 CFR 117, 40 CFR 110, or 40 CFR 302, occurs during a 24 hour period:
- 2.1.1. The Permittee is required to notify the National Response Center (NRC) (800-424-8802) in accordance with the requirements of 40 CFR 117, 40 CFR 110, and 40 CFR 302 and the Division of Water Quality (DWQ) (801-538-6146) or the 24 hour DWQ answering service at 801-536-4123 as soon as he or she has knowledge of the discharge;
 - 2.1.2. The Permittee shall submit within 14 calendar days of knowledge of the release a written description of: the release (including the type and estimate of the amount of material released), the date that such release occurred, the circumstances leading to the release, the measures taken and/or planned to be taken to cleanup the release, and steps to be taken to minimize the chance of future occurrences to the Executive Secretary; and
 - 2.1.3. The SWPPP required under Part 3 of this Permit must be modified within 14 calendar days of knowledge of the release to provide a description of the release, the circumstances leading to the release, and the date of the release. In addition, the SWPPP must be reviewed to identify measures to prevent the reoccurrence of such releases and to respond to such releases, and the SWPPP must be modified where appropriate.
- 2.2 Discharge Compliance with Water Quality Standards and TMDL requirements. Storm water discharges from construction activities that cause or have the reasonable potential to cause a violation of a water quality standard or a violation of Total Maximum Daily Load ("TMDL") requirements are not authorized by this Permit. If there is a TMDL requirement for the receiving water, that requirement, rather than a water quality standard, will govern. If a discharge that would otherwise be covered by this Permit causes a violation or if there is a reasonable potential a discharge will cause a violation, the Permittee will take all necessary actions to ensure future discharges do not cause or contribute to the violation of a water quality standard or a TMDL requirement, and shall document these actions in the SWPPP.

If the Executive Secretary determines that construction activities have caused or have the reasonable potential to cause a violation of a water quality standard or a TMDL requirement, the discharger will be notified by the Executive Secretary of additional requirements for treatment or handling of the discharge to ensure future discharges do not cause or contribute to the violation. The Permittee will document these requirements in the SWPPP. The Executive Secretary may authorize continued coverage under this Permit after appropriate controls and implementation procedures, designed to bring the discharges

into compliance with water quality standards or TMDL requirements, have been included in the SWPPP.

Alternatively, the Executive Secretary may notify the Permittee that an individual permit application is necessary (see Part 2.3 of this Permit).

If violations remain or re-occur, then coverage under this Permit may be terminated by the Executive Secretary and an alternative permit may be issued or denied. Compliance with this requirement does not preclude any enforcement activity as provided by the Water Quality Act for the underlying violation.

2.3 Requiring an Individual Permit or an Alternative General Permit.

- 2.3.1. The Executive Secretary may require any person authorized by this Permit to apply for and/or obtain either an individual UPDES permit or an alternative UPDES general permit. Any interested person may petition the Executive Secretary to take action under this paragraph. Where the Executive Secretary requires a discharger authorized to discharge under this Permit to apply for an individual UPDES permit, the Executive Secretary shall notify the discharger in writing that a permit application is required. This notification shall include a brief statement of the reasons for this decision, an application form or reference to the application requirements, a statement setting a deadline for the discharger to file the application, and a statement that on the effective date of issuance or denial of the individual UPDES permit or the alternative general permit as it applies to the individual Permittee, coverage under this general Permit shall automatically terminate. Applications shall be submitted to the address of the Division of Water Quality shown in Part 5.11 of this Permit. The Executive Secretary may grant additional time to submit the application upon request of the applicant. If a discharger fails to submit in a timely manner an individual UPDES permit application as required by the Executive Secretary under this paragraph, then the applicability of this Permit to the individual UPDES permittee is automatically terminated at the end of the day specified for application submittal.
- 2.3.2. Any discharger authorized by this Permit may request to be excluded from the coverage of this Permit by applying for an individual permit. In such cases, the discharger shall submit an individual application in accordance with the requirements of Utah Administrative Code ("UAC") R317-8-3.9(2)(b)2 with reasons supporting the request, to the Executive Secretary at the address for the Division of Water Quality in Part 5.11 of this Permit. The request may be granted by issuance of any individual permit or an alternative general permit if the reasons cited by the Permittee are adequate to support the request.
- 2.3.3. When an individual UPDES permit is issued to a discharger who would otherwise be subject to this Permit, or the discharger is authorized to discharge under an alternative UPDES general permit, the applicability of this Permit to the individual UPDES permittee is automatically terminated on the effective date of the individual permit or the date of authorization for coverage under the alternative general permit, whichever the case may be. When an individual UPDES permit is denied to a discharger otherwise subject to this Permit or the discharger is denied for coverage under an alternative UPDES general permit, the applicability of this Permit to the

individual UPDES permittee is automatically terminated on the date of such denial, unless otherwise specified by the Executive Secretary.

- 2.4 Continuation of the Expired General Permit. This Permit expires on June 30, 2013. However, an expired general permit shall continue in force and effect after the expiration date until a new general permit is issued. If a discharger was eligible for and permitted under this Permit, and this Permit expires, the discharger will remain covered by this Permit until the earliest of:
- 2.4.1. One hundred twenty days after re-issuance or replacement of this Permit;
 - 2.4.2. The discharger submits a Notice of Termination in compliance with this Permit;
 - 2.4.3. The discharger is issued an individual permit for the project's discharges; or
 - 2.4.4. 180 days after the Executive Secretary makes a formal decision not to reissue or replace this Permit, at which time the discharger must seek coverage under an alternative general permit or an individual permit.

PART 3. STORM WATER POLLUTION PREVENTION PLANS

- 3.1. SWPPP required. A Storm Water Pollution Prevention Plan ("SWPPP") shall be developed for each construction project covered by this Permit prior to submission of an NOI. A SWPPP shall be prepared in accordance with good engineering practices. It is recommended that the plan be signed by a Professional Engineer (P.E.) registered in the State. The SWPPP shall identify potential sources of pollution which may reasonably be expected to affect the quality of storm water discharges from the construction site, shall describe and ensure the implementation of practices which will be used to reduce the pollutants in storm water discharges associated with construction activity at the construction site and to assure compliance with the terms and conditions of this Permit, and shall otherwise meet the requirements of this Permit. As a condition of this Permit, Permittees must implement the SWPPP as written or modified from commencement of construction until final stabilization is complete and an NOI has been submitted. (This provision is not intended to address the potential liability of a Permittee or other current or former operator or owner in the event of a discharge of pollution from the property of an individual homeowner.)
- 3.2. SWPPP Location, Availability, Revision, and Signature.
- 3.2.1. SWPPP Location. A copy of the SWPPP, including a copy of the Permit, the NOI, and any amendments to the SWPPP, shall be retained on-site at the site which generates the storm water discharge in accordance with this Part 3.2 and with Part 5.10 of this Permit. If the site is inactive or does not have an onsite location adequate to store the copy of the SWPPP, reasonable local access to a copy of the SWPPP during normal working hours (e.g., at a local library or government building), must be provided and the location of the SWPPP, along with a contact phone number, shall be posted on site at a publicly-accessible location. For linear construction projects, such as pipelines, the posted notice shall be located at a publicly accessible location near the active part of the construction project.
- 3.2.2. SWPPP Availability. The Permittee shall make the copy of the SWPPP that is kept on-site or kept locally available for review upon request to the Executive Secretary; EPA; other local agencies approving sediment and erosion plans, grading plans, or storm water management plans; local government officials; or to the operators of a municipal separate storm sewer receiving discharges from the site. The Permittee need not provide a free copy of the SWPPP to these entities upon request, but if it chooses not to do so, it shall keep two copies of the SWPPP, in its entirety, and shall allow these entities to borrow one to make a copy at their own expense.
- 3.2.3. Original SWPPP. If requested by the Executive Secretary, the original SWPPP, including any previous versions requested, shall be provided to the Executive Secretary within five working days of the request. The original provided shall be signed in accordance with Part 5.16 of this Permit.
- 3.2.4. SWPPP Availability to the Public. The Permittee shall also make a copy of the SWPPP available to the public to review at reasonable times during regular business hours. Advance notice by the public of the desire to view the SWPPP may be required, not to exceed two working days. The Permittee need not provide a free copy of the SWPPP to members of the public, but if it chooses not to do so, it shall

- keep two copies of the SWPPP, in its entirety, and shall allow members of the public to borrow one to make a copy at their own expense.
- 3.2.5. Compelled Revisions. The Executive Secretary, or an authorized representative of the Executive Secretary, may notify the Permittee (co-Permittees) at any time that the SWPPP does not meet one or more of the minimum requirements of this Part 3. Such notification shall identify those provisions of the Permit which are not being met by the SWPPP, and identify which provisions of the SWPPP require modifications in order to meet the minimum requirements of this Part 3. Within 7 days of such notification from the Executive Secretary, (or as otherwise provided by the Executive Secretary), or authorized representative, the Permittee shall make the required changes to the SWPPP and shall submit to the Executive Secretary a written certification that the changes have been made. The Executive Secretary may take appropriate enforcement action for the period of time the Permittee was operating under a SWPPP that did not meet the minimum requirements of the Permit.
- 3.2.6. All SWPPPs must be signed and certified in accordance with Part 5.16 of this Permit.
- 3.3. Keeping SWPPPs Current.
- 3.3.1. The Permittee shall amend the SWPPP whenever there is a change in design, construction, operation, or maintenance, which has a significant effect on the discharge of pollutants to the waters of the State and which has not otherwise been addressed in the SWPPP.
- 3.3.2. The Permittee shall amend the SWPPP whenever inspections or investigations by site operators, local, state, or federal officials indicate the SWPPP is proving ineffective in eliminating or significantly minimizing pollutants from sources identified under Part 3.5.1 of this Permit, or is otherwise not achieving the general objectives of controlling pollutants in storm water discharges associated with construction activity.
- 3.3.3. The Permittee shall amend the SWPPP whenever a new owner/operator becomes responsible for implementing all or part of the SWPPP, as further described in Part 3.4 and Part 4.3 of this Permit.
- 3.3.4. The following records of activities shall be maintained as part of the SWPPP:
- Dates when major grading activities occur;
 - Dates when construction activities temporarily or permanently cease on a portion of or all of the site; and
 - Dates when stabilization measures are initiated.
- 3.3.5. Once an area has been finally stabilized, the Permittee may identify this area in the SWPPP and no further SWPPP or inspection requirements shall apply to that area.
- 3.4. More than one Permittee. A SWPPP may identify more than one Permittee and may specify the responsibilities of each Permittee by task, area, and/or timing. Permittees may coordinate and prepare more than one SWPPP to accomplish this. However, in the event there is a requirement under the SWPPP for which responsibility is ambiguous or is not included in the SWPPP(s), each Permittee shall be responsible for implementation of that requirement. Each Permittee is also responsible for assuring that its activities do not render another Permittee's controls ineffective.

- 3.5. Contents of SWPPP. The SWPPP shall include the following items:
- 3.5.1. Site Description. Each SWPPP shall provide a description of pollutant sources and other information as indicated:
- a. A description of the nature of the construction activity;
 - b. A description of the intended sequence of major activities which disturb soils for major portions of the site (e.g. grubbing, excavation, grading, utilities, and infrastructure installation);
 - c. Estimates of the total area of the site and the total area of the site that is expected to be disturbed by excavation, grading, or other activities, including areas for construction support;
 - d. An estimate of the runoff coefficient of the site after construction activities are completed and existing data describing the soil or the quality of any discharge from the site;
 - e. A general location map (e.g. portion of a city or county map or similar scale) and a site map indicating:
 - 1) drainage patterns and approximate slopes anticipated after major grading activities;
 - 2) construction boundaries and a description of existing vegetation prior to grading activities;
 - 3) areas of soil disturbance, and areas of no disturbance;
 - 4) the location of major structures and nonstructural controls identified in the SWPPP;
 - 5) Locations of areas used for construction support;
 - 6) the location of areas where stabilization practices are expected to occur;
 - 7) the location of surface waters (including wetlands); and
 - 8) locations where storm water is discharged or will discharge to a surface water;
 - f. A description of any discharge associated with industrial activity other than construction at the site (including storm water discharges from dedicated portable asphalt plants and dedicated portable concrete plants), whether or not those discharges are covered by the Permit; and the location of that activity;
 - g. The name of the receiving water(s), and aerial extent of wetland acreage at the site; and
 - h. A copy of this Permit.
- 3.5.2. Controls. The SWPPP shall employ best management practices to control pollutants in storm water discharges. Each plan shall include a description of appropriate controls and measures that will be implemented during construction activity and while the site is unstabilized. The plan must clearly describe for each major activity identified in Part 3.5.1(b) appropriate control measures and the timing during the construction process that the measures will be implemented. The description and implementation of controls shall address the following minimum components:
- a. Erosion and Sediment Controls.
 - 1) Short and Long Term Goals and Criteria:
 - A) The construction-phase erosion and sediment controls should be designed to retain sediment on site to the maximum extent

- practicable.
- B) All control measures must be properly selected, installed, and maintained in accordance with the manufacturer's specifications and good engineering practices. If periodic inspections or other information indicates a control has been used inappropriately, incorrectly, or is ineffective the Permittee must replace or modify the control for site situations.
 - C) If sediments escape the construction site, off-site accumulations of sediment must be removed at a frequency sufficient to minimize the possibility of offsite impacts such as fugitive sediments washing into storm sewers by the next rain or posing a safety hazard to users of public streets.
 - D) Sediment must be removed from sediment traps or sedimentation ponds when design capacity has been reduced by 50%.
 - E) Litter, construction debris, and construction chemicals exposed to storm water shall be picked up prior to anticipated storm events (e.g. forecasted by local weather reports), or otherwise prevented from becoming a pollutant source for storm water discharges (e.g. screening outfalls, picked up daily, etc.).
 - F) Offsite material storage areas (also including overburden and stockpiles of dirt, etc.) used solely by the Permitted project are considered a part of the project and, unless a Permittee submits a separate NOI for such areas or they are subject to a separate UPDES permit, they shall be addressed in the SWPPP.
- 2) **Stabilization Practices.** A description of existing interim and permanent stabilization practices, including site-specific scheduling of the implementation of the practices. SWPPPs should ensure that existing vegetation is preserved where attainable and that disturbed portions of the site are stabilized. Stabilization practices may include: temporary seeding, permanent seeding, mulching, geo-textiles, sod stabilization, vegetative buffer strips, protection of trees, preservation of mature vegetation, and other appropriate measures. Use of impervious surfaces for stabilization should be avoided. Except as provided in paragraphs (A) and (B) below (Parts 3.5.2(a)(2)(A) and (B)), stabilization measures shall be initiated as soon as practicable in portions of the site where construction activities have temporarily or permanently ceased, but in no case more than 14 days after the construction activity in that portion of the site has temporarily or permanently ceased.
- A) Where the initiation of stabilization measures by the 14th day after construction activity temporarily or permanently ceases is precluded by snow cover or frozen ground conditions, stabilization measures shall be initiated as soon as practicable.
 - B) Where construction activity on a portion of the site is temporarily ceased, and earth disturbing activities will be resumed within 21 days, temporary stabilization measures do not have to be initiated on that portion of the site.
- 3) **Structural Practices.** The permittee shall provide a description of

structural practices that divert flows from exposed soils, store flows or otherwise limit runoff and the discharge of pollutants from exposed areas of the site to the degree attainable. Such practices may include silt fences, earth dikes, drainage swales, sediment traps, check dams, subsurface drains, pipe slope drains, level spreaders, storm drain inlet protection, rock outlet protection, reinforced soil retaining systems, gabions, and temporary or permanent sediment basins. Placement of structural practices in floodplains should be avoided to the degree attainable. The installation of these devices may be subject to Section 404 of the federal Clean Water Act ("CWA").

- A) 10 Acre Sediment Basin Requirement. Where attainable, for common drainage locations that serve areas with 10 or more acres disturbed at one time, the Permittee shall provide a temporary (or permanent) sediment basin that provides storage for a 10 year, 24 hour storm event, a calculated volume of runoff for disturbed acres drained, or equivalent control measures, until final stabilization of the site. Where calculations are not performed, a sediment basin providing 3,600 cubic feet of storage per acre drained (a 1 inch storm event), or equivalent control measures, shall be provided where attainable until final stabilization of the site. The required sizing of the sediment basin does not include flows from offsite areas and flows from onsite areas that are either undisturbed or have undergone final stabilization where such flows are diverted around both the disturbed area and the sediment basin. In determining whether installing a sediment basin is attainable, factors such as site soils, slope, and available area on site shall be considered. For drainage locations which serve 10 or more disturbed acres at one time and where a temporary sediment basin or equivalent controls is not attainable, smaller sediment basins and/or sediment traps (with comparable storage) must be used; or
- (i) at a minimum, equivalent controls in silt fences, vegetative buffer strips, sod, mulch, geo-textiles, stepped check dams, pipe slope drains or other sediment or erosion controls are required for all erodible areas, down slope boundaries of the construction area and side slope boundaries deemed appropriate as dictated by individual site conditions; or
 - (ii) it can be shown that site meteorological conditions do not warrant equivalent storage during the time period the 10-acres are destabilized (little or no chance of precipitation for the period of surface destabilization).
- B) Less Than 10 Acre BMP Requirement. For drainage locations serving less than 10 acres, sediment basins and/or sediment traps should be used. At a minimum, silt fences, vegetative buffer strips, or equivalent sediment controls are required for all down slope boundaries (and those side slope boundaries deemed appropriate as dictated by individual site conditions) of the construction area unless a sediment basin providing storage for

3,600 cubic feet of storage per acre drained is provided.

- b. Storm Water Management. Description of measures that will be installed during the construction process to control pollutants in storm water discharges that will occur after construction operations have been completed. Structural measures should be placed on upland soils to the degree attainable. The installation of these devices may be subject to Section 404 of the CWA. This Permit only addresses the installation of storm water management measures, and not the ultimate operation and maintenance of such structures after the construction activities have been completed and the site has undergone final stabilization. Permittees are only responsible for the installation and maintenance of storm water management measures prior to final stabilization of the site, and are not responsible for maintenance after storm water discharges associated with construction activity have been eliminated from the site. However, post-construction storm water BMPs that discharge pollutants from point sources once construction is completed, may in themselves, need authorization under a separate UPDES permit and are likely regulated under local municipal requirements.
- 1) Such measures may include:
 - A) storm water detention structures (including wet ponds);
 - B) storm water retention structures;
 - C) flow-attenuation by use of open vegetated swales and natural depressions;
 - D) infiltration of runoff onsite; and
 - E) sequential systems (which combine several practices).
 - 2) The SWPPP shall include an explanation of the technical basis used to select the practices to control pollution where flows exceed predevelopment levels.
 - 3) Storm water velocity dissipation devices shall be placed at discharge locations and along the length of any outfall channel for the purpose of providing a non-erosive flow velocity from the structure to a water course so that the natural physical and biological characteristics and functions are maintained and protected. The objective is to minimize significant changes in the hydrological regime of the receiving water.
- c. Other Controls.
- 1) Waste Disposal. No solid materials, including building materials, shall be discharged to waters of the State, except as authorized by a federal CWA Section 404 permits.
 - 2) Off-site Tracking. Off-site vehicle tracking of sediments and the generation of dust shall be minimized.
 - 3) Septic, Waste, and Sanitary Sewer Disposal. The SWPPP shall ensure and demonstrate compliance with applicable State and/or local waste disposal, sanitary sewer or septic system regulations.
 - 4) Exposure to Construction Materials. The SWPPP shall include a narrative description of practices to reduce pollutants from construction related materials which are stored onsite including an inventory of construction materials (including waste materials), storage practices to minimize exposure of the materials to storm water, and spill prevention and

response.

- 5) Support Areas. A description of pollutant sources from areas other than construction (including storm water discharges from dedicated portable asphalt plants and dedicated portable concrete plants), and a description of controls and measures that will be implemented at those sites.

d. Other Laws and Requirements.

- 1) Local Storm Water Control Requirements. This Permit does not relieve the Permittee from compliance with other laws effecting erosion and sediment control or requirements for the permanent storm water system. Where applicable, compliance efforts to these requirements should be reflected in the SWPPP.
- 2) Threatened or Endangered Species & Historic Properties. This Permit does not relieve the Permittee from compliance with Federal or State laws pertaining to threatened or endangered species or historic properties. Where applicable compliance efforts to these laws should be reflected in the SWPPP.
- 3) Variance of Permit Requirements. Dischargers seeking alternative permit requirements shall submit an individual UPDES permit application in accordance with applicable law to the address indicated in Part 5.11 of this Permit, along with a description of why requirements in this Permit should not be applicable as a condition of a UPDES permit.

3.5.3. Maintenance. All vegetation, erosion and sediment control measures and other protective measures identified in the SWPPP shall be maintained in effective operating condition. A description of procedures to ensure the timely maintenance of these measures shall be identified in the SWPPP. Maintenance needs identified in inspections or by other means shall be accomplished before the next anticipated storm event, or as necessary to maintain the continued effectiveness of storm water controls. If maintenance prior to the next anticipated storm event is impracticable, maintenance must be scheduled and accomplished as soon as practicable.

3.5.4. Inspections.

- a. Inspections must be conducted in accordance with one of the two schedules listed below. The Permittee shall specify in its SWPPP which schedule it will be following.
 - 1) At least once every 7 calendar days; or
 - 2) At least once every 14 calendar days and within 24 hours of the end of a storm event of 0.5 inches or greater.
- b. Inspection frequency may be reduced to at least once every month if:
 - 1) The entire site is temporarily stabilized; or
 - 2) Runoff is unlikely due to winter conditions (e.g., site is covered with snow, ice, or the ground is frozen).
- c. The inspection requirement is waived until one month before thawing conditions are expected to result in a discharge if all of the following requirements are met:
 - 1) The project is located in an area where frozen conditions are anticipated to continue for extended periods of time (i.e., more than one month);

- 2) Land disturbance activities have been suspended; and
 - 3) The beginning and ending dates of the waiver period are documented in the SWPPP.
- d. Inspections must be conducted by qualified personnel (provided by the operator or cooperatively by multiple operators). "Qualified personnel" means a person knowledgeable in the principles and practice of erosion and sediment controls who possesses the skills to assess conditions at the construction site that could impact storm water quality and to assess the effectiveness of any sediment and erosion control measures selected to control the quality of storm water discharges from the construction activity.
- e. Inspections must include all areas of the site disturbed by construction activity and areas used for storage of materials that are exposed to precipitation. Inspectors must look for evidence of, or the potential for, pollutants entering the storm water conveyance system. Sedimentation and erosion control measures identified in the SWPPP must be observed to ensure proper operation. Discharge locations must be inspected to ascertain whether erosion control measures are effective in preventing significant impacts to waters of the United States, where accessible. Where discharge locations are inaccessible, nearby downstream locations must be inspected to the extent that such inspections are practicable. Locations where vehicles enter or exit the site must be inspected for evidence of off-site sediment tracking.
- f. Inspections at construction sites involving utility line installation, pipeline construction, and other long, narrow, linear construction may be more limited if the areas described in Part 3.5.4(e) of this Permit are not reasonably accessible or could cause additional disturbance of soils and increase the potential for erosion. In these circumstances, controls must be inspected at the same frequency as other construction projects, but personnel may instead inspect controls along the construction site for 0.25 mile above and below each access point where a roadway, undisturbed right-of-way, or other similar feature intersects the construction site and allows access to the areas described above. In the absence of evidence to the contrary, the conditions of the controls along each inspected 0.25 mile segment may be considered as representative of the condition of controls along that reach extending from the end of the 0.25 mile segment to either the end of the next 0.25 mile inspected segment, or to the end of the project, whichever occurs first.
- g. For each inspection required above, the inspector must complete an inspection report. At a minimum, the inspection report must include:
- 1) The inspection date;
 - 2) Names, titles, and qualifications of personnel making the inspection;
 - 3) Weather information for the period since the last inspection (or since commencement of construction activity if the first inspection) including a best estimate of the beginning of each storm event, duration of each storm event, approximate amount of rainfall for each storm event (in inches), and whether any discharges occurred;
 - 4) Weather information and a description of any discharges occurring at the time of the inspection;
 - 5) Location(s) of discharges of sediment or other pollutants from the site;

- 6) Location(s) of BMPs that need to be maintained;
 - 7) Location(s) of BMPs that failed to operate as designed or proved inadequate for a particular location;
 - 8) Location(s) where additional BMPs are needed that did not exist at the time of inspection; and
 - 9) Corrective action required including any changes to the SWPPP necessary and implementation dates.
- h. A record of each inspection and of any actions taken in accordance with this Part 3 must be retained as part of the SWPPP for at least three years from the date that permit coverage expires or is terminated. The inspection reports must identify any incidents of non-compliance with the permit conditions. Where a report does not identify any incidents of non-compliance, the report must contain a certification that the construction project or site is in compliance with the SWPPP and this permit. The report must be signed in accordance with Part 5.16 of this Permit.

- 3.5.5. Non-Storm Water Discharges. Except for flows from fire fighting activities, sources of non-storm water listed in Part 1.5 of this Permit that are combined with storm water discharges associated with industrial activity must be identified in the SWPPP. The SWPPP shall identify and ensure the implementation of appropriate pollution prevention measures for the non-storm water component(s) of the discharge.

PART 4 . TERMINATION/CHANGES IN OWNER/OPERATOR FOR SITE

- 4.1. Termination of Coverage: Permittees may or shall (as specified) terminate coverage under this Permit under the following conditions:
- 4.1.1. Completion of construction activities and site stabilization: Permittees shall terminate coverage under this Permit by submitting a Notice of Termination ("NOT") within thirty days after completion of all construction activities, completion of final stabilization of all areas of the site as defined in Part 6.15. The NOT shall be submitted on the form specified by the Executive Secretary.
- 4.1.2. Partial completion of construction activities and site stabilization: A Permittee who, as specified in Part 3.4 of this Permit, is identified in the SWPPP as responsible for a specific area may terminate coverage under this Permit by submitting an NOI within thirty days after completion, for that area, of all construction activities, completion of final stabilization of all areas for which the Permittee was responsible and that were disturbed. The NOI shall be submitted on the form specified by the Executive Secretary, and the Permittee shall indicate on the form that it is a partial NOI.
- 4.1.3. New responsible owner/operator: A Permittee may terminate its coverage under this Permit by submitting an NOI if another party (or parties) assumes responsibility for all remaining SWPPP requirements. Termination of the Permittee's responsibilities under the SWPPP will not be final until the other party (or parties) submits an NOI. If the new responsible owner/operator fails to submit an NOI, the Permittee may complete termination by demonstrating to the Executive Secretary that it has entered into contracts that obligate the new owner/operator to undertake all remaining responsibilities under the SWPPP.
- 4.2. Conditions for Submitting an NOT: A Permittee may not submit an NOT unless it meets the requirements specified in Part 4.1. Appropriate enforcement actions may be taken if an NOT is submitted without these requirements having been met, and the Permittee may also continue to be responsible for any Permit violations.
- 4.3. Updating the SWPPP: If an NOI is submitted under Part 4.1.2 or 4.1.3, the SWPPP shall be updated by the remaining Permittee(s) to meet the requirements of Part 3.4 of the Permit.

PART 5. STANDARD PERMIT CONDITIONS

5.1. Duty to Comply.

5.1.1. The Permittee must comply with all conditions of this Permit. Any Permit noncompliance constitutes a violation of the Act and is grounds for enforcement action; for Permit termination, revocation and reissuance, or modification; or for denial of a permit renewal application.

5.1.2. Penalties for Violations of Permit Conditions.

a. Violations. The Act provides that any person who violates the Act, Utah wastewater rules, or conditions of a permit issued under the Act is subject to a fine of \$10,000 per day.

b. Willful or Gross Negligence. The Act provides that any person who discharges a pollutant to waters of the State as a result of criminal negligence or who intentionally discharges is criminally liable and is subject to imprisonment and a fine of up to \$50,000 per day. Utah Code Ann. § 19-5-115.

c. False Statements. The Act provides that any person who knowingly makes any false material statement, representation, or certification in any application, record, report, plan, or other document filed or required to be maintained under the Act, the rules, or this Permit, or who knowingly falsifies, tampers with, or renders inaccurate, any monitoring device or method required to be maintained under the Act shall upon conviction, be punished by a fine of not more than \$10,000 or by imprisonment for 6 months, or by both. Utah Code Ann. § 19-5-115(4).

5.2. Duty to Reapply. If a Permittee wishes to continue an activity regulated by this permit after the expiration date of this permit, it must apply for and obtain a new permit except as provided in Part 2.4 of this Permit.

5.3. Need to halt or reduce activity not a defense. It shall not be a defense for a Permittee in an enforcement action that it would have been necessary to halt or reduce the permitted activity in order to maintain compliance with the conditions of this Permit.

5.4. Duty to Mitigate. The Permittee shall take all reasonable steps to minimize or prevent any discharge in violation of this Permit which has a reasonable likelihood of adversely affecting human health or the environment.

5.5. Duty to Provide Information. The Permittee shall furnish to the Executive Secretary or an authorized representative, within a reasonable time, any information which is requested to determine compliance with this Permit. The Permittee must also furnish to the Executive Secretary or an authorized representative copies of records to be kept by this Permit.

5.6. Other Information. When the Permittee becomes aware that he or she failed to submit any relevant facts or submitted incorrect information in the Notice of Intent or in any other report to the Executive Secretary, he or she shall promptly submit such facts or information.

- 5.7. Oil and Hazardous Substance Liability. Nothing in this Permit shall be construed to preclude the institution of any legal action or relieve the Permittee from any responsibilities, liabilities, or penalties to which the Permittee is or may be subject under the "Act".
- 5.8. Property Rights. The issuance of this Permit does not convey any property rights of any sort, nor any exclusive privileges, nor does it authorize any injury to private property nor any invasion of personal rights, nor any infringement of Federal, State or local laws or regulations.
- 5.9. Severability. The provisions of this Permit are severable, and if any provision of this Permit, or the application of any provision of this Permit to any circumstance, is held invalid, the application of such provision to other circumstances, and the remainder of this Permit shall not be affected thereby.
- 5.10. Record Retention.
- 5.10.1. The Permittee shall retain copies of SWPPPs and all reports required by this Permit, and records of all data used to complete the Notice of Intent to be covered by this Permit, for a period of at least three years from the date that the site is finally stabilized. This period may be extended by request of the Executive Secretary at any time.
- 5.10.2. After final stabilization of the construction site is complete, the SWPPP is no longer required to be maintained on site, but may be maintained by the Permittee(s) at its primary headquarters. Access to the SWPPP will continue as described in Part 3.2, however.
- 5.11. Addresses. All written correspondence under this permit shall be directed to the Division of Water Quality at the following address:
- Department of Environmental Quality
Division of Water Quality
288 North 1460 West
PO Box 144870
Salt Lake City, Utah 84114-4870
- 5.12. State Laws.
- 5.12.1. Nothing in this Permit shall be construed to preclude the institution of any legal action or relieve the Permittee from any responsibilities, liabilities, or penalties established pursuant to any applicable State law or regulation under authority preserved by Utah Code Ann. § 19-5-117.
- 5.12.2. No condition of this Permit shall release the Permittee from any responsibility or requirements under other environmental statutes or regulations.
- 5.13. Proper Operation and Maintenance. The Permittee shall at all times properly operate and maintain all facilities and systems of treatment and control (and related appurtenances) which are installed or used by the Permittee to achieve compliance with the conditions

of this Permit and with the requirements of SWPPPs. Proper operation and maintenance also includes adequate laboratory controls and appropriate quality assurance procedures. Proper operation and maintenance requires the operation of backup or auxiliary facilities or similar systems, installed by a Permittee only when necessary to achieve compliance with the conditions of the Permit.

5.14. Inspection and Entry. The Permittee shall allow, upon presentation of credentials, the Executive Secretary or an authorized representative:

- 5.14.1. To enter upon the Permittee's premises where a regulated facility or activity is located or conducted or where records must be kept under the conditions of this Permit;
- 5.14.2. Have access to and copy at reasonable times, any records that must be kept under the conditions of this Permit;
- 5.14.3. Inspect at reasonable times any facilities, equipment (including monitoring and control equipment), practices, or operations regulated or required under this Permit; and
- 5.14.4. Sample or monitor at reasonable times, for the purposes of assuring permit compliance or as otherwise authorized by law, any substances or parameters at any location.

5.15. Reopener Clause.

- 5.15.1. Reopener Due to Water Quality Impacts. If there is evidence indicating that the storm water discharges authorized by this Permit cause, have the reasonable potential to cause or contribute to, a violation of a water quality standard, the discharger may be required to obtain an individual permit or an alternative general permit in accordance with Part 2.3 of this Permit or the Permit may be modified to include different limitations and/or requirements.
- 5.15.2. Reopener Guidelines. Permit modification or revocation will be conducted according to UAC R317-8-5.6 and UAC R317-8-6.2.
- 5.15.3. Permit Actions. This Permit may be modified, revoked and reissued, or terminated for cause. The filing of a request by the Permittee for a Permit modification, revocation and reissuance, or termination, or a notification of planned changes or anticipated noncompliance does not stay any Permit condition.

5.16. Signatory Requirements.

- 5.16.1. All Notices of Intent, SWPPPs, reports, certifications or information submitted to the Executive Secretary, or that this Permit requires be maintained by the Permittee, shall be signed as follows:
 - a. All Notices of Intent shall be signed as follows:
 - 1) For a corporation: by a responsible corporate officer. For the purpose of this section, a responsible corporate officer means: a president, secretary, treasurer, or vice-president of the corporation in charge of a principal business function, or any other person who performs similar policy or decision-making functions for the corporation; or the manager of one or more manufacturing, production or operating facilities employing more than 250 persons or having gross annual sales or expenditures exceeding \$25,000,000 (in second-quarter 1980 dollars) if authority to sign

- documents has been assigned or delegated to the manager in accordance with corporate procedures;
- 2) For a partnership or sole proprietorship: by a general partner or the proprietor, respectively; or
 - 3) For a municipality, State, Federal, or other public agency: by either a principal executive officer or ranking elected official. For purposes of this section, a principal executive officer of a Federal agency includes (1) the chief executive officer of the agency, or (2) a senior executive officer having responsibility for the overall operations of a principal geographic unit of the agency (e.g. Regional Administrators of EPA).
- b. All reports required by the Permit and other information requested by the Executive Secretary or by an authorized representative of the Executive Secretary shall be signed by a person described above or by a duly authorized representative of that person. A person is a duly authorized representative only if:
- 1) The authorization is made in writing by a person described above and submitted to the Executive Secretary; and
 - 2) The authorization specifies either an individual or a position having responsibility for overall operation of the regulated site, facility or activity, such as the position of manager, operator, superintendent, or position of equivalent responsibility or an individual or position having overall responsibility for environmental matters for the company. (A duly authorized representative may thus be either a named individual or any individual occupying a named position).
- c. Certification. Any person signing documents under this Part 5.16 shall make the following certification:

I certify under penalty of law that this document and all attachments were prepared under my direction or supervision in accordance with a system designed to assure that qualified personnel properly gathered and evaluated the information submitted. Based on my inquiry of the person or persons who manage the system, or those persons directly responsible for gathering the information, the information submitted is, to the best of my knowledge and belief, true, accurate, and complete. I am aware that there are significant penalties for submitting false information, including the possibility of fine and imprisonment for knowing violations.

- 5.16.2. If a document is to be signed electronically, the Division's rules regarding electronic transactions govern.

PART 6. DEFINITIONS

As used in this Permit:

- 6.1. "Act" means the "Utah Water Quality Act"
- 6.2. "Best Management Practices" ("BMPs") means schedules of activities, prohibitions of practices, maintenance procedures, and other management practices to prevent or reduce the discharge of pollutants to waters of the State. BMPs also include treatment requirements, operating procedures, and practices to control plant site runoff, spillage or leaks, sludge or waste disposal, or drainage from raw material storage.
- 6.3. "Common plan of development or sale" means one plan for development or sale, separate parts of which are related by any announcement, piece of documentation (including a sign, public notice or hearing, sales pitch, advertisement, drawing, plat, blueprint, contract, permit application, zoning request, computer design, etc.), physical demarcation (including boundary signs, lot stakes, surveyor markings, etc.), or continuing obligation (including contracts) that identify the scope of the project. A plan may still be a common plan of development or sale even if it is taking place in separate stages or phases, is planned in combination with other construction activities, or is implemented by different owners or operators.
- 6.4. "Commencement of Construction" means the initial disturbance of soils associated with clearing, grading, or excavating activities or other construction activities.
- 6.5. "Construction activity" means soil disturbing activities such as clearing, grading, and excavating of land. The term also includes construction support activities.
- 6.6. "Construction support activities" means construction material and equipment storage and maintenance, concrete or asphalt batch plants, except as provided in Part 1.4.3 of this Permit.
- 6.7. "Control Measure" refers to any Best Management Practice or other method used to prevent or reduce the discharge of pollutants to waters of the State.
- 6.8. "CWA" means Clean Water Act or the Federal Water Pollution Control Act.
- 6.9. "Dedicated portable asphalt plant" means a portable asphalt plant that is located on or contiguous to a construction site and that provides asphalt only to the construction site that the plant is located on or adjacent to.
- 6.10. "Dedicated portable concrete plant" means a portable concrete plant that is located on or contiguous to a construction site and that provides concrete only to the construction site that the plant is located on or adjacent to.
- 6.11. "Discharge," when used without qualification, means the discharge of a pollutant.

- 6.12. "EPA" means the United States Environmental Protection Agency.
- 6.13. "Eligible" means qualified for authorization to discharge storm water under this general permit.
- 6.14. "Executive Secretary" means Executive Secretary of the Utah Water Quality Board.
- 6.15. "Final Stabilization" means that all soil disturbing activities at the site have been completed, and that a uniform (e.g. evenly distributed, without large bare areas) perennial vegetative cover with a density of 70% of the native background vegetative cover for the area has been established on all unpaved areas and areas not covered by permanent structures, or equivalent permanent stabilization measures (such as the use of riprap, gabions, or geo-textiles) have been employed. In some parts of the country, background native vegetation will cover less than 100% of the ground (e.g. arid areas). Establishing at least 70% of the natural cover of native vegetation meets the vegetative cover criteria for final stabilization. For example, if the native vegetation covers 50% of the ground, 70% of 50% would require 35% total cover for final stabilization. For individual lots in residential construction, final stabilization means that either the homebuilder has completed final stabilization as specified above, or the homebuilder has established temporary stabilization including perimeter controls for an individual lot prior to occupation of the home by the homeowner and has obligated the homeowner, by contract, to complete the requirements for final stabilization within two years.
- 6.16. "Indian Country" is defined as in 40 CFR §122.2 to mean:
1. All land within the limits of any Indian reservation under the jurisdiction of the United States Government, notwithstanding the issuance of any patent, and, including rights-of-way running through the reservation;
 2. All dependent Indian communities within the borders of the United States whether within the originally or subsequently acquired territory thereof, and whether within or without the limits of a state; and
 3. All Indian allotments, the Indian titles to which have not been extinguished, including rights-of-ways running through the same.
- 6.17. "Municipal Separate Storm Sewer System" refers to all separate storm sewers that are owned or operated by the United States, a State, city, town, county, district, association, or other public body having jurisdiction over disposal of sewage, industrial wastes, storm water, or other wastes, including special districts under State law such as a sewer districts, flood control districts or drainage districts, or similar entity that discharges to waters of the State.
- 6.18. "NOI" means notice of intent to be covered by this Permit.
- 6.19. "NOT" means notice of termination.
- 6.20. "Point Source" means any discernible, confined, and discrete conveyance, including but not limited to, any pipe, ditch, channel, tunnel, conduit, well, discrete fissure, container, rolling stock, concentrated animal feeding operation, landfill leachate collection system,

vessel or other floating craft from which pollutants are or may be discharged. This term does not include return flows from irrigated agriculture or agricultural storm water runoff.

- 6.21. "Runoff coefficient" means the fraction of total rainfall that will appear at conveyance as runoff.
- 6.22. "Site" means the land or water area where any "facility or activity" is physically located or conducted, including adjacent land used in connection with the facility or activity.
- 6.23. "Storm water" means storm water runoff, snow melt runoff, and surface runoff and drainage.
- 6.24. "Storm water discharge associated with industrial activity" is defined in the Utah Administrative Code (UAC) R317-8-3.9(6)(c) & (d) and incorporated here by reference. Most relevant to this Permit is UAC R317-8-3.9(6)(d)10, which relates to construction activity including clearing, grading and excavation activities.
- 6.25. SWPPP means Storm Water Pollution Prevention Plan, referring to the plan required in Part 3 of this Permit.
- 6.26. "Total Maximum Daily Load" or "TMDL" means the sum of the individual wasteload allocations (WLAs) for point sources and load allocations (LAs) for nonpoint sources and natural background. If a receiving water has only one point source discharger, the TMDL is the sum of that point source WLA plus the LAs for any nonpoint sources of pollution and natural background sources, tributaries, or adjacent segments. TMDLs can be expressed in terms of either mass per time, toxicity, or other appropriate measure.
- 6.27. Waters of the State means all streams, lakes, ponds, marshes, water-courses, waterways, wells, springs, irrigation systems, drainage systems, and all other bodies or accumulations of water, surface and underground, natural or artificial, public or private, which are contained within, flow through, or border upon this state or any portion thereof, except that bodies of water confined to and retained within the limits of private property, and which do not develop into or constitute a nuisance, or a public health hazard, or a menace to fish and wildlife, shall not be considered to be waters of the state (UAC R317-1-1.31).

Appendix D - NOI

STATE OF UTAH, DEPARTMENT OF ENVIRONMENTAL QUALITY, DIVISION OF WATER QUALITY
195 North 1950 West, P.O. Box 144870, Salt Lake City, Utah 84114-4870 (801)536-4300

NOI

Notice of Intent (NOI) for Storm Water Discharges Associated with Construction Activity Under the UPDES General Permit No. UTR365583
SEE REVERSE FOR INSTRUCTIONS

Submission of this Notice of Intent constitutes notice that the party(s) identified in Section I of this form intends to be authorized by UPDES General Permit No. UTR365583 issued for storm water discharges associated with construction activity in the State of Utah. Becoming a permittee obligates such discharger to comply with the terms and conditions of the permit. ALL NECESSARY INFORMATION MUST BE PROVIDED ON THIS FORM.

Is this NOI seeking continuation for previously expired permit coverage at the same site? N (Y or N)
If yes, what is the number of the previous permit coverage? Permit No.

Permit Registration Date: 10/30/2013 Permit Start Date: 10/30/2013 Permit Expiration Date: 10/30/2014

I. OPERATOR INFORMATION

Name (Main operator): Lifestyle Homes Phone: 435-363-0100
Address: 45 North Main, Ste 101 Status of Owner/Operator: PRIVATE
City: LOGAN State: UT Zip: 84321
Contact Person: Chris Funk Phone: 435-994-2253

Name (1st Co-permittee): Lifestyle Homes Phone: 435-363-0100
Address: 45 N Main, Ste 101 Status of Owner/Operator: PRIVATE
City: LOGAN State: UT Zip: 84321
Contact Person: Jeremy Wilcock Phone: 435-757-1087

Name (2nd Co-permittee): Phone:
Address: Status of Owner/Operator:
City: State: UT Zip:
Contact Person: Phone:

Name (3rd Co-permittee): Phone:
Address: Status of Owner/Operator:
City: State: Zip:
Contact Person: Phone:

Please copy this form if you have more co-permittees than what is allowed on this form.

II. FACILITY SITE / LOCATION INFORMATION

Is the facility located in Indian Country?

Name: SC119 Nudd N (Y or N)

Project No. (if any):

Address: 4684 N Abbey Way County: WEBER

City: NORTH OGDEN State: UT Zip: 84310

Latitude: 41.042778 Longitude: 111.089722

Method (check one): USGS Topo Map, Scale _____ EPA Web site GPS Other

INSTRUCTIONS

Notice Of Intent (NOI) For Permit Coverage Under the UPDES General Permit For Storm Water Discharges From Construction Activities

Who Must File A Notice Of Intent (NOI) Form State law at UAC R317-8-3.9 prohibits point source discharges of storm water from construction activities to a water body(ies) of the State without a Utah Pollutant Discharge Elimination System (UPDES) permit. The operator of a construction activity that has such a storm water discharge must submit a NOI to obtain coverage under the UPDES Storm Water General Permit. If you have questions about whether you need a permit under the UPDES Storm Water program, or if you need information as to whether a particular program is administered by EPA or a state agency, contact the storm water coordinator at (801) 536-4300.

Where To File NOI Form NOIs, with fee payment(s), must be sent to the following address:

Department of Environmental Quality
Division of Water Quality
P.O. Box 144870
Salt Lake City, UT 84114-4870

(The NOI can also be completed on line at:
<http://www.waterquality.utah.gov/UPDES/stormwatercon.htm>)

Beginning of Coverage Storm Water General Permits are issued immediately after submitting an NOI with the permit fee. The permittee should be aware that though you may not have a permit in hand, if you have submitted a completed NOI with the permit fee you are covered by the conditions in the permit and will be expected to comply with permit conditions. If you wish, contact the Division of Water Quality at (801) 536-4300 to receive a copy of the permit or you can print a copy from the DWQ web site.

Permit Fees (MAKE CHECKS PAYABLE TO: DIVISION OF WATER QUALITY) The permit fee is \$110.00 per year. This fee is prorated on a yearly basis. For example if construction is scheduled for one year and one day the fee would be \$220.00 because construction went into a second year. The minimum fee is \$110.00 which gives one year of coverage. The fee must be received with the NOI before permit coverage is activated.

Length of Coverage: Construction Storm Water Permits start on the day that the NOI and fee payment is received at DWQ (on line if that is the case) and expire on the date that the fee is paid up to. The minimum fee is \$110, therefore all permits where the minimum fee is paid will automatically receive coverage for one year. When a project is completed and the permittee wishes to discontinue permit coverage, wants to be released from accountability for permit conditions, and has stabilized the site according to permit requirements the permittee must submit the a notice of termination (NOT). The site must be clean and all temporary storm water control measures must be removed. In most cases the DWQ or municipal (for the municipality of jurisdiction) storm water coordinator will perform a final inspection. If the site passes the final inspection the permit is terminated.

The Storm Water General Permit for Construction Activities UTR300000 will expire on June 30, 2013. The Clean Water Act requires that all UPDES permits be renewed every 5 years. If a project extends beyond the expiration date of the Permit it must continue coverage under the renewed permit that will subsequently be developed to continue the same or similar permit service for construction activity.

SECTION I - FACILITY OPERATOR INFORMATION. Give the legal name(s) of the person(s), firm(s), public organization(s), or any other entity(ies) that conducts the construction operation at the facility or site described in this application. The name of the operator(s) may be the developer, the owner, the general contractor, the design firm, the excavation contractor and/or others (e.g. anyone that fits the definition of operator). Most often it is the general contractor. An operator is anyone that has control over site/project specifications and/or control of day to day operational activities. Do not use a colloquial name.

Enter the complete address and telephone number of the operator(s). Enter the appropriate letter to indicate the legal status of the operator of the facility.

F = Federal M = Public (other than Fed or State) S = State P = Private

SECTION II - FACILITY/SITE LOCATION INFORMATION. Enter the facility name or legal name and project number (if any) of the site and complete street address, including city, state and ZIP code. The latitude and longitude of the facility must be included to the approximate centroid of the site, and the method of how the Lat/Long was obtained (USGS maps, GPS, Internet Map sites [such as Google Earth], other). The township and range is desirable but not necessary.

Indicate whether the facility is located in Indian Country. If the facility is located in Indian Country, do not complete this NOI, instead complete form 3510-6 and submit to EPA Region VIII except for facilities on the Navajo Reservation or on the Goshute Reservation which should submit EPA form 3510-6 to Region IX.

SECTION III - SITE ACTIVITY INFORMATION If the storm water discharges to a municipal separate storm sewer system (MS4), enter the name of the operator of the MS4 (e.g., municipality name, county name) and the receiving water of the discharge from the MS4 if it is known (if it is not known please estimate or guess and indicate so). (An MS4 is defined as a conveyance or system of conveyances (including roads with drainage systems, municipal streets, catch basins, curbs, gutters, ditches, man-made channels, or storm drains) that is owned or operated by a state, city, town, county, district, association or other public body which is designed or used for collecting or conveying storm water).

SECTION IV - TYPE OF CONSTRUCTION. Check each type of construction that applies to this application.

SECTION V - BEST MANAGEMENT PRACTICES. Check each type of best management practice that will be used to control storm water runoff at the job site.

SECTION VI - ADDITIONAL. Provide an estimate of the total number of acres of the site on which soil will be disturbed (round to the nearest acre). Indicate whether the storm water pollution prevention plan for the site is in compliance with approved state and/or local sediment and erosion plans, permits, or storm water management plans. An email address is required of the best contact associated with the project for the communication needs of DWQ.

SECTION VII - CERTIFICATION. State statutes provide for severe penalties for submitting false information on this application form. State regulations require this application to be signed as follows:

For a corporation: by a responsible corporate officer, which means: (i) president, secretary, treasurer, or vice-president of the corporation in charge of a principal business function, or any other person who performs similar policy or decision making functions, or (ii) the manager of one or more manufacturing, production, or operating facilities employing more than 250 persons or having gross annual sales or expenditures exceeding \$25 million (in second quarter 1980 dollars), if authority to sign documents has been assigned or delegated to the manager in accordance with corporate procedures;

For a partnership or sole proprietorship: by a general partner or the proprietor, or

For a municipality, state, Federal, or other public facility: by either a principal executive officer or ranking elected official.

POLLUTION PREVENTION PLAN A storm water pollution prevention plan (SWP3) is required to be in hand before the NOI can be submitted. It is important to know SWP3 requirements (contained in the permit) even during the design portion of the project. A copy of the permit can be obtained from the Division of Water Quality's storm water construction web site. Guidance material for developing a SWP3 can be obtained from EPA (NTIS) or from the Division of Water Quality's storm water construction web site.

III. SITE ACTIVITY INFORMATION

Municipal Separate Storm Sewer System (MS4) Operator Name: Weber County

Receiving Water Body: Pineview Res guess

How far to the nearest water body? 5 miles

Is this a sensitive Water Body? No

List the Number of any other UPDES permits at the site:

IV. TYPE OF CONSTRUCTION (Check all that apply)

- 1. Residential
- 2. Commercial
- 3. Industrial
- 4. Road
- 5. Bridge
- 6. Utility
- 7. Contouring, Landscaping
- 8. Other (Please list)

V. BEST MANAGEMENT PRACTICES

Identify proposed Best Management Practices (BMPs) to reduce pollutants in storm water discharges: (Check all that apply)

- 1. Silt Fences
- 2. Sediment Pond
- 3. Seeding/Preservation of Vegetation
- 4. Mulching/Geotextiles
- 5. Check Dams
- 6. Structural Controls (Berms, Ditches, etc.)
- 7. Other (Please list)

VI. ADDITIONAL INFORMATION REQUIRED

Estimated Area to be Disturbed (in Acres): 1

Total Acreage: 1

A storm water pollution prevention plan has been prepared for this site and is to the best of my knowledge in Compliance with State and/or Local Sediment and Erosion Plans and Requirements. Y (Y or N)

(A pollution prevention plan is required to be on hand before submittal of the NOI.)

Enter the best e-mail address for contacting the permittee: jeremy@buildwithlifestyle.com

VII. CERTIFICATION: I certify under penalty of law that I have read and understand the *Part 1* eligibility requirements for coverage under the general permit for storm water discharges from construction activities. I further certify that to the best of my knowledge, all discharges and BMPs that have been scheduled and detailed in a pollution prevention plan will satisfy requirements of *Part 1*, and *Part 3* of this permit. I understand that continued coverage under this storm water general permit is contingent upon maintaining eligibility as provided for in *Part 1*.

I also certify under penalty of law that this document and all attachments were prepared under the direction or supervision of those who have placed their signature below, in accordance with a system designed to assure that qualified personnel properly gather and evaluate the information submitted. Based on my inquiry of the person or persons who manage the system, or those persons directly responsible for gathering the information, the information submitted is, to the best of my knowledge and belief, true, accurate, and complete. I am aware that there are significant penalties for submitting false information, including the possibility of fine and imprisonment for knowing violations.

Title: Production Manager

Print Name (of responsible person for the main operator from first page):

Lifestyle Homes

Signature: 

Date:

10/30/2013

Print Name (of responsible person for the 1st co-permittee from first page):

Lifestyle Homes

Signature: 

Date:

10/30/2013

Print Name (of responsible person for the 2nd co-permittee from first page):

Signature: _____

Date:

Print Name (of responsible person for the 3rd co-permittee from first page):

Signature: _____

Date:

Amount of Permit Fee Enclosed: \$ 150.00

Appendix F – *Sample* Corrective Action Log

Project Name:
SWPPP Contact:

Inspection Date	Inspector Name(s)	Description of BMP Deficiency	Corrective Action Needed (including planned date/responsible person)	Date Action Taken/Responsible person

Appendix G – *Sample* SWPPP Amendment Log

Project Name:
SWPPP Contact:

Amendment No.	Description of the Amendment	Date of Amendment	Amendment Prepared by [Name(s) and Title]

Appendix H – *Sample* Subcontractor Certifications/Agreements

SUBCONTRACTOR CERTIFICATION STORMWATER POLLUTION PREVENTION PLAN

Project Number: _____

Project Title: _____

Operator(s): _____

As a subcontractor, you are required to comply with the Stormwater Pollution Prevention Plan (SWPPP) for any work that you perform on-site. Any person or group who violates any condition of the SWPPP may be subject to substantial penalties or loss of contract. You are encouraged to advise each of your employees working on this project of the requirements of the SWPPP. A copy of the SWPPP is available for your review at the office trailer.

Each subcontractor engaged in activities at the construction site that could impact stormwater must be identified and sign the following certification statement:

I certify under the penalty of law that I have read and understand the terms and conditions of the SWPPP for the above designated project and agree to follow the BMPs and practices described in the SWPPP.

This certification is hereby signed in reference to the above named project:

Company: _____

Address: _____

Telephone Number: _____

Type of construction service to be provided: _____

Signature: _____

Title: _____

Date: _____

Appendix I – *Sample* Grading and Stabilization Activities Log

Project Name:
SWPPP Contact:

Date Grading Activity Initiated	Description of Grading Activity	Date Grading Activity Ceased (Indicate Temporary or Permanent)	Date When Stabilization Measures are Initiated	Description of Stabilization Measure and Location

Appendix J – *Sample* SWPPP Training Log

Stormwater Pollution Prevention Training Log

Project Name:

Project Location:

Instructor's Name(s):

Instructor's Title(s):

Course Location: _____ Date: _____

Course Length (hours): _____

Stormwater Training Topic: *(check as appropriate)*

- Erosion Control BMPs Emergency Procedures
 Sediment Control BMPs Good Housekeeping BMPs
 Non-Stormwater BMPs

Specific Training Objective: _____

Attendee Roster: *(attach additional pages as necessary)*

No.	Name of Attendee	Company
1		
2		
3		
4		
5		
6		
7		
8		
9		
10		

Appendix K – *Sample* Delegation of Authority Form

Delegation of Authority

I, Jeremy Wilcock (name), hereby designate the person or specifically described position below to be a duly authorized representative for the purpose of overseeing compliance with environmental requirements, including the Construction General Permit, at the 4684 N Abbey Way, Eden UT construction site. The designee is authorized to sign any reports, stormwater pollution prevention plans and all other documents required by the permit.

Chris Funk (name of person or position)
Lifestyle Homes (company)
45 N Main Ste 101 (address)
Logan, UT, 84321 (city, state, zip)
435-363-0100 (phone)

By signing this authorization, I confirm that I meet the requirements to make such a designation as set forth in UTR365583 (Reference State Permit), and that the designee above meets the definition of a “duly authorized representative” as set forth in UTR365583 (Reference State Permit).

I certify under penalty of law that this document and all attachments were prepared under my direction or supervision in accordance with a system designed to assure that qualified personnel properly gathered and evaluated the information submitted. Based on my inquiry of the person or persons who manage the system, or those persons directly responsible for gathering the information, the information submitted is, to the best of my knowledge and belief, true, accurate, and complete. I am aware that there are significant penalties for submitting false information, including the possibility of fine and imprisonment for knowing violations.

Name: Jeremy Wilcock

Company: Lifestyle Homes

Title: Vice President

Signature:  _____

Date: 10/30/2013

BMP: Earth Berm Barrier

EB

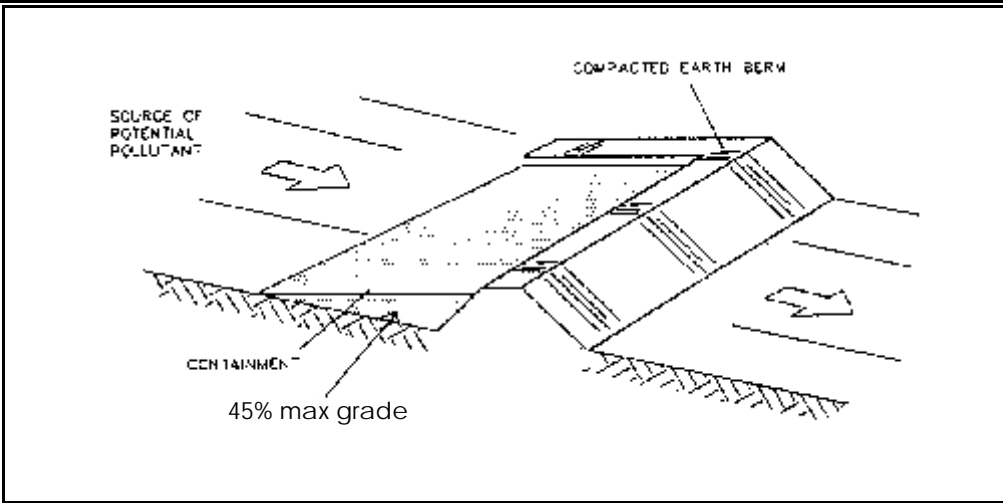

DESCRIPTION:

A temporary containment control constructed of compacted soil.

APPLICATION:

- < Construct around waste and materials storage area.
- < Construct around staging and maintenance areas.
- < Construct around vehicle parking and servicing areas.

INSTALLATION/APPLICATION CRITERIA:

- < Construct an earthen berm down hill of the area to be controlled. The berm should surround fueling facilities and maintenance areas on three sides to provide containment.
- < Berm needs to be a minimum of 1 foot tall by 1 foot wide and be compacted by earth moving equipment.

LIMITATIONS:

- < Not effective on steep slopes.
- < Limits access to controlled area.
- < Personnel need to quickly respond to spills with remedial actions.

MAINTENANCE:

- < Observe daily for any non-stormwater discharge.
- < Look for runoff bypassing ends of berms or undercutting berms.
- < Repair or replace damaged areas of the berm and remove accumulated sediment.
- < Recompact soil around berm as necessary to prevent piping.

OBJECTIVES

- Housekeeping Practices
- Contain Waste
- Minimize Disturbed Areas
- Stabilize Disturbed Areas
- Protect Slopes/Channels
- Control Site Perimeter
- Control Internal Erosion



SALT LAKE COUNTY

ENGINEERING DIVISION

2001 S. State Street #N3300

Salt Lake City, UT 84190-4600

Tel (801) 468-2711

TARGETED POLLUTANTS

- Sediment
- Nutrients
- Toxic Materials
- Oil & Grease
- Floatable Materials
- Other Construction Waste

- High Impact
- Medium Impact
- Low or Unknown Impact

IMPLEMENTATION REQUIREMENTS

- Capital Costs
- O&M Costs
- Maintenance
- Training

- High
- Medium
- Low

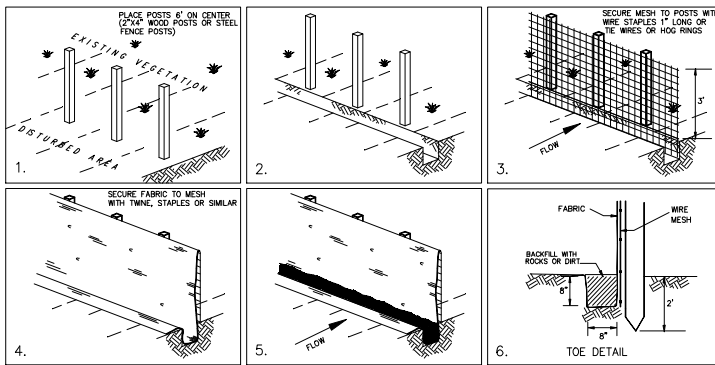

DESCRIPTION:

A temporary sediment barrier consisting of entrenched filter fabric stretched across and secured to supporting posts.

APPLICATION:

- < Perimeter control: place barrier at downgradient limits of disturbance
- < Sediment barrier: place barrier at toe of slope or soil stockpile
- < Protection of existing waterways: place barrier at top of stream bank
- < Inlet protection: place fence surrounding catchbasins

INSTALLATION/APPLICATION CRITERIA:

- < Place posts 6 feet apart on center along contour (or use preassembled unit) and drive 2 feet minimum into ground. Excavate an anchor trench immediately upgradient of posts.
- < Secure wire mesh (14 gage min. With 6 inch openings) to upslope side of posts. Attach with heavy duty 1 inch long wire staples, tie wires or hog rings.
- < Cut fabric to required width, unroll along length of barrier and drape over barrier. Secure fabric to mesh with twine, staples, or similar, with trailing edge extending into anchor trench.
- < Backfill trench over filter fabric to anchor.

LIMITATIONS:

- < Recommended maximum drainage area of 0.5 acre per 100 feet of fence
- < Recommended maximum upgradient slope length of 150 feet
- < Recommended maximum uphill grade of 2:1 (50%)
- < Recommended maximum flow rate of 0.5 cfs
- < Ponding should not be allowed behind fence

MAINTENANCE:

- < Inspect immediately after any rainfall and at least daily during prolonged rainfall.
- < Look for runoff bypassing ends of barriers or undercutting barriers.
- < Repair or replace damaged areas of the barrier and remove accumulated sediment.
- < Reanchor fence as necessary to prevent shortcutting.
- < Remove accumulated sediment when it reaches 1/2 the height of the fence.

OBJECTIVES

- Housekeeping Practices
- Contain Waste
- Minimize Disturbed Areas
- Stabilize Disturbed Areas
- Protect Slopes/Channels
- Control Site Perimeter
- Control Internal Erosion



SALT LAKE COUNTY

ENGINEERING DIVISION

2001 S. State Street #N3300

Salt Lake City, UT 84190-4600

Tel (801) 468-2711

TARGETED POLLUTANTS

- Sediment
- Nutrients
- Toxic Materials
- Oil & Grease
- Floatable Materials
- Other Waste

- High Impact
- Medium Impact
- Low or Unknown Impact

IMPLEMENTATION REQUIREMENTS

- Capital Costs
- O&M Costs
- Maintenance
- Training

- High
- Medium
- Low

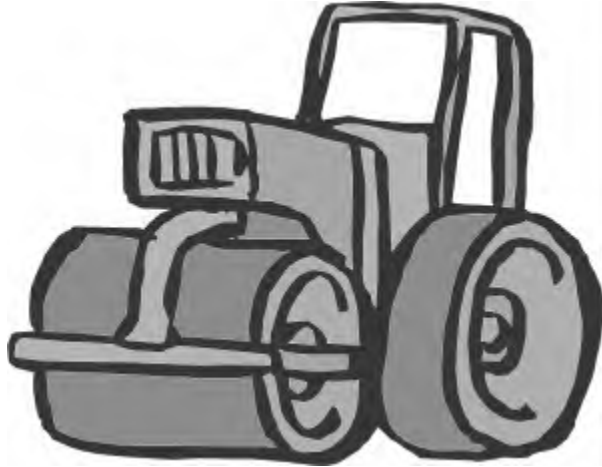

DESCRIPTION:

Use of rolling, tamping, or vibration to stabilize fill materials and control erosion by increasing the soil density. Increasing the density of soil improves soil strength, reduces long-term soil settlement, and provides resistance to erosion.

APPLICATIONS:

- < Stabilize fill material placed around various structures.
- < Improve soil in place as foundation support for roads, parking lots, and buildings.

INSTALLATION/APPLICATION CRITERIA:

- < Make sure soil moisture content is at optimum levels.
- < Use proper compaction equipment.
- < Install sediment control and storm water management devices below compacted areas and runoff interceptor devices above these areas. Drainage from compacted areas must be carefully planned to protect adjacent uncompacted soils.
- < The surface of compacted areas should be scarified and seeded or mulched and seeded to increase the effectiveness of compaction.

LIMITATIONS:

- < Compaction tends to increase runoff.
- < Over-compaction will hamper revegetation efforts.

MAINTENANCE:

No maintenance required.

OBJECTIVES

- Housekeeping Practices
- Contain Waste
- Minimize Disturbed Areas
- Stabilize Disturbed Areas
- Protect Slopes/Channels
- Control Site Perimeter
- Control Internal Erosion



SALT LAKE COUNTY
 ENGINEERING DIVISION
 2001 S. State Street #N3300
 Salt Lake City, UT 84190-4600
 Tel (801) 468-2711

TARGETED POLLUTANTS

- Sediment
- Nutrients
- Toxic Materials
- Oil & Grease
- Floatable Materials
- Other Waste

- High Impact
- Medium Impact
- Low or Unknown Impact

IMPLEMENTATION REQUIREMENTS

- Capital Costs
- O&M Costs
- Maintenance
- Training

- High Medium Low