



Staff Report to the Weber County Commission

Weber County Planning Division

Synopsis

Application Information

Application Request: Consideration and action for the final plat approval of Village Nests at Powder Mountain, a Condominium Plat, including a Subdivision Improvement Agreement with the Financial Guarantee.

Type of Decision: Administrative

Agenda Date: Tuesday, February 02, 2016

Applicant: Summit Mountain Holding Group, LLC

File Number: UVS92004DP

Property Information

Approximate Address: Powder Mountain Ski Resort (Daybreak Ridge)

Project Area: 1.38 Acre (20 Nest Units)

Zoning: Ogden Valley Destination and Recreation Resort Zone DRR-1

Existing Land Use: Ski Resort

Proposed Land Use: Residential Condominium Subdivision

Parcel ID: 23-012-0022

Township, Range, Section: T7N, R2E, Section 8

Adjacent Land Use

| | |
|--------------------------|--------------------------|
| North: Ski Resort | South: Ski Resort |
| East: Ski Resort | West: Ski Resort |

Staff Information

Report Presenter: Ronda Kippen
rkippen@co.weber.ut.us
 801-399-8768

Report Reviewer: SM

Applicable Ordinances

- Title 101, Chapter 1, General Provisions, Section 7, Definitions
- Title 104, Chapter 29 Ogden Valley Destination and Recreation Resort Zone (DRR-1)
- Title 104, Zones, Chapter 28, Ogden Valley Sensitive Lands Overlay Districts
- Title 106, Subdivisions, Chapter 1-8 as applicable

Summary

The applicant has submitted an application for approval of the Village Nests at Powder Mountain, a Condominium Plat, which is a phase within an approved PRUD, consisting of one lot with 20 “Nest Units” (see Exhibit A for the proposed condominium plat). The project area is part of the proposed Summit Eden Phase 1D, Amendment 1 Subdivision identified as “Development Parcel D5R” (see Exhibit B for the proposed Summit Eden Phase 1D, Amendment 1 Subdivision).

Part of the consideration and action to be made by the County Commission is a Subdivision Improvement Agreement including a Financial Guarantee in the amount of \$498,085.36 (see Exhibit C for the Subdivision Improvement Agreement) for the proposed subdivision. The funds for this phase of the Summit Development will be taken from the remaining balance of the original escrow funds held by Weber County for Summit Eden Phases 1A-1D. The Summit Eden escrow account currently has a balance of \$216,326.36. Based on the amendment to Summit Eden Phase 1D, \$281,759.00 will be added back into the Summit Eden escrow account resulting in a balance of \$498,085.36 which will then be allocated to the Village Nests at Powder Mountain, a Condominium Plat, and the Summit Eden escrow account will no longer have a remaining balance.

The applicant made application in 2013 and received the required subsequent approvals; however, the applicant did not record the final plat. The applicant would like to move forward with the recording process and has reinstated the 2013 application as well as changed the subdivision name from Summit Eden Village Nests Condominiums to Village Nests at

Powder Mountain, a Condominium Plat. Due to timeframes that are outlined in the Uniform Land Use Code of Weber County (LUC) §106-1-7, this application must go through the approval procedure prior to recording the condominium plat and is being forwarded to County Commission for final approval after receiving a positive recommendation from the Ogden Valley Planning Commission on January 5, 2016 (see Exhibit D for the OVPC draft minutes) per the approval process outlined in LUC §106-1-8.

Background

Summit Eden Village Nests Condominiums received preliminary subdivision approval in conjunction with the County Commission's approval of the Summit at Powder Mountain PRUD on April 9, 2013 with subsequent amendments on July 9, 2013. This application was previously heard and received a positive recommendation by the Ogden Valley Planning Commission on October 22, 2013 and received approval by the Weber County Commission on January 21, 2014 (see Exhibit E for the PC and CC minutes). A time extension was granted by the Weber County Planning Director on October 16, 2014 (see Exhibit F).

The proposed subdivision amendment and lot configuration is in conformance with the approved PRUD, current zoning and the Zoning Development Agreement Master Plan (see Exhibit G) as well as the applicable subdivision requirements as required in the LUC. The following is staff's analysis of the proposed subdivision amendment.

Analysis

General Plan: The proposal conforms to the Ogden Valley General Plan by encouraging development within the existing resort-related commercial areas.

Zoning: The subject property is located in the Ogden Valley Destination and Recreation Resort Zone more particularly described as the DRR-1 zone. The purpose and intent of the DRR-1 zone is identified in the LUC §104-29-1 as:

"The purpose of this chapter is to provide flexible development standards to resorts that are dedicated to preserving open space and creating extraordinary recreational resort experiences while promoting the goals and objectives of the Ogden Valley general plan. It is intended to benefit the residents of the county and the resorts through its ability to preserve the valley's rural character, by utilizing a mechanism that allows landowners to voluntarily transfer development rights to areas that are more suitable for growth when compared to sensitive land areas such as wildlife habitats, hazardous hillsides or prime agricultural parcels. Resorts that lie within an approved destination and recreation resort zone shall, by and large, enhance and diversify quality public recreational opportunities, contribute to the surrounding community's well-being and overall, instill a sense of stewardship for the land."

As part of the subdivision process, the proposal has been reviewed against the current subdivision ordinance in LUC §106, the approved PRUD and the standards in the DRR-1 zone in LUC §104-29. The proposal has been reviewed against the adopted zoning and subdivision ordinances to ensure that the regulations and standards have been adhered to. It appears that the proposed subdivision is in conformance with county code. The following is a brief synopsis of the review criteria and conformance with the LUC.

Lot area, frontage/width and yard regulations: In order to allow for private ownership of the units, this phase is being developed as a condominium project. Private ownership is limited to the actual footprint and air space of each unit; the remainder of Development Parcel D5R is designated as common area. The landscaping plans for the common area were approved with the PRUD. All of the units have the same basic floor plan and footprint with minor variations. The building elevations and floor plans are included with the condominium plat and do comply with the architectural renderings approved with the PRUD.

Development Parcel D5R has access from Daybreak Ridge (a private road). Parking for the units is provided in garages. Units 1-8 have two-car garages beneath and there are two stand-alone two-car garages provided as well. The two-car garages in Units 1-8 provide one space for the nest unit to which they are attached and one space for another unit as designated on the subdivision plat. Using this method there are sufficient parking spaces for the nest units on Development Parcel D5R. The stand-alone garages were shown as four-car garages in the PRUD approval.

Flood Plain: The proposed subdivision is located in a Zone "D" as determined by FEMA to be an area of undetermined flood hazards. Areas designated as Zone "D" are typically areas in which no analysis of flood hazards has been conducted.

Culinary water and sanitary sewage disposal: Culinary water and sewer service are provided by Powder Mountain Water and Sewer Improvement District.

Review Agencies: The Weber County Surveyor’s Office and the Weber Fire District have reviewed and approved the proposal. The Weber County Engineering Division has reviewed the proposal and the applicant has addressed the areas of concern. Final approval from the Engineering Division is forthcoming. The conditions of approval from the original PRUD remain in effect (see Exhibit H). .

Additional design standards and requirements: Pathways for the overall Powder Mountain development were approved with the PRUD. As part of the PRUD approval, units to be used for timeshares or nightly rentals must be shown. The designation can be accomplished with a note on the dedication plat (see note 17 on the proposed plat) and approval from the Planning and County Commission.

Tax clearance: The 2015 property taxes have been paid in full. The 2016 property taxes will be due in full on November 1, 2016.

Public Notice: The required noticing for the final subdivision plat approval has been mailed to all property owners of record within 500 feet of the subject property regarding the proposed subdivision per noticing requirements outlined in LUC §106-1-6(b).

Summary of County Commission Considerations

- Does this subdivision meet the requirements of applicable County Land Use Codes?
- Does this subdivision comply with the applicable PRUD approvals?
- Does this subdivision comply with the applicable Zoning Development Agreement Master Plan approval?

Planning Commission Recommendation

The Ogden Valley Planning Commission has forwarded a positive recommendation for final plat approval of Village Nests at Powder Mountain, a Condominium Plat, consisting of one lot with 20 “Nest Units” as part of the previously approved PRUD. This recommendation for approval is subject to all review agency requirements and based on the following conditions:

1. Requirements of the Weber County Engineering Division.
2. Requirements of the Weber-Morgan Health Department.
3. Requirements of the Weber Fire District.
4. Requirements of the Weber County Surveyor’s Office.
5. Requirements of the Weber County Recorder.

This recommendation is based on the following findings:

1. The proposed subdivision conforms to the Ogden Valley General Plan.
2. With the recommended conditions, the proposed subdivision complies with all previous approvals and the applicable County ordinances.
3. The proposed subdivision will not be detrimental to the public health, safety, or welfare.
4. The proposed subdivision will not deteriorate the environment of the general area so as to negatively impact surrounding properties and uses.

Planning Division’s Recommendation

The Planning Division’s has forwarded a positive recommendation for final plat approval of Village Nests at Powder Mountain, a Condominium Plat, and is subject to all of the Planning Commission’s conditions of approval and includes the following additional conditions:

1. Prior to the commencement of work/construction for the Village Nests at Powder Mountain, a Hillside Review will be required, if deemed necessary by the applicable review agencies.

Exhibits

- A. Proposed Village Nests at Powder Mountain, a Condominium Plat
- B. Proposed Summit Eden Phase 1D Subdivision Plat, Amendment 1
- C. Weber County Subdivision Improvement Agreement
 - A. Property Description
 - B. Required On and Off Site Subdivision Improvements
 - C. Financial Guarantee
- D. Draft Minutes from PC meeting January 5, 2016
- E. Minutes from the Oct 22, 2013 PC meeting and Jan 21, 2014 CC meeting
- F. Administratively Approved time extension
- G. PRUD site plan and Zoning Development Master Plan
- H. List of PRUD conditions of approval

Location Map 1



Location Map 2

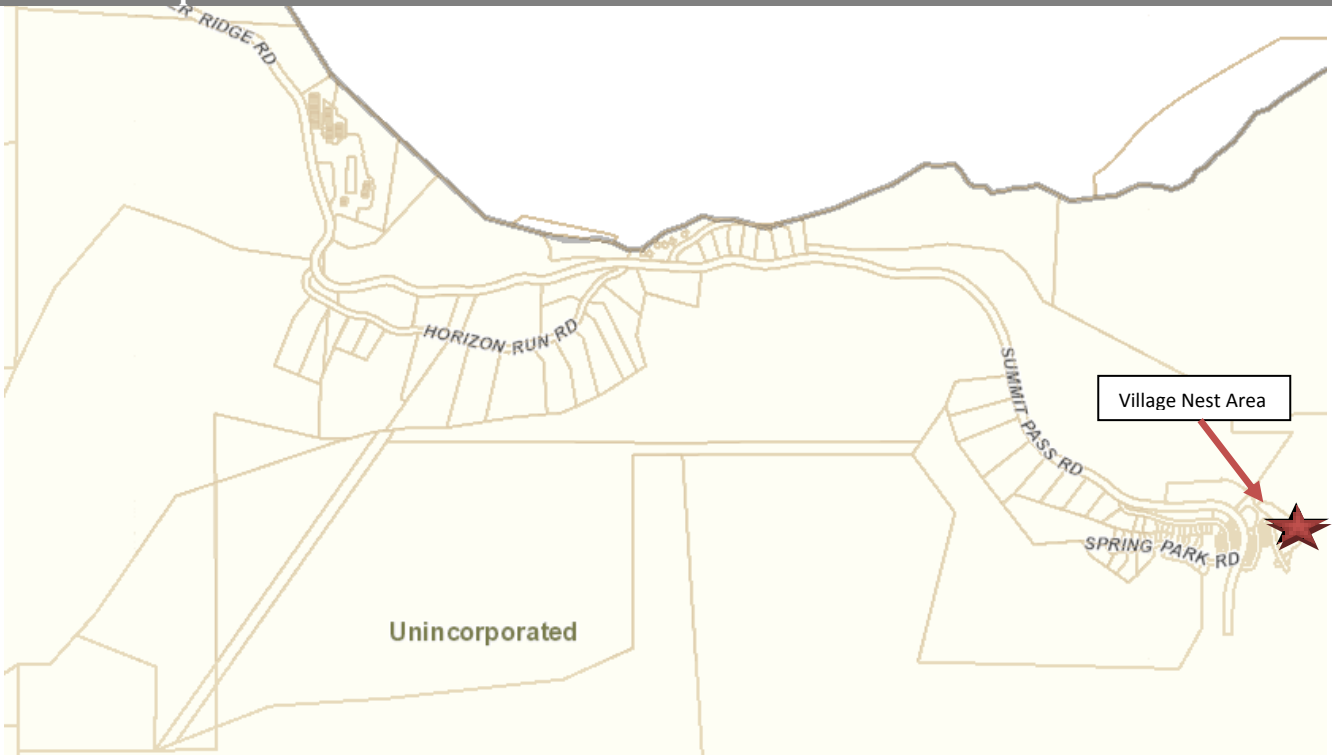

VILLAGE NESTS AT POWDER MOUNTAIN

LOCATED IN THE NORTHEAST QUARTER OF SECTION 8,
TOWNSHIP 7 NORTH, RANGE 2 EAST,
SALT LAKE BASE, AND MERIDIAN
JANUARY 2016

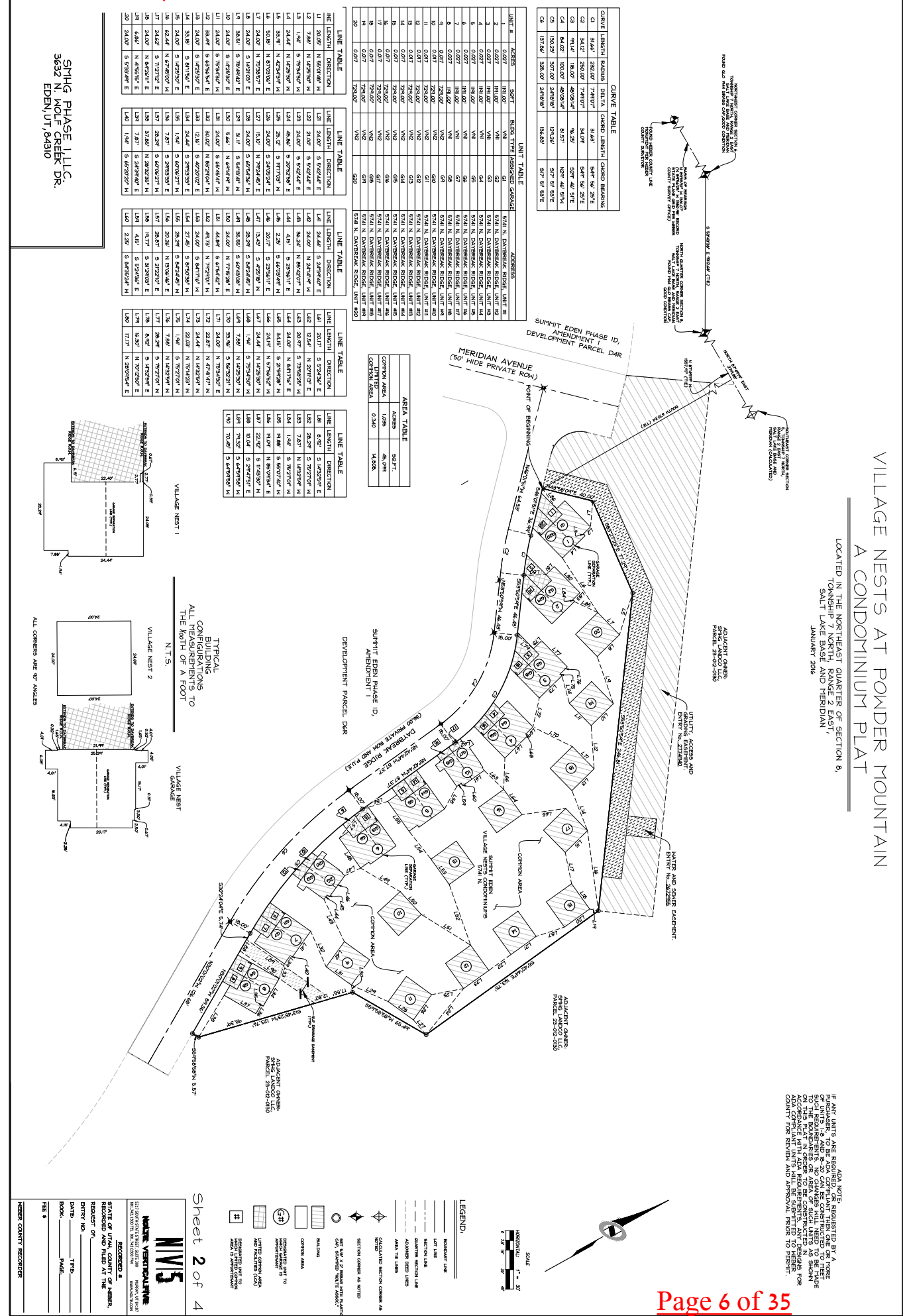

| CURVE LENGTH | RADIUS | CHIRLA | CURVE LENGTH | CHORD BEARING |
|--------------|--------|---------|--------------|-----------------|
| C1 | 34.67 | 232.00' | 24.90' | S 49° 48' 20" E |
| C2 | 34.67 | 232.00' | 24.90' | S 49° 48' 20" E |
| C3 | 34.67 | 182.00' | 48.00' | S 49° 48' 20" E |
| C4 | 34.67 | 182.00' | 48.00' | S 49° 48' 20" E |
| C5 | 130.93 | 307.00' | 218.34' | S 77° 51' 58" E |
| C6 | 137.64 | 308.00' | 219.93' | S 77° 51' 58" E |

| UNIT # | ACRES | SOFT | RDC TYPE | ASSIGNED GARAGE | ADDRESS |
|--------|-------|---------|----------|-----------------|------------------------------------|
| 1 | 0.027 | 110.00' | VNI | C1 | 5724 N. DAVENBRACK RIDGE, UNIT #1 |
| 2 | 0.027 | 110.00' | VNI | C2 | 5724 N. DAVENBRACK RIDGE, UNIT #2 |
| 3 | 0.027 | 110.00' | VNI | C3 | 5724 N. DAVENBRACK RIDGE, UNIT #3 |
| 4 | 0.027 | 110.00' | VNI | C4 | 5724 N. DAVENBRACK RIDGE, UNIT #4 |
| 5 | 0.027 | 110.00' | VNI | C5 | 5724 N. DAVENBRACK RIDGE, UNIT #5 |
| 6 | 0.027 | 110.00' | VNI | C6 | 5724 N. DAVENBRACK RIDGE, UNIT #6 |
| 7 | 0.027 | 110.00' | VNI | C7 | 5724 N. DAVENBRACK RIDGE, UNIT #7 |
| 8 | 0.027 | 110.00' | VNI | C8 | 5724 N. DAVENBRACK RIDGE, UNIT #8 |
| 9 | 0.017 | 75.00' | VND | 50 | 5724 N. DAVENBRACK RIDGE, UNIT #9 |
| 10 | 0.017 | 75.00' | VND | 51 | 5724 N. DAVENBRACK RIDGE, UNIT #10 |
| 11 | 0.017 | 75.00' | VND | 52 | 5724 N. DAVENBRACK RIDGE, UNIT #11 |
| 12 | 0.017 | 75.00' | VND | 53 | 5724 N. DAVENBRACK RIDGE, UNIT #12 |
| 13 | 0.017 | 75.00' | VND | 54 | 5724 N. DAVENBRACK RIDGE, UNIT #13 |
| 14 | 0.017 | 75.00' | VND | 55 | 5724 N. DAVENBRACK RIDGE, UNIT #14 |
| 15 | 0.017 | 75.00' | VND | 56 | 5724 N. DAVENBRACK RIDGE, UNIT #15 |
| 16 | 0.017 | 75.00' | VND | 57 | 5724 N. DAVENBRACK RIDGE, UNIT #16 |
| 17 | 0.017 | 75.00' | VND | 58 | 5724 N. DAVENBRACK RIDGE, UNIT #17 |
| 18 | 0.017 | 75.00' | VND | 59 | 5724 N. DAVENBRACK RIDGE, UNIT #18 |
| 19 | 0.017 | 75.00' | VND | 60 | 5724 N. DAVENBRACK RIDGE, UNIT #19 |
| 20 | 0.017 | 75.00' | VND | 61 | 5724 N. DAVENBRACK RIDGE, UNIT #20 |

| AREA | ACRES | SQ. FT. |
|-------------|-------|---------|
| COMMON AREA | 1.998 | 46,298 |
| TOTAL AREA | 0.340 | 14,908 |

| LINE LENGTH | DIRECTION | LINE LENGTH | DIRECTION | LINE LENGTH | DIRECTION |
|-------------|-----------|-------------|-----------|-------------|-----------|
| L1 | 20.00' | S | 65.9144' | E | |
| L2 | 7.80' | N | 14.7929' | N | |
| L3 | 1.44' | N | 1.7929' | N | |
| L4 | 24.44' | N | 1.7929' | N | |
| L5 | 36.30' | N | 4.2394' | E | |
| L6 | 50.80' | N | 4.2394' | E | |
| L7 | 24.00' | N | 8.7594' | E | |
| L8 | 24.00' | N | 8.7594' | E | |
| L9 | 38.50' | N | 1.7929' | E | |
| L10 | 24.00' | N | 1.7929' | E | |
| L11 | 24.00' | N | 6.9568' | N | |
| L12 | 53.84' | N | 6.9568' | N | |
| L13 | 24.00' | N | 1.7929' | E | |
| L14 | 33.00' | N | 8.7594' | E | |
| L15 | 62.44' | N | 8.7594' | E | |
| L16 | 24.00' | N | 1.7929' | E | |
| L17 | 24.00' | N | 4.2394' | E | |
| L18 | 6.84' | N | 1.7929' | E | |
| L19 | 24.00' | N | 8.7594' | E | |
| L20 | 24.00' | N | 8.7594' | E | |

| LINE LENGTH | DIRECTION | LINE LENGTH | DIRECTION | LINE LENGTH | DIRECTION |
|-------------|-----------|-------------|-----------|-------------|-----------|
| L41 | 24.44' | S | 2.4394' | E | |
| L42 | 24.00' | N | 2.4394' | N | |
| L43 | 38.24' | N | 8.7594' | E | |
| L44 | 4.80' | N | 2.4394' | E | |
| L45 | 20.17' | N | 4.2394' | E | |
| L46 | 24.44' | S | 2.4394' | E | |
| L47 | 18.40' | S | 2.4394' | E | |
| L48 | 28.28' | S | 6.4246' | N | |
| L49 | 35.50' | S | 6.4246' | N | |
| L50 | 24.00' | N | 7.7594' | N | |
| L51 | 44.80' | S | 6.9568' | N | |
| L52 | 44.80' | N | 7.7594' | N | |
| L53 | 24.00' | S | 4.2394' | E | |
| L54 | 24.00' | S | 8.7594' | E | |
| L55 | 24.00' | S | 8.7594' | E | |
| L56 | 28.28' | N | 1.7929' | E | |
| L57 | 28.28' | N | 4.2394' | E | |
| L58 | 4.80' | S | 1.7929' | E | |
| L59 | 11.70' | N | 8.7594' | E | |
| L60 | 2.50' | S | 6.9568' | N | |

| LINE LENGTH | DIRECTION | LINE LENGTH | DIRECTION | LINE LENGTH | DIRECTION |
|-------------|-----------|-------------|-----------|-------------|-----------|
| L61 | 8.40' | S | 1.7929' | E | |
| L62 | 32.34' | N | 2.4394' | N | |
| L63 | 20.17' | N | 2.4394' | N | |
| L64 | 1.44' | N | 1.7929' | N | |
| L65 | 18.40' | N | 1.7929' | N | |
| L66 | 18.40' | N | 8.7594' | E | |
| L67 | 22.40' | S | 1.7929' | E | |
| L68 | 10.04' | S | 2.4394' | E | |
| L69 | 70.80' | S | 6.4246' | N | |
| L70 | 35.50' | S | 6.4246' | N | |
| L71 | 24.00' | N | 8.7594' | N | |
| L72 | 22.40' | N | 8.7594' | N | |
| L73 | 24.00' | N | 8.7594' | N | |
| L74 | 24.00' | N | 8.7594' | N | |
| L75 | 18.40' | N | 8.7594' | N | |
| L76 | 18.40' | N | 8.7594' | N | |
| L77 | 28.28' | S | 1.7929' | E | |
| L78 | 28.28' | S | 4.2394' | E | |
| L79 | 4.80' | S | 1.7929' | E | |
| L80 | 11.70' | N | 8.7594' | E | |

| LINE LENGTH | DIRECTION | LINE LENGTH | DIRECTION | LINE LENGTH | DIRECTION |
|-------------|-----------|-------------|-----------|-------------|-----------|
| L81 | 8.40' | S | 1.7929' | E | |
| L82 | 32.34' | N | 2.4394' | N | |
| L83 | 20.17' | N | 2.4394' | N | |
| L84 | 1.44' | N | 1.7929' | N | |
| L85 | 18.40' | N | 1.7929' | N | |
| L86 | 18.40' | N | 8.7594' | E | |
| L87 | 22.40' | S | 1.7929' | E | |
| L88 | 10.04' | S | 2.4394' | E | |
| L89 | 70.80' | S | 6.4246' | N | |
| L90 | 35.50' | S | 6.4246' | N | |
| L91 | 24.00' | N | 8.7594' | N | |
| L92 | 22.40' | N | 8.7594' | N | |
| L93 | 24.00' | N | 8.7594' | N | |
| L94 | 24.00' | N | 8.7594' | N | |
| L95 | 18.40' | N | 8.7594' | N | |
| L96 | 18.40' | N | 8.7594' | N | |
| L97 | 28.28' | S | 1.7929' | E | |
| L98 | 28.28' | S | 4.2394' | E | |
| L99 | 4.80' | S | 1.7929' | E | |
| L100 | 11.70' | N | 8.7594' | E | |

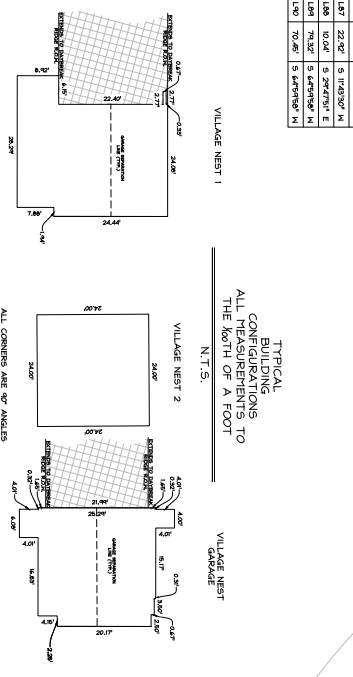

IF ANY UNITS ARE SITUATED IN A NOTE REGISTERED BY AN APPLICANT TO BE AN ADJACENT PARCEL, THE APPLICANT IS RESPONSIBLE TO PROVIDE THE NECESSARY RECORDS TO SUPPORT THE APPLICANT'S CLAIMS. THE APPLICANT SHALL BE RESPONSIBLE FOR PROVIDING THE NECESSARY RECORDS TO SUPPORT THE APPLICANT'S CLAIMS. THE APPLICANT SHALL BE RESPONSIBLE FOR PROVIDING THE NECESSARY RECORDS TO SUPPORT THE APPLICANT'S CLAIMS. THE APPLICANT SHALL BE RESPONSIBLE FOR PROVIDING THE NECESSARY RECORDS TO SUPPORT THE APPLICANT'S CLAIMS.

Sheet 2 of 4

NVS NORTH VERMONT SURVEYORS

REGISTERED PROFESSIONAL SURVEYORS
 5121 SHREVEPORT DRIVE, SUITE 100
 SOUTH VERMONT, VERMONT 05487-1101
 PHONE: (802) 249-4800
 FAX: (802) 249-4801
 WWW.NVSURVEYORS.COM

PROJECT: VILLAGE NESTS AT POWDER MOUNTAIN
 SHEET NO. 2 OF 4
 DATE: _____
 DRAWN BY: _____
 CHECKED BY: _____
 SCALE: _____

VERMONT COUNTY RECORDER

VILLAGE NESTS AT POWDER MOUNTAIN
 A CONDOMINIUM PLAT

LOCATED IN THE NORTHEAST QUARTER OF SECTION 9,
 TOWNSHIP 7 NORTH, RANGE 2 EAST,
 SALT LAKE BASE AND MERIDIAN
 JANUARY 2016

VILLAGE NEST 1 (VNI)
 UNITS 1, 2, 3, 4, 5, 6, 7, & 8

N.T.S.
 JANUARY 2014

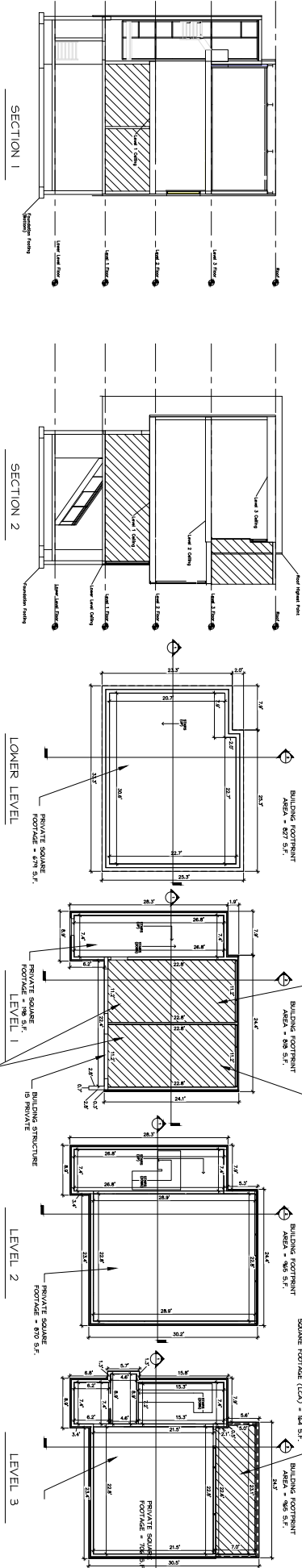

NOTE: SEE BUILDING UNIT ELEVATION TABLE FOR ELEVATION OF CEILING, FLOORS, FOUNDATION, AND ROOF ELEVATIONS.

BUILDING UNIT ELEVATION TABLE

| Building # | Foundation | Lower Level | Level 1 | Level 2 | Level 3 | Roof Highest |
|------------|------------|-------------|---------|---------|---------|--------------|
| 1 | 6893.00 | 6893.00 | 6893.00 | 6893.00 | 6893.00 | 6893.00 |
| 2 | 6893.00 | 6893.00 | 6893.00 | 6893.00 | 6893.00 | 6893.00 |
| 3 | 6893.00 | 6893.00 | 6893.00 | 6893.00 | 6893.00 | 6893.00 |
| 4 | 6893.00 | 6893.00 | 6893.00 | 6893.00 | 6893.00 | 6893.00 |
| 5 | 6893.00 | 6893.00 | 6893.00 | 6893.00 | 6893.00 | 6893.00 |
| 6 | 6893.00 | 6893.00 | 6893.00 | 6893.00 | 6893.00 | 6893.00 |
| 7 | 6893.00 | 6893.00 | 6893.00 | 6893.00 | 6893.00 | 6893.00 |
| 8 | 6893.00 | 6893.00 | 6893.00 | 6893.00 | 6893.00 | 6893.00 |

AREA DESIGNATION TABLE

| Private Square Footage | Area |
|------------------------|----------|
| 674 S.F. | 474 S.F. |
| 286 S.F. | |

LEGEND

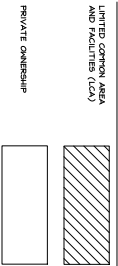

SHHG PHASE 1, LLC,
 3632 N. WOLF CREEK DR.,
 EDEN, UT, 84310

MADE VERTICALLINE
 N.V.S.
 REGISTERED PROFESSIONAL ARCHITECT
 325 WEST 10TH AVENUE
 DENVER, CO 80202

RECORDED &

STATE OF UTAH, COUNTY OF MEBER,
 RECORDED AND FILED AT THE

REQUEST ON _____
 DATE _____ TIME _____
 BOOK _____ PAGE _____
 FILE # _____

MEMBER COUNTY RECORDER

Exhibit A-Proposed Subdivision

VILLAGE NESTS AT POWDER MOUNTAIN A CONDOMINIUM PLAT

LOCATED IN THE NORTHEAST QUARTER OF SECTION 8,
 TOWNSHIP 7 NORTH, RANGE 2 EAST,
 SALT LAKE COUNTY, UTAH
 JANUARY 2008

VILLAGE NEST 2 (VNG2)
 UNITS 9, 10, 11, 12, 13, 14, 15, 16, 17, 18, 19, & 20

N.T.S.

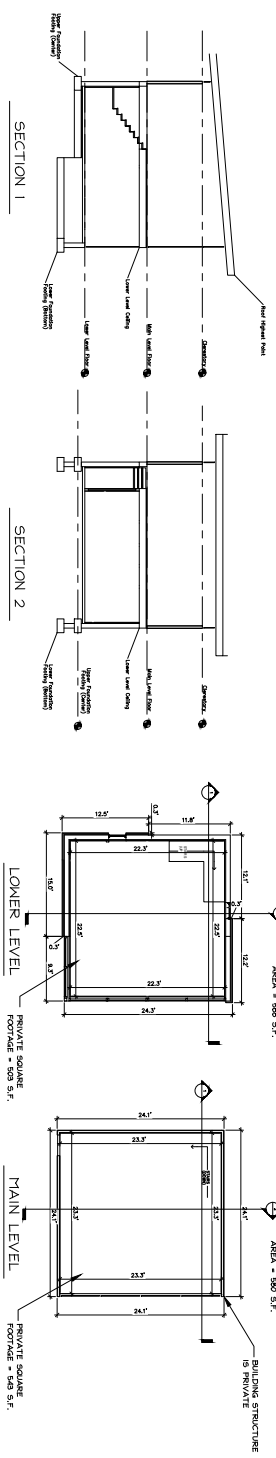

NOTE: SEE BUILDING UNIT ELEVATION TABLE FOR ELEVATION OF CEILING, FLOORS, FOUNDATION, AND ROOF ELEVATIONS.

BUILDING UNIT ELEVATION TABLE

| Building | Lower Level | Upper Level | Foundation | Roof | Height |
|----------|-------------|-------------|------------|---------|---------|
| 1 | 8250.00 | 8250.00 | 8250.00 | 8250.00 | 8250.00 |
| 2 | 8250.00 | 8250.00 | 8250.00 | 8250.00 | 8250.00 |
| 3 | 8250.00 | 8250.00 | 8250.00 | 8250.00 | 8250.00 |
| 4 | 8250.00 | 8250.00 | 8250.00 | 8250.00 | 8250.00 |
| 5 | 8250.00 | 8250.00 | 8250.00 | 8250.00 | 8250.00 |
| 6 | 8250.00 | 8250.00 | 8250.00 | 8250.00 | 8250.00 |
| 7 | 8250.00 | 8250.00 | 8250.00 | 8250.00 | 8250.00 |
| 8 | 8250.00 | 8250.00 | 8250.00 | 8250.00 | 8250.00 |
| 9 | 8250.00 | 8250.00 | 8250.00 | 8250.00 | 8250.00 |
| 10 | 8250.00 | 8250.00 | 8250.00 | 8250.00 | 8250.00 |
| 11 | 8250.00 | 8250.00 | 8250.00 | 8250.00 | 8250.00 |
| 12 | 8250.00 | 8250.00 | 8250.00 | 8250.00 | 8250.00 |
| 13 | 8250.00 | 8250.00 | 8250.00 | 8250.00 | 8250.00 |
| 14 | 8250.00 | 8250.00 | 8250.00 | 8250.00 | 8250.00 |
| 15 | 8250.00 | 8250.00 | 8250.00 | 8250.00 | 8250.00 |
| 16 | 8250.00 | 8250.00 | 8250.00 | 8250.00 | 8250.00 |
| 17 | 8250.00 | 8250.00 | 8250.00 | 8250.00 | 8250.00 |
| 18 | 8250.00 | 8250.00 | 8250.00 | 8250.00 | 8250.00 |
| 19 | 8250.00 | 8250.00 | 8250.00 | 8250.00 | 8250.00 |
| 20 | 8250.00 | 8250.00 | 8250.00 | 8250.00 | 8250.00 |

AREA DESIGNATION TABLE

| Private Square Footage | Other S.F. |
|------------------------|------------|
| 9,408 S.F. | 0 S.F. |

VILLAGE NEST GARAGES (VNG)

N.T.S.

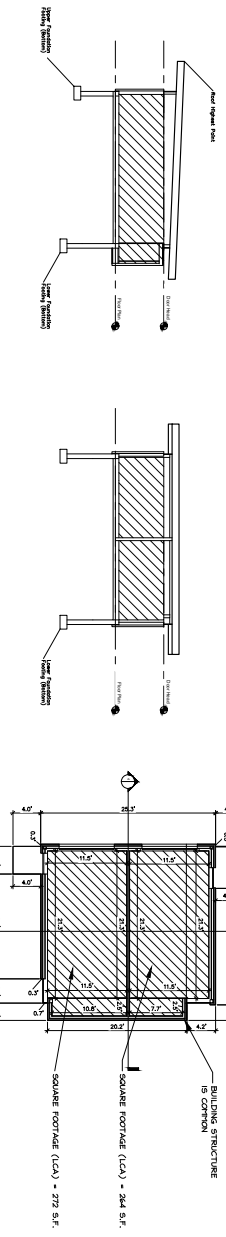

NOTE: SEE BUILDING UNIT ELEVATION TABLE FOR ELEVATION OF CEILING, FLOORS, FOUNDATION, AND ROOF ELEVATIONS.

BUILDING ELEVATION TABLE

| Building | Lower Foundation | Upper Foundation | Private Square Footage | Other Square Footage |
|----------|------------------|------------------|------------------------|----------------------|
| 1 | 8250.00 | 8250.00 | 9,408 S.F. | 0 S.F. |

AREA DESIGNATION TABLE

| Private Square Footage | Other Square Footage |
|------------------------|----------------------|
| 9,408 S.F. | 0 S.F. |

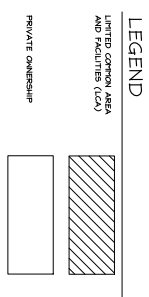

Sheet 4 of 4

NVS
 NOTICE OF VERIFICATION
 STATE OF UTAH, COUNTY OF WEBER,
 RECORDED AND FILED AT THE
 REGISTER OF DEEDS OFFICE
 REQUEST OF _____
 ENTRY NO. _____
 DATE _____ TIME _____
 BOOK _____ PAGE _____
 FILE # _____
 MEMBER COUNTY RECORDER

Exhibit B-Proposed Summit Eden Phase 1D, Amendment 1

SUMMIT EDEN PHASE 1D - AMENDMENT 1

LOCATED IN THE NORTHEAST 1/4 OF SECTION 8,
 TOWNSHIP 7 NORTH, RANGE 3 EAST, SALT LAKE BASE AND MERIDIAN
 JANUARY 2016

- ### LEGEND
- BOUNDARY LINE
 - LOT LINE
 - SECTION LINE
 - QUARTER SECTION LINE
 - COUNTY LINE
 - ADJOINER DEED LINES
 - NO ACCESS LINE
 - AREA TIE LINES
 - CALCULATED SECTION CORNER AS NOTED
 - SECTION CORNER AS NOTED
 - STREET MOUNTAIN
 - SET 5/8" X 7" REBAR WITH PLASTIC CAP STAMPED "NO TIE END"
 - EASMENT AS NOTED
 - EASEMENT AS NOTED
 - EASEMENT AS NOTED

SHHG PHASE 1, LLC,
 3633 N. WOLF CREEK DR.,
 EDEN, UT, 84310

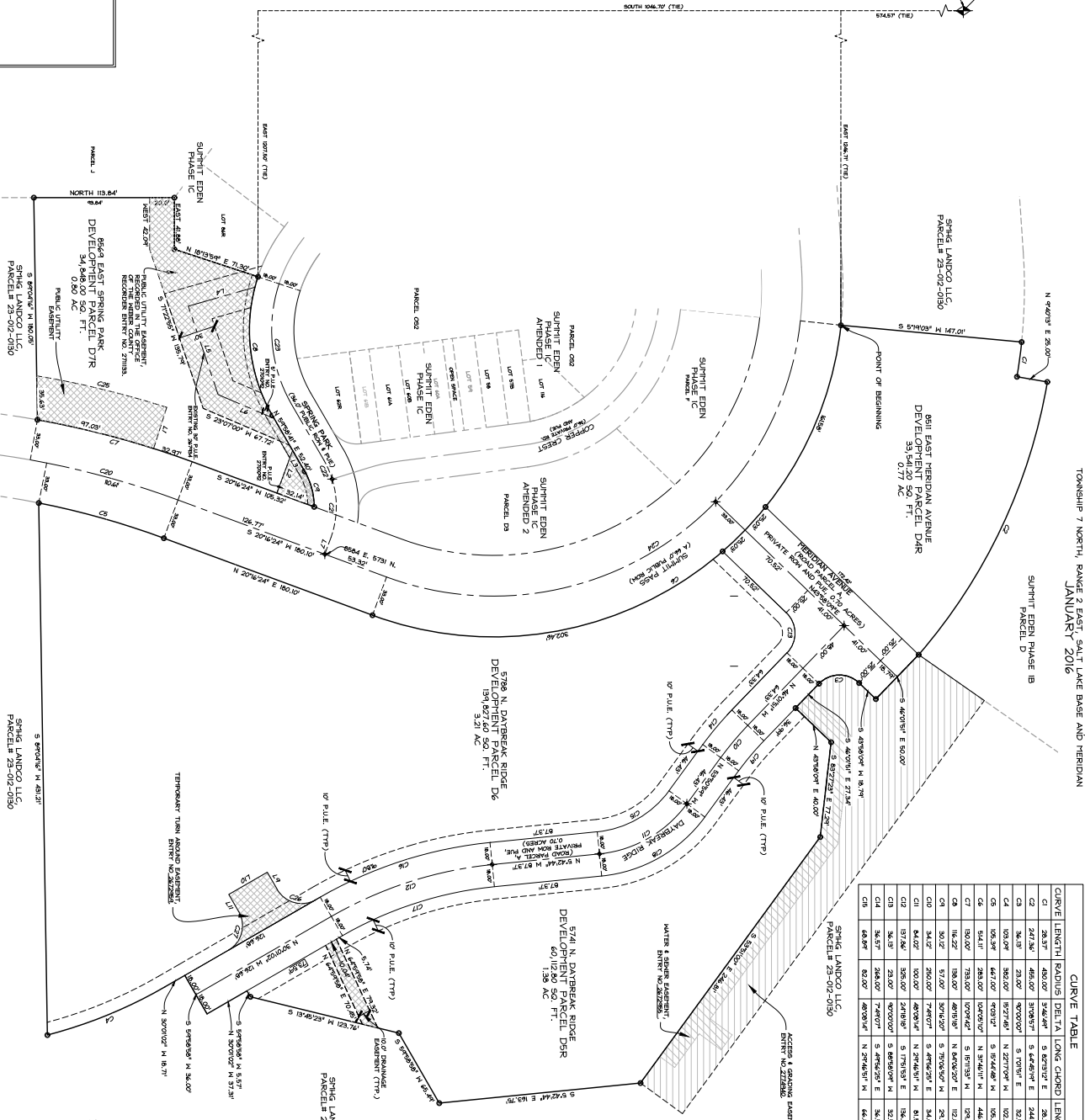

CURVE TABLE

| CURVE | LENGTH | RADIUS | DELTA | LONG CHORD | LENGTH |
|-------|--------|--------|------------|------------|--------|
| C1 | 283.37 | 405.00 | 5.87932° E | 283.37 | |
| C2 | 34.13 | 23.00 | 5.87932° E | 24.433 | |
| C3 | 34.13 | 23.00 | 5.87932° E | 24.433 | |
| C4 | 34.13 | 23.00 | 5.87932° E | 24.433 | |
| C5 | 34.13 | 23.00 | 5.87932° E | 24.433 | |
| C6 | 34.13 | 23.00 | 5.87932° E | 24.433 | |
| C7 | 34.13 | 23.00 | 5.87932° E | 24.433 | |
| C8 | 34.13 | 23.00 | 5.87932° E | 24.433 | |
| C9 | 34.13 | 23.00 | 5.87932° E | 24.433 | |
| C10 | 34.13 | 23.00 | 5.87932° E | 24.433 | |
| C11 | 34.13 | 23.00 | 5.87932° E | 24.433 | |
| C12 | 34.13 | 23.00 | 5.87932° E | 24.433 | |
| C13 | 34.13 | 23.00 | 5.87932° E | 24.433 | |
| C14 | 34.13 | 23.00 | 5.87932° E | 24.433 | |
| C15 | 34.13 | 23.00 | 5.87932° E | 24.433 | |

CURVE TABLE

| CURVE | LENGTH | RADIUS | DELTA | LONG CHORD | LENGTH |
|-------|--------|--------|------------|------------|--------|
| C16 | 166.67 | 340.00 | 2.90916° E | 166.67 | |
| C17 | 100.25 | 200.00 | 2.90916° E | 100.25 | |
| C18 | 94.14 | 188.00 | 2.90916° E | 94.14 | |
| C19 | 31.42 | 22.00 | 2.90916° E | 22.00 | |
| C20 | 31.42 | 22.00 | 2.90916° E | 22.00 | |
| C21 | 31.42 | 22.00 | 2.90916° E | 22.00 | |
| C22 | 31.42 | 22.00 | 2.90916° E | 22.00 | |
| C23 | 31.42 | 22.00 | 2.90916° E | 22.00 | |
| C24 | 31.42 | 22.00 | 2.90916° E | 22.00 | |
| C25 | 104.49 | 164.00 | 2.90916° E | 104.49 | |
| C26 | 34.13 | 23.00 | 5.87932° E | 24.433 | |
| C27 | 34.13 | 23.00 | 5.87932° E | 24.433 | |

LINE TABLE

| LINE | LENGTH | DIRECTION |
|------|--------|---------------|
| L1 | 34.00 | S 72°00'00" E |
| L2 | 34.00 | S 72°00'00" E |
| L3 | 34.00 | S 72°00'00" E |
| L4 | 34.00 | S 72°00'00" E |
| L5 | 34.00 | S 72°00'00" E |
| L6 | 34.00 | S 72°00'00" E |
| L7 | 34.00 | S 72°00'00" E |
| L8 | 34.00 | S 72°00'00" E |
| L9 | 34.00 | S 72°00'00" E |
| L10 | 34.00 | S 72°00'00" E |
| L11 | 34.00 | S 72°00'00" E |

Sheet 2 of 2

REGISTERED & RECORDED IN THE OFFICE OF THE COUNTY CLERK, SALT LAKE COUNTY, UTAH, ON JANUARY 15, 2016.

MAPLE VENTURE FUND, LLC

STATE OF UTAH, COUNTY OF HERRIS,
 RECORDED AND FILED AT THE
 REQUEST OF _____
 ENTRY NO. _____
 DATE _____
 BOOK _____
 PAGE _____
 FILE # _____

HERRIS COUNTY RECORDER

WEBER COUNTY
SUBDIVISION IMPROVEMENT
AGREEMENT

1. **Parties:** The parties to this Subdivision Improvement Agreement ("the Agreement") are SMHG Phase 1, LLC ("the Developer") and Weber County Corp. ("the County").
2. **Effective Date:** The Effective Date of this Agreement will be the date that final subdivision plat approval is granted by the County Commission ("the Commission").

RECITALS

WHEREAS, the Developer seeks permission to subdivide property within the unincorporated area of Weber County, to be known as Village Nests at Powder Mountain, A Condominium Plat (the "Subdivision"), which property is more particularly described on Exhibit A attached hereto and incorporated herein by this reference (the "Property"); and

WHEREAS, in 2013, the County and the Developer entered into a Cash in Lieu of Bond/Loan Agreement (number C2013-250), under which the Developer deposited estimated adequate funds with the County for a multi-phased development; and

WHEREAS, the County seeks to protect the health, safety and general welfare of the residents by requiring the completion of various improvements in the Subdivision and thereby to limit the harmful effects of substandard subdivisions, including premature subdivision which leaves property undeveloped and unproductive; and

WHEREAS, the purpose of this Agreement is to protect the County from the cost of completing subdivision improvements itself and is not executed for the benefit of material, men, laborers, or others providing work, services or material to the Subdivision or for the benefit of lot or home buyers in the Subdivision; and

WHEREAS, the mutual promises, covenants, and obligations contained in this Agreement are authorized by state law and the County's Code of Ordinances Part II Land Use Code Title 108 et seq;

THEREFORE, the Parties hereby agree as follows:

DEVELOPER'S OBLIGATIONS

3. **Improvements:** The Developer will construct and install, at his own expense, those on-site and off-site subdivision improvements listed on Exhibit B attached hereto and incorporated herein by this reference ("the Improvements"). The Developer's obligation to complete the Improvements will arise upon final plat approval by the County, will be independent of any obligations of the County contained herein and will not be conditioned on the commencement of construction in the development or sale of any lots or improvements within the development.

Exhibit C

4. **Security:** To secure the performance of his obligations hereunder, the Developer has entered into a “Cash in Lieu of Bond/Loan Agreement C2013-250 “ with the County and deposited estimated funds with the County for a multi-phased development. As part of the said agreement, \$498,085.36 will be now be allocated to Village Nests at Powder Mountain, A Condominium Plat.
5. **Standards:** The Developer will construct the Improvements according to the Public Works Standards and Technical Specifications as incorporated herein by this reference.
6. **Warranty:** The Developer warrants that the Improvements, each and every one of them, will be free from defects for a period of one year from the date that the County accepts the improvement when completed by the Developer.
7. **Completion Periods:** The Developer will commence work on the Improvements within one year from the Effective Date of this Agreement (the "Commencement Period") and the Improvements, each and every one of them, will be completed within two years from the Effective Date of this Agreement (the "Completion Period").
8. **Compliance with Law:** The Developer will comply with all relevant laws, ordinances, and regulations in effect at the time of final subdivision plat approval when fulfilling his obligations under this Agreement. When necessary to protect public health, the Developer will be subject to laws, ordinances and regulations that become effective after final plat approval.
9. **Dedication:** The developer will dedicate to the County or other applicable agency as designated by the County the Improvements listed on Exhibit B attached hereto and incorporated herein by this reference pursuant to the procedure described in Paragraph 13 below.

COUNTY'S OBLIGATIONS

10. **Plat Approval:** The County will grant final subdivision plat approval to the Subdivision under the terms and conditions previously agreed to by the Parties if those terms and conditions are consistent with all relevant state laws and local ordinances in effect at the time of final plat approval.
11. **Inspection and Certification:** The County will inspect the Improvements as they are being constructed and, if acceptable to the County Engineer, certify such improvement as being in compliance with the standards and specifications of the County. Such inspection and certification, if appropriate, will occur within 7 days of notice by the Developer that he desires to have the County inspect an improvement. Before obtaining certification of any such improvement, the Developer will present to the County valid lien waivers from all persons providing materials or performing work on the improvement for which certification is sought. Certification by the County Engineer does not constitute a waiver by the County of the right to draw funds under the Escrow on account of defects in or failure of any improvement that is detected or which occurs following such certification.
12. **Notice of Defect:** The County will provide timely notice to the Developer whenever inspection reveals that an improvement does not conform to the standards and specifications shown on the approved subdivision improvement drawings on file in the Weber County Engineering and Surveyor's Office or is otherwise defective. The Developer will have 30 days from the issuance of such notice to cure or substantially cure the defect. The County may not declare a default under this Agreement during the 30 day cure period on account

Exhibit C

of any such defect unless it is clear that the Developer does not intend to cure the defect. The Developer will have no right to cure defects in or failure of any improvement found to exist or occurring after the County accepts dedication of the improvement(s).

13. **Acceptance of Dedication:** The County or other applicable agency will accept the dedication of any validly certified improvement within 30 days of the Developer's offer to dedicate the improvement. The County's or agency's acceptance of dedication is expressly conditioned on the presentation by the Developer of a policy of title insurance, where appropriate, for the benefit of the County showing that the Developer owns the improvement in fee simple and that there are no liens, encumbrances, or other restrictions on the improvement unacceptable to the County in its reasonable judgment. Acceptance of the dedication of any improvement does not constitute a waiver by the County of the right to draw funds under the Escrow on account of any defect in or failure of the improvement that is detected or which occurs after the acceptance of the dedication. The Improvements must be offered to the County in no more than one dedication per month.
14. **Reduction of Security:** After the acceptance of any improvement, the amount which the County is entitled to draw on the Escrow may be reduced by an amount equal to 90 percent of the estimated cost of the improvement as shown on Exhibit B. At the request of the Developer, the County will execute a certificate of release verifying the acceptance of the improvement and waiving its right to draw on the Escrow to the extent of such amount. A Developer in default under this Agreement will have no right to such a certificate. Upon the acceptance of all of the Improvements, the balance that may be drawn under Escrow will be available to the County for 90 days after expiration of the Warranty Period.
15. **Use of Proceeds:** The County will use funds drawn under the Escrow only for the purposes of completing the Improvements or correcting defects in or failures of the Improvements.

OTHER PROVISION

16. **Events of Default:** The following conditions, occurrences or actions will constitute a default by the Developer during the Construction Period:
 - a. Developer's failure to commence construction of the Improvements within one year of final subdivision plat approval;
 - b. Developer's failure to complete construction of the Improvements within two years of final subdivision plat approval;
 - c. Developer's failure to cure the defective construction of any improvement within the applicable cure period;
 - d. Developer's insolvency, the appointment of a receiver for the Developer or the filing of a voluntary or involuntary petition in bankruptcy respecting the Developer;
 - e. Foreclosure of any lien against the Property or a portion of the Property or assignment or conveyance of the Property in lieu of foreclosure.

The County may not declare a default until written notice has been given to the Developer.

Exhibit C

17. **Measure of Damages:** The measure of damages for breach of this Agreement will be the reasonable cost of completing the Improvements. For improvements upon which construction has not begun, the estimated cost of the Improvements as shown on Exhibit B will be prima facie evidence of the minimum cost of completion; however, neither that amount nor the amount of the Escrow establishes the maximum amount of the developer's liability. The County will be entitled to complete all unfinished improvements at the time of default regardless of the extent to which development has taken place in the Subdivision or whether development ever commenced.
18. **County's Rights Upon Default:** When any event of default occurs, the County may draw on the Escrow to the extent of the face amount of the credit less 90 percent of the estimated cost (as shown on Exhibit B) of all improvements theretofore accepted by the County. The County will have the right to complete improvements itself or contract with a third party for completion, and the Developer hereby grants to the County, its successors, assigns, agents, contractors, and employees, a nonexclusive right and easement to enter the Property for the purposes of constructing, maintaining, and repairing such improvements. Alternatively, the County may assign the proceeds of the Escrow to a subsequent developer (or a lender) who has acquired the Subdivision by purchase, foreclosure or otherwise who will then have the same rights of completion as the County if and only if the subsequent developer (or lender) agrees in writing to complete the unfinished improvements. In addition, the County also may suspend final plat approval during which time the Developer will have no right to sell, transfer, or otherwise convey lots or homes within the Subdivision without the express written approval of the County or until the Improvements are completed and approved by the County. These remedies are cumulative in nature except that during the Warranty Period, the County's only remedy will be to draw funds under the Escrow.
19. **Indemnification:** The Developer hereby expressly agrees to indemnify and hold the County harmless from and against all claims, costs and liability of every kind and nature, for injury or damage received or sustained by any person or entity in connection with, or on account of the performance of work at the development site and elsewhere pursuant to this Agreement. The Developer further agrees to aid and defend the County in the event that the County is named as a defendant in an action concerning the performance of work pursuant to this Agreement except where such suit is brought by the Developer. The Developer is not an agent or employee of the County.
20. **No Waiver:** No waiver of any provision of this Agreement will be deemed or constitute a waiver of any other provision, nor will it be deemed or constitute a continuing waiver unless expressly provided for by a written amendment to this Agreement signed by both County and Developer; nor will the waiver of any default under this Agreement be deemed a waiver of any subsequent default or defaults of the same type. The County's failure to exercise any right under this Agreement will not constitute the approval of any wrongful act by the Developer or the acceptance of any improvement.
21. **Amendment or Modification:** The parties to this Agreement may amend or modify this Agreement only by written instrument executed by the County and by the Developer or his authorized officer. Such amendment or modification will be properly notarized before it may be effective.

Exhibit C

22. **Attorney's Fees:** Should either party be required to resort to litigation, arbitration, or mediation to enforce the terms of this Agreement, the prevailing party, plaintiff or defendant, will be entitled to costs, including reasonable attorney's fees and expert witness fees, from the opposing party. If the court, arbitrator, or mediator awards relief to both parties, each will bear its own costs in their entirety.
23. **Vested Rights:** The County does not warrant by this Agreement that the Developer is entitled to any other approval(s) required by the County, if any, before the Developer is entitled to commence development of the Subdivision or to transfer ownership of property in the Subdivision.
24. **Third Party Rights:** No person or entity who or which is not a party to this Agreement will have any right of action under this Agreement, except that if the County does not exercise its rights within 60 days following knowledge of an event of default, a purchaser of a lot or home in the Subdivision may bring an action in mandamus to compel the County to exercise its rights.
25. **Scope:** This Agreement constitutes the entire agreement between the parties and no statement(s), promise(s) or inducement(s) that is/are not contained in this Agreement will be binding on the parties.
26. **Time:** For the purpose of computing the Commencement, Abandonment, and Completion Periods, and time periods for County action, such times in which civil disaster, acts of God, or extreme weather conditions occur or exist will not be included if such times prevent the Developer or County from performing his/its obligations under the Agreement.
27. **Severability:** If any part, term or provision of this Agreement is held by the courts to be illegal or otherwise unenforceable, such illegality or unenforceability will not affect the validity of any other part, term, or provision and the rights of the parties will be construed as if the part, term, or provision was never part of the Agreement.
28. **Benefits:** The benefits of this Agreement to the Developer are personal and may not be assigned without the express written approval of the County. Such approval may not be unreasonable withheld, but any unapproved assignment is void. Notwithstanding the foregoing, the burdens of this Agreement are personal obligations of the Developer and also will be binding on the heirs, successors, and assigns of the Developer. There is no prohibition on the right of the County to assign its rights under this Agreement. The County will release the original developer's Escrow if it accepts new security from any developer or lender who obtains the Property. However, no act of the County will constitute a release of the original developer from this liability under this Agreement.
29. **Notice:** Any notice required or permitted by this Agreement will be deemed effective when personally delivered in writing or three (3) days after notice is deposited with the U.S Postal Service, postage prepaid, certified, and return receipt requested, and addressed as follows:

if to Developer (Attn:)
(Address)

SMHG Phase 1, LLC
3632 N. Wolf Creek Drive
Eden, UT 84310

Exhibit C

if to County:

Attn: County Engineer
The Weber Center
2380 Washington Blvd. Suite 240
Ogden, UT 84401

- 30. **Recordation:** Either Developer or County may record a copy of this Agreement in the Clerk’s Office and the Recorder’s Office of Weber County, Utah.
- 31. **Immunity:** Nothing contained in this Agreement constitutes a waiver of the County’s sovereign immunity under any applicable state law.
- 32. **Personal Jurisdiction and Venue:** Personal jurisdiction and venue for any civil action commenced by either party to this Agreement whether arising out of or relating to the Agreement will be deemed to be proper only if such action is commenced in District Court for Weber County. The Developer expressly waives his right to bring such action in or to remove such action to any other court whether state or federal.
- 33. **Amendment of Cash in Lieu of Bond/Loan Agreement number C2013-250.** The parties agree that this Agreement amends Cash in Lieu of Bond/Loan Agreement number C2013-250. To the extent that any provisions of that agreement conflict with provisions of this Agreement, the provisions of this Agreement prevail and supersede the conflicting provisions of that agreement. However, the provisions of that agreement remain in effect, to the extent that they do not conflict with the provisions of this Agreement, unless they have been otherwise terminated or superseded.

Dated this _____ day of _____, 20__.

Developer

State of Utah)
 ss
County of Weber)

On the _____ day of _____ A.D. 20__ personally appeared before me duly sworn, did say that he/she is the _____ of _____, the corporation which executed the foregoing instrument, and that said instrument was signed in behalf of said corporation by authority of a Resolution of its Board of Directors that the said corporation executed the same.

Notary Public
Residing at:

Exhibit C

APPROVED AS TO FORM:

Weber County Attorney

Chairperson, Weber County Commission

Date

ATTEST:

Weber County Clerk

EXHIBIT A: PROPERTY DESCRIPTION TO BE SUBDIVIDED

All of Village Nests a Powder Mountain Subdivision, a condominium plat as recorded with the Weber County Recorder's Office.

Exhibit C

EXHIBIT B: REQUIRED ON & OFF SITE SUBDIVISION IMPROVEMENTS

See attached “Exhibit B”

| Exhibit B Summit at Powder Mountain Village Nests Escrow Estimate | | | | |
|---|----------|-------------|--------------|---------------------|
| Description | Quantity | | Unit Price | Total Price |
| General | | | | |
| Mobilization | 1 | Lump Sum | \$35,311.86 | \$35,311.86 |
| Construction Surveying | 1 | Lump Sum | \$3,500.00 | \$3,500.00 |
| Elevated Walkways | 1 | Lump Sum | \$45,000.00 | \$45,000.00 |
| Roadway Construction and Earthwork | | | | |
| Granular Borrow Import and Placement (Plan Quantity) | 1,050 | Cubic Yard | \$19.50 | \$20,475.00 |
| Roadway Excavation | 4,040 | Cubic Yard | \$6.00 | \$24,240.00 |
| Embankment Fill | 5,630 | Cubic Yard | \$5.00 | \$28,150.00 |
| Aggregate Base Course Import and Placement (Plan | 85 | Cubic Yard | \$35.00 | \$2,975.00 |
| Rock Excavation and Removal | 500 | Cubic Yard | \$16.00 | \$8,000.00 |
| Rockery Surface Area | 3,524 | Square Feet | \$10.00 | \$35,240.00 |
| Concrete Walks/Driveways | 4,602 | Square Feet | \$4.00 | \$18,408.00 |
| Culinary Water Distribution System | | | | |
| 8" DIPS DR-13.5 HDPE Pipe | 472 | Linear Feet | \$35.00 | \$16,520.00 |
| 8" Bends | 8 | Each | \$900.00 | \$7,200.00 |
| ¾" Water Lateral with Marker | 20 | Each | \$1,500.00 | \$30,000.00 |
| Sanitary Sewer Collection System | | | | |
| 8" SDR-35 PVC Pipe | 507 | Linear Feet | \$49.00 | \$24,843.00 |
| 1.5" IPS DR-11 HDPE Pressure Sewer Pipe | 353 | Linear Feet | \$11.00 | \$3,883.00 |
| 4' Concrete Manhole | 3 | Each | \$2,500.00 | \$7,500.00 |
| 4' Concrete Manhole | 2 | Each | \$2,900.00 | \$5,800.00 |
| Sewer Lateral | 14 | Each | \$1,600.00 | \$22,400.00 |
| Sewer Lift Station w/Generator | 1 | Lump Sum | \$124,000.00 | \$124,000.00 |
| Connection to Existing Sewer Manhole | 2 | Lump Sum | \$600.00 | \$1,200.00 |
| Electrical Service- Lift Station | | | | |
| Electrical Conduit | 360 | Linear Feet | \$15.00 | \$5,400.00 |
| Electrical Conductor | 360 | Linear Feet | \$20.00 | \$7,200.00 |
| Transformer Pad | 1 | Each | \$2,500.00 | \$2,500.00 |
| Transformer Equipment | 1 | Each | \$6,500.00 | \$6,500.00 |
| Erosion Control | | | | |
| Silt Fence | 885 | Linear Feet | \$2.70 | \$2,389.50 |
| SWPPP Management and Maintenance | 1 | Lump Sum | \$3,000.00 | \$3,000.00 |
| Revegetation / Landscaping | 43,000 | Square Feet | \$0.15 | \$6,450.00 |
| SUBTOTAL | | | | \$498,085.36 |

Exhibit C

EXHIBIT C: FINANCIAL GUARANTEE

See attached “Exhibit C”



Weber County

Exhibit C

Escrow Certificate

To Weber County, Utah:

The undersigned Escrow Agent does hereby certify that it has in its possession and custody, cash in the sum of \$498,085.36 which said sum said Escrow Agent is holding in escrow to guarantee the installation and completion, according to Ordinance, of all on and or off-site improvements, as specified in Exhibit "B" on the following described tracts of land in Weber County, Utah to wit:

LEGAL DESCRIPTION

All of Village Nests a Powder Mountain Subdivision, a condominium plat as recorded with the Weber County Recorder's Office.

In the event the funds so provided herein do not pay for and complete in full all of the specified improvements set forth in Exhibit "B" and as contemplated herein, then and in that event, Subdivider/developer agrees to forthwith pay to Weber County all additional amounts necessary to so complete such improvements.

Said Escrow Agent hereby covenants and agrees that it will not release said funds to any person, firm or corporation (other than as is hereinafter provided) without the express written consent and direction from said Weber County, Utah, and that if said improvements are not satisfactorily installed and completed according to Ordinance within one month short of two years from the date hereof, that the said Escrow Agent will upon demand deliver said funds to said Weber County, Utah for the sole purpose of making and/or completing all of said improvements, with said County to return to the said Escrow Agent any and all funds which may prove to be in excess of the actual cost to the County to make and/or complete said improvements.

It is understood that the County may, at its sole option, extend said period of two years for such completion of such improvements upon request of the Escrow Agent or the Subdivider/Developer, if the County Commission determines that such extension is proper.

It is further understood and agreed that all matters concerning this agreement shall be subject to the pertinent provisions of the ordinances of Weber County, Utah.

Exhibit D-Draft Minutes from OVPC

Minutes of the Ogden Valley Planning Commission Regular meeting January 05, 2016, in the Weber County Commission Chambers, commencing at 5:00 p.m.

Present: Laura Warburton, Chair; Jami Taylor, John Howell, Greg Graves, Stephen Waldrip, Kevin Parson

Absent/Excused: Will Haymond,

Staff Present: Sean Wilkinson, Planning Director; Scott Mendoza, Asst Planning Director; Ronda Kippen, Planner; Ben Hatfield, Planner; Courtlan Erickson, Legal Counsel; Kary Serrano, Secretary

Pledge of Allegiance

Chair Warburton said that Commissioner Haymond is excused and Commissioner Waldrip would be arriving late. She asked the Planning Commissioners if there were any ex parte to declare, there were none.

1. Consent Agenda:

- 1.1. UVS92004DP:** Consideration and action for a final plat approval of Summit Eden Village Nests Condominium Subdivision located at the Powder Mountain Ski Resort (Daybreak Ridge) in the Ogden Valley Destination and Recreation Resort-1 (DRR-1) Zone (Summit Mountain Holding Group, LLC, Applicant)

Commissioner Parson moved to approve consent agenda UVS92004DP as it stands. Chair Warburton seconded. A vote was taken with Commissioners Taylor, Howell Graves, Parson and Chair Warburton voting aye. Motion Carried (5-0)

Chair Hollist asked Sean if it was possible for them to specify two parking spaces and they can be either side by side or tandem depending upon the topography. Sean Wilkinson replied the only problem that they would have is the size of the side by side where there is an actual standard that says nine feet wide.

Commissioner Howell asked about snow removal. Sean Wilkinson said some of these lots may not actually have driveways; they have zero front yard setbacks.

Eric Langvardt asked if they could they have the flexibility to do side by side or tandem depending on lot width. Side by side parking is allowed. If it is less than 20 ft. tandem parking is required.

Rob Scott said his concern is about the limited visitor parking. Russ Watts described the plan for parking at mid-mountain and shuttling to the homes.

Commissioner Howell asked for the distance from the shuttle area to the village area? Russ Watts replied that it is about 2.25 miles from mid-mountain. This issue will be addressed as part of their DRR-1 submittal.

Steve Clarke said he wanted clarification on the concept for the commercial area, the residential area, and the zero lot setbacks from the road. Chair Hollist replied that along the Summit Pass road, they have moved from the large ranchettes and the housing gets closer together with more density as they move towards the village. Sean Wilkinson replied as part of the PRUD there is no commercial in Phase 1C; this is entirely residential except for the conference center.

Commissioner Hollist asked Summit to briefly remind the Planning Commission of what is coming next. Eric Langvardt mentioned the DRR-1 rezone and future commercial areas inside and outside of the PRUD boundary.

Commissioner Parson asked if there was any overflow parking. Eric Langvardt replied there will be places for parking but for right now there is no commercial proposed. As part of the DRR-1 rezone, Summit is proposing.

MOTION: Commissioner Miller moved to recommend to the County Commission approval of UVS9241C including allowing tandem or side by side parking with the requirement that they need more than 20 feet to do the side by side parking. Commissioner Warburton seconded.

VOTE: A vote was taken with all members voting aye and Chair Hollist declared that the motion carried (5-0).

4. UVS9241D: Consideration and action on final approval of Summit at Powder Mountain Phase 1D located at Powder Mountain Ski Resort within the Forest Valley-3 Zone (FV-3), Forest-40 Zone (F-40) (Summit Mountain Holding Group LLC, Applicant)

5. UVS924DP: Consideration and action on final approval of Summit at Powder Mountain Phase 1D, Development Parcel D located at Powder Mountain Ski Resort (Daybreak Ridge) within the Forest Valley-3 Zone (FV-3), Forest-40 Zone (F-40) (Summit Mountain Holding Group LLC, Applicant)

Sean Wilkinson reviewed both staff reports UVS9241D and UVS9241DP and said Phase 1D is a 20 Lot Subdivision and the access for these lots will be on a private road. There is still a need for no access lines to determine access locations. Phase 1D has a similar situation with the parking as they had with Phase 1C because of the lot sizes. Phase 1D Development Parcel D is the "Village Nest" with 20 units in this parcel. These units have garage parking spaces designated on the subdivision plat. Some of the garage units are located underneath some of the nest units and others are just stand alone garages for parking. The unit layouts are very similar to what was proposed before, and they do meet the PRUD standards for architecture. Both of these phases will have to meet all the agency review requirements.

Chair Hollist asked what the maximum height requirement is. Sean Wilkinson said the maximum height is 35 ft.

Eric Langvardt and Ray Bertoldi discussed the design elements and how they work with the land. The uits step down the hill to preserve views and they blend in with the trees.

Commissioner Warburton asked about the square footage, not including the garage. Eric Langvardt replied that these are 1800 square feet.

Chair Hollist excused Commissioner Parson from the meeting and said they still had a quorum to continue.

MOTION: Commissioner Miller moved to recommend to the County Commission approval of UVS9241D including allowing tandem or side by side parking with the requirement that they need more than 20 feet to do the side by side parking. Commissioner Warburton seconded.

VOTE: A vote was taken with all members voting aye and Chair Hollist declared motion carried (4-0).

MOTION: Commissioner Howell moved to recommend approval to the County Commission of UVS924DP subject to staff and any other agency requirements. Commissioner Warburton seconded.

VOTE: A vote was taken with all members voting aye and Chair Hollist declared that the motion carried (4-0).

3. **Public Comments for Items not on the Agenda:** Russ Watts reported on the status of the well at Powder Mountain. They are in the final stages of testing the well; they are around 180-200 gallons per minute. They still need to pass the 24 hour test. They will have an aquifer report to present later on.
4. **Remarks from Planning Commissioners:** Commissioner Warburton reported on the Utah APA Conference. This Planning Commission does a lot of administrative work that could be done by staff. She discussed streamlining a process for administrative approvals by staff so that the Planning Commission can focus on long range planning. Commissioner Howell concurred with Commissioner Warburton.

Chair Hollist brought up the Ogden Valley Charrette that will be worked on in January and February. Several professors from Utah State and Weber State will lead teams on various topics affecting Ogden Valley.

Dr. Bell scheduled Thursday at 10:00 A.M. to look at things that they are talking about in Ogden Valley.

5. **Report from the Planning Director:**
 - a. **Information Item:** Powder Mountain Park and Ride Extension: Sean Wilkinson said two years ago the Powder Mountain Park and Ride was granted a two extension through October 2013. The request is for an extension until October 2015. Two years ago when the Planning Commission approved the first extension they had indicated that staff would do the review and determine whether or not another extension would be granted. They have received some documents from Summit indicating they have been very successful with the Park and Ride. Last year there were 15, 560 riders between UTA and the Powder Mountain Shuttles. Of those riders 57% began their journey in Ogden on the bus up to the mountain. The Park and Ride lot in Eden seems to be working very well and there have not been any complaints or any problems. Staff has determined that a two year extension will be granted through October 2015, however this issued will be opened up further as part of the upcoming DRR-1 Rezone application.

Steve Clarke said he has worked with Dr. Lee Schussman and other individuals on future general planning for a transportation center that would provide the option for many people to come to Eden and be able to enjoy commercial aspects of Eden area. He is pleased with the two year extension and hoped that would continue to develop.

Rob Scott mentioned the APA UT award of merit for the Agri-Tourism Ordinance and acknowledged the Planning Commission and Scott Mendoza who was the project coordinator. The next item is that Dennis Montgomery has resigned from the Planning Commission and we have advertised for his replacement. The County Commission has made some significant decisions; they approved the Ogden Valley Pathway

Exhibit E

Commissioner Bell moved to approve Contract C2014-13, first amendment to the CityWatch Online Service Agreement extending our current contract with CityWatch for another year; Commissioner Zogmaister seconded, all voting aye.

4. **CONTRACT WITH PING4ALERTS INC., TO PROVIDE WIDER AREA EMERGENCY NOTIFICATIONS VIA CELL PHONE – CONTRACT C2014-14**

Lance Peterson, of County Emergency Management, presented this license agreement for \$20,001 through 12/31/2015 with two extensions for a \$20,000 total. He noted that alerts can now be sent to geographic areas.

Commissioner Bell moved to approve Contract C2014-14 with Ping4Alerts Inc., to provide wider area emergency notifications via cell phone; Commissioner Zogmaister seconded, all voting aye.

5. **SITE DEVELOPMENT AGREEMENT FOR \$2,475.00 FOR REMOVAL OF THE TEMPORARY TRAILER AND LANDSCAPING AT WOLF MOUNTAIN (NOW KNOWN AS SKYLINE MOUNTAIN BASE) – CONTRACT C2014-15**

Sean Wilkinson, County Planning Division Director, noted that Wolf Mountain is undergoing some changes, including a name change and updates to their site plan. The temporary trailer had been approved for up to five years and the associated landscaping was never installed. The developers have put up a financial guarantee for the removal of the trailer and the four 6 ft. pine trees in pots.

Commissioner Zogmaister moved to approve Contract C2014-15, Site Development Agreement for \$2,475.00 for the removal of the temporary trailer and landscaping at Wolf Mountain/Skyline Mountain Base; Commissioner Bell seconded, all voting aye.

6. **FINAL APPROVAL OF SUMMIT EDEN PHASES 1A, 1B, 1C, 1D, SUMMIT EDEN RIDGE NESTS –P.R.U.D., SUMMIT EDEN VILLAGE NESTS CONDOMINIUMS AND THE ROAD DEDICATION PLAT FOR SUMMIT PASS AND SPRING PARK**

Sean Wilkinson, County Planning Division Director, showed an area map. He said that these subdivision and road dedication plats for the development at Powder Mountain are complete. All the agency reviews have come back favorable, all necessary changes have been made, and the Mylar plats have been signed by the County Surveyor's Office.

In 2013 the P.R.U.D. was approved for 154 units at Powder Mountain. These phases encompass 148 of those 154 units. Six units that were in the very first phase are not being developed at this time. All P.R.U.D. and Planning Commission conditions have been addressed. The Utah Division of Drinking Water has granted plan approval of the Hidden Lake Well, construction has begun on the water tank, and Summit has filed for annexation into the Powder Mountain Water & Sewer District. The Powder Mountain District engineer has concluded his plan review and is waiting for the District Board to authorize the release of the approval letters for the upgrade of the sewer system. There are approximately 40 documents (easements, agreement, conveyances, etc.) associated with this subdivision. Some of those are still under review but will be completed and recorded at the same time as all of the plats.

Almost all of the improvement costs for the subdivision are currently in escrow but there is a shortage of approximately \$233,866.94, based on cost estimates submitted by Summit. This amount will have to be provided before all the plats can be recorded. There are only two public roads (Summit Pass and Spring Park) and construction began last year. Commissioner Bell said that this is a major milestone for this project. He noted that most county departments have been involved with it, and that county staff has put in thousands of hours into this project, which has been scrutinized from many angles, and that it is difficult for the public to grasp and see all the work that has been done. Commissioner Zogmaister echoed Commission Bell's comments about the time, effort and expertise that have been put into this project and stated that the public will see an excellent product that comes from all parties.

Tom Jolley, Executive Vice President/General Counsel for Summit Mountain Holding Group, on behalf of the developer sincerely thanked the commissioners and county staff for the thousands of hours stating that it represents a major milestone for the development. They are grateful to all county staff for the enormous amount of work. He had the signed documents by the developer that included changes requested by the County Attorney and Surveyor's Offices.

Commissioner Bell moved to grant final approval of Summit Eden Phases 1A, 1B, 1C, 1D, Summit Eden Ridge Nests – P.R.U.D., Summit Eden Village Nests Condominiums and the road dedication Plat for Summit Pass and Spring Park; Commissioner Zogmaister seconded, all voting aye.

7. REQUEST FOR CONTRACT WITH WEBER COUNTY MOSQUITO ABATEMENT DISTRICT TO PROVIDE EFFECTIVE AND EFFICIENT CORE ADMINISTRATIVE SERVICES TO THE DISTRICT

This item had been handled last week.

8. FIRST READING OF AN ORDINANCE WHICH WOULD SEPARATE THE OFFICE OF THE WEBER COUNTY RECORDER/SURVEYOR INTO SEPARATE OFFICES; WITH THE WEBER COUNTY RECORDER AND WEBER COUNTY SURVEYOR TO BE ELECTED IN THE 2014 ELECTION CYCLE, WITH THIS ORDINANCE TO TAKE EFFECT ON THE FIRST MONDAY IN JANUARY, 2015

Chair Gibson noted that a public meeting was held Friday on this item. The commissioners have been available since then to speak with those who wished to address the issue privately. The commissioners continue to study efficiency and budgetary implications. David Wilson, Deputy County Attorney, explained that if the Commission approved a first reading today they would have opportunity to consider it next week and if they did not take action today this issue could not be addressed for six years.

Commission Zogmaister noted that people have been coming to the commissioners’ offices since Friday to voice their opinions and the commissioners have also received emails and telephone calls. It has been good to hear the perspectives from those who receive the services, etc. She noted that there are differences on the proposed budgets by Mr. Rowley and Ms. Kilts; some of that is due to the philosophy on how they would run the offices and she would like those figures clarified. The reasons given for consolidation seven years ago were for efficiency and to save money and it is important to see if those have been accomplished.

Commissioner Zogmaister moved to approve the first reading of the ordinance which would separate the office of the Weber County Recorder/Surveyor into separate offices; with the Weber County Recorder and Weber County Surveyor to be elected in the 2014 election cycle, with this ordinance to take effect on the first Monday in January 2015; Commissioner Bell seconded, all voting aye.

F. ASSIGN PLEDGE OF ALLEGIANCE & THOUGHT OF THE DAY FOR TUESDAY, JANUARY 28, 2014, 10 A.M.

G. PUBLIC COMMENTS:

Jeanen Smith, Recorder/Surveyor mapper, stated that when she started working for the Recorder’s Office 20 years ago she had been impressed by the dedication and work ethic in that office. She added that all the mappers are State certified cadastral mappers.

When the offices combined in 2007, they hoped this would work and tried very hard to make it work; unfortunately it did not. She has witnessed the Recorder’s Office slide slowly down in efficiency and morale. The Recorder’s Office is down five employees and she asked why. She stated that there is no clear leadership within the Recorder’s Office. She asked why the Surveyors have a chief deputy, an administrative assistant and the elected official but the Recorder has no voice, no clear leadership. They have the knowledge and expertise but no authority was assigned to anyone to carry out those duties. Sometimes the problems pile up and there has been no authority to handle them. There is no supervisor with Recorder knowledge that is over the front counter and the chain of command has been broken. Because of this the office is not functioning efficiently. Other county offices have told her that because of some of the policies their work load has increased dramatically. The abstracts of taxpayer records have been abstracted against when there was no description, and her understanding is that a description is necessary. Over abstracting of documents can cause this problem, which she said is another current policy. Ms. Smith did not wish to portray that Mr. Rowley had intentionally caused these problems, stating that he is an excellent surveyor but thinks like a surveyor. She outlined inherent differences between the Recorder’s Office and the Surveyor’s Office, stating that there has to be a check and balance. She stated that one person cannot wear both hats in that office.



Staff Report for Administrative Approval

Weber County Planning Division

Synopsis

Application Information

Application Request: Consideration and action on a request for a one year time extension of final approval for The Summit Eden Village Nest Condominiums.

Agenda Date: Thursday, October 16, 2014

Applicant: Summit Mountain Holding Group, LLC

File Number: UVS 924DP

Property Information

Approximate Address: Powder Mountain Ski Resort (Daybreak Ridge)

Project Area: 1 Acre with 20 Units

Zoning: Forest Valley 3 Zone (FV-3) Forest-40 Zone (F-40)

Existing Land Use: Ski Resort

Proposed Land Use: Residential Condominium Subdivision

Parcel ID: 23-012-0032

Township, Range, Section: T7N, R2E, Section 8

Adjacent Land Use

| | | | |
|---------------|------------|---------------|------------|
| North: | Ski Resort | South: | Ski Resort |
| East: | Ski Resort | West: | Ski Resort |

Staff Information

Report Presenter: Jim Gentry
jgentry@co.weber.ut.us
801-399-8767

Report Reviewer: SW

Applicable Ordinances

- Weber County Land Use Code Title 106 (Subdivisions)
- Weber County Land Use Code Title 104 (Zones) Chapter 14 (FV-3 Zone)
- Weber County Land Use Code Title 104 (Zones) Chapter 9 (F-40 Zone)

Background

The Summit Eden Village Nest Condominiums (formerly Summit at Powder Mountain Phase 1D, Development Parcel D) received final subdivision approval on October 22, 2013. The applicant is requesting a 12-month time extension, as it is their intention to break ground on this phase of development in 2015, and by waiting an escrow for the improvements won't have to be given until they are ready to do the development.

Title 106 (Weber County Land Use Code) Chapter 1 Section 7(b) states: "A final subdivision plat or a phase of a subdivision that receives a recommendation for final approval from the Planning Commission shall be offered to the County Commission for final approval and recording within one (1) year from the date of the Planning Commission's recommendation for final approval. After one (1) year from that date, the plat shall have no validity. Subdivisions with multiple phases must record a new phase within one year from the date of the previous phase being recorded until the subdivision is completed or the plat shall have no validity. The Planning Director may grant a onetime extension for final subdivision approval for a maximum of one (1) year. **A multiple phase subdivision may receive only one time extension, not one time extension per phase.**"

The Summit Eden Village Nest Condominiums is the first Phase of the subdivision in need of an extension under the current subdivision ordinance regulations. If this extension is granted, the subdivision expiration date will be October 22, 2015. All of the requirements and conditions of approval for the subdivision remain unchanged.

Exhibit F

Conformance to the General Plan

The request meets the requirements of Title 106 (Weber County Land Use Code) Chapter 1 Section 7(b) and does not affect the subdivision's compliance with the Ogden Valley General Plan.

Conditions of Approval

- All of the requirements and conditions for The Summit Eden Village Nest Condominiums remain unchanged.

Administrative Approval

The request for approval of a one year time extension (through October 22, 2015) for The Summit Eden Village Nest Condominiums is hereby approved based on the request meeting the requirements of Title 106 (Weber County Land Use Code) Chapter 1 Section 7(b).



Sean Wilkinson
Weber County Planning Director



Date

Exhibits

- A. Applicant's Request Letter



October 13, 2014

Sean Wilkinson
Weber County Planning Director
2380 Washington Blvd
Ogden, UT 84401

RE: Extension Request for Summit Eden Village Nests Condominiums

Mr. Wilkinson-

It has been our pleasure working with you on the various projects at Powder Mountain. This letter is to request a one year extension of the condominium plat approval for Summit Eden Village Nests Condominiums that was approved on January 21, 2014 by the County Commission.

The plat has been approved for recording, but requires an additional \$223,866.94 escrow deposit prior to recording. It is our understanding that our current approval expires on October 17, 2014. We plan to break ground on the project next year, thus our request for the extension.

Submitted with this request is a \$300.00 check for the extension fee. Please let us know if there is any further information you require to grant the request. Thank you for all of your continued support and help with the development at Powder Mountain.

Sincerely,

A handwritten signature in blue ink, appearing to read "Russ Watts", with a horizontal line extending from the end of the signature.

Russ Watts
Watts Enterprises
5200 South Highland Drive, Suite 101
Salt Lake City, UT 84117
(801)-673-5630

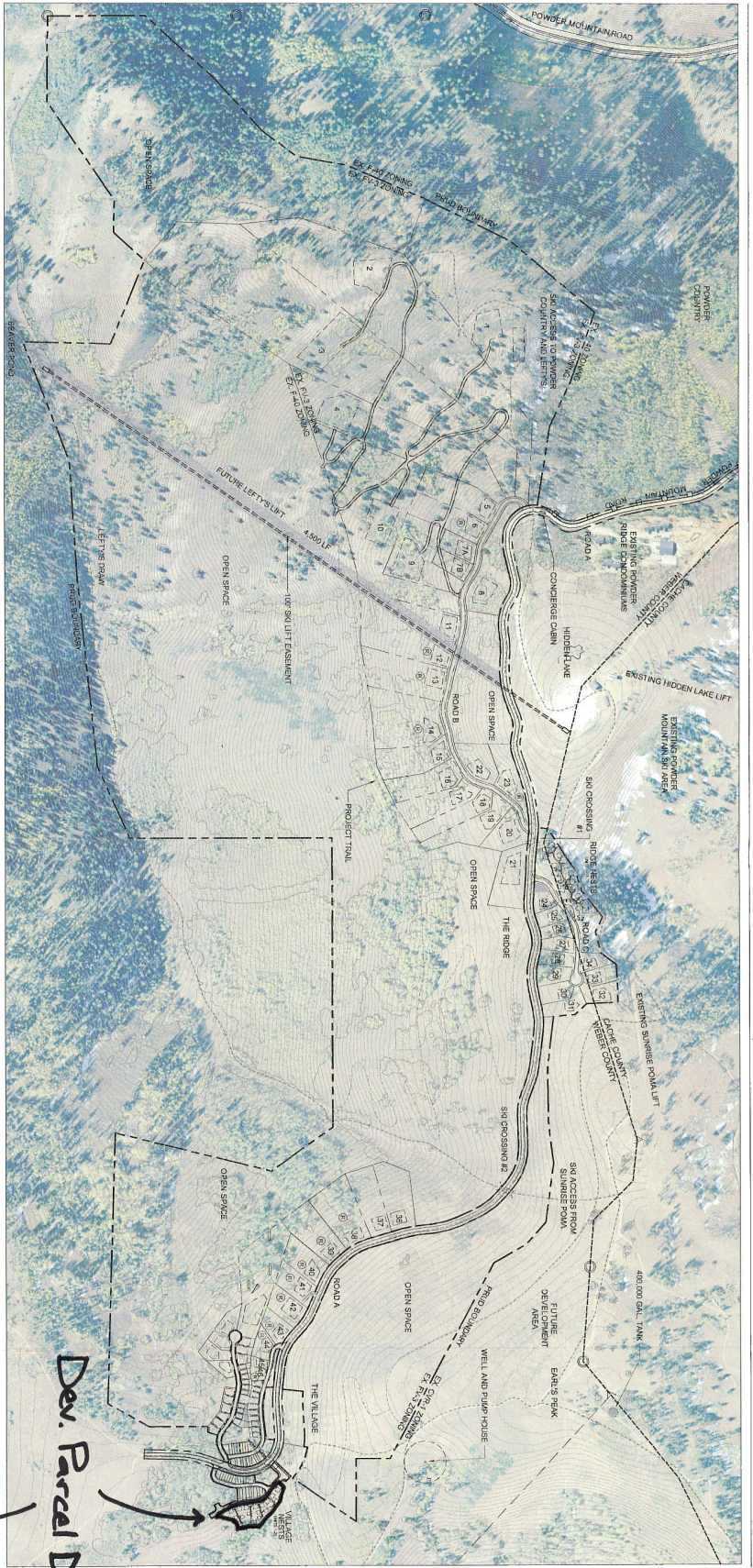

PRUD DEVELOPMENT DATA

| | |
|-----------------------------|----------------------|
| TOTAL PRUD BOUNDARY AREA | 594.23 ACRES |
| ZONE P-V-3 AREA | 392.04 ACRES |
| ZONE P-4-D AREA | 194.83 ACRES |
| ZONE CVR-1 AREA | 2.46 ACRES |
| CACHE COUNTY AREA | 4.99 ACRES |
| ROAD ROW AREA | 18.86 ACRES |
| SLOPES > 40% | 171.85 ACRES |
| NET DEVELOPABLE AREA | 463.42 ACRES |
| PROPOSED LOTS | 116 LOTS |
| PROPOSED UNITS | 154 UNITS |
| ESTATE SINGLE FAMILY | 28 UNITS |
| CABIN SINGLE FAMILY | 11 UNITS |
| HILL-SIDE SINGLE FAMILY | 35 UNITS |
| VILLAGE SINGLE FAMILY | 17 UNITS |
| VILLAGE LITERATION ST NESTS | 35 UNITS |
| PROPOSED DENSITY | 1 UNITS/89 ACRES |
| PROPOSED OPEN SPACE | 384.19 ACRES (64.6%) |

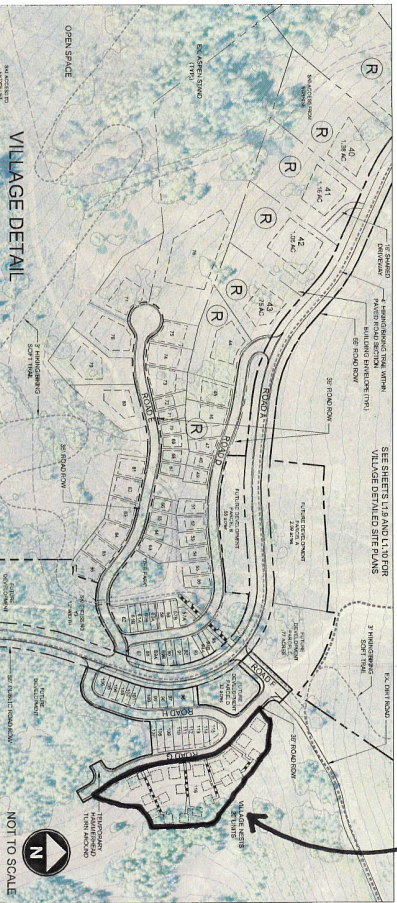

| | |
|--------------------|--------------|
| DATE: | MAY 26, 2019 |
| PROJECT: | 900200000 |
| DRAWN BY: | EL |
| REVIEW BY: | PHD |
| VERSION: | 1 |
| REVISIONS: | |
| SCALE: | AS SHOWN |
| REVISIONS: | |
| SHEET TITLE | |
| OVERALL SITE PLAN | |
| SHEET NUMBER | |
| L1.3 | |



SUMMIT EDEN
PHASE 1 PRUD SUBMITTAL

POWDER MOUNTAIN, WEBER COUNTY, UTAH



Summit Powder Mountain Village Master Plan

Summit Powder Mountain Village is the activity center for the Resort with Main Street retail shops, destination amenities such as lodges, public plazas, recreational facilities and trail heads to access the outdoors. The Summit Powder Mountain Village is modeled after small mountain villages in North American and Europe with walkable, interconnected streets and is made up of boutique hotels, condominiums, townhomes, small single family lots and "nests" making it the most diverse development area at the Resort.

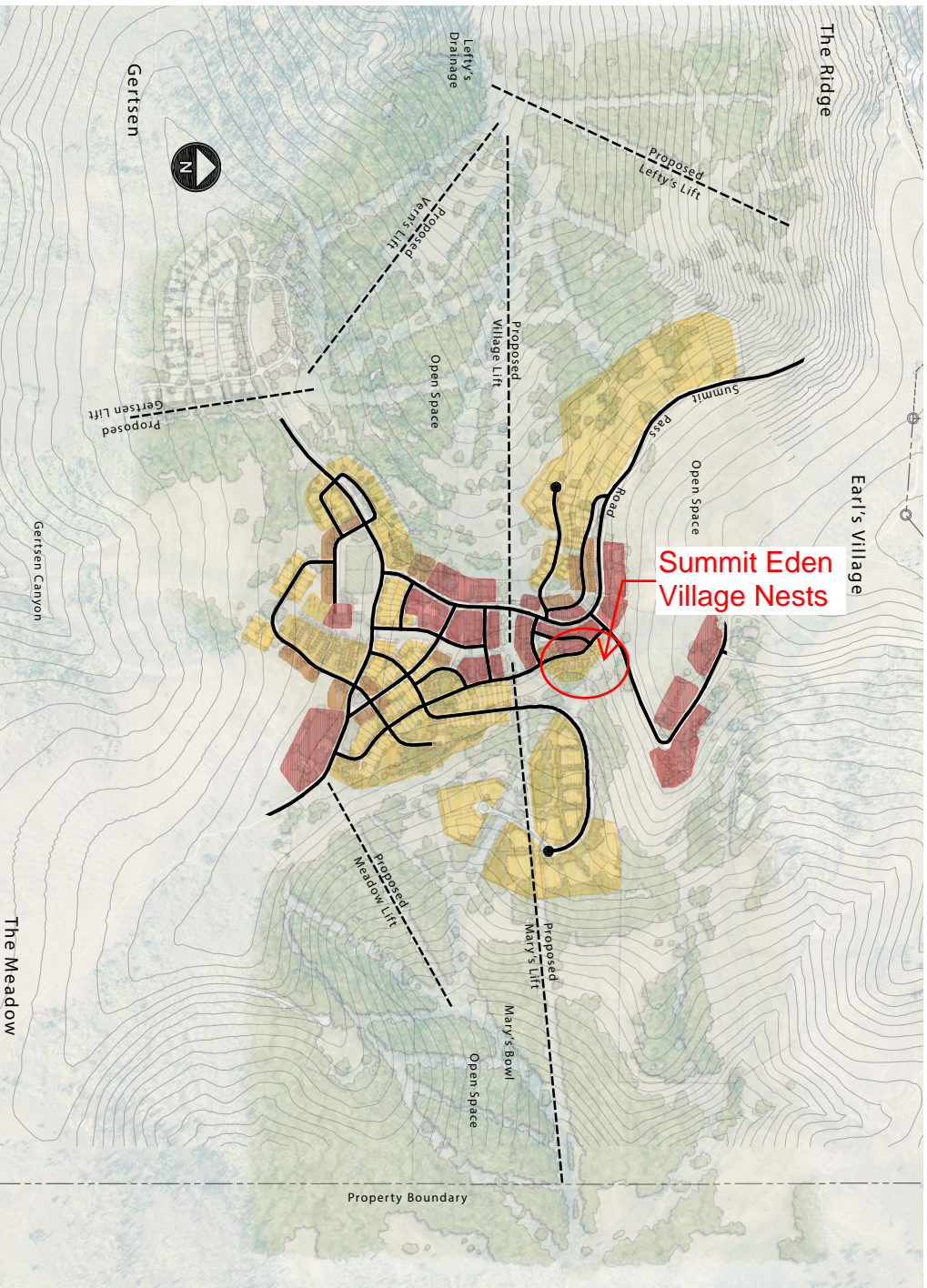

| DEVELOPMENT LEGEND | DEVELOPMENT DATA |
|--|------------------|
| MIXED USE | 580 ROOMS |
| HOTELS | 100,000 SF |
| COMMERCIAL/SKIERS SERVICES | 90 ROOMS |
| RETREATS | 150 UNITS |
| MULTI FAMILY | |
| SINGLE FAMILY | 268 UNITS |
| SINGLE FAMILY LOTS | 186 NESTS |
| NESTS | |

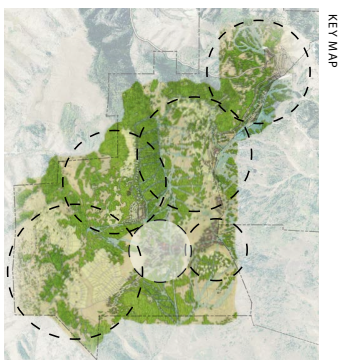



The heart of the Summit Powder Mountain Village is Main Street. Main Street will be comprised of boutique hotels and shops, residential lofts over retail, various lodges and amenities all focused around vibrant pedestrian streets littered with public spaces and access to the abundant outdoors. The Summit Powder Mountain Village was located to provide access to three drainages from its core; East to Mary's Bowl, South to Gertsen Canyon and West to Lefty's while also positioning this diverse development area to be in the least visually sensitive area on the mountain.

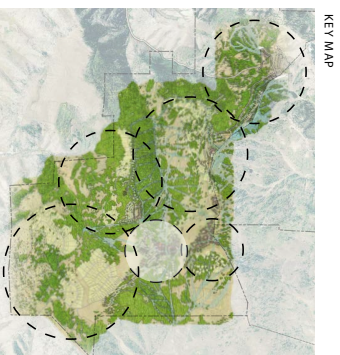

KEY MAP

Exhibit H

Findings, Conditions, and Requirements from the April 9, 2013 Staff Report to the Weber County Commission for the Summit at Powder Mountain PRUD

Conditions of Approval

The following items must be addressed prior to final subdivision approval:

- Requirements of the Weber County Engineering Division
- Requirements of the Weber Fire District
- Requirements of the Weber-Morgan Health Department
- Requirements of the Weber County Building Inspection Division
- Requirements of the State Division of Drinking Water and Division of Water Quality
- Requirements of Powder Mountain Water and Sewer Improvement District including updated sewer and culinary water feasibility letters
- Sewer capacity assessment letter verifying adequate sewer capacity for the PRUD
- Requirements of the zoning development agreement
- All development parcels must be brought under the same taxing districts
- All delinquent taxes on development parcels must be paid
- Compliance with all applicable county ordinances whether listed in this staff report or not
- Approval of the Cache County units subject to the interlocal agreement or county line adjustment being completed prior to final subdivision approval
- Compliance with Chapter 36-B (Hillside Review) lot size tables

Ogden Valley Planning Commission Recommendation

The OVPC unanimously recommended approval of this PRUD on March 19, 2013 subject to several conditions and requirements. The OVPC included the following findings, conditions, and requirements in its recommendation for approval:

OVPC Findings:

- The architectural design of the proposed housing units is acceptable and complies with the PRUD criteria of Chapter 22-D.
- Accessory buildings are not proposed for any of the single-family dwelling lots.
- The landscape plans for the village and nest areas are sufficient and comply with applicable ordinance requirements.
- The units in Cache County are approved subject to an interlocal agreement with Cache County.
- The trails master plan is acceptable subject to the developers providing access and connections to existing trails on the Weber Pathways Ogden Valley Master Plan.
- The road pattern and public/private designations are adequate; however a road maintenance agreement between the developers and Weber County is required.
- Alternative road design elements will require a variance to the Weber County Subdivision Ordinance from the County Commission.
- A secondary access road in Cache County is required.
- The Access Exception application is approved subject to meeting design requirements.
- The restricted lots meet applicable standards.
- The zoning development agreement has been complied with, but the real estate transfer fee must remain at 1.5%.
- Delinquent property taxes on property within the PRUD boundary must be paid prior to final subdivision approval from the County Commission.
- Certification is required from the Summit Eden Design Review Board that each house plan submitted for a building permit complies with their Design Guidelines and the PRUD approval.
- The site plan with 116 lots and 154 units is approved.
- PRUD variations of the FV-3 zoning requirements for lot size, setback, and building heights are approved.
- Time share/nightly rental units shall be designated on the site plan.
- The conference center on Lot 76 is approved as a non-residential accessory use.
- Parking space adjustments from two spaces to one space are allowed for the nest units.
- The conditions of approval in the staff report must be complied with.