

# Storm Water Pollution Prevention Plan

## for:

The Reserve at Crimson Ridge Cluster Subdivision Phase 2  
& Harbor View Estates Cluster Subdivision

1250 North 5200 East  
Eden, UT, 84310

## Operator:

Insert Company or Organization Name (TBD)  
Insert Name (TBD)  
Insert Address (TBD)  
Insert City, State, Zip Code (TBD)  
Insert Telephone Number (TBD)  
Insert Fax/Email (TBD)

## Primary SWPPP Contact

Insert Company or Organization Name (TBD)  
Insert Name (TBD)  
Insert Address (TBD)  
Insert City, State, Zip Code (TBD)  
Insert Telephone Number (TBD)  
Insert Fax/Email (TBD)

## SWPPP Preparation Date:

12/29/2020

## UPDES Permit Tracking Number\*:

UTR\_\_\_\_\_

*\*This is the unique number assigned to your project after you have applied for coverage under the Utah Pollutant Discharge Elimination System (UPDES) construction general permit. If this template is filled out first, you can leave the tracking number blank until after you have applied for coverage.*

## Contents

---

SECTION 1: CONTACT INFORMATION/ RESPONSIBLE PARTIES .....	1
1.1 Storm Water Team .....	1
SECTION 2: NATURE OF CONSTRUCTION ACTIVITIES .....	1
2.1 Construction Site Estimates .....	1
2.2 Construction Activity Descriptions .....	2
2.3 Phase/Sequence of Construction Activity .....	3
2.4 Maps .....	4
SECTION 3: WATER QUALITY .....	5
3.1 Discharge Information .....	5
3.2 Receiving Waters .....	5
3.3 Impaired Waters .....	5
3.4 High Water Quality .....	6
SECTION 4: POLLUTION PREVENTION STANDARDS .....	7
4.1 Potential Sources of Pollution .....	7
4.2 Non-Storm Water Discharges .....	7
4.3 Dewatering Practices .....	8
4.4 Natural Buffers or Equivalent Sediment Controls .....	9
SECTION 5: EROSION AND SEDIMENT CONTROLS – BMPS .....	11
5.1 List of Erosion and Sediment BMPs on Site .....	11
5.2 Linear Site Perimeter Control Exemption .....	15
5.3 Final Stabilization .....	15
SECTION 6: BMPS - POLLUTION PREVENTION/OPERATIONAL CONTROLS .....	16
6.1 Spill Prevention and Response .....	16
6.2 Pollution Prevention Controls .....	17
SECTION 7: SPECIAL CONDITIONS .....	18
7.1 Emergency Related Projects .....	18
7.2 UIC Class 5 Injection Wells .....	18
7.3 Chemical Treatment .....	19
SECTION 8: INSPECTIONS & CORRECTIVE ACTIONS .....	21
8.1 Inspections .....	21
8.2 Corrective Actions .....	21
8.3 Delegation of Authority .....	22
SECTION 9: RECORDKEEPING .....	22
9.1 Recordkeeping .....	22
9.2 Log of Changes to the SWPPP .....	23
SECTION 10: CERTIFICATION .....	24
Appendix A – Site Maps	
Appendix B – NOI	
Appendix C – Inspection Reports	
Appendix D – Corrective Action Report	
Appendix E – Subcontractor Certifications/Agreements/Delegation of Authority	
Appendix F – Training Logs (CGP Part 6) and Certifications	
Appendix G – Additional Information (i.e., Other permits and out of date SWPPP documents)	
Appendix H – BMP Specifications	
Appendix I – Construction General Permit	

## SECTION 1: CONTACT INFORMATION/ RESPONSIBLE PARTIES

### 1.1 Storm Water Team

Name and/or Position, and Contact	Responsibilities, Qualifications, and Training
Insert name of responsible person (TBD) Insert Company Name (TBD) Insert Position (TBD) Insert Telephone Number (TBD) Insert Email (TBD)	Insert Responsibility, Qualifications, and Trainings (TBD)
Insert name of responsible person (TBD) Insert Company Name (TBD) Insert Position (TBD) Insert Telephone Number (TBD) Insert Email (TBD)	Insert Responsibility, Qualifications, and Trainings (TBD)
Tyler Nielson Gardner Engineering P.E. Owner 801-391-8366 tyler@gecivil.com	SWPPP plan and booklet for project

## SECTION 2: NATURE OF CONSTRUCTION ACTIVITIES

### 2.1 Construction Site Estimates

The following are estimates for the construction site.

Total project area (lot size):	136.22 acres
Construction site area to be disturbed:	20.50 acres

## **2.2 Construction Activity Descriptions**

Describe the general scope of the work for the project, major phases of construction, etc:

Harbor View Estates - Cluster Subdivision is anticipated to begin March 1<sup>st</sup> 2021 starting with rough grading and be completed by September 31<sup>st</sup> or sooner. This will also include the rough grading for The Reserve at Crimson Ridge Cluster Subdivision Phase 2B and portion of Phase 2A along with installing a water tank and associated water main for the planned lots. Sewer absorption fields will be rough graded as well as will required storm water detention ponds. After rough grading for designated roadway areas and cut/fill slopes along the edge of roads is completed, sewer, storm drain, culinary water and dry utility installation will commence, followed by roadway construction and slope re-seeding.

Phase 2A is anticipated to begin April 1<sup>st</sup> 2021 and be completed by September 31<sup>st</sup> 2021 or sooner. Roadway rough grading will happen first, followed by utility installation. Roadway construction and hydroseeding disturbed slopes will occur last.

Phase 2B is anticipated to begin March 1<sup>st</sup> 2023 and be completed by September 31<sup>st</sup> 2023 or sooner. The upper detention pond will be constructed first. Any additional Phase 2B touch up rough grading for roadway should also occur (as needed). After rough grading for designated roadway areas and cut/fill slopes along the edge of roads is completed, sewer, storm drain, culinary water, and dry utility installation will commence, followed by roadway construction and slope re-seeding.

Phase 2C is anticipated to begin March 1<sup>st</sup> 2025 and be completed by September 31<sup>st</sup> 2025 or sooner. The ephemeral stream piped crossing and crossing extension should be installed when there is no water remaining in the stream (summer months). After rough grading for designated roadway areas and cut/fill slopes along the edge of roads is completed, sewer, storm drain, culinary water and dry utility installation will commence, followed by roadway construction and slope re-seeding.

These dates are subject to change based on the time frame lots are sold for the individual phases.

Describe any on-site and off-site construction support activity areas:

New water tank installation (on-site), next to existing water tank is to occur as a part of Harbor View Estates – Cluster Subdivision improvements.



Typical site business days and times:

Work days will typically be Monday – Friday (8:00 a.m. – 5:00 p.m.)

## **2.3 Phase/Sequence of Construction Activity**

Harbor View Estates – Cluster Subdivision (initial additional phase)

- Refer to section 2.2 above for description of phase and construction activities
- March 1<sup>st</sup> 2021 – September 31<sup>st</sup> 2021
- BMPs associated with this phase include:
  - Minimize disturbed area and protect natural features and soil
  - Establish perimeter controls and sediment barrier (including silt fence and inlet protection)
  - Retain sediment on-site
  - Stockpile soil/topsoil with berms around stockpiled areas.
  - Minimize dust by means of water truck during dry weather (as needed).
  - Hydroseed disturbed areas for slope stabilization (to occur in early spring or fall).
  - Protect Slopes once final grading has been completed and slopes hydroseeded.
  - Equipment and vehicles to have designated wash down area and separate fueling area.
  - Concrete waste management
  - Hazardous waste storage
  - Materials storage
  - Portable toilets
  - Spill clean up
- Stabilization methods for this phase (including temporary stabilization methods that will be used before final stabilization):
  - Establish Stabilized Construction Exits
  - Disturbed areas are to be stabilized and compacted as construction commences.
  - Additional BMPs such as rock check dams and temporary drainage swales may be used as deemed necessary by the contractor.

Phase 2A

- Refer to section 2.2 above for description of phase and construction activities
- April 1<sup>st</sup> 2021 – September 31<sup>st</sup> 2021
- BMPs associated with this phase are the same as listed above in Harbor View Estates – Cluster Subdivision.
- Stabilization methods for this phase (including temporary stabilization methods that will be used before final stabilization): (Same as in Harbor View Estates – Cluster Subdivision listed above)

Phase 2B

- Refer to section 2.2 above for description of phase and construction activities
- March 1<sup>st</sup> 2023 – September 31<sup>st</sup> 2023

- BMPs associated with this phase are the same as listed above in Harbor View Estates – Cluster Subdivision.
- Stabilization methods for this phase (including temporary stabilization methods that will be used before final stabilization): (Same as in Harbor View Estates – Cluster Subdivision listed above)

#### Phase 2C

- Refer to section 2.2 above for description of phase and construction activities
- March 1<sup>st</sup> 2025 – September 31<sup>st</sup> 2025
- BMPs associated with this phase are the same as listed above in Harbor View Estate - Cluster Subdivision.
- Stabilization methods for this phase (including temporary stabilization methods that will be used before final stabilization): (Same as in Harbor View Estates – Cluster Subdivision listed above)

## **2.4 Maps**

The SWPPP site map(s) are filed in Appendix A

## SECTION 3: WATER QUALITY

### 3.1 Discharge Information

Does your project/site discharge storm water into a Municipal Separate Storm Sewer System (MS4)?  Yes  No

List the MS4 that receives the discharge from the construction project: [UTR090022 Weber County](#)

### 3.2 Receiving Waters

#### Names of Receiving Waters

Name of Receiving Water (first surface water that receives storm water or where storm system discharges to)	Is the water impaired or high quality?	If high quality: Is it Category 1 or 2?  If impaired: List pollutants that the waterbody is impaired for
1. North Fork Ogden River and tributaries from Pineview Reservoir to headwaters ((Unnamed ephemeral stream)	<input checked="" type="checkbox"/> Not high quality/impaired <input type="checkbox"/> Impaired, has approved TMDL <input type="checkbox"/> Impaired, no TMDL <input type="checkbox"/> High quality	Anti-Degradation Category =Category 1 Assessment Category 3 = No assessment (more data required)
2. Pineview Reservoir	<input type="checkbox"/> Not high quality/impaired <input checked="" type="checkbox"/> Impaired, has approved TMDL <input type="checkbox"/> Impaired, no TMDL <input type="checkbox"/> High quality	Anti-Degradation Category =Category 1 Assessment: Category 5 Impaired: Dissolved Oxygen; Total Phosphorus

### 3.3 Impaired Waters

Description of additional precautions taken if you are discharging to an impaired surface water. State if no impairment causing pollutants are on site:

There is currently no orifice control on the existing storm water detention pond. As a part of this project's construction activities, control structures with orifice plates will be installed which will help with sediment settling out prior to being discharged into drainages that eventually drain to Pineview Reservoir. In addition to this, all disturbed soils are to be revegetated to stabilize the disturbed areas.

### **3.4 High Water Quality**

Description of additional precautions taken to minimize pollution effects if you are discharging to a high quality surface water:

BMP's will be used during construction that will include silt fence on down hill draining cut and fill slopes. Inlet protections will also be used to along with designated concrete wash out areas, portable toilets, and stabilized construction entrance. Contractor is to use proper compaction of onsite materials, provide dust control during dry periods, hydro-mulch slopes in either the early spring or fall to help prevent soil erosion form roadway cut and fill slopes. Existing vegetation is to be preserved to extent possible and be removed just prior to anticipated work commencing within the phased area of construction. Island areas by entrance features will be planted with additional attractive plantings. Erosion control methods are to be checked weekly or just prior to when a rainfall event is expected to verify, they are in good condition. Contractor is to have a designated vehicle and equipment cleaning area and fueling area that is in a remote location from any storm water discharge locations. In addition, any onsite hazardous materials shall be stored in a covered designated area that is away from potential storm drain drainages. Spills shall be immediately cleaned up and properly disposed of offsite in a legal manner. Any leaking equipment shall be properly repaired and spills from such equipment shall also be immediately cleaned up and properly disposed of offsite in a legal manner. Any BMP's not performing satisfactorily shall either be repaired, or additional BMP's implement (as needed), to prevent sediment during construction from leaving the site.

## SECTION 4: POLLUTION PREVENTION STANDARDS

### 4.1 Potential Sources of Pollution

Pollutant-Generating Activity	Pollutants or Pollutant Constituents (that could be discharged if exposed to storm water)	Location on Site (or reference SWPPP site map where this is shown)
Machinery Operating	Broken hydraulic lines or fuel lines, oil leakage.	Where construction equipment is operating.
Machinery Maintenance	Oils, fuels, other fluids	Where construction equipment is parked for the night or in staging areas or other locations where equipment is maintained.
Excavation & Earthwork	Sediment	All Disturbed Areas.
Concrete Washout	Concrete	On site. See SWPPP (Sheet C9) for location in Appendix A
Line Flushing	Sediment	New sewer and storm drain lines
Construction vehicles leaving site.	Sediment	On site. See SWPPP (Sheet C9) for phased locations in Appendix A

### 4.2 Non-Storm Water Discharges

Check allowable non-storm water discharges that are present and describe the measures used to reduce them or prevent them from contributing pollutants to discharges:

Authorized Non-Storm Water Discharges	Present	Comments/Controls
Discharges from emergency fire-fighting activities	<input type="checkbox"/> Y <input checked="" type="checkbox"/> N	
Fire hydrant flushing	<input checked="" type="checkbox"/> Y <input type="checkbox"/> N	Properly dispose of recovered flushing
Properly managed landscape irrigation (excludes fertilizer injector systems)	<input type="checkbox"/> Y <input checked="" type="checkbox"/> N	

Properly managed vehicle and equipment wash water with no soaps, solvents, or detergents	<input checked="" type="checkbox"/> Y <input type="checkbox"/> N	See BMP: Vehicle and Equipment Cleaning in Appendix H.
Water used to control dust	<input checked="" type="checkbox"/> Y <input type="checkbox"/> N	Apply water during dry periods to keep dust levels low
Drinking water, includes uncontaminated water line flushing	<input checked="" type="checkbox"/> Y <input type="checkbox"/> N	Properly dispose of recovered flushing
External building washdown with no soaps, solvents, detergents, or hazardous substances	<input type="checkbox"/> Y <input checked="" type="checkbox"/> N	
Pavement wash waters with no detergents or toxic or hazardous materials. Must have a sediment basin, sediment trap, or similarly effective control prior to discharge.	<input type="checkbox"/> Y <input checked="" type="checkbox"/> N	
Uncontaminated air conditioning or compressor condensate	<input type="checkbox"/> Y <input checked="" type="checkbox"/> N	
Uncontaminated, non-turbid discharges of ground water (from natural sources) or spring water	<input checked="" type="checkbox"/> Y <input type="checkbox"/> N	In the event that there is surface waters from spring runoff, gravel chimney drains shall be installed to divert water (as needed) with mirifi 140N fabric wrapped around the gravel to divert the water as required by the engineer.
Uncontaminated foundation or footing drains	<input type="checkbox"/> Y <input checked="" type="checkbox"/> N	

### 4.3 Dewatering Practices

Check box if section not applicable to this site (Note: If not applicable skip to next section)

Describe the general scope of dewatering practices for the project and any BMPs used to manage the dewatering practices:

N/A

4.3.1: (Place name of BMP here – reference to detailed instructions in Appendix H if necessary)

BMP Description:

<b>Installation</b>	
<b>Schedule/Instructions:</b>	
<b>Maintenance and Inspection:</b>	
<b>Responsible Staff:</b>	

***Design Specifications and  
Drawings:***

## **4.4 Natural Buffers or Equivalent Sediment Controls**

### **Buffer Compliance Alternatives**

Are there any surface waters within 50 feet of your project's earth disturbances?

YES     NO

(Note: If "no", no further documentation is required. Delete the rest of Section 4.3 below this point.)

List the water body: [Unnamed ephemeral stream](#)

### **Check the compliance alternative that you have chosen:**

I will provide and maintain a 50-foot undisturbed natural buffer around the surface water.

It is infeasible to provide and maintain a full 50-foot undisturbed natural buffer. I will provide and implement erosion and sediment controls to achieve the required sediment load reduction for my conditions.

- Reason that a 50' buffer could not be maintained: [New storm drain pipes are to be installed with Phase 2C roadway stream crossing. Other than these two crossings, the 50' buffer will be maintained. We will comply with any additional requirements related to stream alteration permit to be applied for in February 2021.](#)
- Width of buffer that will be retained: [The minimum 50' buffer will be retained with exception of where new storm drain pipe is being installed.](#)
- Additional controls used to achieve equivalent sediment load reduction of a 50' buffer: [Silt Fence and revegetation of slopes though hydromulching will be implemented. In addition, Large rock boulders will be placed at the end of the installed pipe to act as energy dissipators.](#)
- Description of the calculations and assumptions used to determine sediment load reductions: [There is an existing 60" RCP pipe under the upper stream crossing in Phase 2C. We are maintaining the same pipe flows in the stream. The existing upstream pipe will control the amount of water flowing downstream. This amount of flow will remain the same since the existing 60" RCP storm drain crossing is to remain.](#)

The project qualifies as "small residential lot" disturbing less than an acre. The natural buffer is preserved in accordance with CGP A.2.3., storm water is treated by site erosion and sediment controls before discharge, natural buffers are shown on the site map, and buffer areas are marked on site. Select one of the 2 alternatives for small residential lots:

Alternative 1: Using Table A-1 in CGP for requirements

- Width of buffer that will be retained: [N/A.](#)
- Additional controls to be used: [N/A.](#)

Alternative 2: Using Tables A-2 through A-7 in CGP for requirements

- Width of buffer that will be retained: N/A.
- Sediment Risk Level Determined: N/A.
- Additional controls to be used: N/A.

I qualify for one of the exceptions in Part A.2.2. (If you have checked this box, provide information on the applicable buffer exception that applies, below.)

There is no discharge of storm water through the area between the disturbed portions of the site and the surface water that is located within 50 feet.

No natural buffer exists due to preexisting development disturbances that occurred prior to the initiation of planning for this project.

For a linear project, site constraints (e.g., limited right-of-way) make it infeasible for me to meet any of the compliance alternatives.

- Reason it is infeasible: N/A.
- Buffer width retained or supplemental controls used: N/A.

Buffer disturbances are authorized under a CWA Section 404 permit.

- Describe earth disturbances in buffer area: N/A.

*(Note: This exception does not apply to portions upland of the Section 404 permitted work.)*

Buffer disturbances will occur for the construction of a water-dependent structure or water access area (e.g., pier, boat ramp, and trail).

- Describe earth disturbances in buffer area: N/A.



## **SECTION 5: EROSION AND SEDIMENT CONTROLS – BMPS**

### ***5.1 List of Erosion and Sediment BMPs on Site***

<b>CGP Requirement</b>	<b>Example BMPs</b>	<b>EPA SWPPP Guide Section</b>	<b>BMPs Selected (Name and Reference Number if applicable)</b>
Preserve vegetation where possible and direct storm water to vegetated areas when feasible (CGP 2.2.2.)	Phasing to minimize disturbance, signs/fences to protect areas not being disturbed.	Chapter 4, ESC Principle 1	Preservation of Existing Vegetation. (See Appendix H)
Install sediment controls along perimeter areas that receive pollutant discharges (CGP 2.2.3.).	Silt fence, fiber rolls, earth berms	Chapter 4, ESC Principle 7	Silt Fence. (See Appendix H)
Minimize sediment track-out (CGP 2.2.4.)	Restrict access, stabilize exits, track-out pads, tire washing station, clean-up sediments	Chapter 4, ESC Principle 9	Stabilized Construction Entrance. (See Appendix H)
Manage stockpiles with perimeter controls and locate away from storm water conveyances (CGP 2.2.5.)	Sediment barriers downgradient, proper location, covered stockpiles, diverting storm water from stockpiles	Chapter 4, ESC Principle 4	Silt Fence to be installed around stockpile areas. (See Appendix H)
Minimize dust (CGP 2.2.6.)	Water application, mulching, chemical dust suppression techniques		Dust Control. (See Appendix H)
Minimize steep slope disturbance (CGP 2.2.7.)	Erosion control blankets, tackifiers, protect slopes from disturbance	Chapter 4, ESC Principle 5	Hydro-mulching, Seeding and Planting. (See Appendix H)
Preserve topsoil (CGP 2.2.8.)	Stockpile topsoil	Chapter 4, ESC Principle 1	Silt Fence to be around stockpiled topsoil. (See Appendix H)
Minimize soil compaction where final cover is vegetation (CGP 2.2.9.)	Restrict vehicle access, recondition soils before seeding		Minimize soil compaction over landscaped areas.
Protect storm drain inlets (CGP 2.2.10.)	Inserts, rock-filled bags, covers	Chapter 4, ESC Principle 6	See Inlet Protection detail options. (See Appendix A, Sheet C9)
Slow down runoff with erosion controls and velocity dissipation devices (CGP 2.2.11.)	Check dams, riprap	Chapter 4, ESC Principle 3	Large boulders to be installed at ends of larger storm drain crossings. Rip rap to be installed and ends of storm drain pipe outlets.

Follow requirements for any treatment chemicals (polymers, flocculants, coagulants, etc.)	Store in leak proof containers and cover, proper training, minimize use		Materials Storage. (See Appendix H)
Stabilize exposed portions of site with 14 days of inactivity (CGP 2.2.14).	Seeding, erosion control blankets, gravel, hydromulch	Chapter 9	Hydromulching, Seeding and Planting, Temporary and Permanent Seeding, . (See Appendix H)

## 5.1.1: (Minimize Footprint – see detailed instructions in Appendix H )

**BMP Description/Instructions:** Minimize Footprint

<b>Installation Schedule:</b>	During Construction
<b>Maintenance and Inspection:</b>	Continuous
<b>Responsible Staff:</b>	Supervisor
<b>Design Specifications and Drawings:</b>	See Appendix A, sheet C11 for phased work limits.

## 5.1.2: (Perimeter Controls – see detailed instructions in Appendix H )

**BMP Description/Instructions:** Silt Fence Installation on downhill slopes

<b>Installation Schedule:</b>	Prior to demolition and earthwork excavation begins
<b>Maintenance and Inspection:</b>	Remove any collected sediments and fix/repair perimeter fencing as needed. Inspect bi-weekly and following any storm event.
<b>Responsible Staff:</b>	Supervisor
<b>Design Specifications and Drawings:</b>	See Appendix A, sheet C9 for SWPPP

## 5.1.3: (Retain Sediment On-Site – see detailed instructions in Appendix H )

**BMP Description/Instructions:** Dust Control with water truck.

<b>Installation Schedule:</b>	Apply water as needed when dust from earthwork activity is present and prior to placing base course material.
<b>Maintenance and Inspection:</b>	Maintain daily or as needed for control of dust during dry weather periods.
<b>Responsible Staff:</b>	Supervisor

## 5.1.4: (Establish Stabilized Construction Exits – see detailed instructions in Appendix H )

**BMP Description/Instructions:** Tracking Pad

<b>Installation Schedule:</b>	Prior to Construction
<b>Maintenance and Inspection:</b>	Bi-weekly and preceding and following any storm event.
<b>Responsible Staff:</b>	Supervisor
<b>Design Specifications and Drawings:</b>	See Appendix A, sheet C9 for SWPPP

## 5.1.5: (Protect Slopes – see detailed instructions in Appendix H )

**BMP Description/Instructions:** Hydromulching

<b>Installation Schedule:</b>	After slopes have been cut and 6-inch minimum topsoil has been placed.
<b>Maintenance and Inspection:</b>	Any disturbed areas or hydromulched areas shall be reseeded as needed. Contractor to water as needed to establish seeds. Reapply if needed until vegetation is established.
<b>Responsible Staff:</b>	Supervisor
<b>Design Specifications and Drawings:</b>	See Appendix A, sheet C11 for designated topsoil and hydromulch locations.

## 5.1.6: (Stockpiled Soil or Other Erodible Material – see detailed instructions in Appendix H )

**BMP Description/Instructions:** Cover, berm or use silt fence around stock piled erodible material.

<b>Installation Schedule:</b>	After materials have been stockpiled.
<b>Maintenance and Inspection:</b>	Keep covered or berms or silt fence around stockpiled erodible materials until materials have been placed. Reseed as needed any stockpiled areas.
<b>Responsible Staff:</b>	Supervisor
<b>Design Specifications and Drawings:</b>	Stock pile areas to be determined by the contractor.

## 5.1.7: (Minimize Dust – see detailed instructions in Appendix H )

**BMP Description/Instructions:** Dust Control

<b>Installation Schedule:</b>	Apply water as needed when dust from earthwork activity is present and prior to placing base course material.
<b>Maintenance and Inspection:</b>	Maintain daily or as needed for control of dust during dry weather periods.
<b>Responsible Staff:</b>	Supervisor

5.1.8: (Soil Compaction – see detailed instructions in Appendix H )

**BMP Description/Instructions: Stabilization**

<b>Installation Schedule:</b>	Throughout Construction
<b>Maintenance and Inspection:</b>	Disturbed areas within roadway and roadway embankments to compacted during construction. Landscape areas and areas to receive topsoil shall not be overly compacted.
<b>Responsible Staff:</b>	Supervisor
<b>Design Specifications and Drawings:</b>	See Appendix A, sheet C11 for designated topsoil and locations.

**5.2 Linear Site Perimeter Control Exemption**

Check box if section not applicable to this site (Note: If not applicable skip to next section)

If the site is linear and perimeter controls are not feasible, describe other practices in use:  
N/A.

**5.3 Final Stabilization**

Description of final stabilization practices and schedule:

Type of stabilization (vegetation/landscaped, graveled, paved, etc.)	Location	Implementation Schedule
Asphalt Paving	New Roadway	In designated phase
Hydro-seeding	Disturbed Landscape Areas	In designated phase during fall or early spring after topsoil has been placed (where called out on sheet C11)
Riprap and Boulders	Pipe outlets	Phase 2C immediately after storm drain pipes are installed

## SECTION 6: BMPS - POLLUTION PREVENTION/OPERATIONAL CONTROLS

### 6.1 Spill Prevention and Response

Describe spill procedures and materials available for expeditious containment, clean-up and disposal of spills:

See BMPs in Appendix H.

Identify the employee responsible for detection and response of spills and leaks:

Supervisor (TBD)

Any discharges in 24 hours equal to or in excess of the reportable quantities listed in 40 CFR 117, 40 CFR 110, and 40 CFR 302 will be reported to the National Response Center and the Division of Water Quality (DWQ) as soon as practical after knowledge of the spill is known to the permittees. The permittee shall submit within 14 calendar days of knowledge of the release a written description of: the release (including the type and estimate of the amount of material released), the date that such release occurred, the circumstances leading to the release, and measures taken and/or planned to be taken to the Division of Water Quality (DWQ), 288 North 1460 West, P.O. Box 144870, Salt Lake City, Utah 84114-4870. The Storm Water Pollution Prevention Plan must be modified within 14 calendar days of knowledge of the release to provide a description of the release, the circumstances leading to the release, and the date of the release. In addition, the plan must be reviewed to identify measures to prevent the reoccurrence of such releases and to respond to such releases, and the plan must be modified where appropriate.

Agency	Phone Number
National Response Center	(800) 424-8802
Division of Water Quality ( DWQ) 24-Hr Reporting	(801)-231-1769 (801) 536-4123
Utah Department of Health Emergency Response	(801) 580-6681

Material	Media Released To	Reportable Quantity
Engine oil, fuel, hydraulic & brake fluid	Land	25 gallons
Paints, solvents, thinners	Land	100 lbs (13 gallons)
Engine oil, fuel, hydraulic & brake fluid	Water	Visible Sheen
Antifreeze, battery acid, gasoline, engine degreasers	Air, Land, Water	100 lbs (13 gallons)
Refrigerant	Air	1 lb

## 6.2 Pollution Prevention Controls

CGP Requirements	Example BMPs	EPA SWPPP Guide Section	BMPs Selected (Name and Reference Number if applicable)
Equipment and vehicle fueling (CGP 2.3.1)	Spill kits, SPCCP, drip pans, locate activities away from conveyances, use secondary containment	Chapter 5, P2 Principle 4	Spill Clean-Up, Vehicle and Equipment Fueling. (See Appendix H)
Equipment and vehicle washing (CGP 2.3.2.)	Locating away from surface waters and storm water conveyances, directing wash waters to a sediment basin or sediment trap, using filtration devices	Chapter 5, P2 Principle 5	Vehicle and Equipment Cleaning. (See Appendix H)

6.2.1.: (Vehicle and Equipment Fueling – see detailed instructions in Appendix H if necessary)

### ***BMP Description/Instructions: Vehicle and Equipment***

<b><i>Installation Schedule:</i></b>	Prior to Construction
<b><i>Maintenance and Inspection:</i></b>	Bi-weekly
<b><i>Responsible Staff:</i></b>	Supervisor

6.2.2.: (Spill Clean-Up – see detailed instructions in Appendix H if necessary)

**BMP Description/Instructions:** Spill Clean-Up

<b>Installation Schedule:</b>	Have spill clean up kits available should a spill occur
<b>Maintenance and Inspection:</b>	Bi-weekly
<b>Responsible Staff:</b>	Supervisor

6.2.3.: (Vehicle and Equipment Cleaning – see detailed instructions in Appendix H if necessary)

**BMP Description/Instructions:** Vehicle and Equipment Cleaning

<b>Installation Schedule:</b>	Prior to Construction
<b>Maintenance and Inspection:</b>	Bi-weekly
<b>Responsible Staff:</b>	Supervisor

## SECTION 7: SPECIAL CONDITIONS

### 7.1 Emergency Related Projects

Emergency-Related Project?

Yes

No

N/A.

### 7.2 UIC Class 5 Injection Wells

Check box if section not applicable to this site (Note: If not applicable skip to next section)

Class V UIC Wells on site (all must be reported to DWQ for inventory):



- Infiltration trenches (if storm water is directed to any shaft or hole that is deeper than its widest surface dimension or has a subsurface fluid distribution system)
- Commercially manufactured pre-cast or pre-built subsurface detention vault/infiltration system
- Drywell, seepage pit, or improved sinkhole (if storm water is directed to any shaft or hole that is deeper than its widest surface dimension or has a subsurface fluid distribution system)

Description of your Class V Injection Well and any local requirements:

N/A.

Description of any additional BMPs used in conjunction with the UIC well.

7.2.1: (Place name of BMP here – reference to detailed instructions in Appendix H if necessary)

***BMP Description/Instructions:***

<b><i>Installation Schedule:</i></b>	
<b><i>Maintenance and Inspection:</i></b>	
<b><i>Responsible Staff:</i></b>	
<b><i>Design Specifications and Drawings:</i></b>	

### 7.3 Chemical Treatment

Check box if section not applicable to this site (Note: If not applicable skip to next section)

**Soil Types**

List all the soil types (including soil types expected to be found in fill material) that are expected to be exposed during construction and that will be discharged to locations where chemicals will be applied: N/A.

**Treatment Chemicals**

List all treatment chemicals that will be used at the site and explain why these chemicals are suited to the soil characteristics: N/A.

Describe the dosage of all treatment chemicals you will use at the site or the methodology you will use to determine dosage: N/A.

Provide information from any applicable Safety Data Sheets (SDS): N/A.

Describe how each of the chemicals will stored: N/A.

Include references to applicable state or local requirements affecting the use of treatment chemicals, and copies of applicable manufacturer's specifications regarding the use of your specific treatment chemicals and/or chemical treatment systems: [N/A](#).

***Special Controls for Cationic Treatment Chemicals (if applicable)***

If you have been authorized by DWQ to use cationic treatment chemicals, identify the specific controls and implementation procedures you are required to implement to ensure that your use of cationic treatment chemicals will not lead to a violation of water quality standards or harm aquatic life: [N/A](#).

***Schematic Drawings of Storm Water Controls/Chemical Treatment Systems***

Provide schematic drawings of any chemically-enhanced storm water controls or chemical treatment systems to be used for application of treatment chemicals: [N/A](#).

***Training***

Describe the training that personnel who handle and apply chemicals have received prior to permit coverage, or will receive prior to the use of treatment chemicals: [N/A](#).

## SECTION 8: INSPECTIONS & CORRECTIVE ACTIONS

### 8.1 Inspections

#### Minimum Inspection Schedule Requirements:

<b>Standard Frequency:</b>
<input checked="" type="checkbox"/> Once every 7 calendar days.
<input type="checkbox"/> Once every 14 calendar days and within 24 hours of the end of a storm event of 0.5 inches or greater. Rain gauge/weather station used: <a href="#">Gauge or station for rainfall depth</a>
<b>Increased Frequency (if applicable):</b>
<input checked="" type="checkbox"/> <i>Sites discharging to impaired or high quality waters:</i> Once every 7 calendar days and within 24 hours of the end of a storm event of 0.5 inches or greater.
<b>Decreased Frequency (if applicable):</b>
<input type="checkbox"/> <i>Arid areas:</i> once a month and within 24 hours of a 0.5 inch storm event or greater.
<input type="checkbox"/> <i>Semi-arid areas:</i> once a month and within 24 hours of a 0.5 inch storm event or greater during the dry season: <a href="#">List months for dry season</a> (also select the inspection schedule followed outside of the dry season).
<input type="checkbox"/> <i>Frozen conditions with work suspended – must have 3 months of continuous expected frozen conditions based on historical averages:</i> no inspections <a href="#">List months of suspended inspections</a> (also select the inspection schedule followed when not frozen)
<input type="checkbox"/> <i>Frozen conditions with continued activities - must have 3 months of continuous expected frozen conditions based on historical averages:</i> once per month <a href="#">List months of frozen conditions</a> (also select the inspection schedule followed when not frozen)
<b>Other:</b>
<input type="checkbox"/> Describe alternative frequency: <a href="#">List alternative schedule, must meet minimum requirements</a>

Inspection Reports are filed in Appendix C

### 8.2 Corrective Actions

Correction Action Report is filed in Appendix D.

### **8.3 Delegation of Authority**

See the signed delegation of authority forms in Appendix E.

## **SECTION 9: RECORDKEEPING**

### **9.1 Recordkeeping**

Maintain all records in Appendices A-I

The signed and certified NOI form or permit application shall be kept in Appendix B.

A copy of the construction general permit shall be kept in Appendix I

Copies of the SWPPP and all reports required by the permit must be retained for at least three years from the date that the site is finally stabilized.

## 9.2 *Log of Changes to the SWPPP*

Log here below any changes and updates to the SWPPP. Include additions of new BMPs, replacement of failed BMPs, significant changes in the activities or their timing on the project, changes in personnel, changes in inspection and maintenance procedures, updates to site maps, and so on.

Instead of using the table, SWPPPs can also be redlined to show changes as long as the redlines are initialed and dated.

<b>Description of the Amendment</b>	<b>Date of Amendment</b>	<b>Amendment Prepared by [Name(s) and Title]</b>

## SECTION 10: CERTIFICATION

### Owner

I certify under penalty of law that this document and all attachments were prepared under my direction or supervision in accordance with a system designed to assure that qualified personnel properly gathered and evaluated the information submitted. Based on my inquiry of the person or persons who manage the system, or those persons directly responsible for gathering the information, the information submitted is, to the best of my knowledge and belief, true, accurate, and complete. I am aware that there are significant penalties for submitting false information, including the possibility of fine and imprisonment for knowing violations.

Name:

Title:

---

Signature:

Date:

---

### General Contractor

I certify under penalty of law that this document and all attachments were prepared under my direction or supervision in accordance with a system designed to assure that qualified personnel properly gathered and evaluated the information submitted. Based on my inquiry of the person or persons who manage the system, or those persons directly responsible for gathering the information, the information submitted is, to the best of my knowledge and belief, true, accurate, and complete. I am aware that there are significant penalties for submitting false information, including the possibility of fine and imprisonment for knowing violations.

Name:

Title:

---

Signature:

Date:

---

## **SWPPP APPENDICES**

Attach the following documentation to the SWPPP:

***Appendix A – Site Maps***

***Appendix B – NOI***

***Appendix C – Inspection Reports***

***Appendix D – Corrective Action Report***

***Appendix E – Subcontractor***

***Certifications/Agreements/Delegation of  
Authority (see CGP 9.16(1)b.)***

***Appendix F – Training Logs and Certifications (see CGP 6)***

***Appendix G – Additional Information (i.e., Other permits such as  
dewatering, stream alteration, wetland; and out of  
date swppp documents)***

***Appendix H – BMP Instruction and Detail Specifications***

***Appendix I – Construction General Permit***

## **Appendix A: Site Maps**

Include any site maps in this appendix. For site map requirements review SWPPP section 2.5.



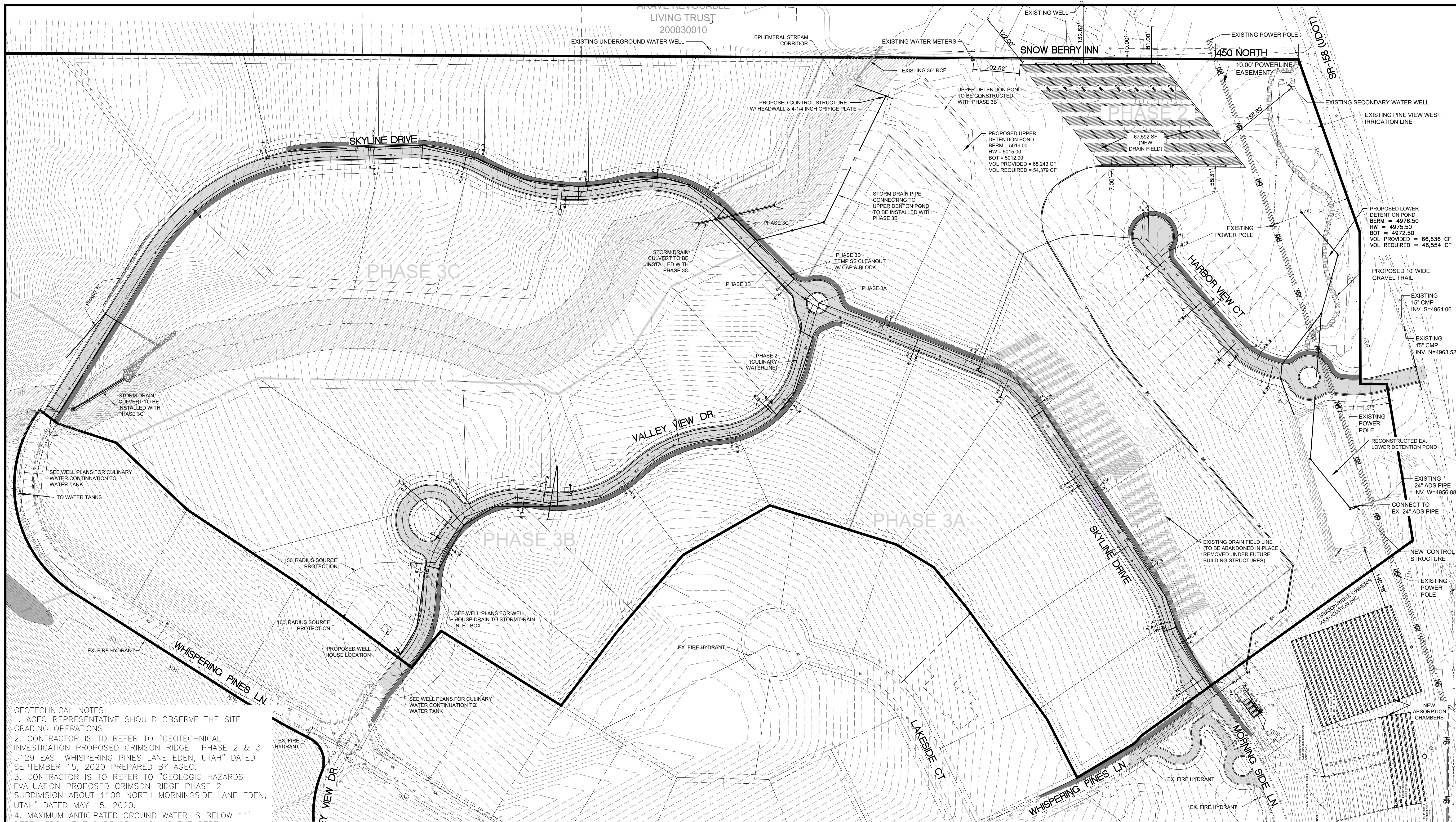

**GEOTECHNICAL NOTES:**  
 1. AGEC REPRESENTATIVE SHOULD OBSERVE THE SITE GRADING OPERATIONS.  
 2. CONTRACTOR IS TO REFER TO "GEOTECHNICAL INVESTIGATION PROPOSED CRIMSON RIDGE- PHASE 2 & 3 5129 EAST WHISPERING PINES LANE EDEN, UTAH" DATED SEPTEMBER 15, 2020 PREPARED BY AGEC.  
 3. CONTRACTOR IS TO REFER TO "GEOLOGIC HAZARDS EVALUATION PROPOSED CRIMSON RIDGE PHASE 2 SUBDIVISION ABOUT 1100 NORTH MORNINGSIDE LANE EDEN, UTAH" DATED MAY 15, 2020.  
 4. MAXIMUM ANTICIPATED GROUND WATER IS BELOW 11' DEPTH FROM THE SURFACE WHICH IS THE DEPTH INVESTIGATED WITH THE GEOTECH REPORT. EXISTING MONITORING WELLS INSTALLED WITH PHASE 1 TO VERIFY.

**ENGINEER**  
 GARDNER ENGINEERING  
 TYLER M. NIELSON  
 (801) 476-0202  
 tyler@gecivil.com

**CULINARY WATER**  
 CRIMSON RIDGE WATER COMPANY  
 801-535-4032  
 110 W. 1700 N. CENTERVILLE, UT 84014

**PUBLIC WORKS / SANITARY SEWER**  
 CHAD MEYERHOFFER (WEBER COUNTY ENGINEERING)  
 (801) 399-8004  
 cmeyerho@co.weber.ut.us

**WEBER COUNTY FIRE MARSHAL**  
 DAVID REED  
 (801) 782-3580 EXT. 205  
 dreed@weberfd.com

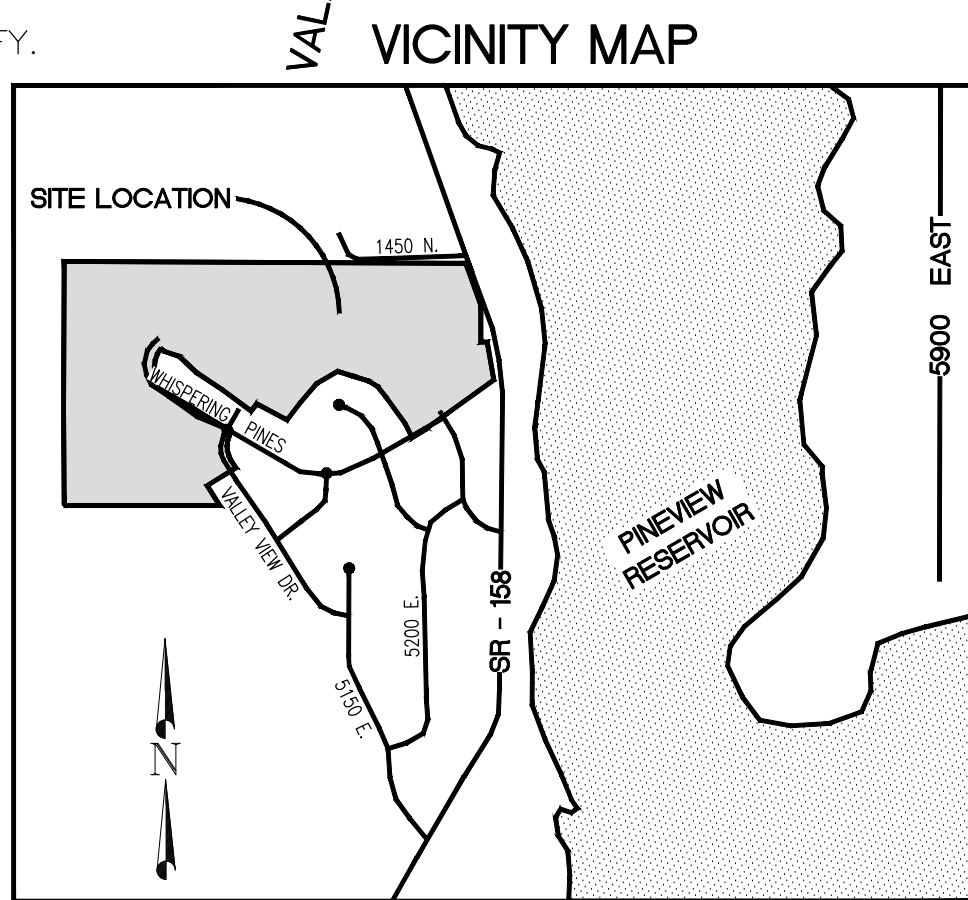

**HOUSING TYPE**  
 SINGLE FAMILY RESIDENTIAL HOMES.

1500 GALLON TANK ANTICIPATED FOR EACH LOT IN PHASE 2 (TO BE INSTALLED BY FUTURE LOT OWNER). FOR PHASE 3A, 3B, AND 3C, 2000 GALLON SEPTIC TANK TO BE INSTALLED BY FUTURE LOT OWNER.

**DEVELOPERS:**

STEVE FENTON  
 6130 E. LAST CAMP CIR.  
 SLC, UT 84108  
 801-535-4055

KEVIN DEPPE  
 110 W. 1700 N.  
 CENTERVILLE, UT 84014  
 801-535-4032

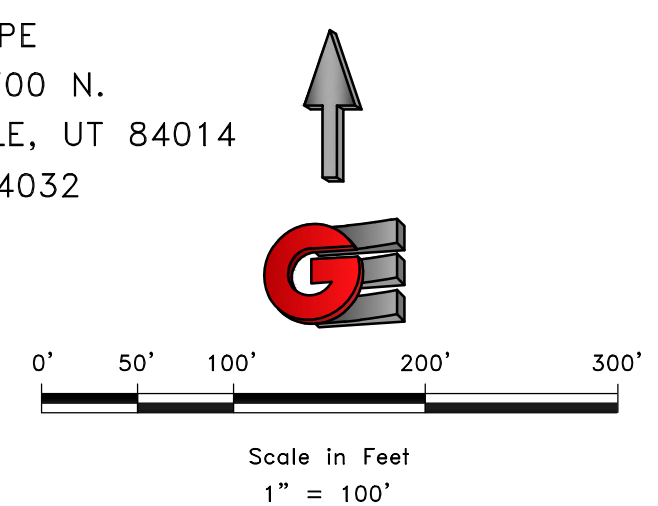

**LEGEND**

(Symbol)	SUBDIVISION BOUNDARY
(Symbol)	ROAD CENTERLINE
(Symbol)	EXISTING EDGE OF ASPHALT
(Symbol)	EXISTING 1' CONTOUR
(Symbol)	EXISTING 5' CONTOUR
(Symbol)	FINISH GRADE 1' CONTOUR
(Symbol)	EXISTING SANITARY SEWER
(Symbol)	NEW SANITARY SEWER
(Symbol)	NEW PRESSURE SEWER LATERAL
(Symbol)	EXISTING STORM DRAIN
(Symbol)	NEW STORM DRAIN
(Symbol)	EXISTING CULINARY WATER
(Symbol)	NEW CULINARY WATER
(Symbol)	NEW CULINARY WATER LATERAL
(Symbol)	NEW CULINARY WATER METER
(Symbol)	EXISTING FIRE HYDRANT
(Symbol)	NEW FIRE HYDRANT
(Symbol)	EXISTING SECONDARY WATER
(Symbol)	NEW ASPHALT PAVING

SCALE: 1" = 100'

REVISIONS	DATE	DESCRIPTION

DATE: 12/7/2020  
 DESIGN: BBD/WJS  
 DRAWN: BBD/WJS  
 CHECKED: TAN

DWG: R-0208 - BAH INVESTMENT, CRIMSON RIDGE, DESIGN, CRIMSON RIDGE - CRIMSON RIDGE - CRIMSON RIDGE - CRIMSON RIDGE

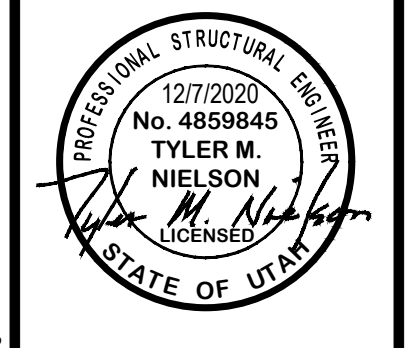

**OVERALL UTILITY PLAN**

THE RESERVE AT CRIMSON RIDGE CLUSTER SUBD. PH 2+3

1250 NORTH 5200 EAST

EDEN, WEBER COUNTY, UTAH

**GARDNER ENGINEERING**

CIVIL-LAND PLANNING  
 MUNICIPAL-LAND SURVEYING

5150 SOUTH 375 EAST OGDEN, UT  
 OFFICE: 801.476.0202 FAX: 801.476.0866

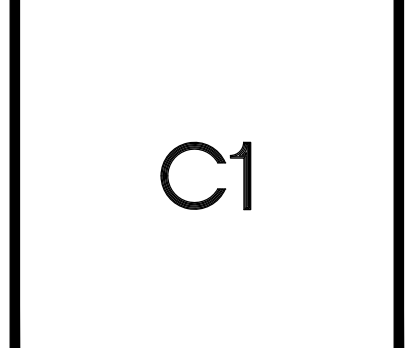



- EROSION CONTROL NOTES:**
1. SANDBAGS WILL BE PLACED AT DISCHARGE LOCATIONS TO CONTAIN AND DIVERT STORM WATER THROUGH THE INLET PROTECTION.
  2. AN EARTHEN BERM 6" HIGH WILL BE CONSTRUCTED TO CONTAIN THE STORM WATER AND DIVERT IT TO DISCHARGE AREAS.
  3. STORM WATER WILL BE DISCHARGED INTO AN EXISTING DRAINAGE SYSTEM. EXISTING LINES SHALL BE INSPECTED PRIOR TO CERTIFICATE OF OCCUPANCY AND CLEANED IF NECESSARY.
  4. THE STORM WATER POLLUTION PREVENTION PLAN SHALL CONFORM TO ALL STATE DIVISION OF ENVIRONMENTAL PROTECTION REGULATIONS.

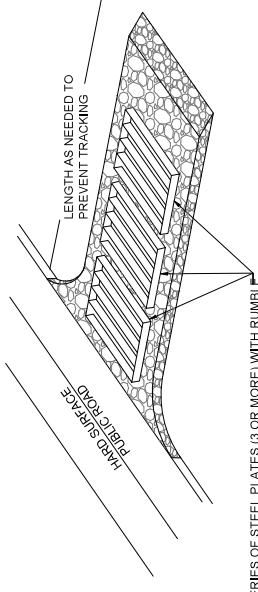

A SERIES OF STEEL PLATES (3 OR MORE) WITH RUMBLE STRIPS OR MIN. 3" COARSE AGGREGATE.

**ENTRANCE STABILIZATION NOTES:**

1. SEDIMENTS AND OTHER MATERIALS SHALL NOT BE TRACKED FROM THE SITE BY VEHICLE TRAFFIC. THE CONSTRUCTION ENTRANCE ROADWAYS SHALL BE STABILIZED SO AS TO PREVENT TRACKING OF SEDIMENTS, SLURRY OR OTHER MATERIALS DOWN BY RAIN OR OTHER MEANS INTO THE STORM DRAIN SYSTEM.
2. STABILIZED CONSTRUCTION ENTRANCE SHALL BE
  - a. LOCATED AT ANY POINT WHERE TRAFFIC WILL BE ENTERING OR LEAVING A CONSTRUCTION SITE TO OR FROM A PUBLIC RIGHT-OF-WAY, STREET, ALLEY AND SIDEWALK OR PARKING AREA.
  - b. A SERIES OF STEEL PLATES WITH "RUMBLE STRIPS", AND/OR MIN. 3" COARSE AGGREGATE WITH LENGTH, WIDTH AND THICKNESS AS NEEDED TO ADEQUATELY PREVENT TRACKING OF SEDIMENTS, SLURRY OR OTHER MATERIALS.
  3. LOCATING A WASH BACK WITH A SEPARATE TRAP LARGE ENOUGH TO COLLECT ALL WASH WATER CAN GREATLY IMPROVE EFFICIENCY.
  4. ALL VEHICLES ACCESSING THE CONSTRUCTION SITE SHALL UTILIZE THE STABILIZED CONSTRUCTION ENTRANCE SITES.

**STREET MAINTENANCE NOTES:**

1. REMOVE ALL SEDIMENT DEPOSITED ON PAVED ROADWAYS IMMEDIATELY.
2. SWEEP PAVED AREAS THAT RECEIVE CONSTRUCTION TRAFFIC WHENEVER SEDIMENT BECOMES VISIBLE.
3. WASH PAVED AREAS WITH WATER IS PROHIBITED IF IT RESULTS IN A DISCHARGE TO THE STORM DRAIN SYSTEM.

**NOTE:**

CONTRACTOR SHALL COMPLETE AND SUBMIT A STATE NOTICE OF INTENT (NOI) AND A STORM WATER POLLUTION PREVENTION PLAN BOOKLET.

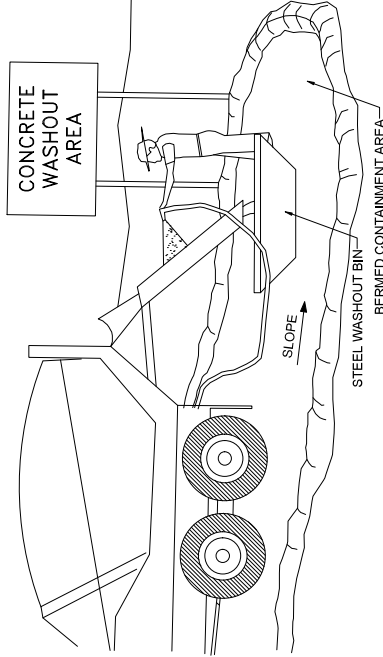

**NOTES:**

1. EXCESS AND WASTE CONCRETE SHALL BE DISPOSED OFF SITE OR AT DESIGNATED AREAS ONLY.
2. EXCESS AND WASTE CONCRETE SHALL NOT BE WASHED INTO THE STREET OR INTO A DRAINAGE SYSTEM.
3. FOR WASHOUT OF CONCRETE AND MORTAR PRODUCTS ON SITE, A DESIGNATED CONTAINMENT FACILITY OF SUFFICIENT CAPACITY TO RETAIN LIQUID AND SOLID WASTE SHALL BE PROVIDED.
4. ON-SITE CONCRETE WASHOUT CONTAINMENT FACILITY SHALL BE A STEEL BIN OR APPROVED ALTERNATE.
5. SLURRY FROM CONCRETE AND ASPHALT SAW CUTTING SHALL BE VACUUMED OR CONTAINED, DRIED, PICKED UP AND DISPOSED OF PROPERLY.



INLET PROTECTION (EITHER OPTION)

SILT FENCE

1B INLET PROTECTION - OPTION 2

Scale: NTS

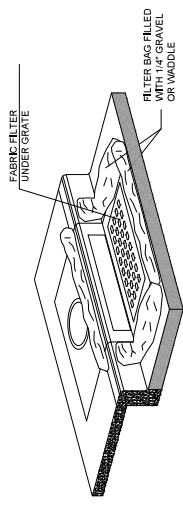

1A INLET PROTECTION - OPTION 1

Scale: NTS

- INSTALLATION NOTES:**
1. PLACEMENT PLACE CG TIGHTLY AGAINST CURB OR CURB AND COVER ENTIRE GRAVE. CG SHOULD EXTEND AT LEAST 2 INCHES PAST GRATE TOWARDS STREET.
  2. OVERLAP FOR LONG OPENINGS. OVERLAP CG UNITS AT LONGER OPENINGS.
  3. ANCHOR ANCHOR CG SO THAT WATER CANNOT FLOW BEHIND IT.
  4. ALTERNATE ANCHOR METHODS: A) INSTALL GRAVEL BAGS AT EACH SIDE OF CG - HALF-ON AND HALF-OFF THE EDGES. USE HALF-FILLED GRAVEL BAGS (15 OR 20 LBS), ROUND ROCK IS RECOMMENDED, OR B) ATTACH WITH 18 GAUGE TIE-WIRE, CUT WIRE TO 18" LENGTH, AT EACH CORNER OF CG. FEED ONE END OF WIRE DOWN THROUGH CG, AROUND GRATE BAR, AND BACK UP THRU CG, ABOVE GROUND. TWIST WIRES SEVERAL TIMES, CUT-OFF EXCESS, OR C) FASTEN WITH CONCRETE ANCHORS/NAILS AT THE OUTSIDE EDGES OF CG.

ANCHOR ALTERNATIVES SEE NOTES

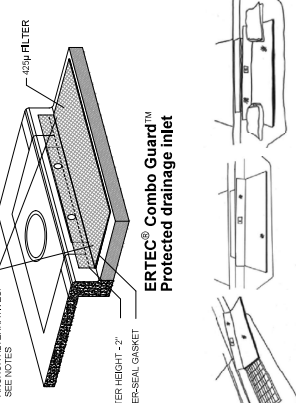

2 SILT FENCE

Scale: NTS

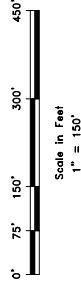
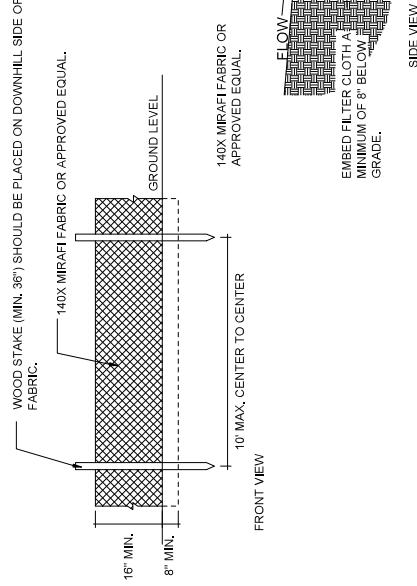

**DEVELOPERS:**

STEVE FENTON  
6130 E. LAST CAMP CIR.  
SLC, UT 84108  
801-535-4055

KEVIN DEPPE  
110 W. 1700 N.  
CENTERVILLE, UT 84014  
801-535-4032

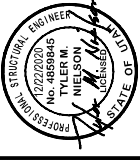

REVISIONS	DATE	DESCRIPTION

DATE	12/22/2020
DESIGN	BD/M/S
DRAWN	BD/M/S
CHECKED	T/M
DWG:	R/0208 - BIM INVESTMENT CRIMSON RIDGE DESIGN CRIMSON RIDGE - C05.DWG



DATE	DESCRIPTION
12/22/2020	DESIGN
	DRAWN
	CHECKED
	DATE
	SCALE
	REVISIONS



OVERALL GRADING PLAN (WITH PHASED WORK)  
 THE RESERVE AT CRIMSON RIDGE CLUSTER SUBD. PHASE 2  
 1250 NORTH 5200 EAST  
 EDEN, WEBER COUNTY, UTAH



C11

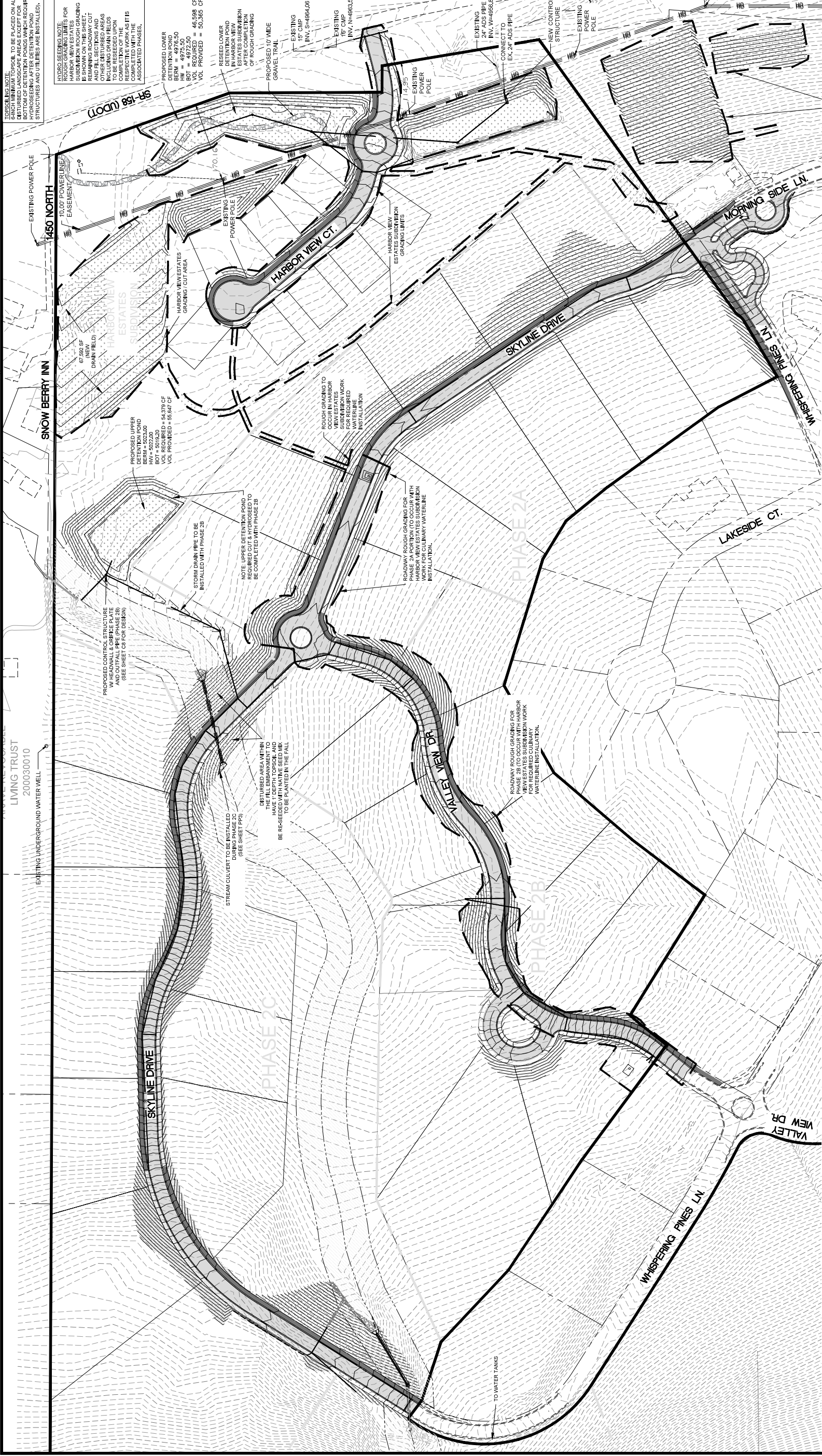

**LEGEND**

[Symbol]	ROAD CENTERLINE
[Symbol]	EXISTING EDGE OF ASPHALT
[Symbol]	EXISTING 1' CONTOUR
[Symbol]	FINISH GRADE 1' CONTOUR
[Symbol]	EXISTING SANITARY SEWER
[Symbol]	NEW SANITARY SEWER
[Symbol]	NEW PRESSURE SEWER LATERAL
[Symbol]	EXISTING STORM DRAIN
[Symbol]	NEW STORM DRAIN
[Symbol]	EXISTING CULINARY WATER
[Symbol]	NEW CULINARY WATER
[Symbol]	NEW CULINARY WATER LATERAL
[Symbol]	EXISTING FIRE HYDRANT
[Symbol]	NEW FIRE HYDRANT
[Symbol]	EXISTING SECONDARY WATER
[Symbol]	NEW ASPHALT PAVING
[Symbol]	6" DEPTH CUT AREA OVER EX. & 6" TOPSOIL WITH HYDROSEED
[Symbol]	OR 6" TRAIL MATERIAL PLACEMENT (HYDRO SEED IN DESIGNATED PHASE)
[Symbol]	HYDROSEED FILL SLOPE OR BOTTOM OF DETENTION POND

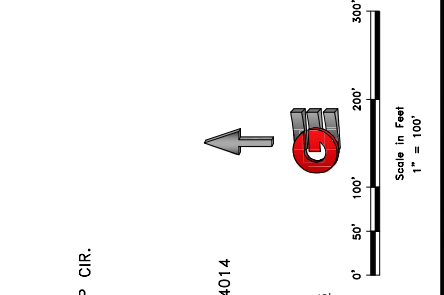

**DEVELOPERS:**  
 STEVE FENTON  
 6130 E. LAST CAMP CIR.  
 SLC, UT 84108  
 801-535-4055  
 KEVIN DEPPE  
 110 W. 1700 N.  
 CENTERVILLE, UT 84014  
 801-535-4032

**ENGINEER**  
 GARDNER ENGINEERING  
 TYLER W. NIELSON  
 (801) 476-0202  
 tyler@gcewill.com

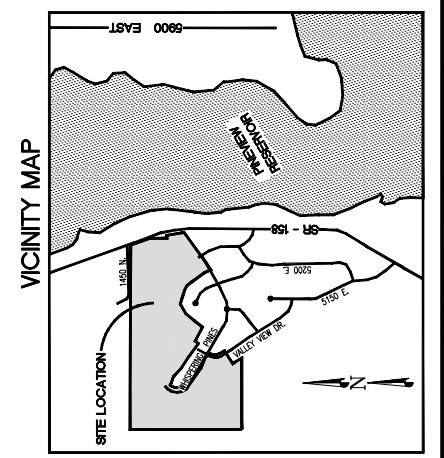

**EARTHWORK NET LINE QUANTITIES**  
 HARBOR VIEW ESTATES SUBDIVISION (INCLUDES HARBOR VIEW ESTATES SUBDIVISION WITH EXCEPTION OF UPPER DETENTION POND. ALSO INCLUDES PHASE 2B AND PORTION OF PHASE 2A ROUGH GRADING):  
 UNADJUSTED CUT VOLUME (RAW) = 25,793 CY  
 UNADJUSTED FILL VOLUME (RAW) = 30,285 CY  
 ADJUSTED FILL VOLUME (FOR IMPORTED PAVEMENT SECTION AND TRAILS) = 25,195 CY

HARBOR VIEW ESTATES (W/PH 2B AND PORTION OF PH 2A) OVERALL NET CUT = 599 CY  
 TOPSOIL REMOVAL, STOCKPILING & RESPREADING TOPSOIL, 6-INCH OVEREX FOR CUT EMBANKMENTS AND GRAVEL TRAIL (IS INCIDENTAL TO EARTHWORK CUT AND FILL)  
 ESTIMATED SEWER POND & CHAMBER ADDITIONAL CUT DURING HARBOR VIEW ESTATES WORK = 3,031 CY  
 (EXCESS CUT TO BE STOCKPILED ON LOT 42)

(FUTURE AND REMAINING PORTION OF PHASES FOR EARTHWORK)  
 PHASE 2A CUT 5,783 CY  
 PHASE 2A FILL 8,679 CY  
 PHASE 2B CUT 2,488 CY  
 PHASE 2B FILL 6,138 CY  
 PHASE 2C CUT 19,298 CY  
 PHASE 2C FILL 3,489 CY  
 ADJUSTED FILL 3,079 CY  
 21,110 CY

(OVERALL NET CUT FOR REMAINING PHASES 870 CY CUT  
 (SOIL SHRINKAGE FACTOR OR UTILITY TRENCHING SPOILS QUANTITIES NOT CALCULATED).

**POSTGRADING NOTE:**  
 FINISH MINIMUM TOPSOIL TO BE PLACED ON ALL DISTURBED LANDSCAPE AREAS EXCEPT FOR HYDROSEEDING AREAS. HYDROSEEDING REQUIRE HYDROSEEDING AFTER DETENTION POND STRUCTURES AND UTILITIES ARE INSTALLED.

**HYDRO SEEDING NOTE:**  
 ROUGH GRADING LIMITS FOR HARBOR VIEW ESTATES SUBDIVISION ARE SHOWN ON THIS SHEET. REMAINING ROADWAY CUT AND FILL ARE SHOWN ON OTHER SHEETS INCLUDING DRAIN FIELDS TO BE RESEED UPON COMPLETION OF RESPECTIVE WORK AS IT IS ASSOCIATED WITH THE ASSOCIATED PHASES.

PROPOSED LOWER DETENTION POND BERM = 4976.50  
 BOT = 4872.50  
 VOL REQUIRED = 46,598 CF  
 VOL PROVIDED = 50,365 CF

RESEED LOWER DETENTION POND ESTATES SUBDIVISION AFTER COMPLETION OF ROUGH GRADING

PROPOSED 10' WIDE GRAVEL TRAIL

EXISTING 15" CMP INV. S=4894.06  
 EXISTING 18" CMP INV. N=4863.52

EXISTING 24" ADS PIPE INV. W=4866.88  
 EXISTING 24" ADS PIPE INV. W=4866.88  
 CONNECT TO EX. 24" ADS PIPE

NEW CONTROL STRUCTURE

EXISTING POWER POLE

PROPOSED UPPER DETENTION POND BERM = 5022.00  
 HW = 5022.00  
 BOT = 4918.00  
 VOL REQUIRED = 54,370 CF  
 VOL PROVIDED = 55,847 CF

ROUGH GRADING TO OCCUR WITH HARBOR VIEW ESTATES SUBDIVISION WORK FOR CULINARY WATERLINE INSTALLATION

ROADWAY ROUGH GRADING FOR PHASE 2A PORTION TO OCCUR WITH HARBOR VIEW ESTATES SUBDIVISION WORK FOR CULINARY WATERLINE INSTALLATION.

STORM DRAIN PIPE TO BE INSTALLED WITH PHASE 2B

USE UPPER DETENTION POND REQUIRED CUT & HYDROSEED TO BE COMPLETED WITH PHASE 2B

PROPOSED CONTROL STRUCTURE AND OUTFALL PIPE (PHASE 2B) (SEE SHEET C8 FOR DESIGN)

DEVELOPED AREAS WITHIN 1' DEPTH TOPSOIL AND BE RESEED WITH NATIVE SEED MIX TO BE PLANTED IN THE FALL

STREAM CULVERT TO BE INSTALLED (SEE SHEET P2)

TO WATER TANKS

SR-158 (UDOT)

1450 NORTH

SNOW BERRY INN

HARBOR VIEW ESTATES SUBDIVISION

HARBOR VIEW ESTATES GRADING CUT AREA

HARBOR VIEW ESTATES GRADING LIMITS

SKYLINE DRIVE

VALLEY NEW DR

WHISPERING PINES LN

LAKESIDE CT.

MORNING SIDE LN

VALLEY NEW DR

EXISTING UNDERGROUND WATER WELL

LIVING TRUST 2000330010



## **Appendix B: NOI**

Include a copy of your NOI in this appendix. The NOI must be signed.

## Appendix C: Inspection Reports

Place all completed inspection reports in this appendix. You may also put blank inspection reports here to be completed.

You are encouraged to create your own inspection forms for each site. Inspection reports must have the following information:

- 1) The inspection date.
- 2) The UPDES ID number (UTRXXXXX).
- 3) Name and title of personnel making the inspections.
- 4) Summary of inspection findings and any necessary corrective actions:
  - a. Are storm water controls properly installed and operational? If failed then why?
  - b. Presence of any conditions that could lead to spills or leaks.
  - c. Locations where new or modified controls are necessary.
  - d. Signs of visible erosion or sediment depositing related to your discharges.
  - e. Any incidents of noncompliance.
  - f. Visual quality of any discharges occurring.
- 5) Rainfall amount if the inspection was triggered by a precipitation event.
- 6) If it was unsafe to inspect any areas of the site, a description of the area and reason.

## **Appendix D: Corrective Action Report**

An example corrective action report has been included in this appendix. Review SWPPP section 8.2 for corrective action requirements. You can also create your own form or include corrective actions on your inspection form.

## Appendix D – *Sample* Corrective Action Report

Inspection Date	Inspector Name(s)	Description of BMP Deficiency	Corrective Action Needed (including planned date/responsible person)	Date Action Taken/Responsible person

## **Appendix E: Subcontractor Certifications/Agreements/Delegation of Authority (CGP 9.16.(1)b.)**

A sample subcontractor agreement form and delegation of authority form have been included in this appendix. If these are used, keep complete signed forms here.



SUBCONTRACTOR CERTIFICATION  
STORM WATER POLLUTION PREVENTION PLAN

Project Number: \_\_\_\_\_

Project Title: The Reserve at Crimson Ridge Cluster Subdivision Phase 2 & Harbor View Estates – Cluster Subdivision

Operator(s): \_\_\_\_\_

As a subcontractor, you are required to comply with the Storm water Pollution Prevention Plan (SWPPP) for any work that you perform on-site. Any person or group who violates any condition of the SWPPP may be subject to substantial penalties or loss of contract. You are encouraged to advise each of your employees working on this project of the requirements of the SWPPP. A copy of the SWPPP is available for your review at request.

Each subcontractor engaged in activities at the construction site that could impact storm water must be identified and sign the following certification statement:

**I certify under the penalty of law that I have read and understand the terms and conditions of the SWPPP for the above designated project and agree to follow the BMPs and practices described in the SWPPP.**

This certification is hereby signed in reference to the above named project:

Company: \_\_\_\_\_

Address: \_\_\_\_\_

Telephone Number: \_\_\_\_\_

Type of construction service to be provided: \_\_\_\_\_

\_\_\_\_\_

Signature: \_\_\_\_\_

Title: \_\_\_\_\_

Date: \_\_\_\_\_

### Delegation of Authority

I, \_\_\_\_\_, hereby designate the person or specifically described position below to be a duly authorized representative for the purpose of overseeing compliance with environmental requirements, including the UPDES "General Permit for Storm Water Discharges Associated with Construction Activity" (CGP), at the construction site:

\_\_\_\_\_, Permit No. UTR \_\_\_\_\_

The designee is authorized to sign all reports required by the Permit and other information requested by the Director of the Utah Division of Water Quality, or by an authorized representative of the Executive Secretary.

Name of Person or Position: \_\_\_\_\_

Owner/Operator: \_\_\_\_\_

Mailing Address: \_\_\_\_\_

City, State, Zip Code: \_\_\_\_\_

Phone Number: \_\_\_\_\_

By signing this authorization, I confirm that I meet the requirements to make such a designation as set forth in Part 9.16 of the CGP, and that the designee above meets the definition of a "duly authorized representative" as set forth in Part 9.16.b. of the CGP.

I certify under penalty of law that this document and all attachments were prepared under my direction or supervision in accordance with a system designed to assure that qualified personnel properly gather and evaluate the information submitted. Based on my inquiry of the person or persons who manage the system, or those persons directly responsible for gathering the information, the information submitted is, to the best of my knowledge and belief, true, accurate, and complete. I am aware that there are significant penalties for submitting false information, including the possibility of fine and imprisonment for knowing violations.

Name: \_\_\_\_\_

Title: \_\_\_\_\_

Signature: \_\_\_\_\_

Date: \_\_\_\_\_

## **Appendix F: Training Logs and Certifications (see CGP 6)**

A sample training log has been included in this appendix to keep track of trainings that have been provided. At a minimum, storm water team members that require training should be provided with the following if it relates to their duties (CGP Part 6.3.):

- The permit deadlines associated with installation, maintenance, and removal of storm water controls and with stabilization;
- The location of all storm water controls on the site required by this permit and how they are to be maintained;
- The proper procedures to follow with respect to the permit's pollution prevention requirements; and
- When and how to conduct inspections, record applicable findings, and take corrective actions

Certifications for SWPPP inspectors or writers can also be placed in this appendix.

## Appendix F – *Sample* SWPPP Training Log

### Storm Water Pollution Prevention Training Log

Project Name: \_\_\_\_\_

Project Location: \_\_\_\_\_

Instructor's Name(s): \_\_\_\_\_

Instructor's Title(s): \_\_\_\_\_

Course Location: \_\_\_\_\_ Date: \_\_\_\_\_

Course Length (hours): \_\_\_\_\_

Storm Water Training Topic: *(check as appropriate)*

- Erosion Control BMPs
- Emergency Procedures
- Sediment Control BMPs
- Good Housekeeping BMPs
- Non-Storm Water BMPs

Specific Training Objective: \_\_\_\_\_  
\_\_\_\_\_

Attendee Roster: *(attach additional pages as necessary)*

No.	Name of Attendee	Company
1		
2		
3		
4		
5		
6		
7		
8		
9		
10		

## **Appendix G: Additional Information**

Use this appendix for additional information such as other permits (dewatering, stream alteration, etc.) or out of date SWPPP documents.

Stream Alteration Permit to be submitted February 2021, which pertains to Phase 2C.

## **Appendix H: BMP Instruction and Detail Specifications**

Use this appendix if complete BMP specifications are not provided in Section 5 or 6 of the SWPPP.

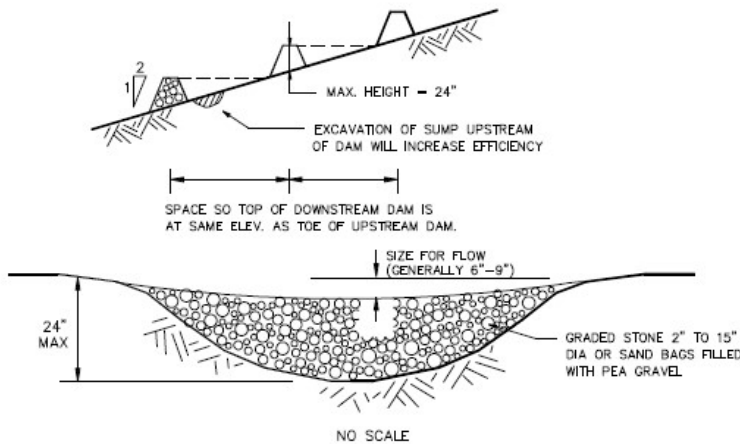

## DESCRIPTION:

A small, temporary dam constructed across a drainage ditch to reduce velocity of concentrated storm water flows, thereby reducing the erosion of the ditch.

## APPLICATION:

- ▶ Temporary drainage paths
- ▶ Permanent drainage ways not yet stabilized
- ▶ Existing drainage paths receiving increased flows due to construction

## INSTALLATION/APPLICATION CRITERIA:

- ▶ Prepare location of dam by removing any debris and rough grading any irregularities in channel bottom
- ▶ Place rocks by hand or with appropriate machinery, do not dump
- ▶ Construct dam with center lower to pass design flow
- ▶ Construct 50% side slopes on dam

## LIMITATIONS:

- ▶ Maximum recommended drainage area is 10 acres
- ▶ Maximum recommended height is 24"
- ▶ Do not use in running stream

## MAINTENANCE:

- ▶ Inspect dams daily during prolonged rainfall, after each major rain event and at a minimum of once monthly.
- ▶ Remove any large debris and repair any damage to dam, channel or sideslopes
- ▶ Remove accumulated sediment when it reaches one half the height of the dam

## OBJECTIVES

- Housekeeping Practices
- Contain Waste
- Minimize Disturbed Areas
- Stabilize Disturbed Areas
- Protect Slopes/Channels
- Control Site Perimeter
- Control Internal Erosion



# WEBER COUNTY

## ENGINEERING DEPARTMENT

2380 Washington Blvd., Suite 240  
Ogden, UT 84401  
(801) 399-8374

## TARGETED POLLUTANTS

- Sediment
- Nutrients
- Toxic Materials
- Oil & Grease
- Floatable Materials
- Other Waste

- High Impact
- Medium Impact
- Low or Unknown Impact

## IMPLEMENTATION REQUIREMENTS

- Capital Costs
- O&M Costs
- Maintenance
- Training

- High
- Medium
- Low

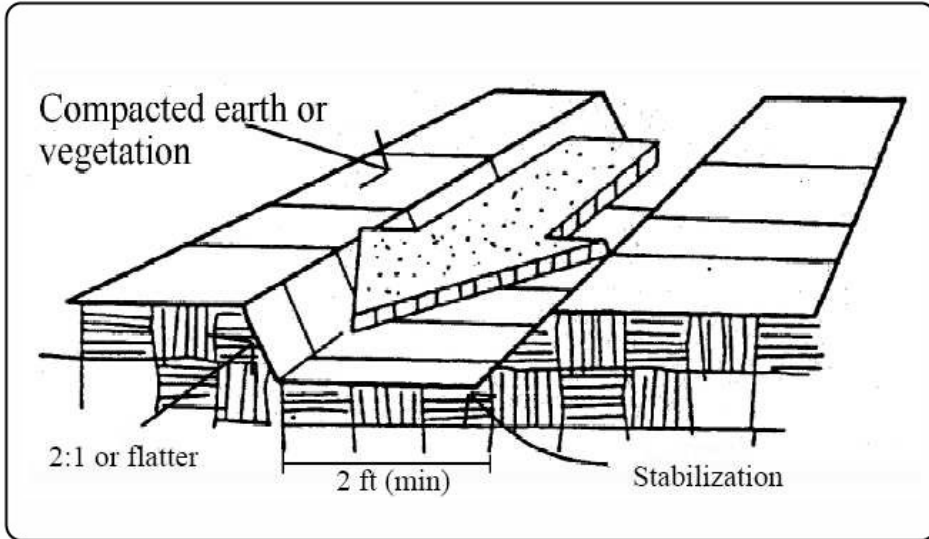

## DESCRIPTION:

Temporary drains and swales are used to divert off-site runoff around the construction site, divert runoff from stabilized areas around disturbed areas, and direct runoff into sediment.

## APPLICATIONS:

- ▶ Temporary drains and swales are appropriate for diverting any upslope runoff around unstabilized or disturbed areas of the construction site.
- ▶ Prevent slope failures. Prevent damage to adjacent property. Prevents erosion and transport of sediments into water ways. Increases the potential for infiltration. Diverts sediment-laden runoff into sediment basins or traps.

## INSTALLATION/APPLICATION:

- ▶ Temporary drainage swales will effectively convey runoff and avoid erosion if built properly:
- ▶ Size temporary drainage swales using local drainage design criteria. A permanent drainage channel must be designed by a professional engineer (see the local drainage design criteria for proper design).
- ▶ At a minimum, the drain/swale should conform to predevelopment drainage patterns and capacities.
- ▶ Construct the drain/swale with an uninterrupted, positive grade to a stabilized outlet. Provide erosion protection or energy dissipation measures if the flow out of the drain or swale can reach an erosive velocity.

## LIMITATIONS:

- ▶ Temporary drains and swales or any other diversion of runoff should not adversely impact upstream or downstream properties.
- ▶ Temporary drains and swales must conform to local floodplain management requirements.

## MAINTENANCE:

- ▶ Inspect weekly and after each rain.
- ▶ Repair any erosion immediately.
- ▶ Remove sediment which builds up in the swale and restricts its flow capacity.

## OBJECTIVES

- Housekeeping Practices
- Contain Waste
- Minimize Disturbed Areas
- Stabilize Disturbed Areas
- Protect Slopes/Channels
- Control Site Perimeter
- Control Internal Erosion



# WEBER COUNTY

## ENGINEERING DEPARTMENT

2380 Washington Blvd., Suite 240  
Ogden, UT 84401  
(801) 399-8374

## TARGETED POLLUTANTS

- Sediment
- Nutrients
- Toxic Materials
- Oil & Grease
- Floatable Materials
- Other Waste

- High Impact
- Medium Impact
- Low or Unknown Impact

## IMPLEMENTATION REQUIREMENTS

- Capital Costs
- O&M Costs
- Maintenance
- Training

- High
- Medium
- Low



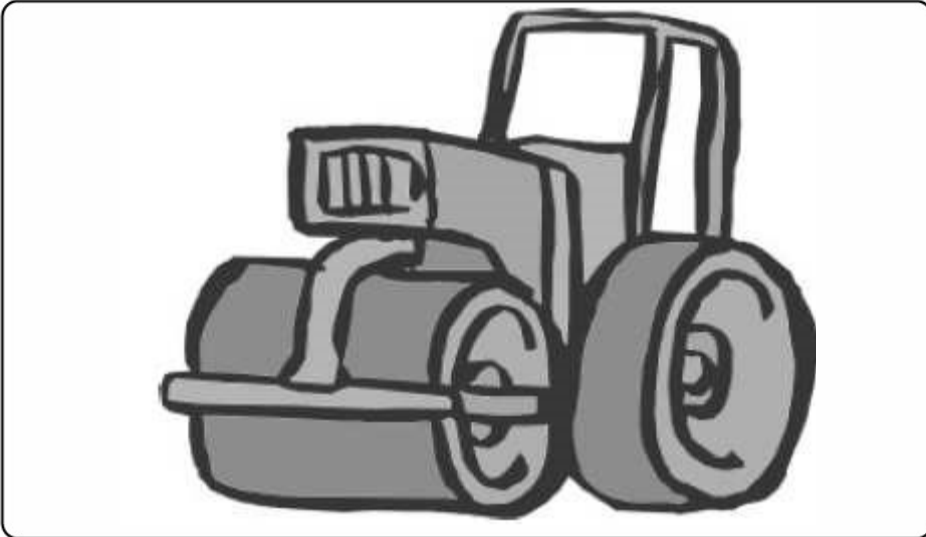

**DESCRIPTION:**

Use of rolling, tamping, or vibration to stabilize fill materials and control erosion by increasing the soil density. Increasing the density of soil improves soil strength, reduces long-term soil settlement, and provides resistance to erosion.

**APPLICATIONS:**

- ▶ Stabilize fill material placed around various structures.
- ▶ Improve soil in place as foundation support for roads, parking lots, and buildings.

**INSTALLATION/APPLICATION CRITERIA:**

- ▶ Make sure soil moisture content is at optimum levels.
- ▶ Use proper compaction equipment.
- ▶ Install sediment control and storm water management devices below compacted areas and runoff interceptor devices above these areas. Drainage from compacted areas must be carefully planned to protect adjacent uncompacted soils.
- ▶ The surface of compacted areas should be scarified and seeded or mulched and seeded to increase the effectiveness of compaction.

**LIMITATIONS:**

- ▶ Compaction tends to increase runoff.
- ▶ Over-compaction will hamper revegetation efforts.

**MAINTENANCE:**

- ▶ No maintenance required.

**OBJECTIVES**

- Housekeeping Practices
- Contain Waste
- Minimize Disturbed Areas
- Stabilize Disturbed Areas
- Protect Slopes/Channels
- Control Site Perimeter
- Control Internal Erosion



**WEBER COUNTY**

**ENGINEERING DEPARTMENT**

2380 Washington Blvd., Suite 240  
Ogden, UT 84401  
(801) 399-8374

**TARGETED POLLUTANTS**

- Sediment
- Nutrients
- Toxic Materials
- Oil & Grease
- Floatable Materials
- Other Waste

- High Impact
- Medium Impact
- Low or Unknown Impact

**IMPLEMENTATION REQUIREMENTS**

- Capital Costs
- O&M Costs
- Maintenance
- Training

- High
- Medium
- Low



## OBJECTIVES

- New Development
- Residential
- Commercial Activities
- Industrial Activities
- Municipal Facilities
- Illegal Discharges



# WEBER COUNTY

## ENGINEERING DEPARTMENT

2380 Washington Blvd., Suite 240  
Ogden, UT 84401  
(801) 399-8374

## DESCRIPTION:

Prevent or reduce the discharge of pollutants to stormwater from contaminated or erodible surface areas by leaving as much vegetation on-site as possible, minimizing soil exposure time, stabilizing exposed soils, and preventing stormwater runoff and runoff.

## APPROACH:

This BMP addresses soils which are not so contaminated as to exceed criteria but the soil is eroding and carrying pollutants off in the stormwater.

Contaminated or erodible surface areas can be controlled by:

- ▶ Preservation of natural vegetation,
- ▶ Re-vegetation,
- ▶ Chemical stabilization,
- ▶ Removal of contaminated soils, or
- ▶ Geosynthetics.

## LIMITATIONS:

Disadvantages of preserving natural vegetation or re-vegetating include:

- ▶ Requires substantial planning to preserve and maintain the existing vegetation.
- ▶ May not be cost-effective with high land costs.
- ▶ Lack of rainfall and/or poor soils may limit the success of re-vegetated areas.

Disadvantages of chemical stabilization include:

- ▶ Creation of impervious surfaces.
- ▶ May cause harmful effects on water quality.
- ▶ Is usually more expensive than vegetative cover.

## MAINTENANCE:

- ▶ Maintenance should be minimal, except if irrigation of vegetation is necessary.

## TARGETED POLLUTANTS

- Sediment
- Nutrients
- Heavy Metals
- Toxic Materials
- Oxygen Demanding Substance
- Oil & Grease
- Floatable Materials
- Bacteria & Viruses
- High Impact
- Medium Impact
- Low or Unknown Impact

## IMPLEMENTATION REQUIREMENTS

- Capital Costs
- O&M Costs
- Regulatory
- Training
- Staffing
- Administrative
- High
- Medium
- Low

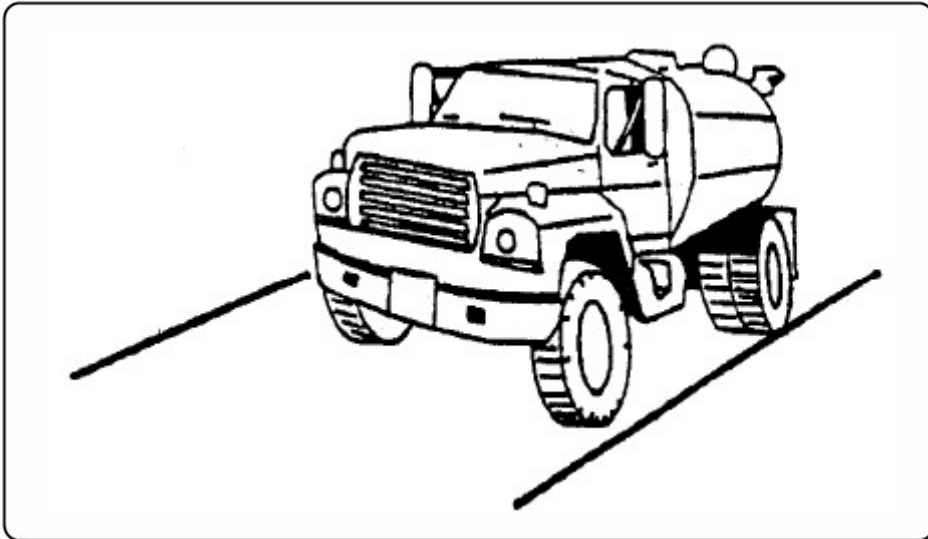

**DESCRIPTION:**

Dust control measures are used to stabilize soil from wind erosion, and reduce dust by construction activities.

**APPLICATION:**

- ▶ Dust control is useful in any process area, loading and unloading area, material handling areas, and transfer areas where dust is generated. Street sweeping is limited to areas that are paved.

**INSTALLATION/APPLICATION CRITERIA:**

- ▶ Mechanical dust collection systems are designed according to the size of dust particles and the amount of air to be processed. Manufacturers' recommendations should be followed for installation (as well as the design of the equipment).
- ▶ Two kinds of street sweepers are common: brush and vacuum. Vacuum sweepers are more efficient and work best when the area is dry.
- ▶ Mechanical equipment should be operated according to the manufacturers' recommendations and should be inspected regularly.

**LIMITATIONS:**

- ▶ Is generally more expensive than manual systems.
- ▶ May be impossible to maintain by plant personnel (the more elaborate equipment).
- ▶ Is labor and equipment intensive and may not be effective for all pollutants (street sweepers).

**MAINTENANCE:**

- ▶ If water sprayers are used, dust-contaminated waters should be collected and taken
- ▶ for treatment. Areas will probably need to be resprayed to keep dust from spreading.

**OBJECTIVES**

- Housekeeping Practices
- Contain Waste
- Minimize Disturbed Areas
- Stabilize Disturbed Areas
- Protect Slopes/Channels
- Control Site Perimeter
- Control Internal Erosion



**WEBER COUNTY**

**ENGINEERING DEPARTMENT**

2380 Washington Blvd., Suite 240  
Ogden, UT 84401  
(801) 399-8374

**TARGETED POLLUTANTS**

- Sediment
- Nutrients
- Toxic Materials
- Oil & Grease
- Floatable Materials
- Other Waste

- High Impact
- Medium Impact
- Low or Unknown Impact

**IMPLEMENTATION REQUIREMENTS**

- Capital Costs
- O&M Costs
- Maintenance
- Training

- High
- Medium
- Low



## DESCRIPTION:

A combination of wood fiber mulch, processed grass, or hay or straw mulch and a tacking agent. It is made into slurry, and then applied to bare slopes or other bare areas to provide temporary stabilization.

## APPLICATIONS:

- ▶ Small roadside slopes.
- ▶ Large, relatively flat areas.

## INSTALLATION/APPLICATION CRITERIA:

- ▶ Legume seeds should be pellet inoculated with the appropriate bacteria.
- ▶ The seed should not remain in the hydromulcher tank for more than 30 minutes.
- ▶ Wood fiber may be dyed to aid in uniform application.
- ▶ Slurry should be uniformly applied until an adequate coverage is achieved.
- ▶ The applicator should not be directed at one location for a long period of time; erosion will occur.

## LIMITATIONS:

- ▶ Will lose effectiveness after 1 year.
- ▶ Can use only on physically stable slopes (at natural angle of repose, or less).

## MAINTENANCE:

- ▶ Periodically inspect for damage caused by wind, water, or human disturbance.
- ▶ Promptly repair damaged areas.

## OBJECTIVES

- Housekeeping Practices
- Contain Waste
- Minimize Disturbed Areas
- Stabilize Disturbed Areas
- Protect Slopes/Channels
- Control Site Perimeter
- Control Internal Erosion



# WEBER COUNTY

## ENGINEERING DEPARTMENT

2380 Washington Blvd., Suite 240  
Ogden, UT 84401  
(801) 399-8374

## TARGETED POLLUTANTS

- Sediment
- Nutrients
- Toxic Materials
- Oil & Grease
- Floatable Materials
- Other Waste

- High Impact
- Medium Impact
- Low or Unknown Impact

## IMPLEMENTATION REQUIREMENTS

- Capital Costs
- O&M Costs
- Maintenance
- Training

- High
- Medium
- Low

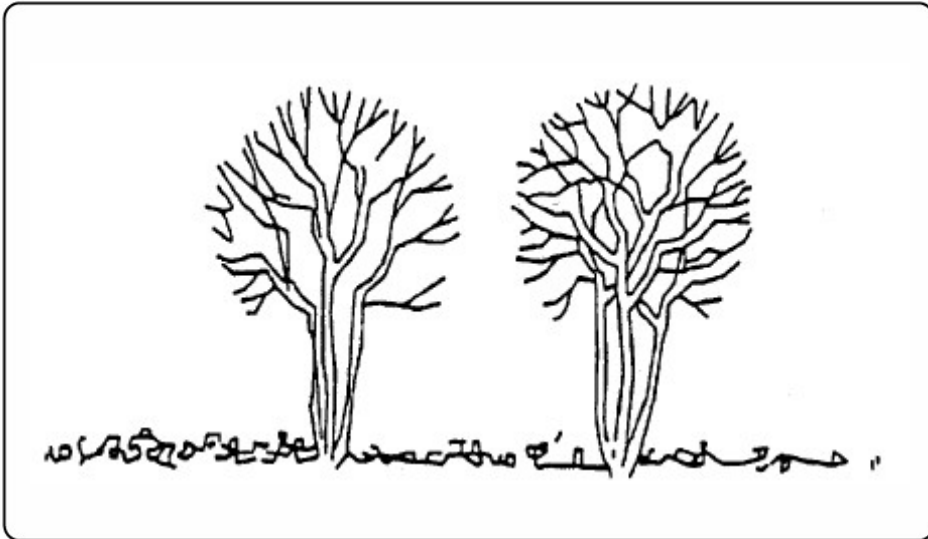

## DESCRIPTION:

Carefully planned preservation of existing vegetation minimizes the potential of removing or injuring existing trees, vines, shrubs and/or grasses that serve as erosion controls.

## APPLICATIONS:

- ▶ This technique is applicable to all types of sites. Areas where preserving vegetation can be particularly beneficial are floodplains, wetlands, stream banks, steep slopes, and other areas where erosion controls would be difficult to establish, install, or maintain.

## INSTALLATION/APPLICATION CRITERIA:

- ▶ Clearly mark, flag or fence vegetation or areas where vegetation should be preserved.
- ▶ Prepare landscaping plans which include as much existing vegetation as possible and state proper care during and after construction.
- ▶ Define and protect with berms, fencing, signs, etc. a setback area from vegetation to be preserved.
- ▶ Propose landscaping plans which do not include plant species that compete with the existing vegetation.
- ▶ Do not locate construction traffic routes, spoil piles, etc. where significant adverse impact on existing vegetation may occur.

## LIMITATIONS:

- ▶ Requires forward planning by the owner/developer, contractor and design staff.
- ▶ For sites with diverse topography, it is often difficult and expensive to save existing trees while grading the site satisfactorily for the planned development.
- ▶ May not be cost effective with high land costs.

## MAINTENANCE:

- ▶ Inspection and maintenance requirements for protection of vegetation are low.
- ▶ Maintenance of native trees or vegetation should conform to landscape plan specifications.

## OBJECTIVES

- Housekeeping Practices
- Contain Waste
- Minimize Disturbed Areas
- Stabilize Disturbed Areas
- Protect Slopes/Channels
- Control Site Perimeter
- Control Internal Erosion



# WEBER COUNTY

## ENGINEERING DEPARTMENT

2380 Washington Blvd., Suite 240  
Ogden, UT 84401  
(801) 399-8374

## TARGETED POLLUTANTS

- Sediment
- Nutrients
- Toxic Materials
- Oil & Grease
- Floatable Materials
- Other Waste

- High Impact
- Medium Impact
- Low or Unknown Impact

## IMPLEMENTATION REQUIREMENTS

- Capital Costs
- O&M Costs
- Maintenance
- Training

- High
- Medium
- Low



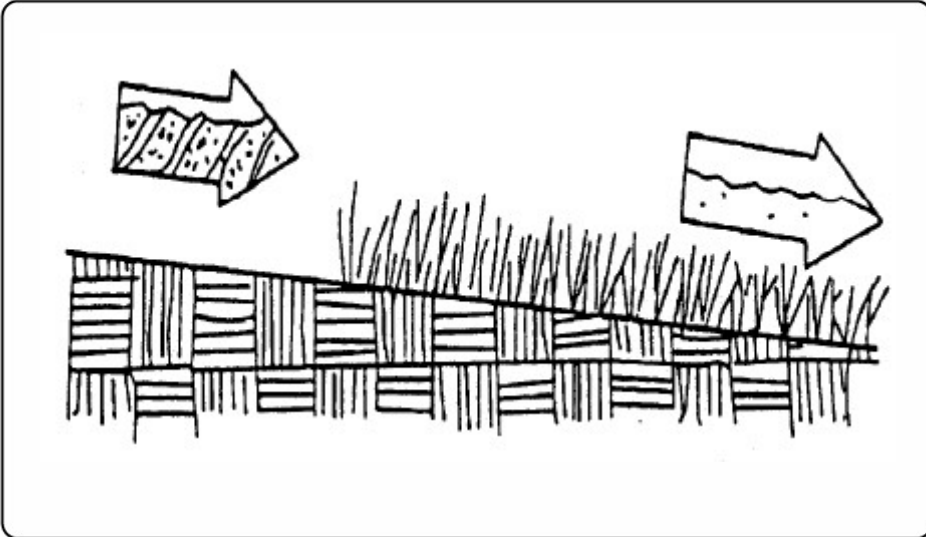

## DESCRIPTION:

- ▶ Seeding of grass and plantings of trees, shrubs, vines and ground covers provide long-term stabilization of soil. In some areas, with suitable climates, grasses can be planted for temporary stabilization.

## APPLICATION:

- ▶ Appropriate for site stabilization both during and after construction
- ▶ Any graded/cleared areas where construction activities have ceased.
- ▶ Open space cut and fill areas.
- ▶ Steep slopes, spoil piles, vegetated swales, landscape corridors, stream banks.

## INSTALLATION/APPLICATION CRITERIA:

Type of vegetation, site and seedbed preparation, planting time, fertilization and water requirements should be considered for each application. Grasses:

- ▶ Ground preparation: fertilize and mechanically stabilize the soil.
- ▶ Tolerant of short-term temperature extremes and waterlogged soil composition.
- ▶ Appropriate soil conditions: shallow soil base, good drainage, slope 2:1 or flatter.
- ▶ Mowing, irrigating, and fertilizing are vital for promoting vigorous grass growth.

Trees and Shrubs:

- ▶ Selection criteria: vigor, species, size, shape & wildlife food source.
- ▶ Soil conditions: select species appropriate for soil, drainage & acidity.
- ▶ Other factors: wind/exposure, temperature extremes, and irrigation needs.

Vines and Ground Covers:

- ▶ Ground preparation: lime and fertilizer preparation.
- ▶ Use proper seeding rates.
- ▶ Appropriate soil conditions: drainage, acidity and slopes.
- ▶ Generally avoid species requiring irrigation.

## LIMITATIONS:

- ▶ Permanent and temporary vegetation may not be appropriate in dry periods without irrigation.
- ▶ Fertilizer requirements may have potential to create stormwater pollution.

## MAINTENANCE:

- ▶ Shrubs and trees must be adequately watered and fertilized and if needed pruned.
- ▶ Grasses may need to be watered and mowed.

## OBJECTIVES

- Housekeeping Practices
- Contain Waste
- Minimize Disturbed Areas
- Stabilize Disturbed Areas
- Protect Slopes/Channels
- Control Site Perimeter
- Control Internal Erosion



# WEBER COUNTY

## ENGINEERING DEPARTMENT

2380 Washington Blvd., Suite 240  
Ogden, UT 84401  
(801) 399-8374

## TARGETED POLLUTANTS

- Sediment
- Nutrients
- Toxic Materials
- Oil & Grease
- Floatable Materials
- Other Waste

- High Impact
- Medium Impact
- Low or Unknown Impact

## IMPLEMENTATION REQUIREMENTS

- Capital Costs
- O&M Costs
- Maintenance
- Training

- High
- Medium
- Low

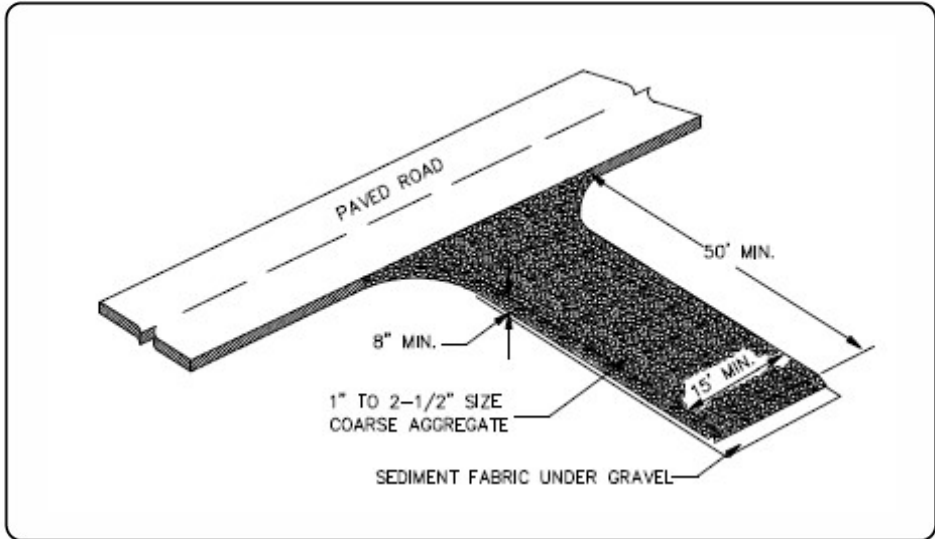

## DESCRIPTION:

A stabilized pad of crushed stone located where construction traffic enters or leaves the site from or to paved surface.

## APPLICATIONS:

- ▶ At any point of ingress or egress at a construction site where adjacent traveled way is paved. Generally applies to sites over 2 acres unless special conditions exist.

## INSTALLATION/APPLICATION CRITERIA:

- ▶ Clear and grub area and grade to provide maximum slope of 2%.
- ▶ Compact subgrade and place filter fabric if desired (recommended for entrances to remain for more than 3 months).
- ▶ Place coarse aggregate, 1 to 2-1/2 inches in size, to a minimum depth of 8 inches.

## LIMITATIONS:

- ▶ Requires periodic top dressing with additional stones.
- ▶ Should be used in conjunction with street sweeping on adjacent public right-of-way.

## MAINTENANCE:

- ▶ Inspect daily for loss of gravel or sediment buildup.
- ▶ Inspect adjacent roadway for sediment deposit and clean by sweeping or shoveling.
- ▶ Repair entrance and replace gravel as required to maintain control in good working condition.
- ▶ Expand stabilized area as required to accommodate traffic and prevent erosion at driveways.

## OBJECTIVES

- Housekeeping Practices
- Contain Waste
- Minimize Disturbed Areas
- Stabilize Disturbed Areas
- Protect Slopes/Channels
- Control Site Perimeter
- Control Internal Erosion



# WEBER COUNTY

## ENGINEERING DEPARTMENT

2380 Washington Blvd., Suite 240  
Ogden, UT 84401  
(801) 399-8374

## TARGETED POLLUTANTS

- Sediment
- Nutrients
- Toxic Materials
- Oil & Grease
- Floatable Materials
- Other Waste

- High Impact
- Medium Impact
- Low or Unknown Impact

## IMPLEMENTATION REQUIREMENTS

- Capital Costs
- O&M Costs
- Maintenance
- Training

- High
- Medium
- Low

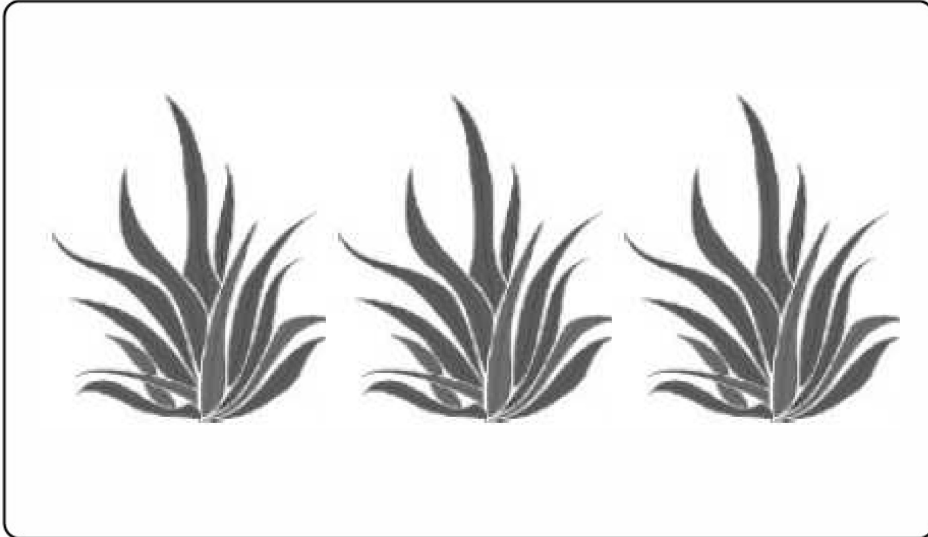

## DEFINITION:

- ▶ Temporary seeding - establishment of short term cover by application of rapidly germinating seed mix (alternatively hydroseeding may be utilized).
- ▶ Permanent seeding - establishment of final term cover by application of perennial seed mix (alternatively sod may be utilized).

## APPLICATION:

- ▶ Disturbed areas that are at final grade and which will not be disturbed by continuing activities on site. Also areas that are not at final grade but which will be left untouched in excess of one year.

## LIMITATIONS:

- ▶ Limited to areas that will not be subject to traffic or high usage.
- ▶ May require irrigation and fertilizer which creates potential for impacting runoff quality.
- ▶ May only be applied during appropriate planting season, temporary cover required until that time.

## INSTALLATION:

- ▶ Roughen soil to a depth of 2 inches. Add fertilizer, manure, topsoil as necessary.
- ▶ Evenly distribute seed using a commonly accepted method such as; breast seeding, drilling, hydroseeding.
- ▶ Use a seed mix appropriate for soil and location that will provide rapid germination and growth. Check with County for recommended mix and application rate.
- ▶ Cover area with mulch if required due to steep slopes or unsuitable weather conditions.

## MAINTENANCE:

- ▶ Provide irrigation as required to establish growth and to maintain plant cover through duration of project.
- ▶ Reseed as necessary to provide 75% coverage
- ▶ Remediate any areas damaged by erosion or traffic.
- ▶ When 75% coverage is achieved inspect monthly for damage and remediate as necessary.

## OBJECTIVES

- Housekeeping Practices
- Contain Waste
- Minimize Disturbed Areas
- Stabilize Disturbed Areas
- Protect Slopes/Channels
- Control Site Perimeter
- Control Internal Erosion



# WEBER COUNTY

## ENGINEERING DEPARTMENT

2380 Washington Blvd., Suite 240  
Ogden, UT 84401  
(801) 399-8374

## TARGETED POLLUTANTS

- Sediment
- Nutrients
- Toxic Materials
- Oil & Grease
- Floatable Materials
- Other Waste
  
- High Impact
- Medium Impact
- Low or Unknown Impact

## IMPLEMENTATION REQUIREMENTS

- Capital Costs
- O&M Costs
- Maintenance
- Training

- High
- Medium
- Low



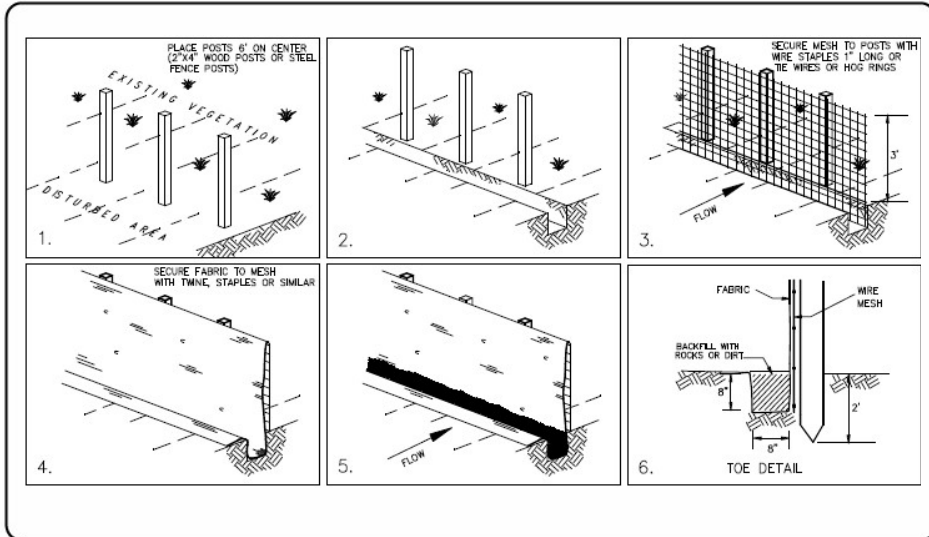

## DESCRIPTION:

- ▶ A temporary sediment barrier consisting of entrenched filter fabric stretched across and secured to supporting posts.

## APPLICATION:

- ▶ Perimeter control: place barrier at downgradient limits of disturbance
- ▶ Sediment barrier: place barrier at toe of slope or soil stockpile
- ▶ Protection of existing waterways: place barrier at top of stream bank
- ▶ Inlet protection: place fence surrounding catchbasins

## INSTALLATION/APPLICATION CRITERIA:

- ▶ Place posts 6 feet apart on center along contour (or use preassembled unit) and drive 2 feet minimum into ground. Excavate an anchor trench immediately upgradient of posts.
- ▶ Secure wire mesh (14 gage min. With 6 inch openings) to upslope side of posts. Attach with heavy duty 1 inch long wire staples, tie wires or hog rings.
- ▶ Cut fabric to required width, unroll along length of barrier and drape over barrier. Secure fabric to mesh with twine, staples, or similar, with trailing edge extending into anchor trench.
- ▶ Backfill trench over filter fabric to anchor.

## LIMITATIONS:

- ▶ Recommended maximum drainage area of 0.5 acre per 100 feet of fence
- ▶ Recommended maximum upgradient slope length of 150 feet
- ▶ Recommended maximum uphill grade of 2:1 (50%)
- ▶ Recommended maximum flow rate of 0.5 cfs
- ▶ Ponding should not be allowed behind fence

## MAINTENANCE:

- ▶ Inspect immediately after any rainfall and at least daily during prolonged rainfall.
- ▶ Look for runoff bypassing ends of barriers or undercutting barriers.
- ▶ Repair or replace damaged areas of the barrier and remove accumulated sediment.
- ▶ Reanchor fence as necessary to prevent shortcutting.
- ▶ Remove accumulated sediment when it reaches ½ the height of the fence.

## OBJECTIVES

- Housekeeping Practices
- Contain Waste
- Minimize Disturbed Areas
- Stabilize Disturbed Areas
- Protect Slopes/Channels
- Control Site Perimeter
- Control Internal Erosion



# WEBER COUNTY

## ENGINEERING DEPARTMENT

2380 Washington Blvd., Suite 240  
Ogden, UT 84401  
(801) 399-8374

## TARGETED POLLUTANTS

- Sediment
- Nutrients
- Toxic Materials
- Oil & Grease
- Floatable Materials
- Other Waste

- High Impact
- Medium Impact
- Low or Unknown Impact

## IMPLEMENTATION REQUIREMENTS

- Capital Costs
- O&M Costs
- Maintenance
- Training

- High
- Medium
- Low

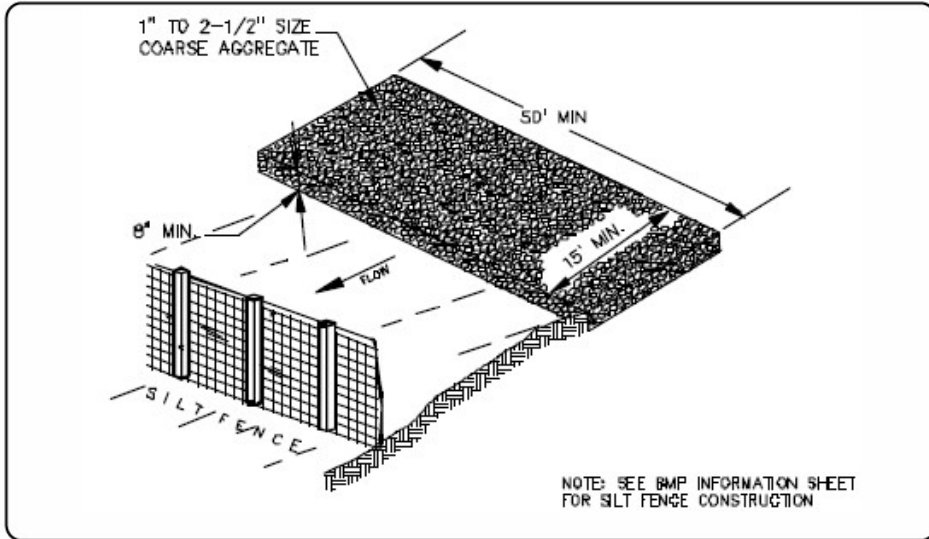

## DESCRIPTION:

A stabilized pad of crushed stone for general washing of equipment and construction vehicles.

## APPLICATION:

- ▶ At any site where regular washing of vehicles and equipment will occur. May also be used as a filling point for water trucks limiting erosion caused by overflow or spillage of water.

## INSTALLATION/APPLICATION CRITERIA:

- ▶ Clear and grub area and grade to provide maximum slope of 1%
- ▶ Compact subgrade and place filter fabric if desired (recommended for wash areas to remain in use for more than 3 months).
- ▶ Place coarse aggregate, 1 to 2-1/2 inches in size, to a minimum depth of 8-inches.
- ▶ Install silt fence downgradient (see silt fence BMP information sheet).

## LIMITATIONS:

- ▶ Cannot be utilized for washing equipment or vehicles that may cause contamination of runoff such as fertilizer equipment or concrete equipment. Solely used to control sediment in wash water.

## MAINTENANCE:

- ▶ Inspect daily for loss of gravel or sediment buildup.
- ▶ Inspect adjacent area for sediment deposit and install additional controls as necessary.
- ▶ Repair area and replace gravel as required to maintain control in good working condition.
- ▶ Expand stabilized area as required to accommodate activities.
- ▶ Maintain silt fence as outlined in specific silt fence BMP information sheet.

## OBJECTIVES

- Housekeeping Practices
- Contain Waste
- Minimize Disturbed Areas
- Stabilize Disturbed Areas
- Protect Slopes/Channels
- Control Site Perimeter
- Control Internal Erosion



# WEBER COUNTY

## ENGINEERING DEPARTMENT

2380 Washington Blvd., Suite 240  
Ogden, UT 84401  
(801) 399-8374

## TARGETED POLLUTANTS

- Sediment
- Nutrients
- Toxic Materials
- Oil & Grease
- Floatable Materials
- Other Waste

- High Impact
- Medium Impact
- Low or Unknown Impact

## IMPLEMENTATION REQUIREMENTS

- Capital Costs
- O&M Costs
- Maintenance
- Training

- High
- Medium
- Low

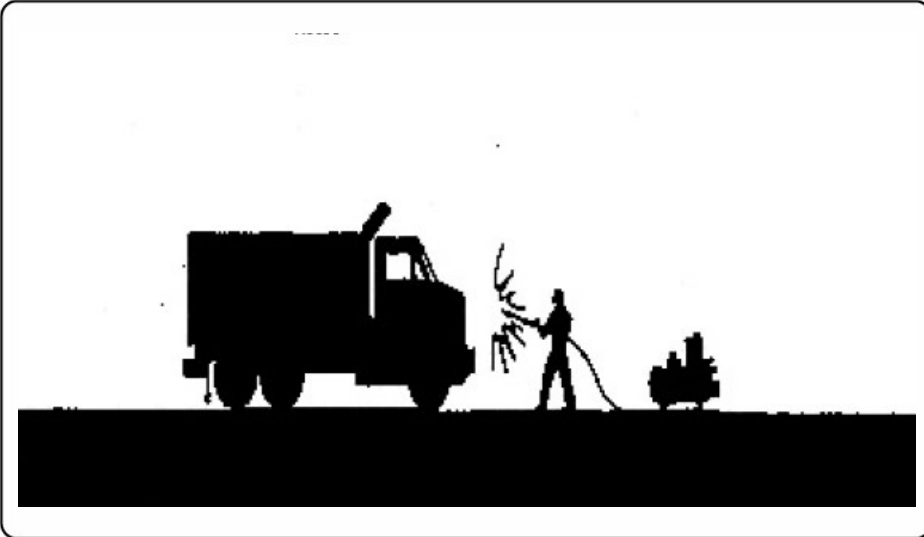

## DESCRIPTION:

Prevent or reduce the discharge of pollutants to stormwater from vehicle and equipment washing and steam cleaning by using off-site facilities, washing in designated, contained areas only, eliminating discharges to the storm drain by infiltrating or recycling the wash water, and training employees and subcontractors.

## APPROACH:

- ▶ Use off-site commercial washing and steam cleaning businesses as much as possible. Washing vehicles and equipment outdoors or in areas where wash water flows onto paved surfaces or into drainage pathways can pollute stormwater. If you wash a large number of vehicles or pieces of equipment, consider conducting this work at an off-site commercial business. These businesses are better equipped to handle and dispose of the wash waters properly. Performing this work off-site can also be economical by eliminating the need for a separate washing operation at your site.
- ▶ If washing must occur on-site, use designated, bermed wash areas to prevent wash water contact with stormwater, creeks, rivers, and other water bodies. The wash area can be sloped for wash water collection and subsequent infiltration into the ground.
- ▶ Use as little water as possible to avoid having to install erosion and sediment controls for the wash area. Use phosphate-free biodegradable soaps. Educate employees and subcontractors on pollution prevention measures. Do not permit steam cleaning on-site. Steam cleaning can generate significant pollutant concentrations.

## LIMITATIONS:

- ▶ Even phosphate-free, biodegradable soaps have been shown to be toxic to fish before the soap degrades.
- ▶ Sending vehicles/equipment off-site should be done in conjunction with Stabilized Construction Entrance. (See BMP in the Construction Section).
- ▶ The measures outlined in this fact sheet are insufficient to address all the environmental impacts and compliance issues related to steam cleaning.

## MAINTENANCE:

- ▶ Minimal, some berm repair may be necessary.

## OBJECTIVES

- Manufacturing
- Material Handling
- Vehicle Maintenance
- Construction
- Commercial Activities
- Roadways
- Waste Containment
- Housekeeping Practices



# WEBER COUNTY

## ENGINEERING DEPARTMENT

2380 Washington Blvd., Suite 240  
Ogden, UT 84401  
(801) 399-8374

## TARGETED POLLUTANTS

- Sediment
- Nutrients
- Heavy Metals
- Toxic Materials
- Oxygen Demanding Substance
- Oil & Grease
- Floatable Materials
- Bacteria & Viruses
- High Impact
- Medium Impact
- Low or Unknown Impact

## IMPLEMENTATION REQUIREMENTS

- Capital Costs
- O&M Costs
- Maintenance
- Training
- High
- Medium
- Low

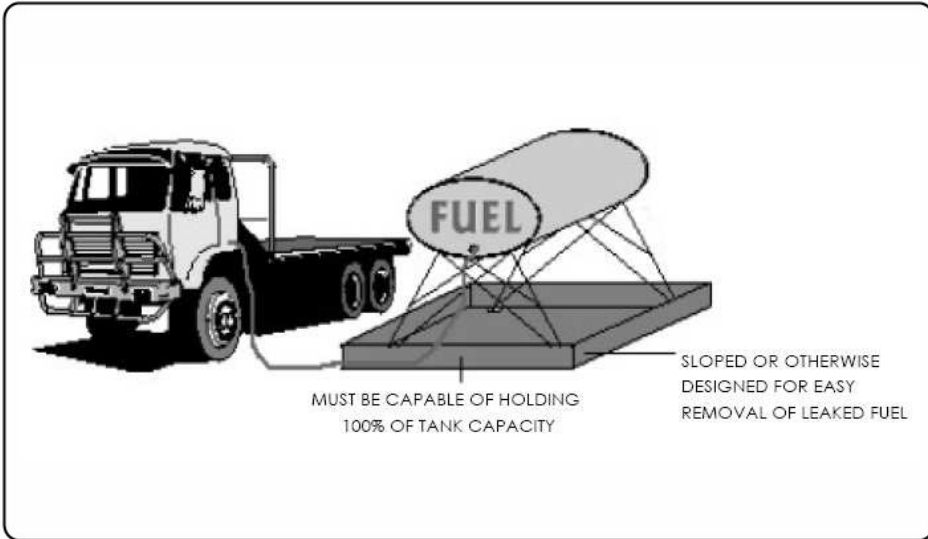

## OBJECTIVES

- Manufacturing
- Material Handling
- Vehicle Maintenance
- Construction
- Commercial Activities
- Roadways
- Waste Containment
- Housekeeping Practices



# WEBER COUNTY

## ENGINEERING DEPARTMENT

2380 Washington Blvd., Suite 240  
 Ogden, UT 84401  
 (801) 399-8374

## DESCRIPTION:

Prevent fuel spills and leaks, and reduce their impacts to stormwater by using off-site facilities, fueling in designated areas only, enclosing or covering stored fuel, implementing spill controls, and training employees and subcontractors.

## APPROACH:

- ▶ Use off-site fueling stations as much as possible. Fueling vehicles and equipment outdoors or in areas where fuel may spill/leak onto paved surfaces or into drainage pathways can pollute stormwater. If you fuel a large number of vehicles or pieces of equipment, consider using an off-site fueling station. These businesses are better equipped to handle fuel and spills properly. Performing this work off-site can also be economical by eliminating the need for a separate fueling area at your site.
- ▶ If fueling must occur on-site, use designated areas, located away from drainage courses, to prevent the runoff of stormwater and the runoff of spills.
- ▶ Discourage "topping-off" of fuel tanks.
- ▶ Always use secondary containment, such as a drain pan or drop cloth, when fueling to catch spills/leaks. Place a stockpile of spill cleanup materials where it will be readily accessible. Use adsorbent materials on small spills rather than hosing down or burying the spill. Remove the adsorbent materials promptly and dispose of properly.
- ▶ Carry out all federal and state requirements regarding stationary above ground storage tanks. Avoid mobile fueling of mobile construction equipment around the site; rather, transport the equipment to designated fueling areas. With the exception of tracked equipment such as bulldozers and perhaps forklifts, most vehicles should be able to travel to a designated area with little lost time. Train employees and subcontractors in proper fueling and cleanup procedures.

## LIMITATIONS:

- ▶ Sending vehicles/equipment off-site should be done in conjunction with Stabilized Construction Entrance (See BMP sheet in Construction section).

## MAINTENANCE:

- ▶ Keep ample supplies of spill cleanup materials on-site.
- ▶ Inspect fueling areas and storage tanks on a regular schedule.

## TARGETED POLLUTANTS

- Sediment
- Nutrients
- Heavy Metals
- Toxic Materials
- Oxygen Demanding Substance
- Oil & Grease
- Floatable Materials
- Bacteria & Viruses
- High Impact
- Medium Impact
- Low or Unknown Impact

## IMPLEMENTATION REQUIREMENTS

- Capital Costs
- O&M Costs
- Maintenance
- Training
- High
- Medium
- Low

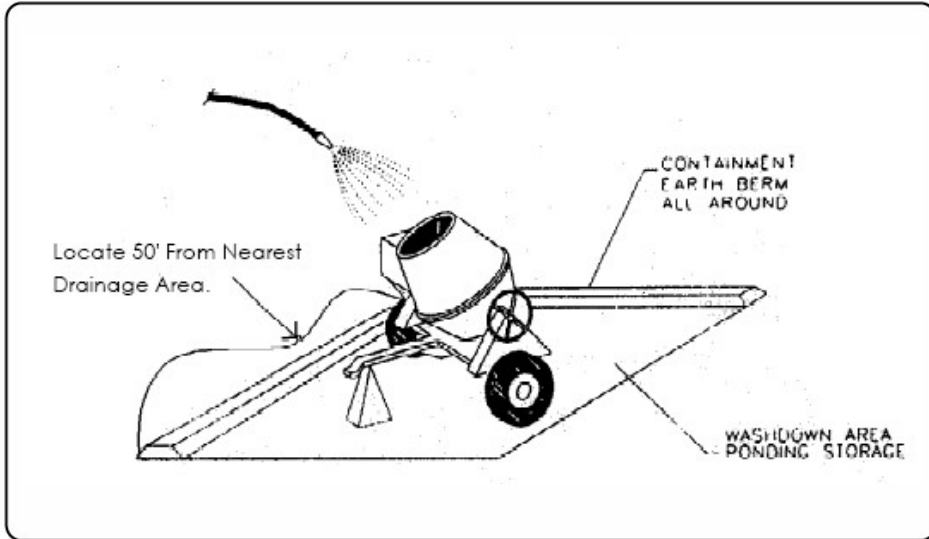

## DESCRIPTION:

Prevent or reduce the discharge of pollutants to storm water from concrete waste by conducting washout off-site, performing on-site washout in a designated area, and training employees and subcontractors.

## APPLICATIONS:

- ▶ This technique is applicable to all types of sites.

## INSTALLATION/APPLICATION CRITERIA:

- ▶ Store dry and wet materials under cover, away from drainage areas.
- ▶ Avoid mixing excess amounts of fresh concrete or cement on-site.
- ▶ Perform washout of concrete trucks off-site or in designated areas only.
- ▶ Do not wash out concrete trucks into storm drains, open ditches, streets, or streams.
- ▶ Do not allow excess concrete to be dumped on-site, except in designated areas.
- ▶ When washing concrete to remove fine particles and expose the aggregate, avoid creating runoff by draining the water within a bermed or level area. (See Earth Berm Barrier information sheet.)
- ▶ Train employees and subcontractors in proper concrete waste management.

## LIMITATIONS:

- ▶ Off-site washout of concrete wastes may not always be possible.

## MAINTENANCE:

- ▶ Inspect subcontractors to ensure that concrete wastes are being properly managed.
- ▶ If using a temporary pit, dispose hardened concrete on a regular basis.

## OBJECTIVES

- Housekeeping Practices
- Contain Waste
- Minimize Disturbed Areas
- Stabilize Disturbed Areas
- Protect Slopes/Channels
- Control Site Perimeter
- Control Internal Erosion



# WEBER COUNTY

## ENGINEERING DEPARTMENT

2380 Washington Blvd., Suite 240  
Ogden, UT 84401  
(801) 399-8374

## TARGETED POLLUTANTS

- Sediment
- Nutrients
- Toxic Materials
- Oil & Grease
- Floatable Materials
- Other Construction Waste

- High Impact
- Medium Impact
- Low or Unknown Impact

## IMPLEMENTATION REQUIREMENTS

- Capital Costs
- O&M Costs
- Maintenance
- Training

- High
- Medium
- Low





**DESCRIPTION:**

Prevent or reduce the discharge of pollutants to stormwater from hazardous waste through proper material use, waste disposal, and training of employees and subcontractors.

**APPLICATION:**

Many of the chemicals used on-site can be hazardous materials which become hazardous waste upon disposal. These wastes may include:

- ▶ Paints and solvents; petroleum products such as oils; fuels and greases; herbicides and pesticides; acids for cleaning masonry; and concrete curing compounds.

In addition, sites with existing structures may contain wastes which must be disposed of in accordance with federal, state and local regulations, including:

- ▶ Sandblasting grit mixed with lead, cadmium or chromium based paints, asbestos, and PCBs.

**INSTALLATION/APPLICATION CRITERIA:**

The following steps will help reduce stormwater pollution from hazardous wastes:

- ▶ Use the entire product before disposing of the container.
- ▶ Do not remove the original product label; it contains important safety and disposal information.
- ▶ Do not over-apply herbicides and pesticides. Prepare only the amount needed. Follow the recommended usage instructions. Over-application is expensive and environmentally harmful. Apply surface dressings in several smaller applications, as opposed to one large application, to allow time for infiltration and to avoid excess material being carried off-site by runoff. Do not apply these chemicals just before it rains. People applying pesticides must be certified in accordance with federal and state regulations.

**LIMITATIONS:**

- ▶ Hazardous waste that cannot be reused or recycled must be disposed of by a licensed hazardous waste collector.

**MAINTENANCE:**

- ▶ Inspect hazardous waste receptacles and areas regularly.
- ▶ Arrange for regular hazardous waste collection.

**OBJECTIVES**

- New Development
- Residential
- Commercial Activities
- Industrial Activities
- Municipal Facilities
- Illegal Discharges



**WEBER COUNTY**

**ENGINEERING DEPARTMENT**

2380 Washington Blvd., Suite 240  
Ogden, UT 84401  
(801) 399-8374

**TARGETED POLLUTANTS**

- Sediment
- Nutrients
- Heavy Metals
- Toxic Materials
- Oxygen Demanding Substance
- Oil & Grease
- Floatable Materials
- Bacteria & Viruses
- High Impact
- Medium Impact
- Low or Unknown Impact

**IMPLEMENTATION REQUIREMENTS**

- Capital Costs
- O&M Costs
- Regulatory
- Training
- Staffing
- Administrative
- High
- Medium
- Low

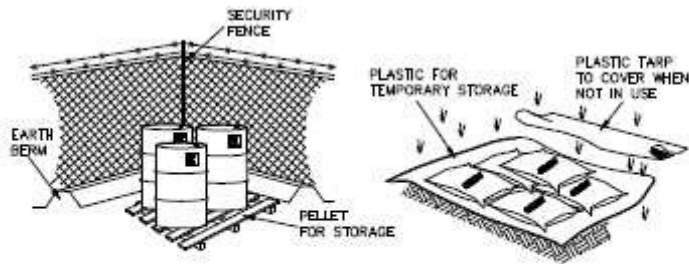

- ▶ CONTROLLED STORAGE LOCATION
- ▶ BERMED PERIMETER IMPOUNDMENT
- ▶ STORAGE OFF GROUND
- ▶ COVER WHEN NOT IN USE

## DESCRIPTION:

Controlled storage of on-site materials.

## APPLICATION:

- ▶ Storage of hazardous, toxic, and all chemical substances.
- ▶ Any construction site with outside storage of materials.

## INSTALLATION/APPLICATION CRITERIA:

- ▶ Designate a secured area with limited access as the storage location. Ensure no waterways or drainage paths are nearby.
- ▶ Construct compacted earthen berm (See Earth Berm Barrier Information Sheet), or similar perimeter containment around storage location for impoundment in the case of spills.
- ▶ Ensure all on-site personnel utilize designated storage area. Do not store excessive amounts of material that will not be utilized on site.
- ▶ For active use of materials away from the storage area ensure materials are not set directly on the ground and are covered when not in use. Protect storm drainage during use.

## LIMITATIONS:

- ▶ Does not prevent contamination due to mishandling of products.
- ▶ Spill Prevention and Response Plan still required.
- ▶ Only effective if materials are actively stored in controlled location.

## MAINTENANCE:

- ▶ Inspect daily and repair any damage to perimeter impoundment or security fencing.
- ▶ Check materials are being correctly stored (i.e. standing upright, in labeled containers, tightly capped) and that no materials are being stored away from the designated location.

## OBJECTIVES

- Housekeeping Practices
- Contain Waste
- Minimize Disturbed Areas
- Stabilize Disturbed Areas
- Protect Slopes/Channels
- Control Site Perimeter
- Control Internal Erosion



# WEBER COUNTY

## ENGINEERING DEPARTMENT

2380 Washington Blvd., Suite 240  
Ogden, UT 84401  
(801) 399-8374

## TARGETED POLLUTANTS

- Sediment
- Nutrients
- Toxic Materials
- Oil & Grease
- Floatable Materials
- Other Construction Waste

- High Impact
- Medium Impact
- Low or Unknown Impact

## IMPLEMENTATION REQUIREMENTS

- Capital Costs
- O&M Costs
- Maintenance
- Training

- High
- Medium
- Low

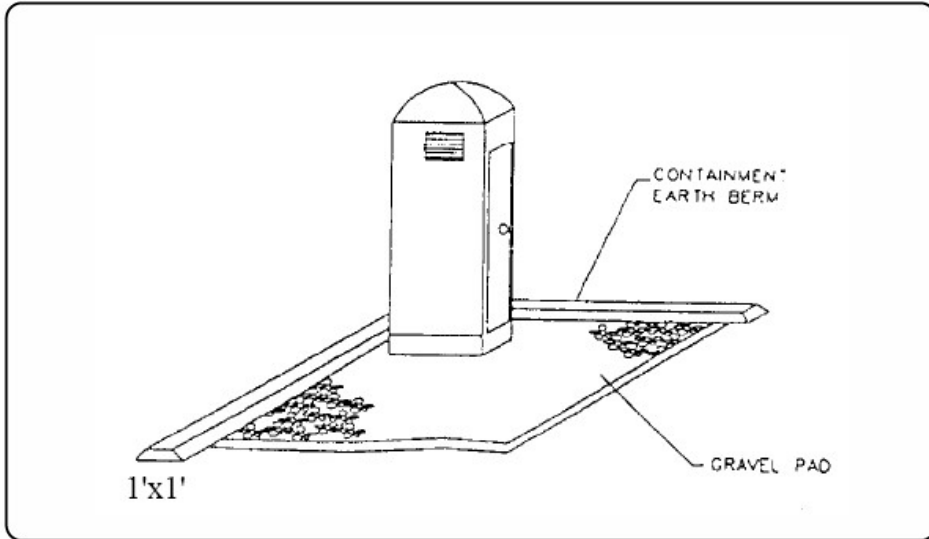

**DESCRIPTION:**

Temporary on-site sanitary facilities for construction personnel.

**APPLICATION:**

- ▶ All sites with no permanent sanitary facilities or where permanent facility is too far from activities.

**INSTALLATION/APPLICATION CRITERIA:**

- ▶ Locate portable toilets in convenient locations throughout the site.
- ▶ Prepare level, gravel surface and provide clear access to the toilets for servicing and for on-site personnel.
- ▶ Construct earth berm perimeter (See Earth Berm Barrier Information Sheet), control for spill/protection leak.

**LIMITATIONS:**

No limitations.

**MAINTENANCE:**

- ▶ Portable toilets should be maintained in good working order by licensed service with daily observation for leak detection.
- ▶ Regular waste collection should be arranged with licensed service.
- ▶ All waste should be deposited in sanitary sewer system for treatment with appropriate agency approval.

**OBJECTIVES**

- Housekeeping Practices
- Contain Waste
- Minimize Disturbed Areas
- Stabilize Disturbed Areas
- Protect Slopes/Channels
- Control Site Perimeter
- Control Internal Erosion



**WEBER COUNTY**

**ENGINEERING DEPARTMENT**

2380 Washington Blvd., Suite 240  
Ogden, UT 84401  
(801) 399-8374

**TARGETED POLLUTANTS**

- Sediment
- Nutrients
- Toxic Materials
- Oil & Grease
- Floatable Materials
- Other Construction Waste

- High Impact
- Medium Impact
- Low or Unknown Impact

**IMPLEMENTATION REQUIREMENTS**

- Capital Costs
- O&M Costs
- Maintenance
- Training

- High
- Medium
- Low



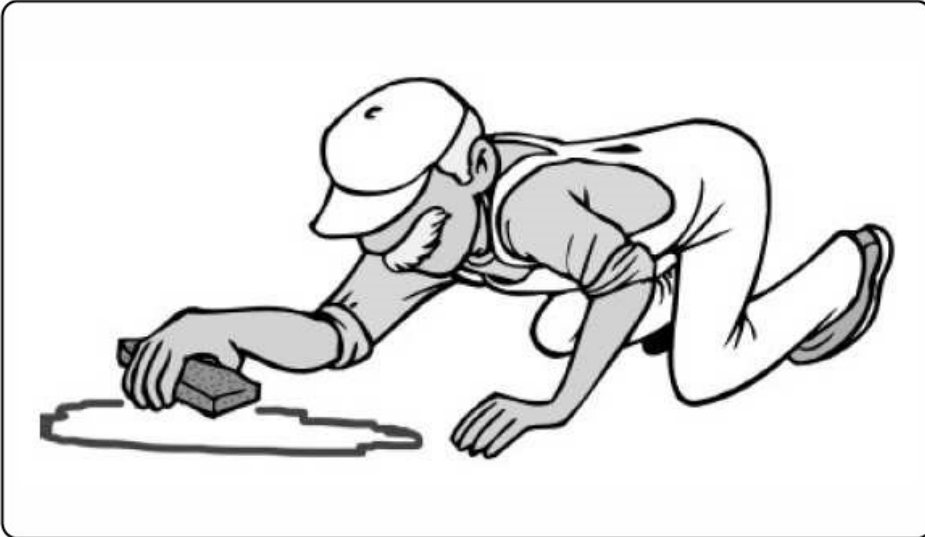

### DESCRIPTION:

Practices to clean-up leakage/spillage of on-site materials that may be harmful to receiving waters.

### APPLICATION:

- ▶ All sites

### GENERAL:

- ▶ Store controlled materials within a storage area.
- ▶ Educate personnel on prevention and clean-up techniques.
- ▶ Designate an Emergency Coordinator responsible for employing preventative practices and for providing spill response.
- ▶ Maintain a supply of clean-up equipment on-site and post a list of local response agencies with phone numbers.

### METHODS:

- ▶ Clean-up spills/leaks immediately and remediate cause.
- ▶ Use as little water as possible. NEVER HOSE DOWN OR BURY SPILL CONTAMINATED MATERIAL.
- ▶ Use rags or absorbent material for clean-up. Excavate contaminated soils. Dispose of clean-up material and soil as hazardous waste.
- ▶ Document all spills with date, location, substance, volume, actions taken and other pertinent data.
- ▶ Contact local Fire Department and State Division of Environmental Response and Remediation (Phone #536-4100) for any spill of reportable quantity.

### OBJECTIVES

- Housekeeping Practices
- Contain Waste
- Minimize Disturbed Areas
- Stabilize Disturbed Areas
- Protect Slopes/Channels
- Control Site Perimeter
- Control Internal Erosion



## WEBER COUNTY

### ENGINEERING DEPARTMENT

2380 Washington Blvd., Suite 240  
Ogden, UT 84401  
(801) 399-8374

### TARGETED POLLUTANTS

- Sediment
- Nutrients
- Toxic Materials
- Oil & Grease
- Floatable Materials
- Other Construction Waste
  
- High Impact
- Medium Impact
- Low or Unknown Impact

### IMPLEMENTATION REQUIREMENTS

- Capital Costs
- O&M Costs
- Maintenance
- Training
  
- High
- Medium
- Low

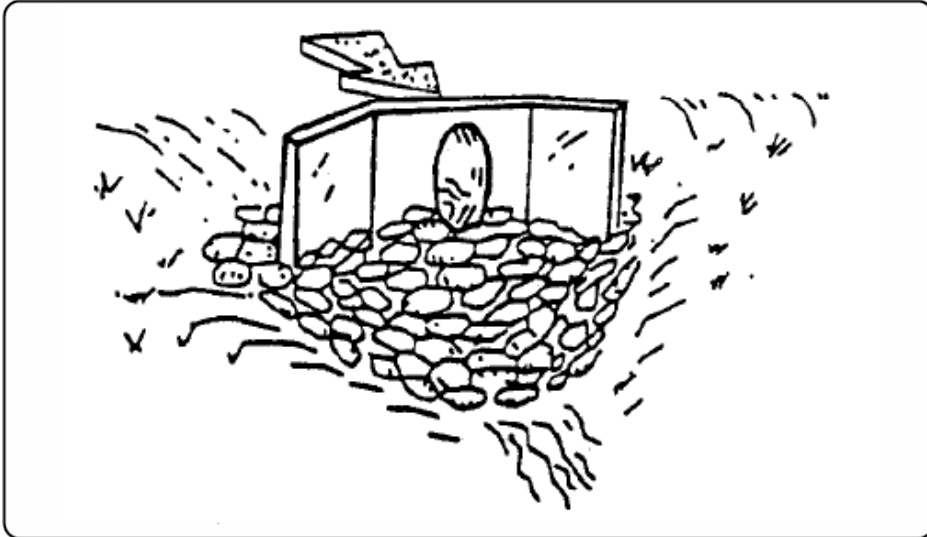

## DESCRIPTION:

A rock outlet protection is a physical device composed of rock, grouted riprap, or concrete rubble which is placed at the outlet of a pipe to prevent scour of the soil caused by high pipe flow velocities, and to absorb flow energy to produce non-erosive velocities.

## APPLICATIONS:

- ▶ Wherever discharge velocities and energies at the outlets of culverts, conduits, or channels are sufficient to erode the next downstream reach.
- ▶ Rock outlet protection is best suited for temporary use during construction because it is usually less expensive and easier to install than concrete aprons or an energy dissipator.
- ▶ A sediment trap below the pipe outlet is recommended if runoff is sediment laden.
- ▶ Permanent rock riprap protection should be designed and sized by the engineer as part of the culvert, conduit or channel design.
- ▶ Grouted riprap should be avoided in areas of freeze and thaw because the grout will break up.

## INSTALLATION/APPLICATION CRITERIA:

- ▶ Rock outlet protection is effective when the rock is sized and placed properly. When this is accomplished, rock outlets do much to limit erosion at pipe outlets. Rock size should be increased for high velocity flows. Best results are obtained when sound, durable, angular rock is used.

## LIMITATIONS:

- ▶ Large storms often wash away the rock outlet protection and leave the area susceptible to erosion.
- ▶ Sediment captured by the rock outlet protection may be difficult to remove without removing the rock.
- ▶ Outlet protection may negatively impact the channel habitat.

## MAINTENANCE:

- ▶ Inspect after each significant rain for erosion and/or disruption of the rock, and repair immediately.
- ▶ Grouted or wire-tied rock riprap can minimize maintenance requirements.

## OBJECTIVES

- Housekeeping Practices
- Contain Waste
- Minimize Disturbed Areas
- Stabilize Disturbed Areas
- Protect Slopes/Channels
- Control Site Perimeter
- Control Internal Erosion



# WEBER COUNTY

## ENGINEERING DEPARTMENT

2380 Washington Blvd., Suite 240  
Ogden, UT 84401  
(801) 399-8374

## TARGETED POLLUTANTS

- Sediment
- Nutrients
- Toxic Materials
- Oil & Grease
- Floatable Materials
- Other Waste

- High Impact
- Medium Impact
- Low or Unknown Impact

## IMPLEMENTATION REQUIREMENTS

- Capital Costs
- O&M Costs
- Maintenance
- Training

- High
- Medium
- Low

## **Appendix I: Construction General Permit**

If all storm water team members access the CGP via the internet while on site the following link to access the Construction General Permit is sufficient:

<http://construction.stormwater.utah.gov>

Otherwise, include a printed out copy of the Construction General Permit in this appendix.