

DATE: 12/21/12 TIME: 12:05:32 PM DRAWING NAME: ST0106.DWG
 SERVER: NONE PLOT SETUP: LAYOUT1
 NO. SURVEY/ROAD/PHASE: 1/SURVEY/PLATS/PRELIMINARY/ROAD/DEDICATION/PH-1 PROJ. NO.: 000

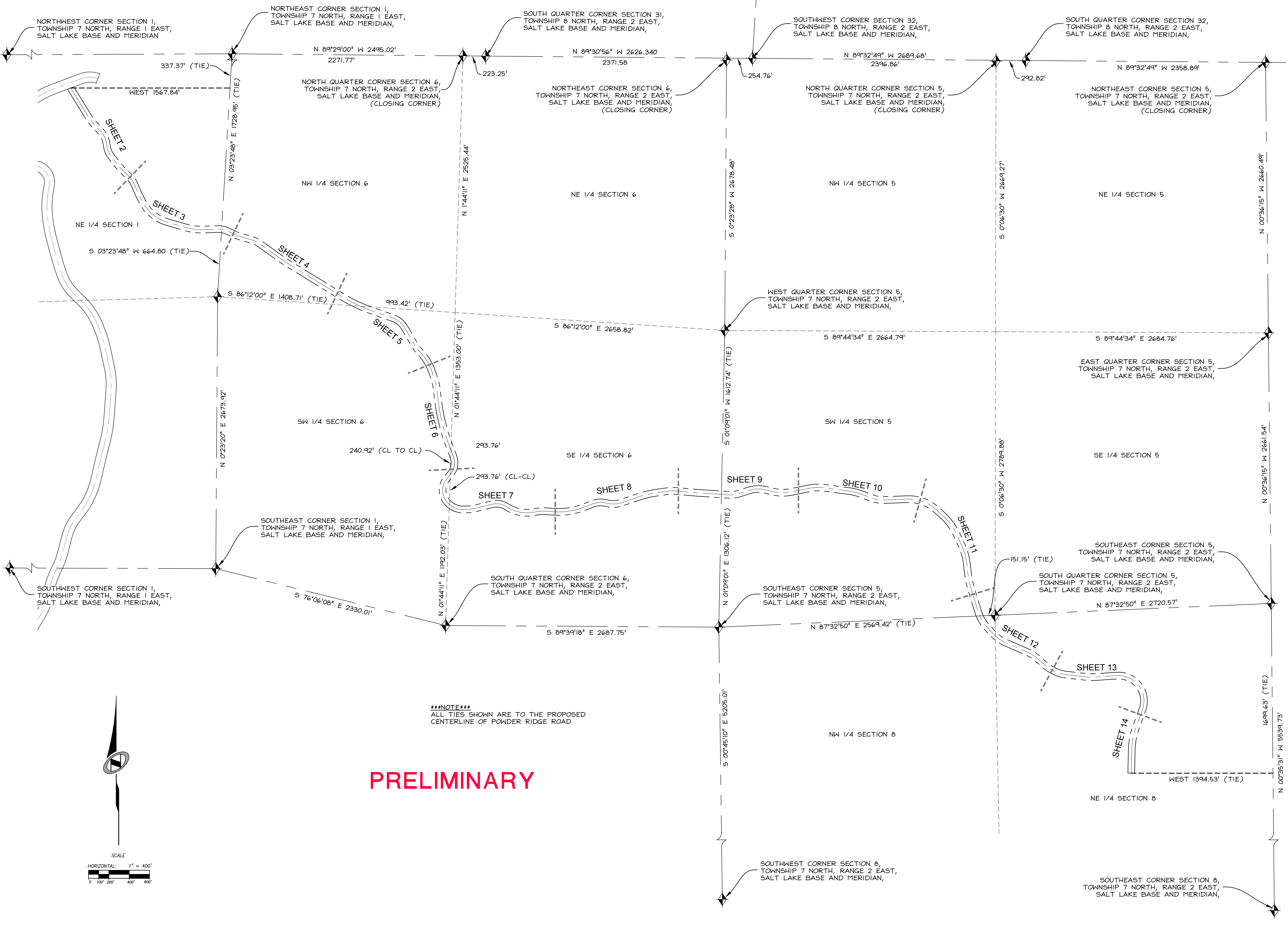

PRELIMINARY

NO.	DATE	REVISIONS

SUMMIT AT POWDER MOUNTAIN PH-1
POWDER RIDGE ROAD
PRELIMINARY DEDICATION PLAT

DATE SUBMITTED: 12/21/2012

PREPARED FOR: SUMMIT GROUP, LLC.

MURRAY, UT 84107
 WWW.NV5.COM

NV5
 BEYOND ENGINEERING

5217 SOUTH STATE STREET, SUITE 300
 801743.8800 TEL. 801743.0800 FAX

SHEET NUMBER	1
OF	14 SHEETS
SCALE	VERTICAL: 1"= N/A HORIZONTAL: 1"= 400'
JOB NUMBER	SLB0793

The engineer preparing these plans will not be responsible for, or liable for, unauthorized changes to or uses of these plans, and must be approved by the preparer of these plans.

DATE: 12/21/12 TIME: 12:05:51 PM DRAWING NAME: S102.DWG
 SERVER: NONE PLOT SETUP: LAYOUT: LAYOUT1
 NO. SUBPLOTS: 1 PHASE: 1 SURVEY PLATS: PRELIMINARY (R/S) (C/S) (M/S) PROJ. NO.: ###

ALLEN
 XREFS:

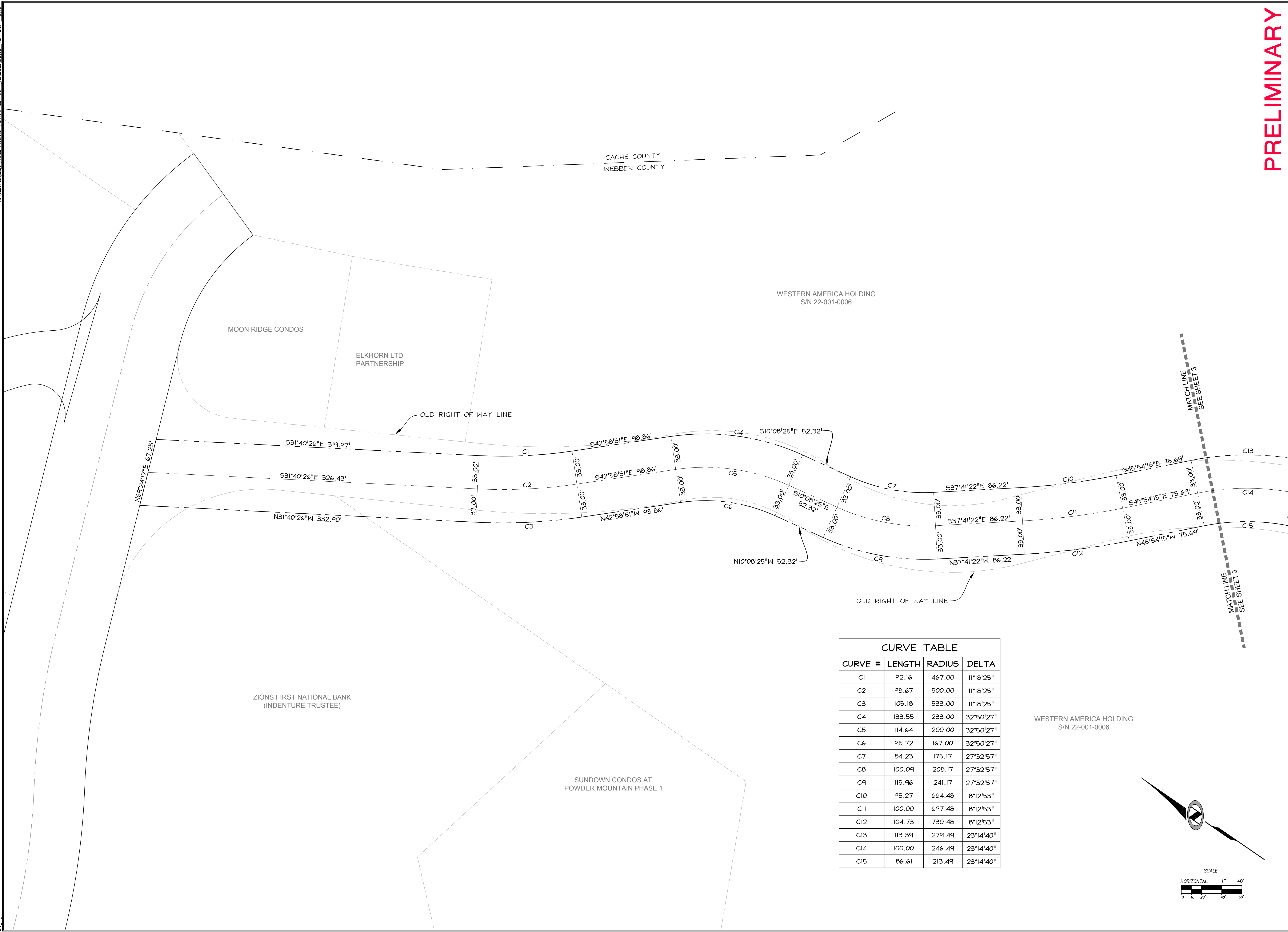

CURVE TABLE			
CURVE #	LENGTH	RADIUS	DELTA
C1	92.16	467.00	11°18'25"
C2	98.67	500.00	11°18'25"
C3	105.18	533.00	11°18'25"
C4	133.55	233.00	32°50'27"
C5	114.64	200.00	32°50'27"
C6	95.72	167.00	32°50'27"
C7	84.23	175.17	27°32'57"
C8	100.09	208.17	27°32'57"
C9	115.96	241.17	27°32'57"
C10	95.27	664.48	8°12'53"
C11	100.00	697.48	8°12'53"
C12	104.73	730.48	8°12'53"
C13	113.39	279.49	23°14'40"
C14	100.00	246.49	23°14'40"
C15	86.61	213.49	23°14'40"

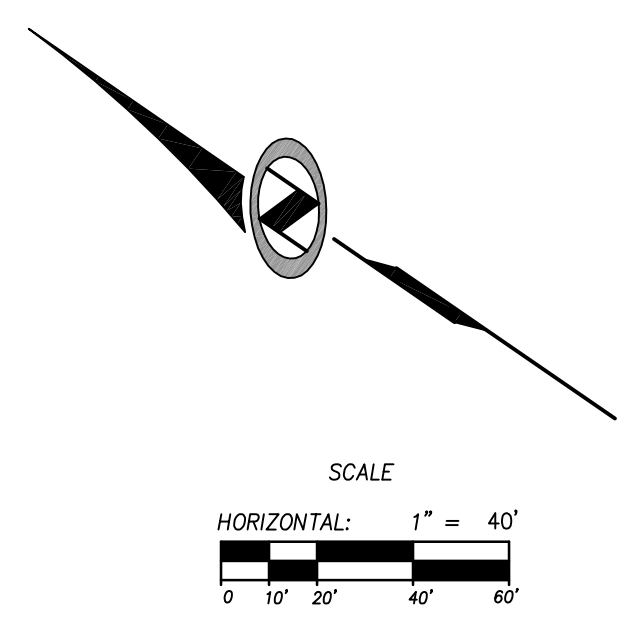

PRELIMINARY

NO.	BY	DATE	REVISIONS

SUMMIT AT POWDER MOUNTAIN PH-1
POWDER RIDGE ROAD
PRELIMINARY DEDICATION PLAT

DATE SUBMITTED: 12/21/2012

NV5
 BEYOND ENGINEERING

MURRAY, UT 84077
 WWW.NV5.COM

5217 SOUTH STATE STREET, SUITE 300
 801743.8800 TEL. 801743.0800 FAX

PREPARED FOR: SUMMIT GROUP, LLC.

SHEET NUMBER	2
OF	14 SHEETS
SCALE	VERTICAL: 1" = N/A HORIZONTAL: 1" = 40'
JOB NUMBER	SLB0793

CAUTION
 The engineer preparing these plans will not be responsible for, or liable for, unauthorized changes to or uses of these plans. The engineer's liability is limited to the design and must be approved by the preparer of these plans.

DATE: 12/21/12 TIME: 12:05:10 PM DRAWING NAME: S:\03.DWG
 SERVER: NONE PAGE SETUP: LAYOUT: 1
 N:\SUB\03\ROAD\PHASE 1\SURVEY\PLANS\PRELIMINARY\ROAD\SLB0793.DWG PROJ. WDR: ###

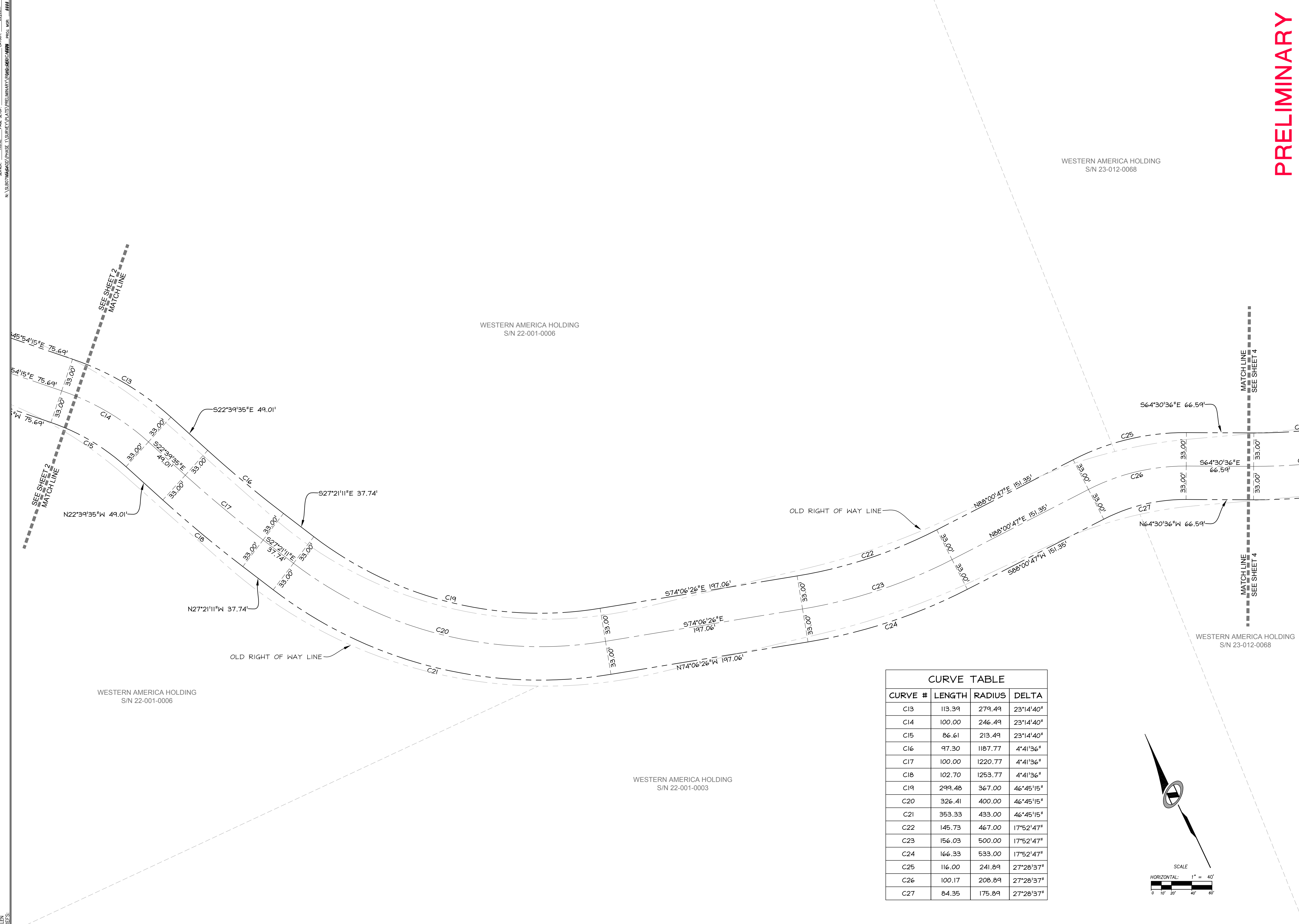

CURVE TABLE			
CURVE #	LENGTH	RADIUS	DELTA
C13	113.39	279.49	23°14'40"
C14	100.00	246.49	23°14'40"
C15	86.61	213.49	23°14'40"
C16	97.30	1187.77	4°41'36"
C17	100.00	1220.77	4°41'36"
C18	102.70	1253.77	4°41'36"
C19	299.48	367.00	46°45'15"
C20	326.41	400.00	46°45'15"
C21	353.33	433.00	46°45'15"
C22	145.73	467.00	17°52'47"
C23	156.03	500.00	17°52'47"
C24	166.33	533.00	17°52'47"
C25	116.00	241.89	27°28'37"
C26	100.17	208.89	27°28'37"
C27	84.35	175.89	27°28'37"

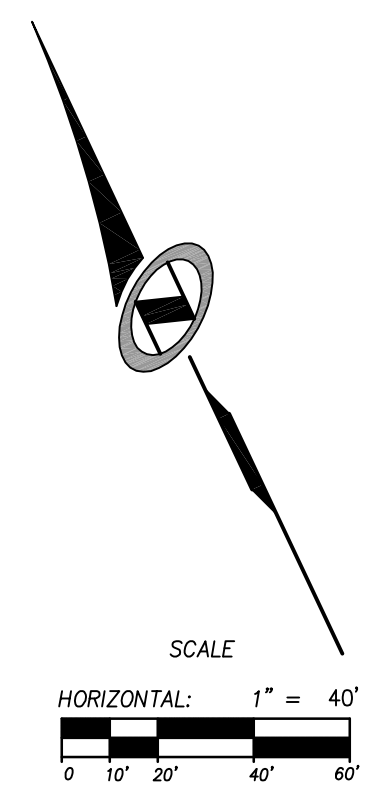

WESTERN AMERICA HOLDING
S/N 23-012-0068

WESTERN AMERICA HOLDING
S/N 22-001-0006

WESTERN AMERICA HOLDING
S/N 22-001-0006

WESTERN AMERICA HOLDING
S/N 22-001-0003

WESTERN AMERICA HOLDING
S/N 23-012-0068

PRELIMINARY

SUMMIT AT POWDER MOUNTAIN PH-1
POWDER RIDGE ROAD
PRELIMINARY DEDICATION PLAN

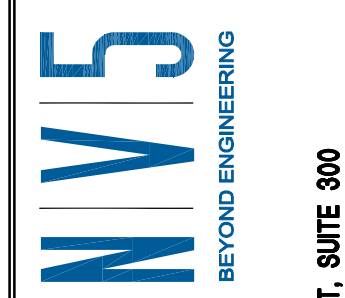

MURRAY, UT 84007
WWW.NVS.COM

527 SOUTH STATE STREET, SUITE 300
801743800 TEL. 8017430800 FAX

SHEET NUMBER	3
OF	14 SHEETS
SCALE	HORIZONTAL: 1" = 40' VERTICAL: 1" = 40'
JOB NUMBER	SLB0793

DATE SUBMITTED: 12/21/2012

PREPARED FOR: SUMMIT GROUP, LLC.

NO.	BY	DATE	REVISIONS

CAUTION
 The engineer preparing these plans will not be responsible for, or liable for, unauthorized changes to or uses of these plans. Any such changes or uses must be approved by the preparer of these plans.

ALLEN XREFS:

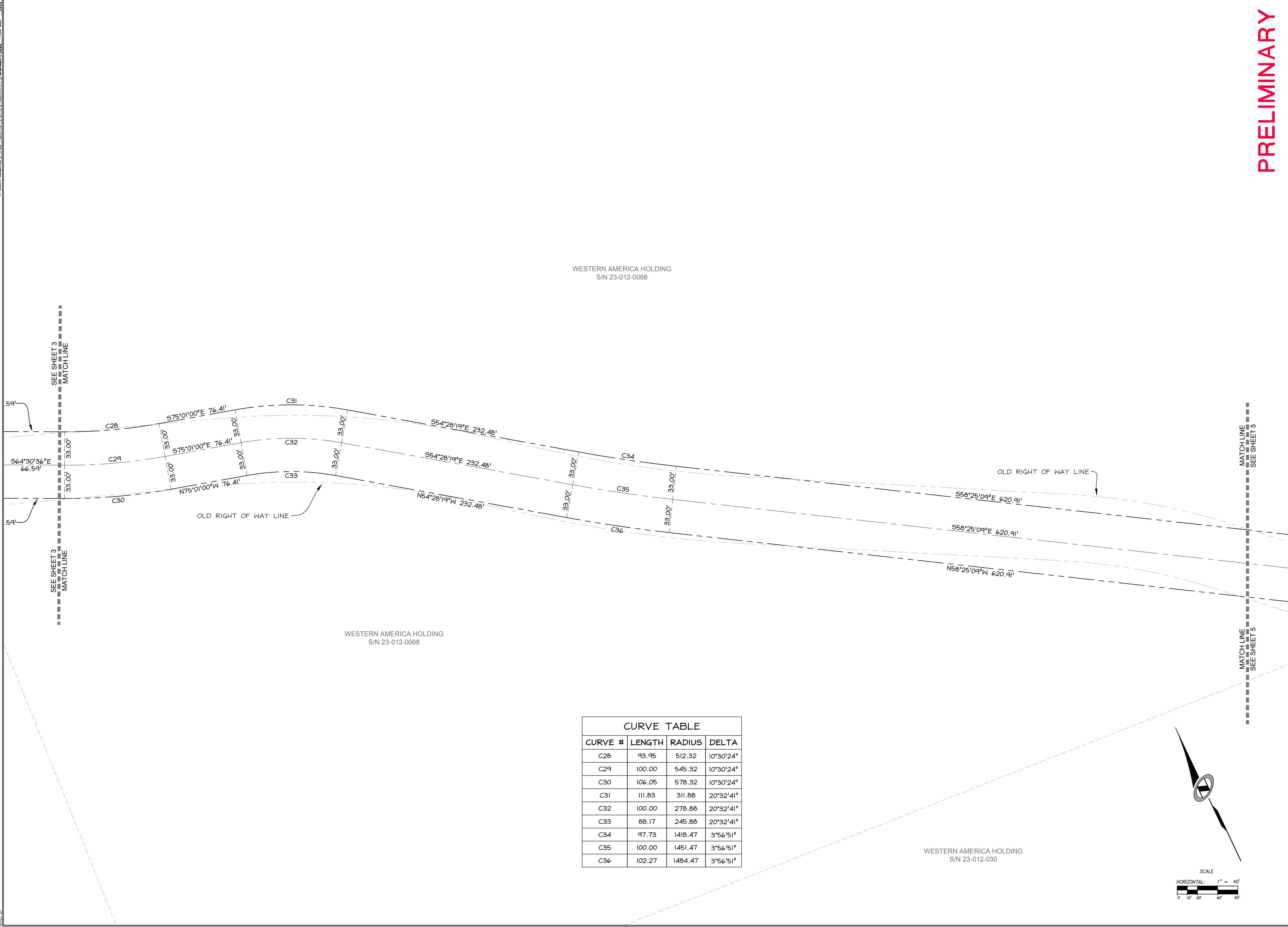

WESTERN AMERICA HOLDING
 S/N 23-012-0068

WESTERN AMERICA HOLDING
 S/N 23-012-0068

WESTERN AMERICA HOLDING
 S/N 23-012-030

CURVE TABLE			
CURVE #	LENGTH	RADIUS	DELTA
C28	93.95	512.32	10°30'24"
C29	100.00	545.32	10°30'24"
C30	106.05	578.32	10°30'24"
C31	111.83	311.88	20°32'41"
C32	100.00	278.88	20°32'41"
C33	88.17	245.88	20°32'41"
C34	97.73	1418.47	3°56'51"
C35	100.00	1451.47	3°56'51"
C36	102.27	1484.47	3°56'51"

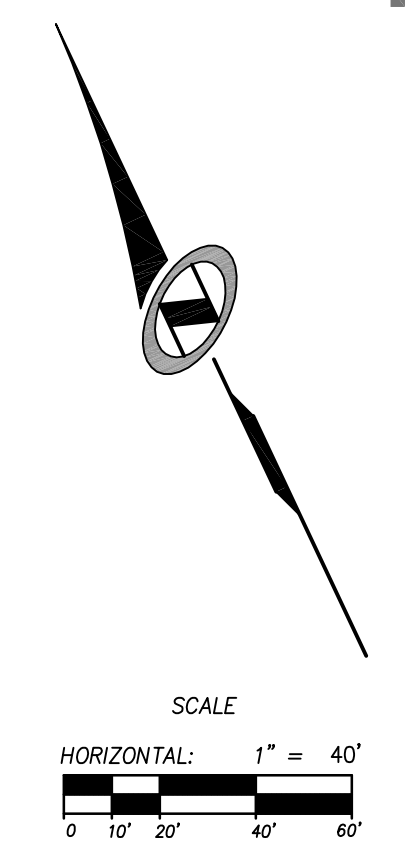

PRELIMINARY

SUMMIT AT POWDER MOUNTAIN PH-1
POWDER RIDGE ROAD
PRELIMINARY DEDICATION PLAT

NV5
 BEYOND ENGINEERING

5217 SOUTH STATE STREET, SUITE 300
 801743-8800 TEL. 801743-0800 FAX

MURRAY, UT 84007
 WWW.NV5.COM

SHEET NUMBER	4
OF	14 SHEETS
SCALE	HORIZONTAL: 1" = N/A VERTICAL: 1" = 40'
JOB NUMBER	SLB0793

DATE SUBMITTED: 12/21/2012

PREPARED FOR: SUMMIT GROUP, LLC.

CAUTION
 The engineer preparing these plans will not be responsible for, or liable for, unauthorized changes to or uses of these plans. Any such changes or uses must be approved by the preparer of these plans.

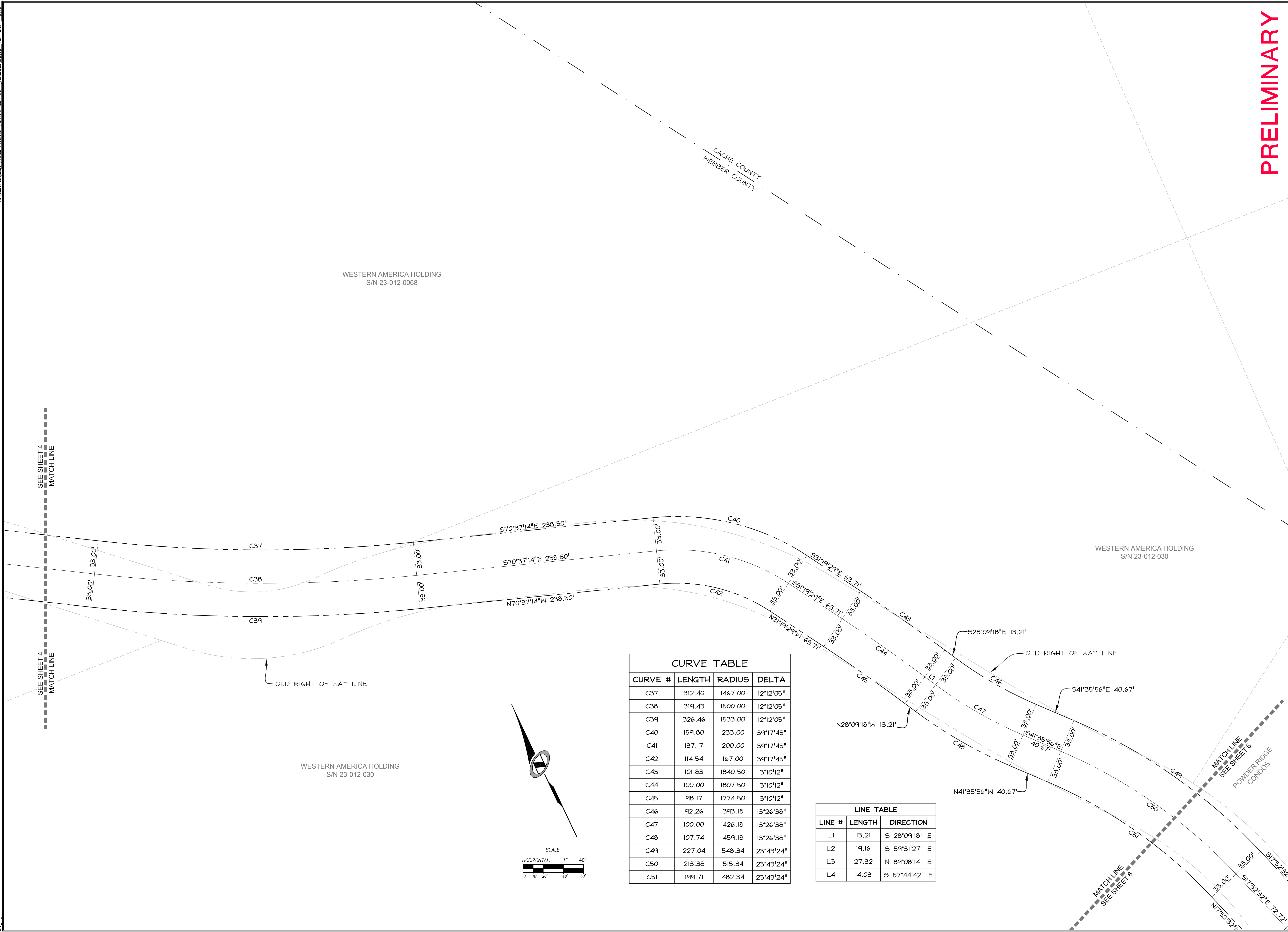

CURVE TABLE

CURVE #	LENGTH	RADIUS	DELTA
C37	312.40	1467.00	12°12'05"
C38	319.43	1500.00	12°12'05"
C39	326.46	1533.00	12°12'05"
C40	159.80	233.00	39°17'45"
C41	137.17	200.00	39°17'45"
C42	114.54	167.00	39°17'45"
C43	101.83	1840.50	3°10'12"
C44	100.00	1807.50	3°10'12"
C45	98.17	1774.50	3°10'12"
C46	92.26	393.18	13°26'38"
C47	100.00	426.18	13°26'38"
C48	107.74	459.18	13°26'38"
C49	227.04	548.34	23°43'24"
C50	213.38	515.34	23°43'24"
C51	199.71	482.34	23°43'24"

LINE TABLE

LINE #	LENGTH	DIRECTION
L1	13.21	S 28°09'18" E
L2	19.16	S 59°31'27" E
L3	27.32	N 89°08'14" E
L4	14.03	S 57°44'42" E

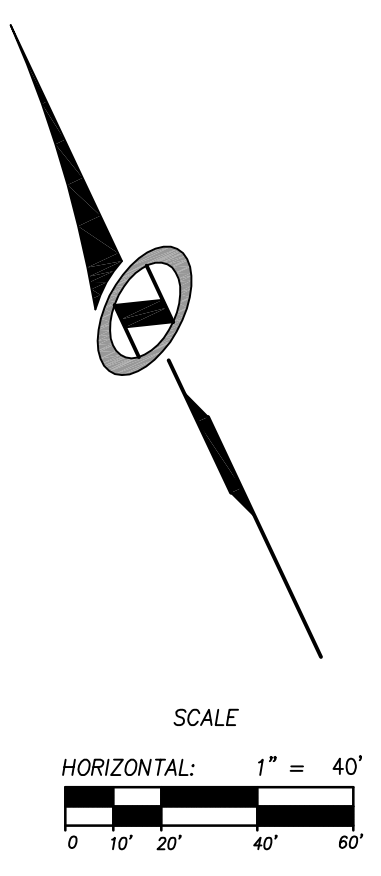

PRELIMINARY

NO.	BY	DATE	REVISIONS

SUMMIT AT POWDER MOUNTAIN PH-1
 POWDER RIDGE ROAD
 PRELIMINARY DEDICATION PLAN

PREPARED FOR: SUMMIT GROUP, LLC.
 DATE SUBMITTED: 12/21/2012

NV5

BEYOND ENGINEERING

MURRAY, UT 84107
 WWW.NV5.COM

527 SOUTH STATE STREET, SUITE 300
 801743800 TEL. 8017430800 FAX

SHEET NUMBER 5
OF 14 SHEETS
SCALE VERTICAL: 1" = N/A HORIZONTAL: 1" = 40'
JOB NUMBER SLB0799

The engineer preparing these plans will not be responsible for, or liable for, unauthorized changes to or uses of these plans. Any such changes or uses must be approved by the preparer of these plans.

DATE: 12/21/12 TIME: 12:07:10 PM DRAWING NAME: ST08.DWG
 SERVER: NONE PAGE SETUP: LAYOUT: 1
 NO. SUBORDINATE PHASE 1 SURVEY PLATS PRELIMINARY (R/S) (S/C) (C/A) (P/R) PROJ. NO.: ###

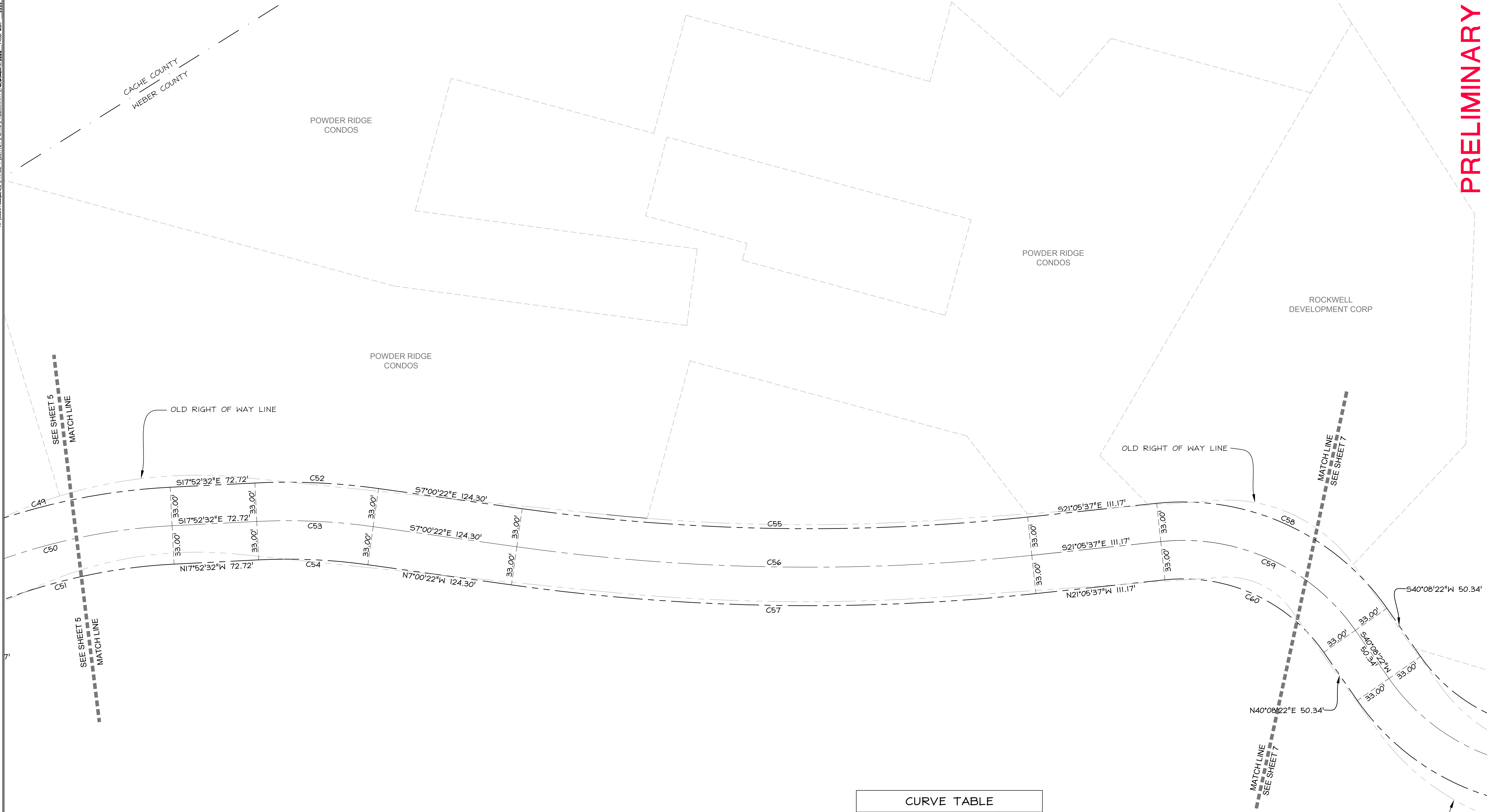

WESTERN AMERICA HOLDING
 S/N 23-012-030

CURVE TABLE			
CURVE #	LENGTH	RADIUS	DELTA
C49	227.04	548.34	23°43'24"
C50	213.38	515.34	23°43'24"
C51	199.71	482.34	23°43'24"
C52	106.26	560.12	10°52'10"
C53	100.00	527.12	10°52'10"
C54	93.74	494.12	10°52'10"
C55	434.46	1767.00	14°05'15"
C56	442.57	1800.00	14°05'15"
C57	450.69	1833.00	14°05'15"
C58	227.64	213.00	61°13'59"
C59	192.37	180.00	61°13'59"
C60	157.10	147.00	61°13'59"

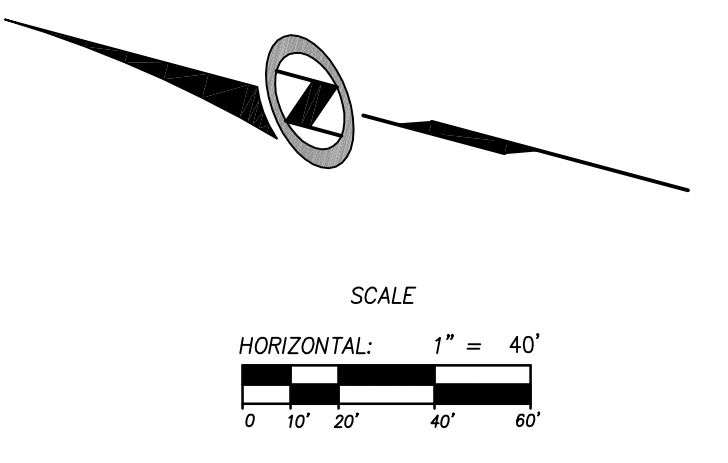

PRELIMINARY

NO.	BY	DATE	REVISIONS

SUMMIT AT POWDER MOUNTAIN PH-1
POWDER RIDGE ROAD
PRELIMINARY DEDICATION PLAT
 PREPARED FOR: SUMMIT GROUP, LLC.
 DATE SUBMITTED: 12/21/2012

NV5
 BEYOND ENGINEERING
 MURRAY, UT 8407
 WWW.NV5.COM
 527 SOUTH STATE STREET, SUITE 300
 801743800 TEL. 8017430800 FAX

SHEET NUMBER	6
OF	14 SHEETS
JOB NUMBER	SLB0793

CAUTION
 The engineer preparing these plans will not be responsible for, or liable for, unauthorized changes to or uses of these plans. Any such changes or uses must be approved by the preparer of these plans.

ALLEN XREES:

DATE: 12/21/12 TIME: 12:07:28 PM DRAWING NAME: S107.DWG
 SERVER: NONE PLOT SETUP: LAYOUT: LAYOUT1
 N:\SLB0798\ROAD\PHASE 1\SURVEY\PLANS\PRELIMINARY\ROAD\SLB0798.PLT PROJ. WDR: ###

ALLEN
 XREFS:

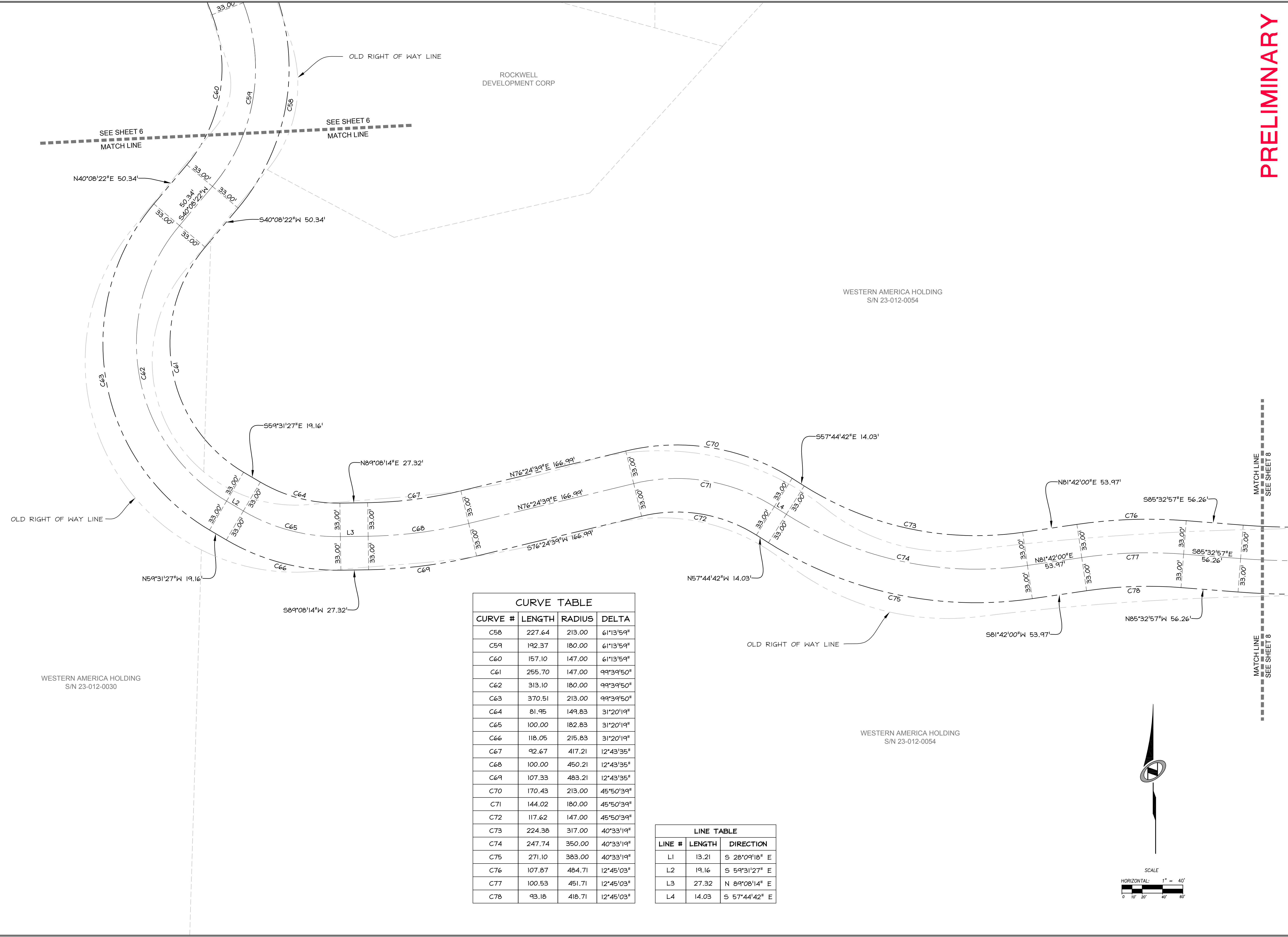

CURVE TABLE

CURVE #	LENGTH	RADIUS	DELTA
C58	227.64	213.00	61°13'59"
C59	192.37	180.00	61°13'59"
C60	157.10	147.00	61°13'59"
C61	255.70	147.00	99°39'50"
C62	313.10	180.00	99°39'50"
C63	370.51	213.00	99°39'50"
C64	81.95	149.83	31°20'19"
C65	100.00	182.83	31°20'19"
C66	118.05	215.83	31°20'19"
C67	92.67	417.21	12°43'35"
C68	100.00	450.21	12°43'35"
C69	107.33	483.21	12°43'35"
C70	170.43	213.00	45°50'39"
C71	144.02	180.00	45°50'39"
C72	117.62	147.00	45°50'39"
C73	224.38	317.00	40°33'19"
C74	247.74	350.00	40°33'19"
C75	271.10	383.00	40°33'19"
C76	107.87	484.71	12°45'03"
C77	100.53	451.71	12°45'03"
C78	93.18	418.71	12°45'03"

LINE TABLE

LINE #	LENGTH	DIRECTION
L1	13.21	S 28°09'18" E
L2	19.16	S 59°31'27" E
L3	27.32	N 89°08'14" E
L4	14.03	S 57°44'42" E

PRELIMINARY

NO.	BY	DATE	REVISIONS

SUMMIT AT POWDER MOUNTAIN PH-1
POWDER RIDGE ROAD
PRELIMINARY DEDICATION PLAT

NV5
 BEYOND ENGINEERING
 527 SOUTH STATE STREET, SUITE 300
 801743.8800 TEL. 801743.0800 FAX
 MURRAY, UT 84007
 WWW.NV5.COM

SHEET NUMBER
7
 OF **14** SHEETS
 SCALE
 VERTICAL: 1" = N/A
 HORIZONTAL: 1" = 40'
 JOB NUMBER
SLB0793

CAUTION
 The engineer preparing these plans will not be responsible for, or liable for, unauthorized changes to or uses of these plans. Any such changes or uses must be approved by the preparer of these plans.

DATE SUBMITTED: 12/21/2012

PREPARED FOR: SUMMIT GROUP, LLC.

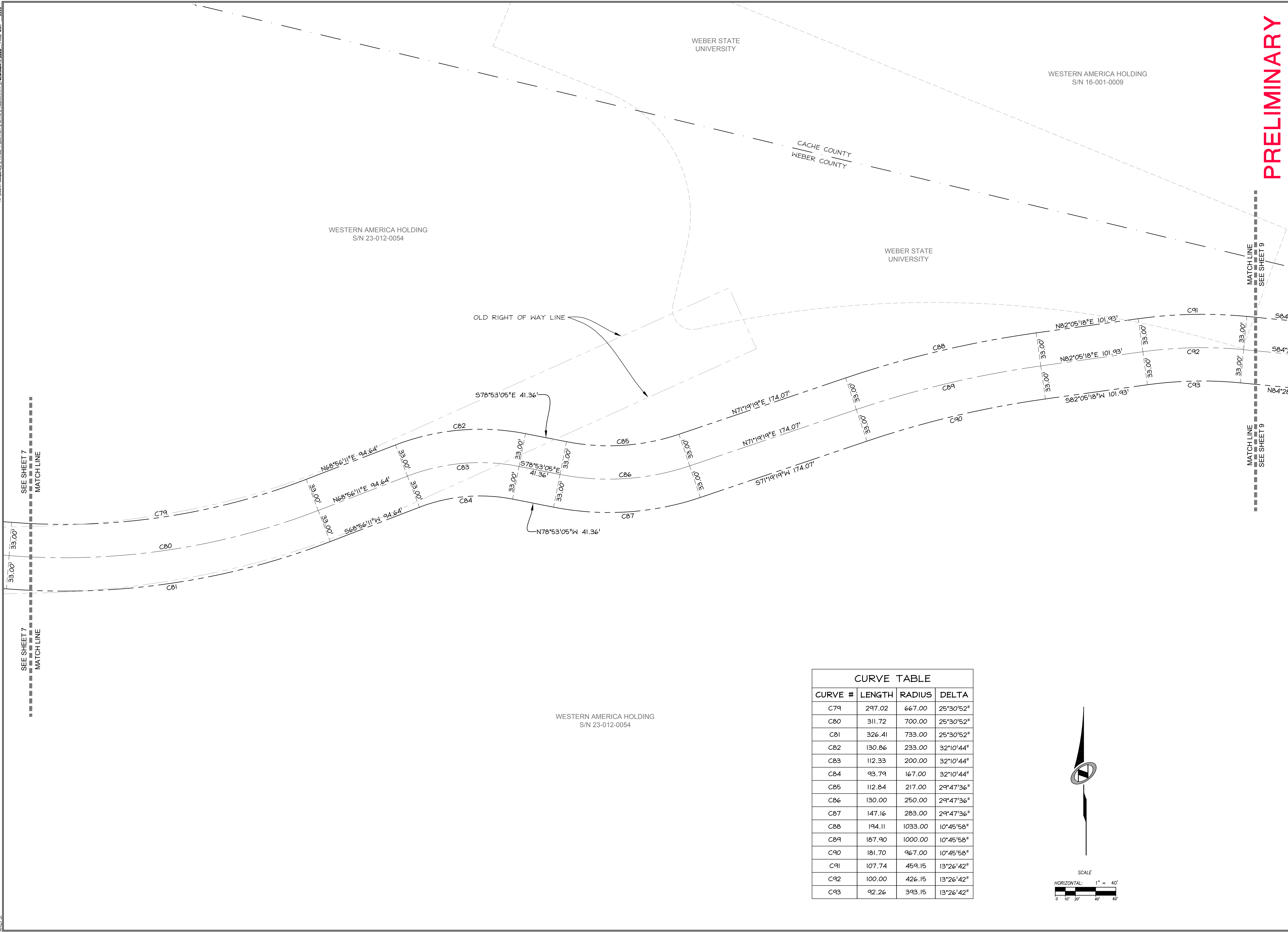

CURVE TABLE			
CURVE #	LENGTH	RADIUS	DELTA
C79	297.02	667.00	25°30'52"
C80	311.72	700.00	25°30'52"
C81	326.41	733.00	25°30'52"
C82	130.86	233.00	32°10'44"
C83	112.33	200.00	32°10'44"
C84	93.79	167.00	32°10'44"
C85	112.84	217.00	29°47'36"
C86	130.00	250.00	29°47'36"
C87	147.16	283.00	29°47'36"
C88	194.11	1033.00	10°45'58"
C89	187.90	1000.00	10°45'58"
C90	181.70	967.00	10°45'58"
C91	107.74	459.15	13°26'42"
C92	100.00	426.15	13°26'42"
C93	92.26	393.15	13°26'42"

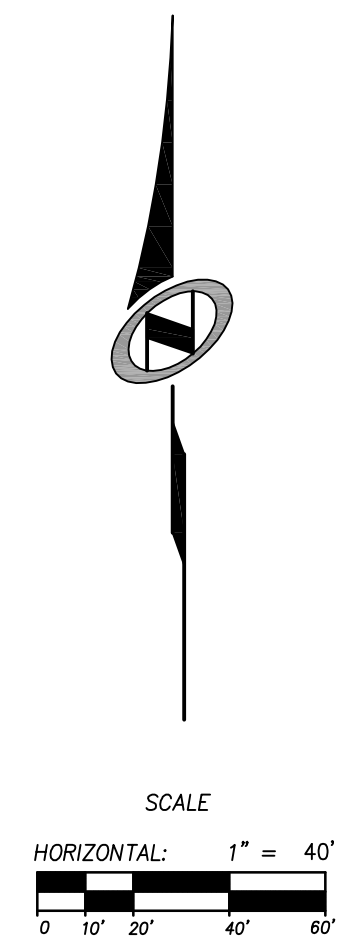

PRELIMINARY

NO.	BY	DATE	REVISIONS

SUMMIT AT POWDER MOUNTAIN PH-1

POWDER RIDGE ROAD

PRELIMINARY DEDICATION PLAT

DATE SUBMITTED: 12/21/2012

PREPARED FOR: SUMMIT GROUP, LLC.

NV5

BEYOND ENGINEERING

MURRAY, UT 84007
 WWW.NV5.COM

527 SOUTH STATE STREET, SUITE 300
 8017438800 TEL. 8017430800 FAX

SHEET NUMBER	8
OF	14
SHEETS	
SCALE	
VERTICAL: 1" = N/A	
HORIZONTAL: 1" = 40'	
JOB NUMBER	SLB0793

The engineer preparing these plans will not be responsible for, or liable for, unauthorized changes to or uses of these plans. The engineer's liability is limited to the preparation and must be approved by the preparer of these plans.

DATE: 12/21/12 TIME: 12:08:03 PM DRAWING NAME: S:\09.DWG
 SERVER: NONE PLOT SETUP: LAYOUT1
 NO. SUBPLOTS: 1 SURVEY PLATS: 1 PRELIMINARY: 0
 PROJ. NO.: 1111

ALLEN
 XREFS:

WESTERN AMERICA HOLDING
 S/N 16-001-0009

POWDER MOUNTAIN
 GROUP HOLDINGS
 S/N 16-001-0017

WESTERN AMERICA HOLDING
 S/N 23-12-0052

WESTERN AMERICA HOLDING
 S/N 23-12-0052

WESTERN AMERICA HOLDING
 S/N 23-12-0054

CACHE COUNTY
 WEBER COUNTY

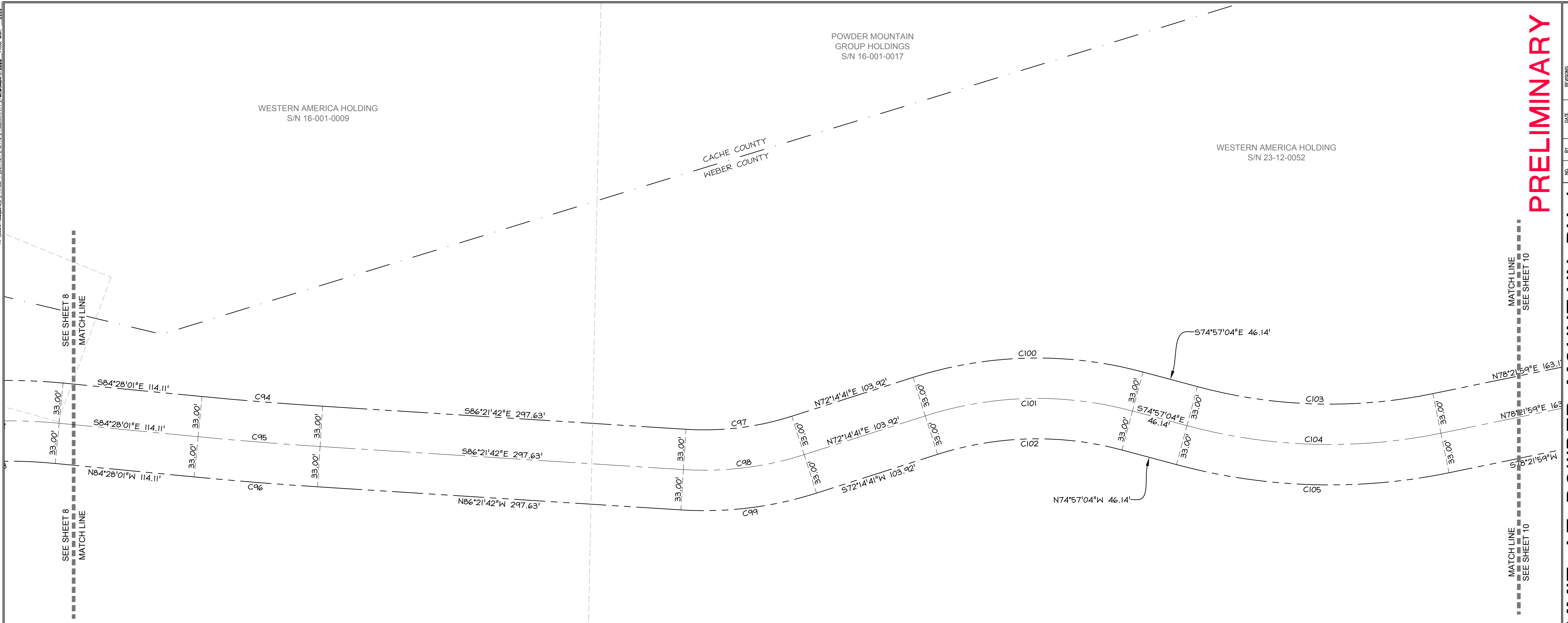

CURVE TABLE			
CURVE #	LENGTH	RADIUS	DELTA
C94	98.91	2990.76	1°53'41"
C95	100.00	3023.76	1°53'41"
C96	101.09	3056.76	1°53'41"
C97	87.68	234.82	21°23'37"
C98	100.00	267.82	21°23'37"
C99	112.32	300.82	21°23'37"
C100	190.65	333.00	32°48'14"
C101	171.76	300.00	32°48'14"
C102	152.87	267.00	32°48'14"
C103	194.19	417.00	26°40'57"
C104	209.56	450.00	26°40'57"
C105	224.93	483.00	26°40'57"

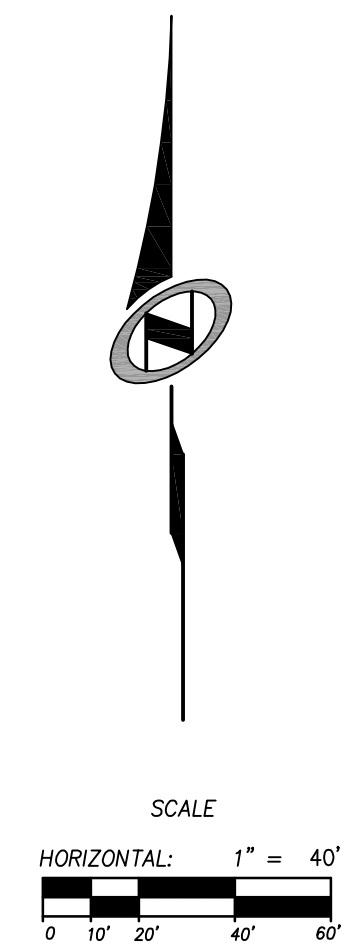

PRELIMINARY

SUMMIT AT POWDER MOUNTAIN PH-1

POWDER RIDGE ROAD
 PRELIMINARY DEDICATION PLAT

PREPARED FOR: SUMMIT GROUP, LLC.
 DATE SUBMITTED: 12/21/2012



MURRAY, UT 84107
 WWW.NV5.COM

527 SOUTH STATE STREET, SUITE 300
 801743.8800 TEL. 801743.0800 FAX

SHEET NUMBER	9
OF SHEETS	14
SCALE	1" = N/A VERTICAL: 1" = 40' HORIZONTAL: 1" = 40'
JOB NUMBER	SLB0793

The engineer preparing these plans will not be responsible for, or liable for, unauthorized changes to or uses of these plans. The engineer's liability is limited to the design and must be approved by the preparer of these plans.

WESTERN AMERICA HOLDING
 S/N 23-12-0052

WESTERN AMERICA HOLDING
 S/N 23-12-0052

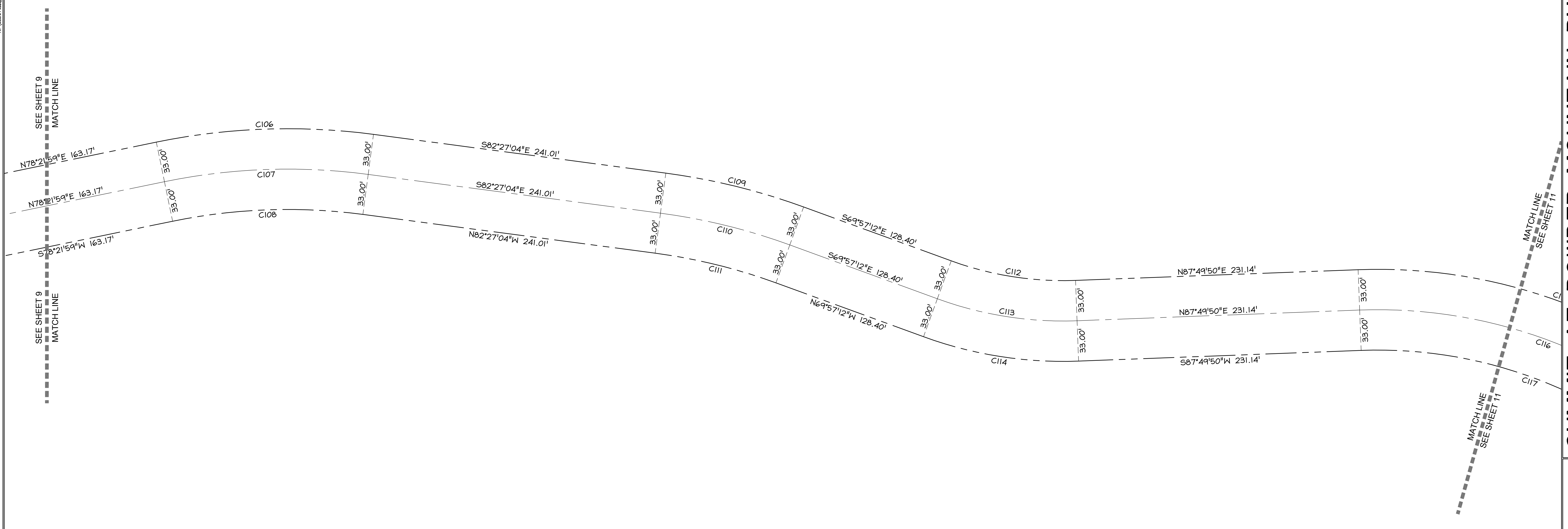

CURVE TABLE			
CURVE #	LENGTH	RADIUS	DELTA
C106	178.45	533.00	19°10'57"
C107	167.40	500.00	19°10'57"
C108	156.35	467.00	19°10'57"
C109	116.26	533.00	12°29'53"
C110	109.07	500.00	12°29'53"
C111	101.87	467.00	12°29'53"
C112	103.53	267.00	22°12'58"
C113	116.32	300.00	22°12'58"
C114	129.12	333.00	22°12'58"
C115	334.37	433.00	44°14'39"
C116	308.88	400.00	44°14'39"
C117	283.40	367.00	44°14'39"

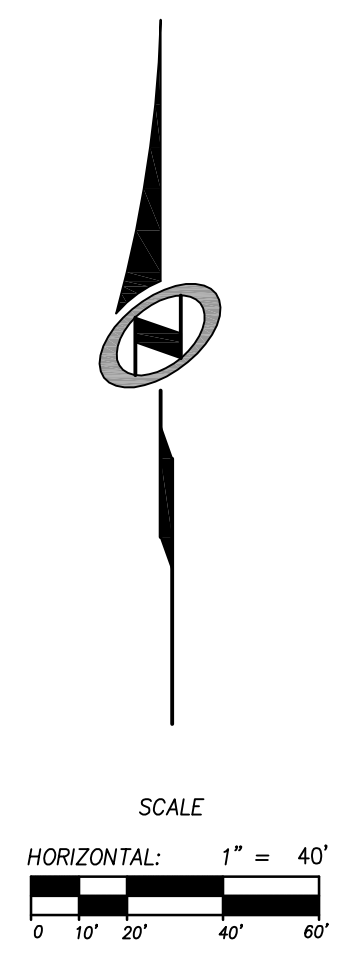

PRELIMINARY

SUMMIT AT POWDER MOUNTAIN PH-1
POWDER RIDGE ROAD
PRELIMINARY DEDICATION PLAN

PREPARED FOR: SUMMIT GROUP, LLC. DATE SUBMITTED: 12/21/2012

NV5
 BEYOND ENGINEERING
 MURRAY, UT 8407
 WWW.NV5.COM
 527 SOUTH STATE STREET, SUITE 300
 801743.8800 TEL. 801743.0800 FAX

SHEET NUMBER	10
OF	14 SHEETS
SCALE	VERTICAL: 1" = N/A HORIZONTAL: 1" = 40'
JOB NUMBER	SLB0793

CAUTION
 NO. BY DATE REVISIONS
 The engineer preparing these plans will not be responsible for, or liable for, unauthorized changes to or uses of these plans. Any such changes or uses must be approved by the preparer of these plans.

DATE: 12/21/12 TIME: 12:08:39 PM DRAWING NAME: ST11.DWG
 SERVER: NONE PAGE SETUP: LAYOUT: LAYOUT1
 N:\SUBPROJECTS\PHASE 1\SURVEY\PLATS\PRELIMINARY\WAS\SLB0793.DWG PROJ. WDR: ###

WESTERN AMERICA HOLDING
 S/N 23-012-0052

WESTERN AMERICA HOLDING
 S/N 23-012-0029

WESTERN AMERICA HOLDING
 S/N 23-012-0052

PRELIMINARY

SUMMIT AT POWDER MOUNTAIN PH-1
POWDER RIDGE ROAD
PRELIMINARY DEDICATION PLAT

DATE SUBMITTED: 12/21/2012

PREPARED FOR: SUMMIT GROUP, LLC.

MURRAY, UT 8407
 WWW.NV5.COM



527 SOUTH STATE STREET, SUITE 300
 801743.8800 TEL. 801743.0800 FAX

SHEET NUMBER

11
 OF **14** SHEETS

SCALE
 VERTICAL: 1" = N/A
 HORIZONTAL: 1" = 40'

JOB NUMBER
SLB0793

NO.	BY	DATE	REVISIONS

CAUTION

The engineer preparing these plans will not be responsible for, or liable for, unauthorized changes to or uses of these plans. Any such changes or uses must be approved by the preparer of these plans.

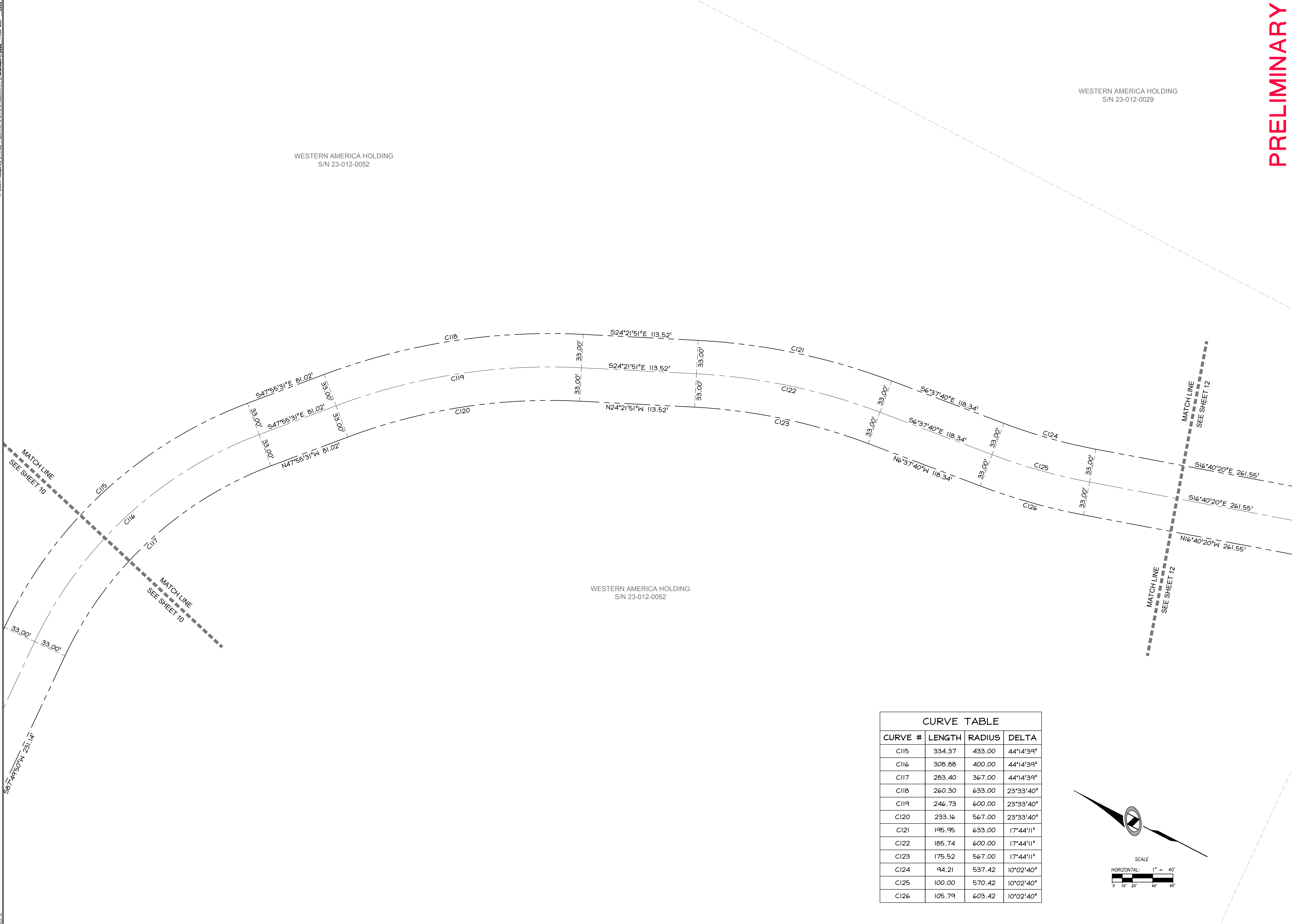

CURVE TABLE			
CURVE #	LENGTH	RADIUS	DELTA
C115	334.37	433.00	44°14'39"
C116	308.88	400.00	44°14'39"
C117	283.40	367.00	44°14'39"
C118	260.30	633.00	23°33'40"
C119	246.73	600.00	23°33'40"
C120	233.16	567.00	23°33'40"
C121	195.95	633.00	17°44'11"
C122	185.74	600.00	17°44'11"
C123	175.52	567.00	17°44'11"
C124	94.21	537.42	10°02'40"
C125	100.00	570.42	10°02'40"
C126	105.79	603.42	10°02'40"

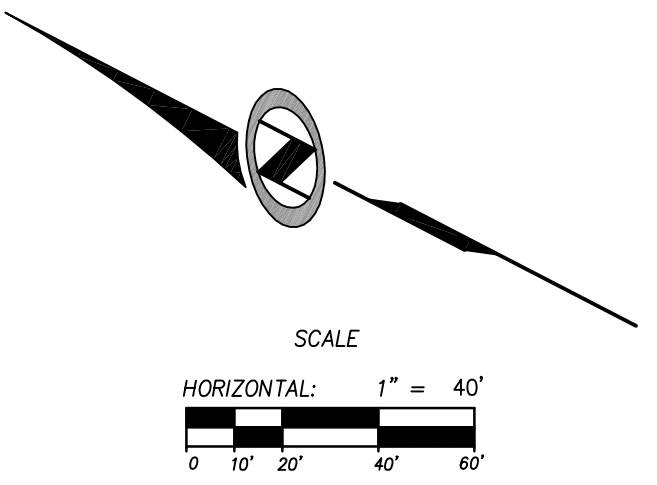

ALLEN
 XREES:

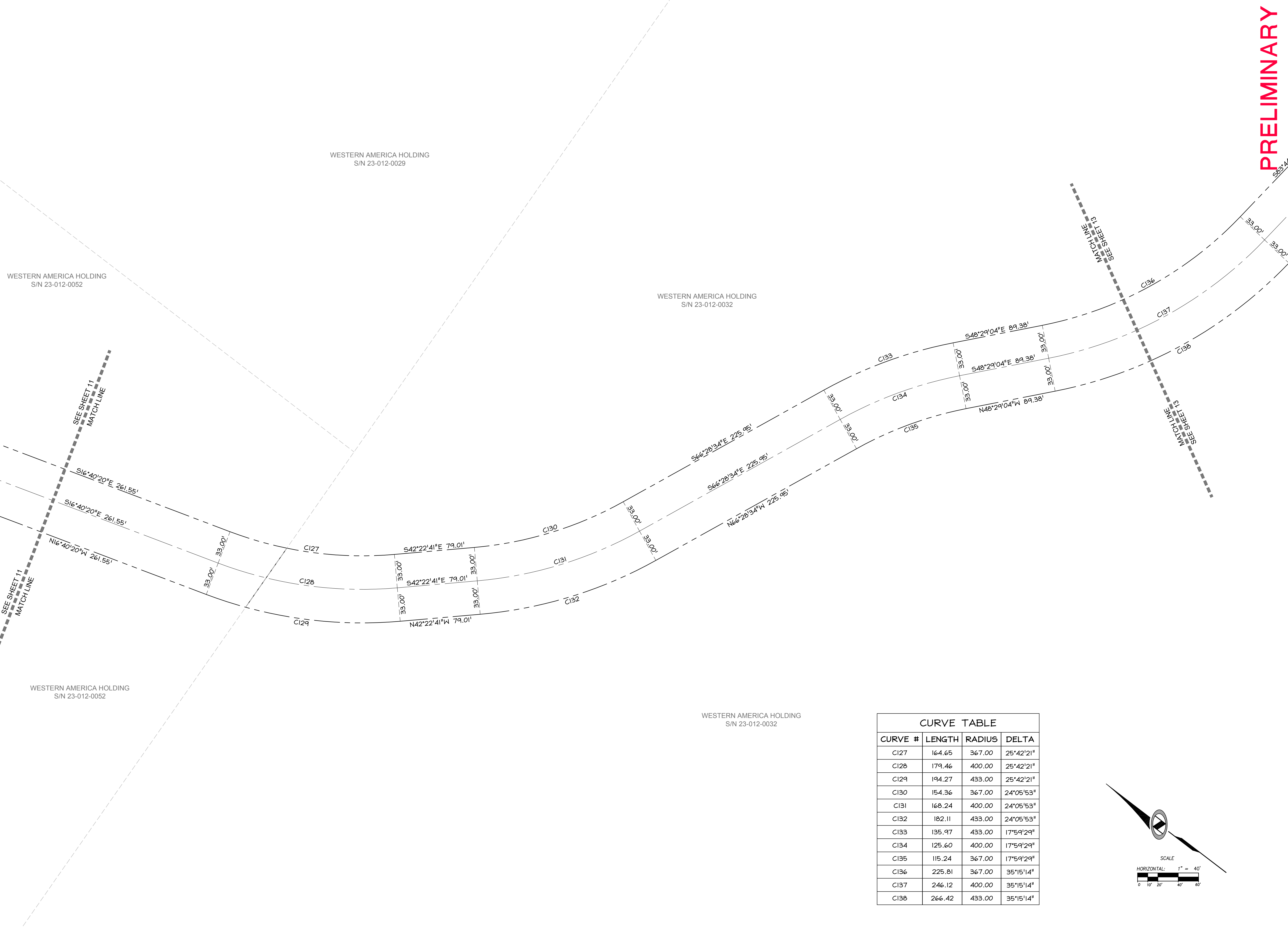

WESTERN AMERICA HOLDING
 S/N 23-012-0029

WESTERN AMERICA HOLDING
 S/N 23-012-0052

WESTERN AMERICA HOLDING
 S/N 23-012-0032

WESTERN AMERICA HOLDING
 S/N 23-012-0052

WESTERN AMERICA HOLDING
 S/N 23-012-0032

CURVE TABLE			
CURVE #	LENGTH	RADIUS	DELTA
C127	164.65	367.00	25°42'21"
C128	179.46	400.00	25°42'21"
C129	194.27	433.00	25°42'21"
C130	154.36	367.00	24°05'53"
C131	168.24	400.00	24°05'53"
C132	182.11	433.00	24°05'53"
C133	135.97	433.00	17°59'29"
C134	125.60	400.00	17°59'29"
C135	115.24	367.00	17°59'29"
C136	225.81	367.00	35°15'14"
C137	246.12	400.00	35°15'14"
C138	266.42	433.00	35°15'14"

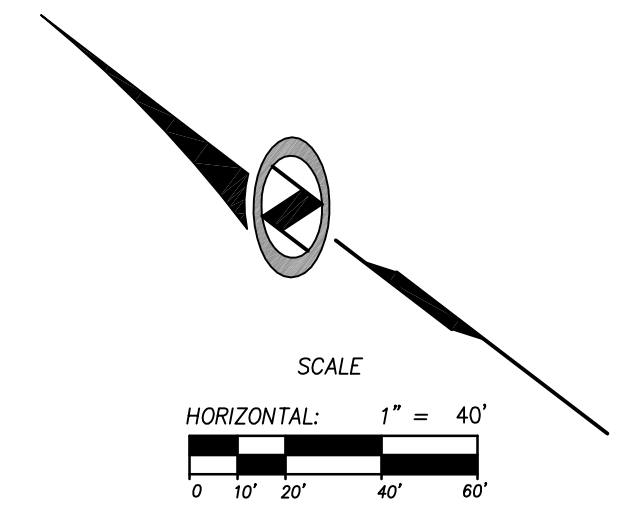

PRELIMINARY

NO.	BY	DATE	REVISIONS

CAUTION: The engineer preparing these plans will not be responsible for, or liable for, unauthorized changes to or uses of these plans. Any such changes or uses must be approved by the preparer of these plans.

SUMMIT AT POWDER MOUNTAIN PH-1
POWDER RIDGE ROAD
PRELIMINARY DEDICATION PLAT

DATE SUBMITTED: 12/21/2012

PREPARED FOR: SUMMIT GROUP, LLC.

NV5
 BEYOND ENGINEERING

527 SOUTH STATE STREET, SUITE 300
 801743.8800 TEL. 801743.0800 FAX

MURRAY, UT 84107
 WWW.NV5.COM

SHEET NUMBER	12
OF	14 SHEETS
SCALE	VERTICAL: 1" = N/A HORIZONTAL: 1" = 40'
JOB NUMBER	SLB0793

WESTERN AMERICA HOLDING
S/N 23-012-0032

WESTERN AMERICA HOLDING
S/N 23-012-0032

CURVE TABLE			
CURVE #	LENGTH	RADIUS	DELTA
C136	225.81	367.00	35°15'14"
C137	246.12	400.00	35°15'14"
C138	266.42	433.00	35°15'14"
C139	126.07	717.00	10°04'29"
C140	131.88	750.00	10°04'29"
C141	137.68	783.00	10°04'29"
C142	563.50	283.00	114°05'10"
C143	497.79	250.00	114°05'10"
C144	432.09	217.00	114°05'10"

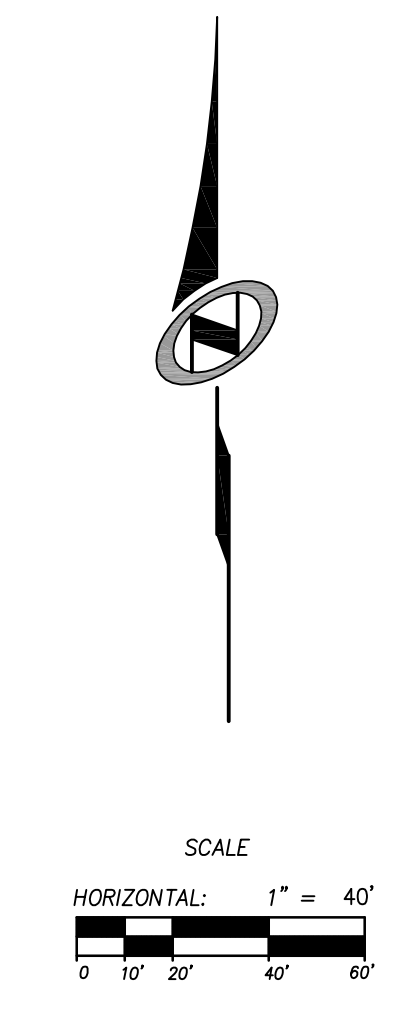
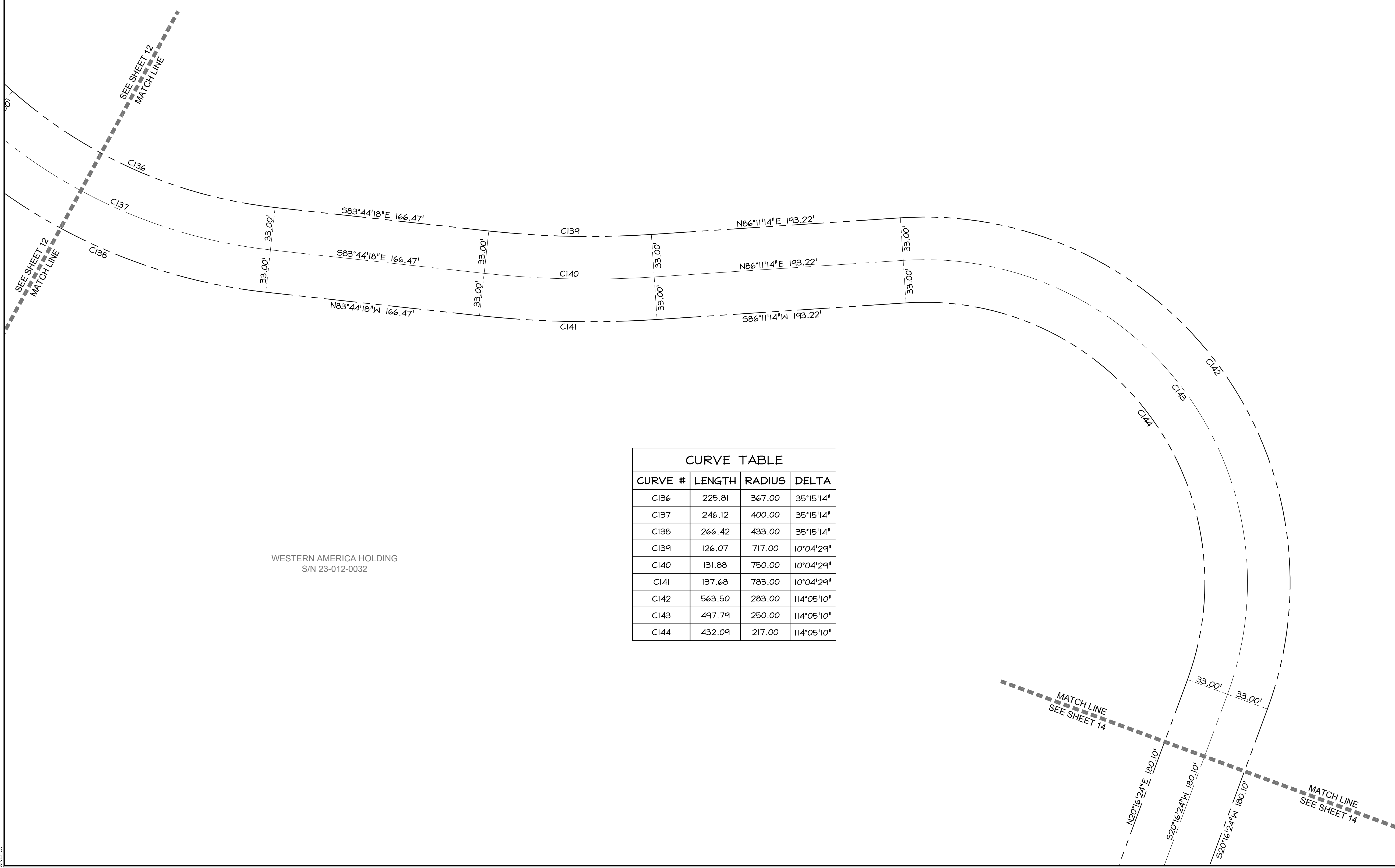

PRELIMINARY

SUMMIT AT POWDER MOUNTAIN PH-1

**POWDER RIDGE ROAD
PRELIMINARY DEDICATION PLAT**



527 SOUTH STATE STREET, SUITE 300
801743.8800 TEL. 801743.0800 FAX

MURRAY, UT 84107
WWW.NV5.COM

NO.	BY	DATE	REVISIONS

SHEET NUMBER: **13**
OF: **14** SHEETS
SCALE: VERTICAL: 1" = N/A HORIZONTAL: 1" = 40'
JOB NUMBER: **SLB0793**

DATE SUBMITTED: 12/21/2012

PREPARED FOR: SUMMIT GROUP, LLC.

CAUTION
The engineer preparing these plans will not be responsible for, or liable for, unauthorized changes to or uses of these plans. Any such changes or uses must be approved by the preparer of these plans.

WESTERN AMERICA HOLDING
 S/N 23-012-0032

WESTERN AMERICA HOLDING
 S/N 23-012-0032

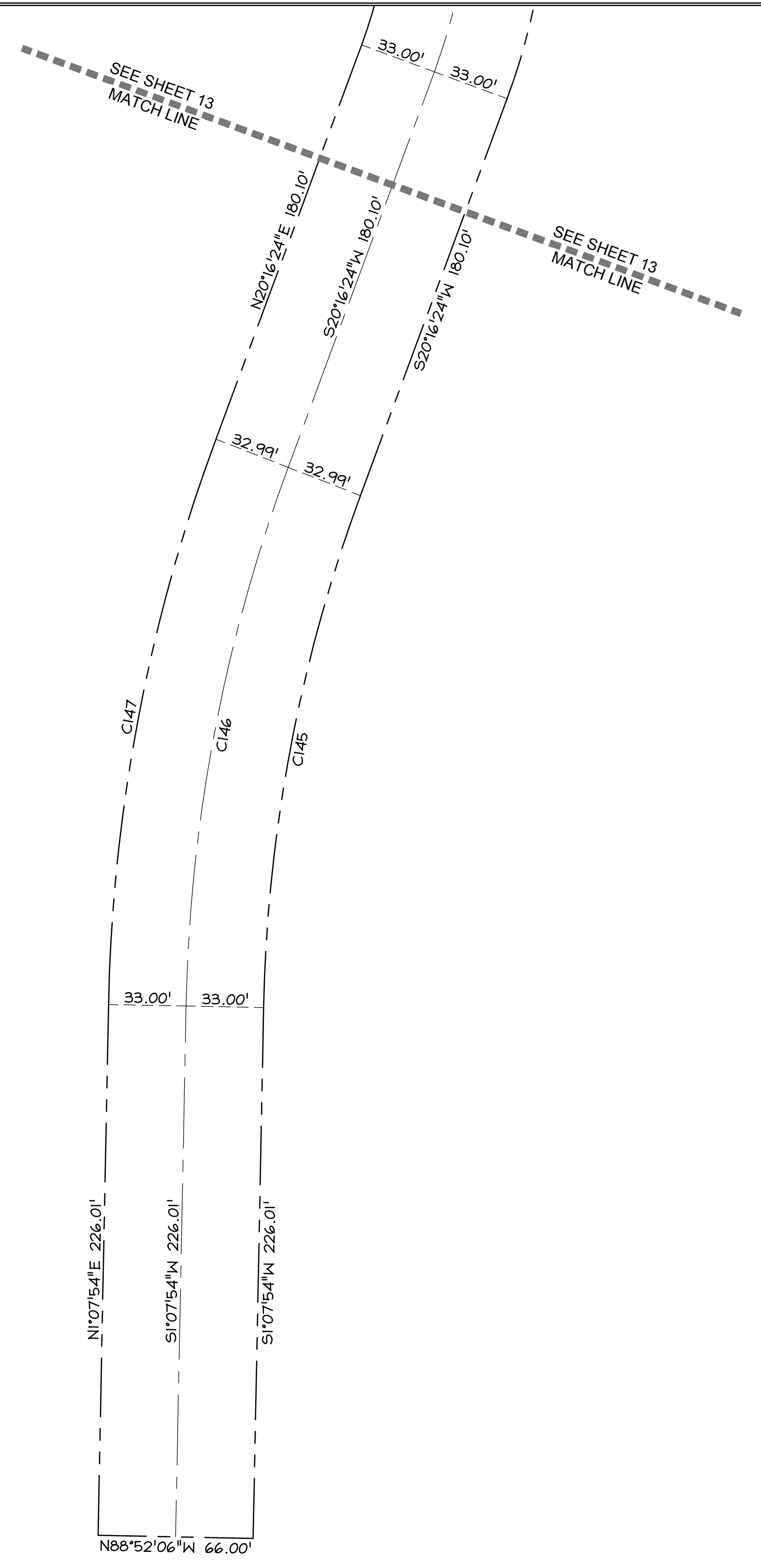

CURVE TABLE			
CURVE #	LENGTH	RADIUS	DELTA
C145	222.83	667.00	19°08'30"
C146	233.86	700.00	19°08'30"
C147	244.88	733.00	19°08'30"

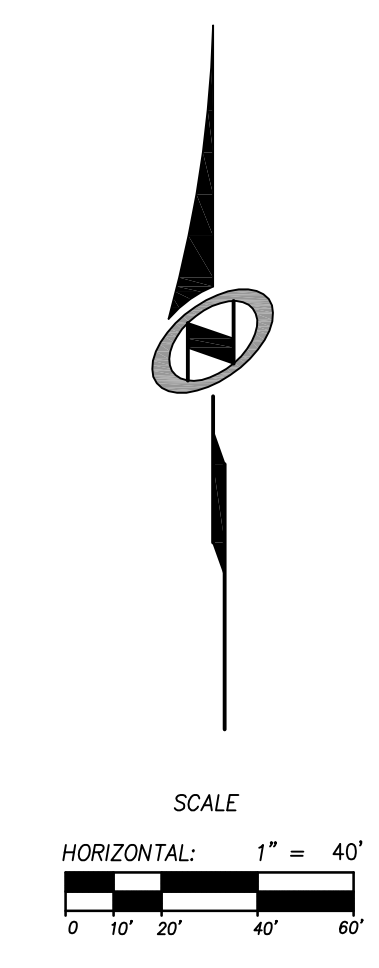

PRELIMINARY

SUMMIT AT POWDER MOUNTAIN PH-1

**POWDER RIDGE ROAD
 PRELIMINARY DEDICATION PLAN**



527 SOUTH STATE STREET, SUITE 300
 801743.8000 TEL. 801743.0800 FAX

MURRAY, UT 8407
 WWW.NV5.COM

SHEET NUMBER	14
OF	14 SHEETS
SCALE	VERTICAL: 1" = N/A HORIZONTAL: 1" = 40'
JOB NUMBER	SLB0793

PREPARED FOR: SUMMIT GROUP, LLC.
 DATE SUBMITTED: 12/21/2012

NO.	BY	DATE	REVISIONS

CAUTION
 The engineer preparing these plans will not be responsible for, or liable for, unauthorized changes to or uses of these plans. Any such changes or uses must be approved by the preparer of these plans.