

WESTERN WEBER PLANNING COMMISSION

MEETING AGENDA

March 10, 2020

5:00 p.m

- *Pledge of Allegiance*
- *Roll Call:*
-

1. Minutes for August 13, 2019 meeting.

Petitions, Applications, and Public Hearings

2. Administrative items

2.1 LVS021320: Consideration and action on a request for preliminary approval of Stagecoach Estates Cluster Subdivision consisting of 56 lots located at approximately 1800 S 3800 West, Ogden.

Applicant: *Patrick Burns; Staff Presenter: Tammy Aydelotte*

2.2 LVH 040419: Consideration and action on a request for preliminary approval of Halcyon Estates PRUD consisting of 39 lots located at approximately 4100 W 1800 S, Ogden.

Applicant: *Keith Ward; Staff Presenter: Steve Burton*

Petitions, Applications, and Public Hearings

3. Legislative items

3.1 ZTA 2019—01:Public hearing to discuss and take comment on a proposal to amend the following sections of Weber County Code: §101-1-7 and §108-7 to add a definition of agricultural building, amend the definition of agricultural parcel, and include provisions for agricultural building exemptions.

Applicant: *Weber County Planning Division; Staff Presenter: Steve Burton*

4. Public Comment for Items not on the Agenda

5. Remarks from Planning Commissioners

6. Planning Director Report

7. Remarks from Legal Counsel

8. Adjourn

The regular meeting will be held in the Weber County Commission Chambers, in the Weber Center, 1st Floor, 2380 Washington Blvd., Ogden, Utah.

Please enter the building through the front door on Washington Blvd. if arriving to the meeting after 5:00 p.m.

A Pre-Meeting will be held at 4:30 p.m. in Commission Chambers Break Out Room. The agenda for the pre-meeting consists of discussion of the same items listed above, on the agenda for the meeting.

No decisions are made in the pre-meeting, but it is an open, public meeting.

In compliance with the Americans with Disabilities Act, persons needing auxiliary services for these meetings should call the Weber County Planning Commission at 801-399-8791

Meeting Procedures

Outline of Meeting Procedures:

- ❖ The Chair will call the meeting to order, read the opening meeting statement, and then introduce the item.
- ❖ The typical order is for consent items, old business, and then any new business.
- ❖ Please respect the right of other participants to see, hear, and fully participate in the proceedings. In this regard, anyone who becomes disruptive, or refuses to follow the outlined procedures, is subject to removal from the meeting.

Role of Staff:

- ❖ Staff will review the staff report, address the approval criteria, and give a recommendation on the application.
- ❖ The Staff recommendation is based on conformance to the general plan and meeting the ordinance approval criteria.

Role of the Applicant:

- ❖ The applicant will outline the nature of the request and present supporting evidence.
- ❖ The applicant will address any questions the Planning Commission may have.

Role of the Planning Commission:

- ❖ To judge applications based upon the ordinance criteria, not emotions.
- ❖ The Planning Commission's decision is based upon making findings consistent with the ordinance criteria.

Public Comment:

- ❖ The meeting will then be open for either public hearing or comment. Persons in support of and in opposition to the application or item for discussion will provide input and comments.
- ❖ The commission may impose time limits for comment to facilitate the business of the Planning Commission.

Planning Commission Action:

- ❖ The Chair will then close the agenda item from any further public comments. Staff is asked if they have further comments or recommendations.
- ❖ A Planning Commissioner makes a motion and second, then the Planning Commission deliberates the issue. The Planning Commission may ask questions for further clarification.
- ❖ The Chair then calls for a vote and announces the decision.

Commenting at Public Meetings and Public Hearings

Address the Decision Makers:

- ❖ When commenting please step to the podium and state your name and address.
- ❖ Please speak into the microphone as the proceedings are being recorded and will be transcribed to written minutes.
- ❖ All comments must be directed toward the matter at hand.
- ❖ All questions must be directed to the Planning Commission.
- ❖ The Planning Commission is grateful and appreciative when comments are pertinent, well organized, and directed specifically to the matter at hand.

Speak to the Point:

- ❖ Do your homework. Obtain the criteria upon which the Planning Commission will base their decision. Know the facts. Don't rely on hearsay and rumor.
- ❖ The application is available for review in the Planning Division office.
- ❖ Speak to the criteria outlined in the ordinances.
- ❖ Don't repeat information that has already been given. If you agree with previous comments, then state that you agree with that comment.
- ❖ Support your arguments with relevant facts and figures.
- ❖ Data should never be distorted to suit your argument; credibility and accuracy are important assets.
- ❖ State your position and your recommendations.

Handouts:

- ❖ Written statements should be accurate and either typed or neatly handwritten with enough copies (10) for the Planning Commission, Staff, and the recorder of the minutes.
- ❖ Handouts and pictures presented as part of the record shall be left with the Planning Commission.

Remember Your Objective:

- ❖ Keep your emotions under control, be polite, and be respectful.
- ❖ It does not do your cause any good to anger, alienate, or antagonize the group you are standing in front of.

Minutes of the Western Weber Planning Commission meeting of August 13, 2019, held in the Weber County Commission Chamber, 2380 Washington Blvd. Floor 1. Ogden UT at 5:00 pm

Member Presents: Bren Edwards
Greg Bell
John Parke
Gene Atkinson
Jannette Borklund
Wayne Andreotti

Members Excused: Andrew Favero

Staff Present: Rick Grover, Planning Director; Charlie Ewert, Principle Planner/ Long Term Planner; Steve Burton, Planner III; Matthew Wilson, Legal Counsel; Marta Borchert, Secretary

- Pledge of Allegiance
- Roll Call

1. Approval of minutes for May 14, 2019, and July 9, 2019. Minutes were table to address needed corrections.

Petitions, Applications, and Public Hearings

2. Administrative items 2.1 CUP 2017-02: Consideration and action on an amendment to the Terakee Village PRUD conditional use permit. Applicant: Brad Blanch; Presenter: Steve Burton

Steve Burton states that this is a request to amend the conditional use permit for the Terakee Village PRUD. The request is to allow a secondary water pond in a previously designated open space area that has been approved. The reason for this is to add a secondary water provider in the area to get through the subdivision process and plat the lots. There is also a request that was not added, but he would like to add at this point. The request is to change the front yard setbacks from 30 ft to 20 ft. Staff recommends the approval of changes based on the findings of the conditions outlined in the staff report.

Brad Blanch 736 S 4700 W: states that the change for the secondary water pond is what Mr. Burton outlined, in the previous proposal it was designed to hook up to Hooper Irrigation's secondary water system. It is about a mile and a half away and the cost is high. The secondary water pond is intended to utilize water that they already have. Culinary water will be provided by Taylor West Weber Water. He asks if there is any question regarding this request.

Commissioner Bell asks where Mr. Blanch plans on putting the secondary water pond. Mr. Blanch notes that it would butt up against the irrigation canal. The detection pond will be set back from the road. The roads end there because they are meant to lead to the amenities that will be there. Also per the agritourism ordinance, there is an opportunity to put a farm home on site. That has not been determined yet. The secondary water pond needs to hold 1-acre ft of land approximately 4 ft deep of water. The geo-tech report shows that in that area that the water table is 4ft down that is as deep as it would go because of the Geo tech.

Chair Edwards asks if with the proposed secondary water system it will take care of this PRUD or others. Mr. Blanch states that it would take care of this one. He adds that they have designed the secondary water system to dead-end into 900 S, on both entrances so that when there is a secondary water provider in the area they can connect to and take over the system. Chair Edwards asks who is going to manage the system. Mr. Blanch states that they are forming an association call Terakee Water Association. It is going to be the same entity that is going to own the open space. The streets and open spaces are private. It will be Terakee Farms Inc. which is a not for profit. They will be in charge of managing the program. The fees will be collected and put in a fiduciary account to manage the water.

Commissioner Atkinson asks if Mr. Blanche's intent is to fence the secondary water pond. He states that he would like clarification regarding Mr. Blanche's statement that it could be a part of the open space for future use. He adds that there will be fencing standards which will be included in the CCNR's. There will not likely be fencing in the front yards. Commissioner Borklund states that it would be good to add a restriction for a front yard fence because if someone put a fence in the front yard it does away with the open space. Mr. Blanch states that he agrees this would be a good requirement to put in. Mr. Blanch states half of the property is dedicated to open space. The open space there will be used for agriculture for now. There is a variety of options that are available for the agritourism ordinance. The detention pond will just be used for secondary water for the open space as well as the residential. He adds that they do intend to fence. Mr. Atkinson asks if it will be used as a public pond at any point. Mr. Blanch states that it is not.

Commissioner Bell asks if they have a proposed detention pond already by the assisted living area. Mr. Blanch states that they did originally have a proposed detention pond, but it was found through the wetland assessment that the area is a wetland area. He adds that while the Army Corp of Engineers would allow them to use it as a detention pond it would take a few years to work through to be able to use it in that way. There would need to be a two for one wetland for the regular land exchange. It would need to be managed for a few years to make sure that it works. The wetland area that can be seen, will stay a wetland. The Army Corp Engineers have done their study and there has been a wetland study done and archaeologist has been hired to review the site as well. All the studies have been done and they are waiting on the final letter from the Army Corp Engineers to close out the wetland issue.

Chair Edwards asks if they are proposing their detention pond secondary water system also be stormwater detention? Mr. Blanch states that it not. The stormwater basin for phase 1 is located in the open space area where A and B are located. It is referred to as the buck ditch which is a secondary water canal that provides water to the South it will be piped and will no longer be a dirt ditch. It will facilitate stormwater on the westside of the canal by the time final approval is brought before the Planning Commission.

Mr. Blanch states that regarding the setback because the streets are private they were able to negotiate 50 ft right of ways. All the houses in this development are going to be bungalow style or modern farmhouse. The intent is to have a get to know your neighbor community with the houses being closer together. He adds that his request is to have the front yard setbacks be consistent with the width of the right of way and be consistent with the other project that he is working on. The request is for 20 ft front setbacks. It was an oversight on their part that when they went through the PRUD process they were listed as 30ft and the intent all along was for it to be 20ft.

Commissioner Bell asks what is to be gained from the extra 10ft. Mr. Blanch states that because of secondary water they would like to do some nativescaping and limit the sizes of yards. There will be front yard and side yard landscaping plans. There will be less usage of water and bringing the homes closer from across the street. There won't be much impact beyond that. It is mostly those two things.

Chair Edwards asks if there are any further questions. there are none.

Director Grover states that regarding conditional use he would like to mention that sometimes when there are de minimus changes they can be approved by the director because this is regarding open space they felt that was not de minimus which is why it was brought before the Planning Commission.

Chair Edwards the public comment. There is none.

Chair Edwards closes the public comment.

Commissioner Borklund states she has a question for staff. She asks if eliminating this as open space, will it affect any of the existing ordinances space and the bonus density that was given. Mr. Burton states that this something that the Planning Commission would need to decide. If the Planning Commission decides that it is not open space then they can make that change through the findings in the motion.

Mr. Blanch states that the bonus density on this project is about 33% the opportunity is 50%. He adds that if the Planning Commission feels the need to reduce the bonus density, it would not likely impact the lots. He did the math and there are 80 units in the project. There are 80 lots and 4 ADU's it would eliminate possibly eliminate 2 of the accessory dwelling units.

Commissioner Parke states that this goes back to the question of whether detention or retention ponds or water systems should be considered open space. Chair Edwards states that a lot of time retention ponds equal half of what a full credit would be. He adds that in his opinion it is a utility, a necessity to the development. Commissioner Borklund states that if it is fenced and it is not accessible to the residents it is not a benefit to them. Commissioner Bell states that it sets a bad precedent to count any sort of detention area as open space when its completely unusable property. Chair Edwards states that a regular basin normally landscaped with grass which has a beneficial use, this is going to have water in at most times. He adds that regarding the setbacks it shouldn't be a big issue, for most people it is more of a benefit. Commissioner Atkinson asks if Mr. Wilson has a comment on the position of the detention pond. He asks if the property owner has the right to do this, or does the Planning Commission have the right to block it. Mr. Wilson gives the definition in the PRUD ordinance. In §108-5-1 of the County ordinances "*Common open space means land area in a planned residential unit development reserved and set aside for recreation uses, landscaping, open green areas, parking and driveway areas for common use and enjoyment of the residents of the PRUD*" He notes that it is not clear whether it is open space or not. Commissioner Parke asks what way could that be construed under the definition of open space. Mr. Wilson states that there could be arguments made for both sides. Director Grover states that if the developer was to develop it in such a way that it had an aesthetic appearance it could be counted as open space. This why the Planning Staff has recommended approval. Having a water feature or something that can add some aesthetic value. Typically a detention area is typically dry and looks like a big hole. They might look nice in the springtime and at other times won't look kept. Commissioner Atkinson strongly recommends the aesthetic features be added to make it like a pond. If is going to be listed as open space it needs to look like open space, not a wasteland. Director Grover states that they can ask Mr. Blanch if he willing to do this, and what his thoughts are. Mr. Blanch states that he agrees it should be landscaped all the way around native and natural-looking as possible. He is not sure what the criteria are on fencing but it needs to be secure so that kids can't get in. The fencing could be native and aesthetically done well. Chair Edwards states that the fence disqualifies it from being open space. Commissioner Andreotti states that if they are going to look at it as an aesthetic item that doesn't change the density they need to see what that is before they make a decision.

Director Grover states that Mr. Blanch has been held up on this development and they are trying to get him through the process as quickly as possible. If there is a way that the Planning Commission would feel comfortable seeing stormwater area picking up an aesthetic value, they can include in the motion that it will have a naturalistic pond cape with a rod iron fence, that could meet the intent.

Commissioner Bell states that if it going to be an aesthetic pond he wants to look at the requirement that states that there is going to be a fence around it. If there is going to be a fence around it, it is no longer open space. It is isolated for utility use and its, not for the public or the residents. He adds that he wants to see a proposal with something that is aesthetically pleasing and no fencing. Mr. Burton states that he has been looking to the requirement or fencing something of this nature. It is not something that the land-use code requires. It is an engineering requirement. Mr. Blanch states that he agrees with everything commissioner Bell has said. He would prefer not to fence it. He would like to landscape it in an aesthetically pleasing way. He adds that this is the last hurdle that they are trying to work through, and he would love a decision today. If the Planning Commission requires him to landscape or if he needs to lose a couple of ADU's that not a problem.

Chair Edwards states that the hang-up is that it is a secondary utility. It is not a detention basin it is a secondary water pond. There is going to be a building and pump system coming out of it. This solely for the purpose to provide secondary water to the area. Mr. Blanch states that he would like to mention that the detention basins in the area in the final engineering drawings for stormwater detention have sprinkler irrigation in them. They are fully landscaped. Typically secondary ponds are not aesthetically pleasing, in this design it is the Hooper Irrigation canal. It is a fully covered canal, the plan calls for landscaped walking paths along the canal. Directly to the south, there is a dugout area, there is a lot of xeriscaping in there already.

Chair Edwards asks if there should be a split motion. Director Grover state that they can look at approving the setback. It can be tabled, to allow Mr. Blanch to come back with more detailed drawings. That they can look at the 20ft right of way and add conditions that will address concerns or deny it as open space. He adds that they are not really setting a precedent because A and B have already been accounted for as open space. If the Planning Commission were to consider it open space they could add parameters to make sure it meets the same intent that A and B were approved under. Chair Edwards asks if the code has changed since this development was approved. Director Grover states that it has not. It's just in the cluster code. He adds that they are working on it but it hasn't gotten to that point yet.

MOTION: Commissioner Parke moves to approve the setback of 20 ft with the condition that no fencing be placed in the front yard the recommendation is based on the findings that it is contiguous with other PRUD's in the area. Commissioner Atkinson seconds. Motion carries (6-0)

Commissioner Andreotti states that he feels that the pond should not be counted as open space.

MOTION: Commissioner Borklund moves to recommend denial of the stormwater pond as open space. Commissioner Parke seconds. Motion carries (5-1) Commissioner Atkinson votes Nay.

Commissioner Atkinson states that either way he feels very strongly about two things. First that it be aesthetically pleasing. Secondly that the long term management be addressed.

Director Grover states that they will want to include findings to go with it and there are conditions for the secondary water system that are outlined in the staff report. He adds that even though it is not being approved as open space it is still being approved as a secondary water system. Mr. Burton also had some requirements for the secondary system. Mr. Burton states that the applicant would still like the stormwater detention pond even though it is not being called open space. It might be worth another motion to decide as a Planning Commission to decide how much bonus density is going to be taken away because of open space.

MOTION: Commissioner Bell moves to amend the previous motions to recommend the conditional use permit for Terakee Village PRUD (CUP 2017-02). This recommendation for approval is subject to all review agency requirements and is based on the following conditions: 1. All conditions from the original conditional use permit approval are still applicable. 2. The applicant must obtain approval from the state for the new secondary water system prior to subdivision approval from the County Commission, and that the setbacks be changed to 20 ft for front yard with the condition that no front yard fences be allowed. A landscape plan be added to the secondary water basin. The approval of this application is based on the following findings: 1. The proposed secondary water detention area does decrease the amount of open space as it is not considered open space. Commissioner Borklund seconds. Motion carries (6-0)

3. Public Comment for Items not on the Agenda: there was none

4. Remarks from Planning Commissioners: Chair Edwards states that it would be good to have two meetings a month to get through some of the work sessions that keep being postponed and that some of the items being discussed at the joint work sessions are not pertinent to both Western Weber Planning Commission. It would reduce the number of items on the agendas, and they can be held on as needed bases. Director Grover states that he will talk to staff and see if it is a possibility. Mr. Ewert states that he believes that there is a great benefit to having joint meetings. It was easier to work through some of the issues with both Planning Commissions Present. Commissioner Borklund and Commissioner Atkinson note that it would be hard for them to attend a second meeting because of scheduling conflicts.

5. Planning Director Report: there was none.

6. Remarks from Legal Counsel: there was none.

7. Adjourn to Work Session: 5:58 pm

WS1: A discussion regarding Street Connectivity Policies. Township + Range consultants, partnered with Wasatch Front Regional Council, will present street connectivity best practices and how they could be applied in Weber County.

Mr. Ewert states that Tim Sullivan from Township and Range is present they have been contracted by the Wasatch Regional Council (WFRC) and UDOT with state funds to work with local jurisdictions on street connectivity. They don't have any legislative control, they have funding. There have been discussions regarding shared public lane and street connectivity, layout and access. Tim will discuss the ties.

Tim states that they did a project with WFRC and MPO in Utah County looking into benefits and tools for street connectivity. He adds that he had a conversation with UDOT to see if they could start implementing some of those recommendations in the quickly growing communities. He states that he had an excellent conversation with the Ogden Valley Planning Commission. They trying to look at the bigger picture and look at what the streets are doing. Streets form the frame for the communities, they are really important in shaping the places where we live, work, and play. There are four aspects of street connectivity scale, density, destination, and connectivity for everyone, not just vehicles. The most obvious benefit is the connectivity. Often times making one small connection can increase the number of people that can access a key destination. The benefits often expand to mobility and health. It improves emergency services and response times for snowplows and emergency vehicles. It is safer in connected networks. It helps the economy because they are walkable and hikeable. It is important to keep in mind that street connectivity is not one size fits all. There are ways to connect all types of street networks without compromising the essential characters. One misconception is that connected street networks don't allow cul-de-sacs. There needs to be a balance, there can't be too many of them and they can be too long. In rural areas, it might be a challenge because agricultural areas might become a barrier, and pedestrian infrastructure needs to be strategic. In suburban areas, the lengths of cul-de-sacs need to be limited and make sure they are well connected for pedestrians. There are some tools that can be used to create good street connectivity. 1. Looking at plans and policies. 2. Looking at development standards. 3. Looking at retrofitting strategies to fix streets networks that weren't done right in the first place. In areas that currently being developed, there is an opportunity to shape sustainable connected networks. He adds that one thing he has noticed is the lack of external connection and if they are not well connected it doesn't matter what the internal connection is. There needs to be well-spaced connections and work around issues like canals.

Chair Edwards states that demographically there are a few issues in the area.

Commissioner Parke states that it is important to plan for the future. The general plan needs to be updated. The reality is that the area won't stay rural the agriculture is going to be gone. It is important to plan for schools, churches and grocery stores. Chair Edwards states that there is a good grid in the area for main roads. Commissioner Parke agrees but states that when you get out to 12th Street if a train were to derail that would cause a lot of problems. It is a hazard.

Commissioner Bell states that the General Plan needs to be outlined and updated the eliminating clusters from certain areas and creating residential zone versus A-1, A-2, or A-3. He asks how do plan for that? The longer we wait for the harder it is going to be to deal with that. Chair Edward states that the General Plan is not going to fix that. The General Plan is going to plan big-picture things. Commissioner Bell states that maybe not but it will help for the future. At this point, the land is getting piece barred because there is no plan in place to structure. Mr. Ewert states that the General plan can have a transportation plan. Mr. Sullivan states that none of the standards is performance-based nobody drawing exactly where the lines need to go. It is a standard that the developer must meet.

Mr. Ewert states that they have asked Mr. Sullivan to assist with deliverables. They have asked regarding recommendations on what can be done in the ordinance. Since the Planning Staff is working on subdivision code it would be good to tackle this as well. Mr. Sullivan states that the whole idea of egress and ingress is based on a subdivision that has a few connections to the street network as possible each project is put together and it just becomes one connected network.

Commissioner Atkinson asks regarding the Terakee Village project. He states that he is glad there is a stub egress to the north. He wonders if there ought to be one to the east side? Chair Edwards states that there can be nothing on the east side because it goes to the water district.

Commissioner Bell states that he believes the burden should be placed on the developer. As long as they are allowed to maximize lot development and ignore connectivity there will be a major problem. Mr. Ewert states that this is something the Planning Staff has been discussing. He states that they have been discussing what is expected and how the current code can be reformed for better outcomes. He asks what kind of retrofit strategies have been implemented in other areas. Mr. Sullivan states that it has consisted of getting pathways through cul-de-sacs, getting easements through properties and possibly buying properties, adding crosswalks and pedestrians access across busy streets. The worse the connectivity is the bigger the streets have to be. It becomes a barrier. Mr. Ewert states that it limits access opportunities for the underserved population. Mr. Sullivan notes that this is something that can sometimes be fixed through redevelopment.

WS2: A discussion regarding new medical cannabis permissions in state code and how they may affect the Land Use Code.

Mr. Ewert states that the State has said that if a municipality or county provides an industrial zone the municipality or county shall ensure the industrial zone allows for 1 medical cannabis production in at least 1 type of industrial zone. If a municipality or county zoning ordinance provides for an agricultural zone the municipality or county shall ensure that the ordinance allows for cannabis production in at least 1 type of agricultural zone. He notes that Weber County has both, so the challenge becomes how to fit it into the agriculture zone and the industrial zone. He notes that they are called medical cultivation facilities. The cultivator will grow, dry, and package. It will then be sent to a state-run lab to be tested and labeled. The state is requiring that the County allow for a cultivation facility in the industrial zone and the agricultural zone. The facilities are all indoor. They are high security, fenced, cameras. They are reliant on electricity. It cannot be planted in native soil. There were 8 permits issued in the states of Utah. All 8 went out of state vendors because they have experience in growing. The cultivation facility has to be in the state and cannot produce for outside state lines. The facility cannot be within 600 ft of residential use area, and 1000 ft from community location. Commissioner Borklund states that the A-1 zone is being used as residential but isn't zoned as residential. Mr. Ewert agrees and states that these issues occur when the legislature doesn't understand how the zoning works. It is not one size fits all. In Weber County A-1 and A-2 both allow residences at the same density but are agricultural zone not residential. As far as regulating medical cannabis in the M-3 zone is being proposed a permitted use. In the A-3 zone, it is proposed as a conditional use. Mr. Ewert states that according to the state legislature it needs to be allowed in 1 agriculture zone. He asks if there are any concerns from the Planning Commissioners regarding this issue. There are none. He adds that this will be a vacuum in the market and it will likely expand quickly. They agree that it should be listed as a permitted use in the M-3 zone and the A-3 zone. Mr. Ewert states that standards will be added, any restrictions need to be reasonable.

WS3: A discussion and review regarding subdivision code amendments.

Commissioners agree they don't want shared private lanes and flag lots in Western Weber County.

WS:4 A discussion and review regarding the proposed land use table.-Postponed

Meeting Adjourned - 8:02 pm



Staff Report to the Western Weber Planning Commission

Weber County Planning Division

Synopsis

Application Information

Application Request: Consideration and action on a request for preliminary approval of Stagecoach Estates Cluster Subdivision consisting of 55 lots located at approximately 1800 South 3800 W, Ogden.

Type of Decision: Administrative

Agenda Date: Tuesday, March 10, 2020

Applicant: Pat Burns

File Number: LVS021320

Property Information

Approximate Address: 1800 S 3800 W

Project Area: Approximately 40 acres

Zoning: Agricultural (A-1) Zone

Existing Land Use: Agricultural

Proposed Land Use: Residential

Parcel ID: 15-057-0006

Township, Range, Section: T6N, R2W, Section 21

Adjacent Land Use

North: Agricultural	South: 1800 South
East: Residential/Agricultural	West: Residential

Staff Information

Report Presenter: Tammy Aydelotte
taydelotte@co.weber.ut.us
801-399-8794

Report Reviewer: SB

Applicable Ordinances

- Weber County Land Use Code Title 104 (Zones) Chapter 5, Agricultural (A-1 Zone)
- Weber County Land Use Code Title 106 (Subdivisions)

Background and Summary

Sketch plan endorsement was given December 10, 2019. The applicant is requesting preliminary approval of Stagecoach Estates Cluster subdivision consisting of 55 lots, located at approximately 1800 S 3800 W, Ogden.

Analysis

General Plan: The proposal conforms to the Western Weber General Plan by preserving agricultural open space with open space easements (2003 Western Weber General Plan, Page 2-14).

Zoning: The A-1 zone allows Cluster Subdivision Development. The Cluster ordinance allows for lot sizes as small as 9,000 square feet, as well as minimum lot width to be 60 feet. The proposal contains lots that range in size from .20 (9,000 square feet) to .48 acres.

Culinary water and sanitary sewage disposal: Feasibility letters have been provided for the culinary water and the sanitary sewer for the proposed subdivision. The culinary water will be provided by Taylor West Weber Water Improvement District. The sanitary sewage disposal will be provided by Central Weber Sewer Improvement District. The culinary water will-serve letter states that the applicant must provide pressurized secondary water to each lot. A condition of approval has been added to the staff recommendation that requires a final approval letter from Hooper Irrigation prior to receiving a recommendation for final approval from the Planning Commission.

Review Agencies: The subdivision application will be required to comply with all review agency requirements prior to receiving a final recommendation from the Planning Commission.

Additional Design Standards: Applicant is requesting 40% bonus density. This is allowed as the bonus density shall equal the gross acreage of the subdivision (40 acres). Applicant is dedicating 50% of net developable area as open space, to be used for grazing. Applicant will maintain individual ownership of open space. The applicant will be required to dedicate an open space easement

to the County so that the open space remains undeveloped in perpetuity. This can be done through the dedication language on the final subdivision plat. Applicant will provide additional information as to the open space preservation plan. This includes soil and irrigation information, including a will-serve letter.

The applicant is proposing a standard urban roadway cross section within the internal roads of the subdivision. This proposed cross section does not include curb and gutter, as such the planning commission can require a deferral agreement, in which the owner would be required to install curb and gutter at the time the county so requests.

As required by our land use code, the applicant will provide one street tree, of at least two-inch caliper, every 50 feet on both sides of the street. This comes out to approximately 56 trees along 1750 South, and 38 trees along 3800 West. A third requirement for granting bonus density is compliance with Ogden Valley Dark Sky Ordinance. All exterior lighting of homes in this subdivision shall comply with the requirements outlined in LUC 108-16. On the final improvement plans, the improved surface of the pathway within the subdivision, including along 1800 South, must be shown to be 10 feet wide.

Staff Recommendations

Staff recommends preliminary approval of Stagecoach Estates Cluster Subdivision consisting of 54 lots. This recommendation is based on all review agency requirements, including those outlined in this staff report, and following conditions:

1. A final approval letter, showing secured water shares, from Hooper Irrigation is required prior to receiving a recommendation for final approval from the Planning Commission.
2. On the final improvement plans, the improved surface of the pathway within the subdivision, including along 1800 South, must be shown to be 10 feet wide.

The recommendation is based on the following findings:

1. The proposed subdivision conforms to the West Central Weber General Plan.
2. The proposed subdivision complies with applicable county ordinances.

Exhibits

- A. Preliminary subdivision plat
- B. Application & Feasibility Letters

Area Map



Stagecoach Estates Acreage & Lot Summary

Acreages	acres	ft ²	No. Lots
Gross Development	40.00	1,742,400	
Street	3.31	144,184	
Net Developable	36.69	1,598,216	
Open Space	18.35	799,108	
Number 40KSF Lots ¹			39.96
Number Cluster Subdivision Lots ²			55.94

Notes:

1. Number 40KSF Lots= $((\text{Net Developable acreage}) * (43,560)) / (40,000)$

2. Number of Cluster Subdivision Lots=(Number of 40KSF Lots)(1.40)

Exhibit B- Application & Feasibility Letters

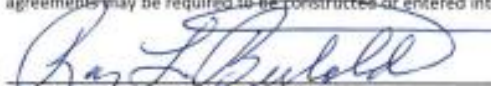
Weber County Subdivision Application			
<small>All subdivisions submittals will be accepted by appointment only. (801) 399-8791. 2380 Washington Blvd. Suite 240, Ogden, UT 84401</small>			
Date Submitted / Completed 2/10/2020	Fees (Office Use)	Receipt Number (Office Use)	File Number (Office Use)
Subdivision and Property Information			
Subdivision Name Stagecoach Estates		Number of Lots 56	
Approximate Address 1800 S 3800 W		Land Serial Number(s) 15-057-0006	
Current Zoning A-1	Total Acreage 40		
Culinary Water Provider	Secondary Water Provider Hooper Irrigation	Wastewater Treatment Weber Sewer district	
Property Owner Contact Information			
Name of Property Owner(s) Ray L. Bertoldi		Mailing Address of Property Owner(s) 1530 Church St. Layton, UT 84041	
Phone	Fax		
Email Address		Preferred Method of Written Correspondence Email Fax <input checked="" type="radio"/> Mail	
Authorized Representative Contact Information			
Name of Person Authorized to Represent the Property Owner(s) Patrick Burns		Mailing Address of Authorized Person 1407 N Mountain RD Ogden, UT 84404	
Phone 801-710-2234	Fax		
Email Address Pat@lynccconstruction.com		Preferred Method of Written Correspondence <input checked="" type="radio"/> Email Fax Mail	
Surveyor/Engineer Contact Information			
Name or Company of Surveyor/Engineer Terrex Engineering & Construction		Mailing Address of Surveyor/Engineer P.O. Box 13059 Ogden, UT 84412	
Phone 801-458-9647	Fax		
Email Address ehchristensen@terrexeng-const.com		Preferred Method of Written Correspondence <input checked="" type="radio"/> Email Fax Mail	
Property Owner Affidavit			
I (We), <u>Ray L. Bertoldi, Trustee</u> , depose and say that I (we) am (are) the owner(s) of the property identified in this application and that the statements herein contained, the information provided in the attached plans and other exhibits are in all respects true and correct to the best of my (our) knowledge. I (we) acknowledge that during the subdivision review process, it may be determined that additional requirements, covenants and/or agreements may be required to be constructed or entered into.			
 _____ (Property Owner)		_____ (Property Owner)	
Subscribed and sworn to me this <u>10th</u> day of <u>February</u> , 20 <u>20</u>			

TAYLOR WEST WEBER WATER IMPROVEMENT DISTRICT

2815 WEST 3300 SOUTH
WEST HAVEN, UTAH 84401

February 11, 2020

Weber County Planning Commission
2380 Washington Boulevard
Ogden, Utah 84401

To Whom It May Concern:

This is to inform you that *preliminary* approval has been given and the District has the capacity to provide culinary water only for 56 lots for Stagecoach Estates Subdivision at the approximate address of 3800 W. 1800 S. Taylor UT.

Requirements:

*Plan review fee=56 x \$25.00=\$1400.00

*Water rights fee = (\$4,363 per lot or current cost when paid) =\$243,936.00

*Secondary water = Must provide pressurized secondary water system to each lot.

*Connection /Impact fees will need to be paid by the lot owner at the time of building construction (Impact fee \$5,228 per lot (or current cost when paid).

*Cost for the water meter is \$375 plus \$100 for water use during construction.

*Adequate water lines must be installed to provide fire protection to the subdivision. The existing water line is 6" on 1800 South at this time, a 12" line must be installed from 3992 W. to 3688 W. on 1800 S. or from 3500 W. to 3912 W. on 1800 S. whichever is so desired by the developer. A 10" waterline needs to be installed on the street running North and South through the subdivision. All other lines may be 8".

*Taylor West Weber Water District reserves the right to make or revise changes as needed or as advised by the district engineer and the district attorney.

SUBDIVISION PERMITS SHOULD NOT BE ISSUED UNTIL FINAL APPROVAL IS GIVEN BY TAYLOR WEST WEBER WATER. Final approval is subject to meeting all of the requirements of the District having board approval and all fees being paid and received. This letter expires six months from the day it is issued.

Sincerely,  _____

TAYLOR WEST WEBER WATER IMP. DIST.

Ryan Rogers – Manager Expires 8/11/2020



PO Box 184	Phone: (801)985-8429
5375 S 5500 W	Fax: (801)985-3556
Hooper, Utah 84315	hooperirrigationco@msn.com

February 10, 2020

Weber County Planning Commission
2380 Washington Blvd, #240
Ogden, Utah 84401

RE: PRELIMINARY WILL SERVE LETTER – Stagecoach Subdivision

The development is located at 1800 South and 3800 West approximately and consists of 56 lots. Hooper Irrigation Company has pressure irrigation water available for the afore mentioned project located at the above address.

This letter states that the afore named project is in the boundaries of Hooper Irrigation Company. A formal application has been made to our office and the fee for application has been paid.

The subdivision plat plan has been reviewed by Hooper Irrigation. The preliminary plans have been conditionally approved for the above subdivision with some changes possibly needed. The issues of concern are the lack of any water shares with the property. The developer has assured Hooper Irrigation that he will purchase shares but at this time, there are no shares attached to this property for development. The developer will also be required to bring the water to him and run the lines in front of the property. Only this project is in consideration and guaranteed service and the plan review is good only for a period of one year from the date of this letter, if not constructed.

Hooper Irrigation's specifications are available at the Company office.

If you have questions, please call 801-985-8429.

Sincerely,



Central Weber Sewer Improvement District

February 11, 2020

Weber County Planning Commission
2380 Washington Blvd.
Ogden, Utah 84401-1473

Reference: Stagecoach Estates Subdivision
3800 West 1800 South
Sanitary Sewer Will Serve Letter

Weber County Planning Commission:

We have been asked review the possibility of providing sanitary sewer service for the proposed Stagecoach Estates Subdivision located at 3800 West 1800 South. This property is more or less described as a 40 Acre Parcel with Tax ID #15-057-0006. Central Weber Sewer Improvement District can accept and treat the sanitary sewer discharge from this location. The following conditions that must be met prior to any connections being made to the District's sanitary sewer line.

1. The nearest sanitary sewer line owned by Central Weber Sewer Improvement District is located at the intersection of 1800 S 4300 W.
2. If any sanitary sewer connections are made to the District's lines they will need to be designed and constructed according to the District's standard details and specifications. A copy of the District's details and specifications can be found at: <https://www.centralweber.com/information>.
3. The plans and details for any sanitary sewer connection into the District's collection system must be submitted to the District for review and approval. The District does not take the responsibility for the design of the collection system for the subdivision.
4. The District will not take ownership nor responsibility for ongoing maintenance and operation of the collection system within the Stagecoach Estates Subdivision nor the collection line from the subdivision to the connection point at 1800 South 4300 West.
5. The District must be notified for inspection at any time connections are being made to the District's sanitary sewer lines. The District will NOT install, own and/or maintain any of the sanitary sewer lines being extended to serve this property.

6. The connection of any sump pumps (or similar type pumps) to the sanitary sewer system is prohibited during or after construction. Central Weber's Wastewater Control Rules and Regulations state:

Prohibited Discharge into Sanitary Sewer. No person shall discharge or cause or make a connection which would allow to be discharged any storm water, surface water, groundwater, roof water runoff or subsurface drainage to any sanitary sewer.

7. Impact Fees for each residential lot must be paid prior to or at the time a building permit is obtained.

If you have further questions or need additional information please do not hesitate to contact us.

Sincerely,

CENTRAL WEBER SEWER IMPROVEMENT DISTRICT



Lance L. Wood, P. E.
General Manager

cc: Mandy Peterson, Lync Construction
pat@lynconstruction.com



Staff Report to the Western Weber Planning Commission

Weber County Planning Division

Synopsis

Application Information

Application Request:	Consideration and action on a request for preliminary approval of Halcyon Estates PRUD consisting of 39 lots located at approximately 4100 W 1800 S, Ogden.
Type of Decision:	Administrative
Agenda Date:	Tuesday, March 10, 2020
Applicant:	Tyler Brenchley, Keith Ward
File Number:	LVH 040419

Property Information

Approximate Address:	4100 W 1800 S
Project Area:	Approximately 31 acres
Zoning:	Agricultural (A-1) Zone
Existing Land Use:	Agricultural
Proposed Land Use:	Residential
Parcel ID:	15-057-0011, -0039
Township, Range, Section:	T6N, R2W, Section 21

Adjacent Land Use

North:	Agricultural	South:	Residential
East:	Residential	West:	Agricultural

Staff Information

Report Presenter:	Steve Burton sburton@co.weber.ut.us 801-399-8766
Report Reviewer:	RG

Applicable Ordinances

- Weber County Land Use Code Title 104 (Zones) Chapter 5, Agricultural (A-1 Zone)
- Weber County Land Use Code Title 106 (Subdivisions)

Background and Summary

The applicant is requesting preliminary approval of Halcyon Estates PRUD subdivision consisting of 39 lots, located at approximately 4100 W 1800 S, Ogden. The PRUD received a recommendation for conditional use permit approval from the Western Weber Planning Commission on February 11, 2020. The County Commission approved the conditional use permit on March 10, 2020. The platting of the subdivision is the final step in the PRUD process.

Analysis

General Plan: The proposal conforms to the Western Weber General Plan by preserving agricultural open space with open space easements (2003 Western Weber General Plan, Page 2-14).

Zoning: The A-1 zone conditionally allows Planned Residential Unit Developments. Although the proposed lot sizes are smaller than otherwise allowed by the A-1 zone, the platting of the lots is in conformance with the approved site plan provided as part of conditional use permit approval.

Culinary water and sanitary sewage disposal: Feasibility letters have been provided for the culinary water and the sanitary sewer for the proposed subdivision. The culinary water will be provided by Taylor West Weber Water Improvement District. The sanitary sewage disposal will be provided by Central Weber Sewer Improvement District. The culinary water will-serve letter states that the applicant must provide pressurized secondary water to each lot. A condition of approval has been added to the staff recommendation that requires an approval letter from Hooper Irrigation prior to receiving a recommendation for final approval from the Planning Commission.

Review Agencies: The subdivision application will be required to comply with all review agency requirements prior to receiving a final recommendation from the Planning Commission.

Additional Design Standards: The applicant is requesting to enter into a deferral agreement for curb, gutter, and sidewalk along 1700 S and 4075 West streets.

Staff Recommendations

Staff recommends preliminary approval of Halcyon Estates PRUD Subdivision consisting of 39 lots. This recommendation is based on the review agency requirements and following condition:

1. A deferral agreements for curb, gutter, and sidewalk will be required along 1700 S and 4075 West streets prior to recording the final mylar.
2. An approval letter from Hooper Irrigation is required prior to receiving a recommendation for final approval from the Planning Commission.

The recommendation is based on the following findings:

1. The proposed subdivision conforms to the West Central Weber General Plan.
2. The proposed subdivision complies with applicable county ordinances.

Exhibits

- A. Preliminary subdivision plan
- B. Approved PRUD site plan

Area Map

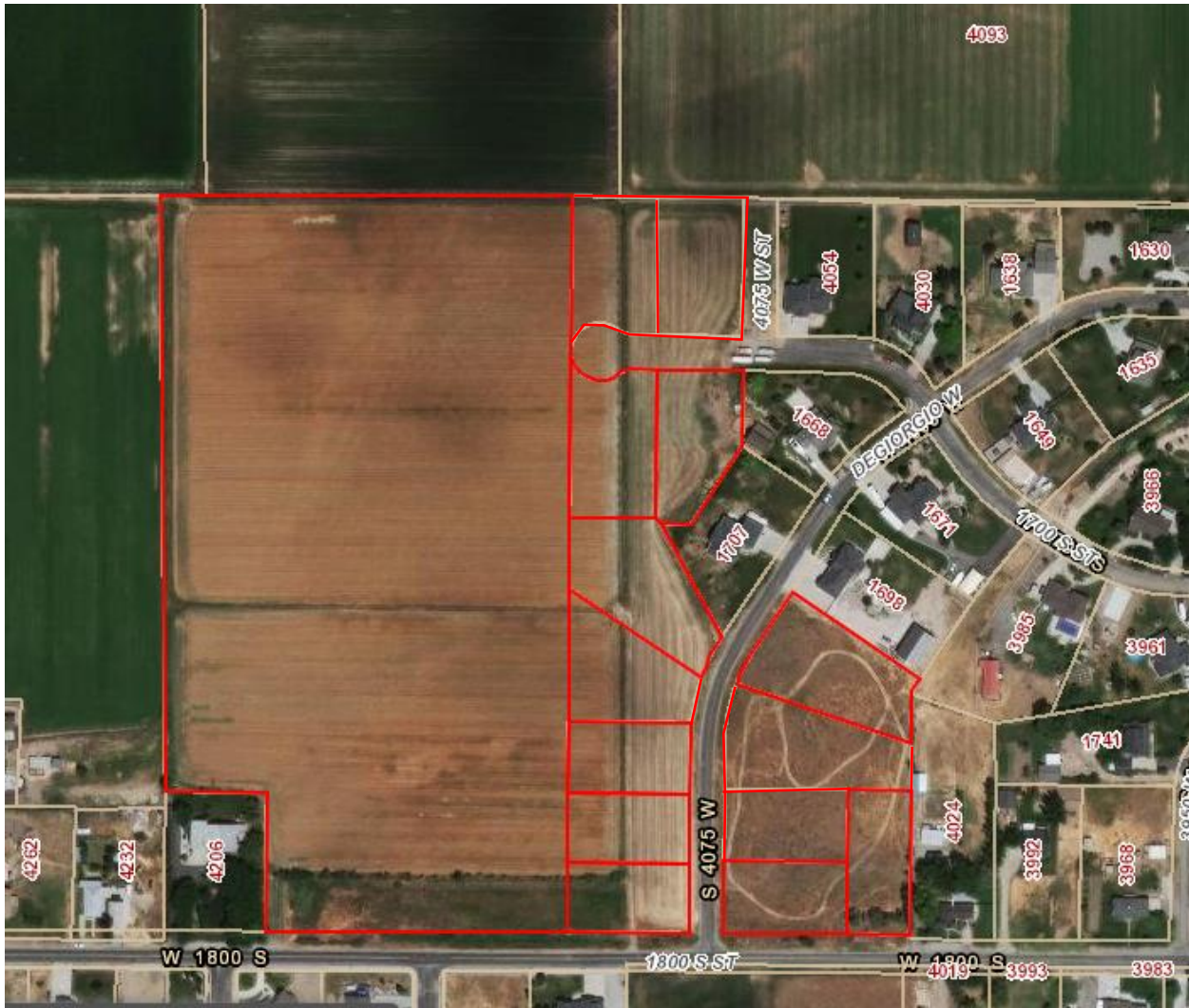

HALCYON ESTATES

"A PRUD SUBDIVISION"

LOCATED IN THE SW 1/4 OF SECTION 21, T.6N R.2W
SALT LAKE BASE & MERIDIAN
WEBER COUNTY, UT
JANUARY, 2020

DESIGN DATA
TOTAL AREA: 31.68 AC
LOT AREA: 27.92 AC
R.O.W AREA: 3.76 AC
ZONE: A1
AVG LOT WIDTH: 125.8'
AVG LOT SIZE: 30,408.6'

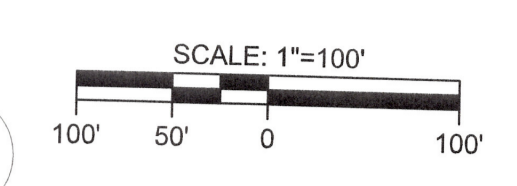

PREPARER
WRB Consulting Services
521 West 1050 South
PO Box 1117
Salem, UT 84653

(801) 360-6297
bruceward007@live.com

CONSULTANTS

**PRELIMINARY
NOT FOR
CONSTRUCTION**

PROJECT INFO
HALCYON ESTATES
A PORTION OF THE SW 1/4 OF SECTION 21, T.6N R.2W SALT LAKE BASE & MERIDIAN WEBER COUNTY, UTAH
"A PRUD SUBDIVISION"

OWNER
WAKELESS HOLDINGS LLC

TYLER BRENCHLEY
1064 SPYGLASS HILL
SYRACUSE, UT 84075
(801) 644-3148
tylorbranchley@gmail.com
and
KEITH WARD
1978 CAMERON DRIVE
WEST HAVEN, UT 84401
(801) 540-9399
wardkr1@msn.com

REVISIONS/SUBMISSIONS
PRE 1/6/2020 PRELIMINARY PLAT

MARK DATE DESCRIPTION
PROJECT # 201901
CAD DWG FILE: 201901-C-SP.dwg
DRAWN BY: JST
CHECKED BY: DSS
DESIGNED BY: BW
SHEET TITLE

**PRELIMINARY
PLAT
UTILITY PLAN**

SHEET NAME
PP-01
SHEET 1 OF 2

LEGEND

PROPERTY

- BOUNDARY LINE
- CENTERLINE
- RIGHT-OF-WAY LINE
- LOT LINE
- SECTION LINE
- EASEMENT LINE
- SETBACK LINE

UTILITIES

- SD STORM DRAINAGE LINE
- SS SANITARY SEWER LINE
- W WATER LINE
- E ELECTRIC LINE
- G NATURAL GAS LINE
- IRR IRRIGATION LINE

SYMBOLS

- ⊙ FIRE HYDRANT
- ⊙ SANITARY SEWER MANHOLE
- ⊙ STORM DRAIN MANHOLE
- ⊙ WATER VALVE
- ⊙ IRRIGATION STRUCTURE

CURVE TABLE

NO.	DELTA	RADIUS	LENGTH
C1	21°26'08"	268.82'	100.57'
C2	11°42'46"	268.82'	54.95'
C3	13°58'36"	328.80'	80.21'
C4	13°58'33"	328.80'	80.20'
C5	5°11'54"	328.80'	29.83'
C6	131°09'19"	50.00'	114.45'
C7	131°24'32"	50.00'	114.68'
C8	41°24'35"	30.00'	21.68'
C9	41°24'35"	30.00'	21.68'
C10	43°00'09"	62.00'	46.53'
C11	41°41'30"	62.00'	45.11'
C12	89°38'49"	62.00'	97.01'
C13	41°24'08"	30.01'	21.68'
C14	131°24'32"	50.00'	114.68'
C15	131°24'31"	50.00'	114.68'
C16	5°36'31"	30.00'	2.94'
C17	35°48'01"	30.00'	18.75'
C18	5°20'21"	62.00'	5.78'

LINE TABLE

NO.	BEARING	LENGTH
L1	S34°01'02"W	27.01'
L2	S34°01'02"W	130.43'
L3	N55°58'58"W	60.00'
L4	S89°02'21"E	53.00'
L5	S89°02'25"E	57.93'
L6	S36°23'21"E	13.08'
L7	S00°49'59"W	2.95'

LOT SUMMARY TABLE

LOT #	WIDTH	AREA (SF)
LOT 1	148.97'	34562.87'
LOT 2	148.97'	35603.09'
LOT 3	150.00'	33933.68'
LOT 4	150.00'	37474.77'
LOT 5	80.21'	42951.98'
LOT 6	80.20'	34873.08'
LOT 7	124.47'	26519.67'
LOT 8	120.00'	25566.78'
LOT 9	120.00'	25557.88'
LOT 10	125.00'	26874.63'
LOT 11	125.00'	26875.00'
LOT 12	174.16'	43075.10'
LOT 13	177.50'	42804.12'
LOT 14	110.00'	27500.75'
LOT 15	121.82'	14650.50'
LOT 16	100.00'	12000.00'
LOT 17	100.00'	12000.00'
LOT 18	100.00'	12000.00'
LOT 19	100.00'	12000.00'
LOT 20	80.00'	9600.00'
LOT 21	80.00'	9600.00'
LOT 22	80.00'	9600.00'
LOT 23	80.00'	9600.00'
LOT 24	80.00'	9600.00'
LOT 25	80.01'	9600.51'
LOT 26	46.53'	16077.27'
LOT 27	73.14'	16716.82'
LOT 28	125.70'	15083.43'
LOT 29	161.83'	15940.84'
LOT 30	89.12'	12420.04'
LOT 31	88.12'	12441.92'
LOT 32	88.12'	12447.71'
LOT 33	117.62'	11588.93'
LOT 34	136.36'	17865.08'
LOT 35	121.54'	14552.71'
LOT 36	100.00'	11999.99'
LOT 37	100.00'	11999.99'
LOT 38	100.00'	12000.00'
LOT 39	100.00'	12000.00'
LOT AG	649.20'	435595.37'

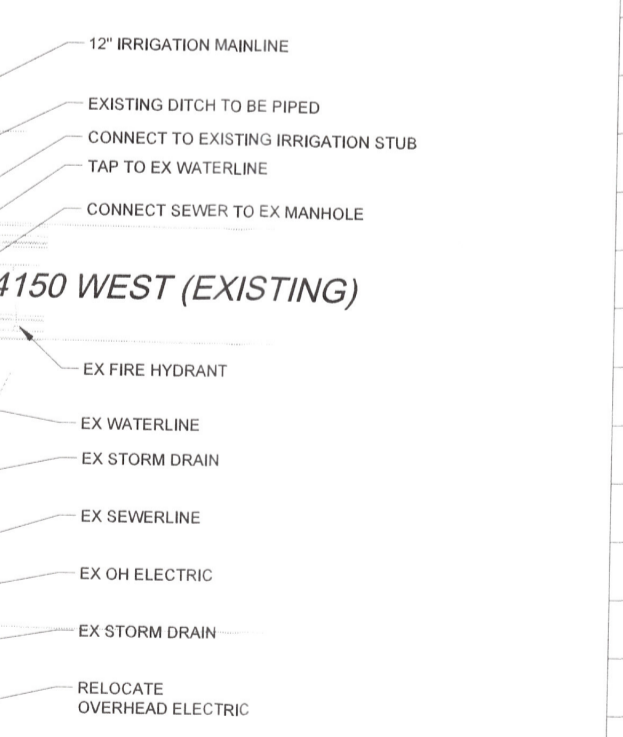
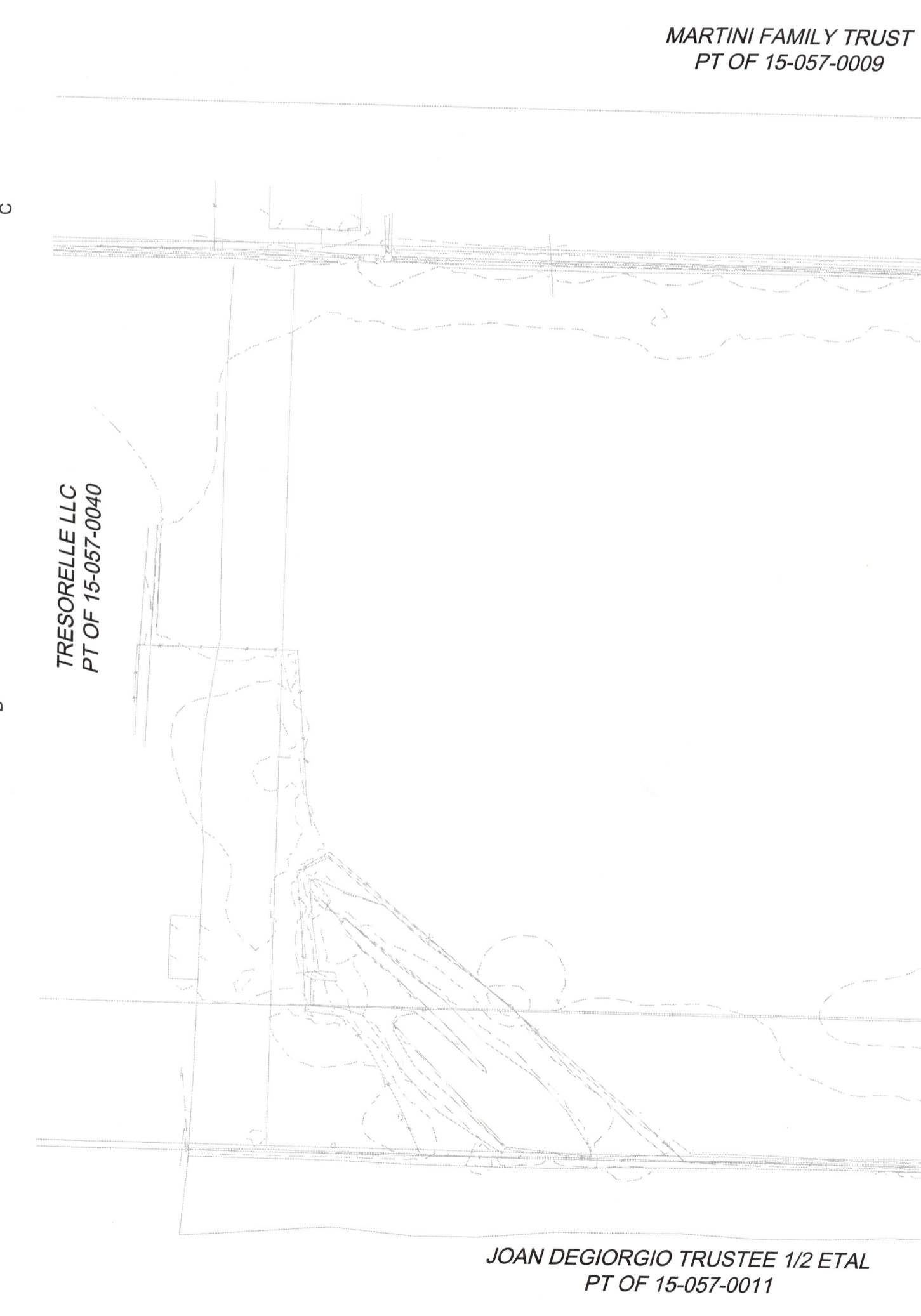
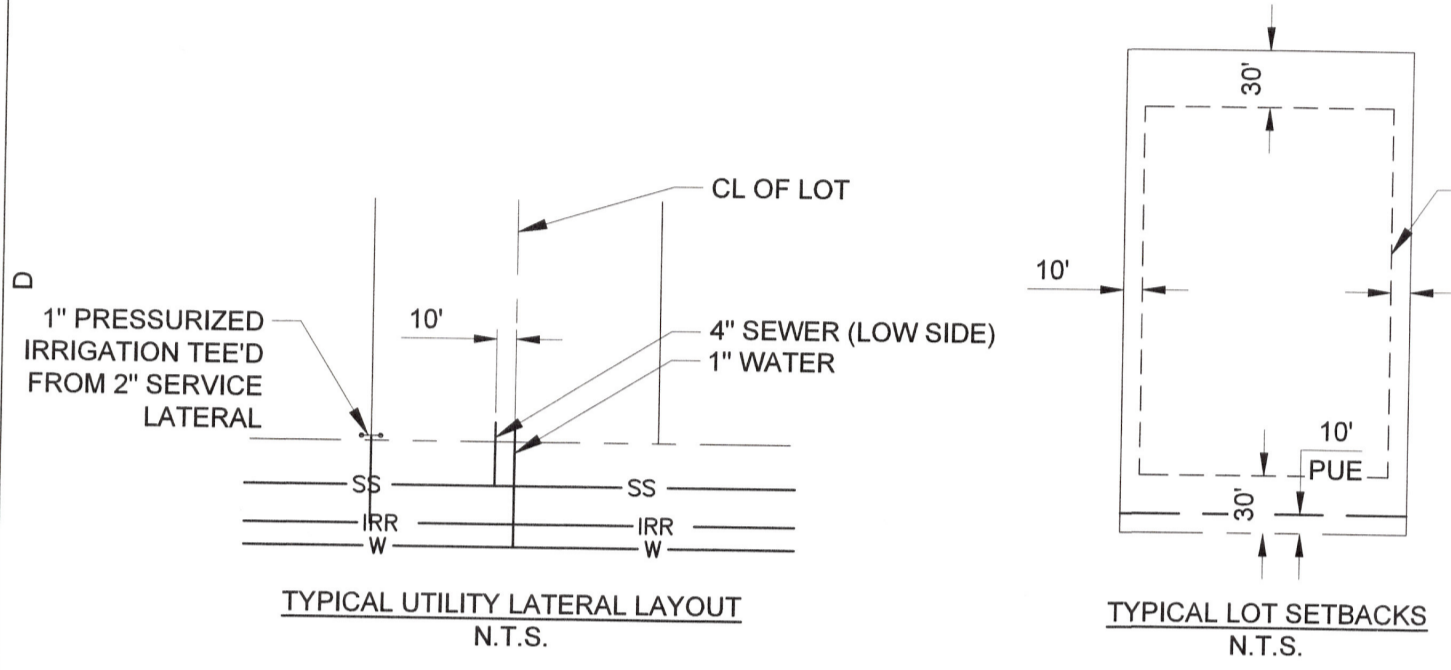

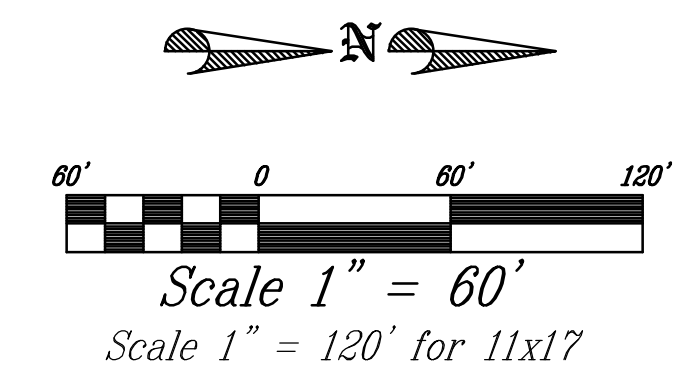

LAND USE CALCS

# OF RESIDENTIAL LOTS	39	AREA OF RESIDENTIAL LOTS PH. 1	12.15 ACRES
# OF AGRICULTURE LOTS	1	AREA OF RESIDENTIAL LOTS PH. 2	9.54 ACRES
TOTAL # OF LOTS	40	AREA OF AGRICULTURE LOT	10.00 ACRES
		TOTAL AREA	31.69 ACRES

LENGTH OF ROADS	3,096 LF
REQUIRED TREES (8/100 LF ROAD)	248 TREES
PROPOSED TREES	173 TREES

*STREET TREES ARE SPACED 25' O.C.

If a PRUD provides and implements an approved roadway landscape and design plan that includes, but is not necessarily limited to, vehicle and pedestrian circulation, lighting, and street trees of an appropriate species, size of at least a two-inch caliper, and quantity of not less than eight trees for every 100 feet of road length, up to 20 percent bonus density may be granted.

PLANT SCHEDULE

TREES	QTY	COMMON / BOTANICAL NAME	CONT	CAL
	104	Autumn Blaze Maple / Acer freemanii 'Autumn Blaze'	B&B	2" Cal
	31	Littleleaf Linden / Tilia cordata	B&B	2" Cal
	59	Shademaster Locust / Gleditsia triacanthos inermis 'Shademaster'™	B&B	2" Cal

WEBER
HALCYON ESTATES

SITE PLAN

380 E Main St, Suite 204
Midway, Ut 84049 ph. (801) 723-2000

DESIGN BY: CNB	DATE: 3 MAR 2020	SHEET
DRAWN BY: CNB	REV:	L1



Staff Report to the Western Weber Planning Commission

Weber County Planning Division

Synopsis

Application Information

Application Request:	Public hearing to discuss and take comment on a proposal to amend the following sections of Weber County Code: §101-1-7 and §108-7 to add a definition of agricultural building, amend the definition of agricultural parcel, and include provisions for agricultural building exemptions.
Agenda Date:	Tuesday, March 10, 2020
Applicant:	Weber County Planning Division
File Number:	ZTA 2019-01

Staff Information

Report Presenter:	Steve Burton sburton@co.weber.ut.us 801-399-8766
Report Reviewer:	CE

Applicable Ordinances

- Weber County Land Use Code, Title 101, Chapter 1 (Definitions).
- Weber County Land Use Code, Title 108, Chapter 7 (Supplementary and Qualifying Regulations).

Legislative Decisions

Decision on this item is a legislative action. When the Planning Commission is acting on a legislative item it is acting as a recommending body to the County Commission. Legislative decisions have wide discretion. Examples of legislative actions are general plan, zoning map, and land use code amendments. Typically, the criterion for providing a recommendation on a legislative matter suggests a review for compatibility with the general plan and existing ordinances.

Summary and Background

The current Uniform Land Use Code of Weber County, Utah (LUC) defines the term "Agricultural Parcel" as follows:

Agricultural parcel. The term "agricultural parcel" means a single parcel of land, at least five acres in area if vacant, or five and one-quarter acres with a residential dwelling unit. This definition needs to be fulfilled in order to qualify for the agricultural building exemption.

In order to remove regulation from the definition, the county is proposing to eliminate the last sentence of the existing definition. A definition for the term "agricultural building" is also being proposed so that a new section (see exhibit A) can regulate exemptions for agricultural buildings. The proposed amendments to the land use code will ensure that the county's regulations conform to the state regulations regarding agricultural building exemptions.

Conformance to the General Plan

This proposal conforms to the goals of the West Central Weber County General Plan, including the protection of rural character, lifestyle, and atmosphere (West Central Weber County General Plan Vision Statement, pg 1-6).

Past Action on this Item

No action has occurred on this item.

Noticing Compliance

A hearing for this item was published in compliance with UCA §17-27a-205 and UCA §17-27a-502 in the following manners:

Posted on the County's Official Website

Posted on the Utah Public Notice Website

Published in a local newspaper

Staff Recommendation

Staff recommends that the Western Weber Planning Commission recommend approval of the text included as Exhibit A of this staff report based on the following findings:

1. The changes cause no adverse effect on the intent of the general plans.
2. The clarifications will provide for a more efficient administration of the Land Use Code.
3. The changes will enhance the general welfare of County residents.

Exhibits

- A. Proposed Ordinance – Clean Copy.
- B. Proposed Ordinance – Track Change Copy.

1
2
3
4
5
6
7
8
9
10
11
12
13
14
15
16
17
18
19
20
21
22
23
24
25

Part II - Land Use Code

Title 101 - General Provisions

• **Sec. 101-1-7. - Definitions**

Agricultural parcel. The term "agricultural parcel" means a single parcel of land, at least five acres in area if vacant, or five and one-quarter acres with a residential dwelling unit.

Agricultural building. The term "agricultural building" means a structure used solely in conjunction with on-site agricultural use.

...

Title 108 - Standards

Chapter 7.- Supplementary and Qualifying Regulations

...

• **Sec. 108-7-34 - Agricultural Building Exemption**

Agricultural buildings are exempt from the permit requirements of the state construction codes, except plumbing, electrical, and mechanical permits may be required when that work is included in the structure.

1
2
3
4
5
6
7
8
9
10
11
12
13
14
15
16
17
18
19
20
21
22
23
24
25
26

Part II - Land Use Code

Title 101 - General Provisions

- **Sec. 101-1-7. - Definitions**

Agricultural parcel. The term "agricultural parcel" means a single parcel of land, at least five acres in area if vacant, or five and one-quarter acres with a residential dwelling unit. ~~This definition needs to be fulfilled in order to qualify for the agricultural building exemption.~~

Agricultural building. The term "agricultural building" means a structure used solely in conjunction with on-site agricultural use.

...

Title 108 - Standards

Chapter 7.- Supplementary and Qualifying Regulations

...

- [Sec. 108-7-34 - Agricultural Building Exemption](#)

Agricultural buildings are exempt from the permit requirements of the state construction codes, except plumbing, electrical, and mechanical permits may be required when that work is included in the structure.