

SWPPP for North View Holdings LLC

Instructions to the Contractor:

Please familiarize yourself with the SWPPP document and fill in blanks with additional information such as Operator/Contact/ Manager names, phone numbers and e-mails, as well as start/end dates, training personnel, and any other needed information throughout the document. Please place a copy of the Material Safety Data Sheets in Appendix C. Please submit an NOI and include a copy of the letter from the state notifying you of their receipt of your complete NOI/application in Appendix D. Fill in information in the appropriate location on page 4 of this document now and any time there are revisions to the document. Owner / Operator / Professional Certifications, found in Section 8, all include the same verbiage and are required by the State of Utah. The Engineer has signed the Professional Certification. If multiple Operators are used, please make additional copies of the Operator Certification so that all may sign.

Please place this page in appendix D after completing the above items.

Stormwater Pollution Prevention Plan

for:

North View Holdings LLC
Approx. 2700 North Highway 89
Weber County, Utah 84404
Phone: _____

Operator(s):

Name: _____
Address: _____

Phone: _____
Fax: _____

SWPPP Contact(s):

Name: _____
Address: _____

Phone: _____
Fax: _____
Email: _____

SWPPP Preparation Date:

2 / 8 / 2013

Estimated Project Dates:

Project Start Date: _/ _/ _
Project Completion Date: _/ _/ _

Contents

SECTION 1: SITE EVALUATION, ASSESSMENT, AND PLANNING	1
1.1 Project/Site Information.....	1
1.2 Contact Information/Responsible Parties	1
1.3 Nature and Sequence of Construction Activity.....	4
1.4 Soils, Slopes, Vegetation, and Current Drainage Patterns.....	5
1.5 Construction Site Estimates	5
1.6 Receiving Waters.....	5
1.7 Site Features and Sensitive Areas to be Protected	6
1.8 Potential Sources of Pollution.....	6
1.9 Endangered Species Certification.....	7
1.10 Historic Preservation	7
1.11 Applicable Federal, Tribal, State or Local Programs	7
1.12 Maps	7
SECTION 2: EROSION AND SEDIMENT CONTROL BMPs	8
2.1 Minimize Disturbed Area and Protect Natural Features and Soil.....	8
2.2 Phase Construction Activity.....	8
2.3 Control Stormwater Flowing onto and through the Project.....	8
2.4 Stabilize Soils.....	8
2.5 Protect Slopes.....	9
2.6 Protect Storm Drain Inlets.....	9
2.7 Establish Perimeter Controls and Sediment Barriers	9
2.8 Retain Sediment On-Site.....	10
2.9 Establish Stabilized Construction Exits.....	10
2.10 Additional BMPs (Not Selected, But Available For Use).....	10
SECTION 3: GOOD HOUSEKEEPING BMPs	13
3.1 Material Handling and Waste Management.....	13
3.2 Establish Proper Building Material Staging Areas.....	13
3.3 Designate Washout Areas.....	13
3.4 Establish Proper Equipment/Vehicle Fueling and Maintenance Practices.....	14
3.5 Control Equipment/Vehicle Washing.....	14
3.6 Spill Prevention and Control Plan	14
3.7 Any Additional BMPs	14
3.8 Allowable Non-Stormwater Discharge Management.....	15
SECTION 4: SELECTING POST-CONSTRUCTION BMPs	16
SECTION 5: INSPECTIONS.....	16
5.1 Inspections	16
5.2 Delegation of Authority.....	17
5.3 Corrective Action Log.....	17
SECTION 6: RECORDKEEPING AND TRAINING	17
6.1 Recordkeeping.....	17
6.2 Log of Changes to the SWPPP.....	17
6.3 Training.....	18

SECTION 7: FINAL STABILIZATION.....	18
SECTION 8: CERTIFICATION AND NOTIFICATION.....	19
SWPPP DRAWINGS AND APPENDICES	23
Drawings – General Location Map (Site Maps located in back cover)	
Appendix A – Construction General Permit	
Appendix B – Standards and Specifications For Selected BMP's	
Appendix C – Material Safety Data Sheets	
Appendix D – Blank Forms	
Appendix E –Additional Non-Selected BMP's	

SECTION 1: SITE EVALUATION, ASSESSMENT, AND PLANNING

1.1 Project/Site Information

Project/Site Name: North View Holdings LLC

Project Street/Location: Approx. 2700 North Highway 89

City: N/A

State: Utah ZIP Code: 84404

County or Similar Subdivision: Weber County

Latitude/Longitude (Use **one** of three possible formats, and specify method)

Latitude:

Longitude:

1. ___ ° ___ ' ___ " N (degrees, minutes, seconds)

1. ___ ° ___ ' ___ " W (degrees, minutes, seconds)

2. ___ ° ___ . ___ ' N (degrees, minutes, decimal)

2. ___ ° ___ . ___ ' W (degrees, minutes, decimal)

3. 41.309 ° N (decimal)

3. 112.009° W (decimal)

Method for determining latitude/longitude:

USGS topographic map (specify scale: _____)

EPA Web site GPS

Other (please specify): Google Earth

Is the project located in Indian country? Yes No

If yes, name of Reservation, or if not part of a Reservation, indicate "not applicable." _____

Not applicable

Is this project considered a federal facility? Yes No

NPDES project or permit tracking number*:

**(This is the unique identifying number assigned to your project by your permitting authority after you have applied for coverage under the appropriate National Pollutant Discharge Elimination System (NPDES) construction general permit.)*

1.2 Contact Information/Responsible Parties

Operator(s):

Name: _____

Address: _____

Phone: _____

Fax: _____

Project Manager(s) or Site Supervisor(s):

Name: _____

Address: _____

Phone: _____

Fax: _____

SWPPP Contact(s):

Name: _____

Address: _____

Phone: _____

Fax: _____

Email: _____

This SWPPP was Prepared by:

Great Basin Engineering

Ryan Bingham

5746 S 1475 E Ste. 200

Ogden, UT 84403

801-394-4515

801-392-7544

Emergency 24-Hour Contact:

Company: _____

Name: _____

Phone: _____

Revision Schedule

This storm water pollution prevention plan (SWPPP) should be revised and updated to address changes in site conditions, new or revised government regulations, and additional on-site storm water pollution controls.

All revisions to the SWPPP must be documented on the SWPPP Revision Documentation Form, which should include the information shown below. The authorized project representative who approves the SWPPP should be an individual at or near the top of the project's management organization, such as the president, vice president, construction manager, site supervisor, or environmental manager. The signature of this representative attests that the SWPPP revision information is true and accurate. Previous authors and project representatives are not responsible for the revisions.

SWPPP Revision Documentation Form

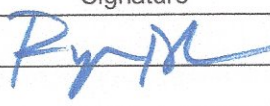
Number	Date	Author	Company Representative Signature
0	2/8/13	Ryan Bingham	
1			
2			
3			
4			
5			
6			
7			
8			
9			
10			

1.3 Nature and Sequence of Construction Activity

Describe the general scope of the work for the project, major phases of construction, etc:
 Construction of a Medical Building and Parking lots/drive aisles. Construction of sidewalk, curb and gutter, landscaping, and other surface improvements. Underground utilities such as sewer, storm drain and waterlines will be implemented with this project.

What is the function of the construction activity?

- Residential
 Commercial
 Industrial
 Road Construction
 Linear Utility
 Other (please specify):

Estimated Project Start Date:

Estimated Project Completion Date:

--/ /--
 --/ /--

1.4 Soils, Slopes, Vegetation, and Current Drainage Patterns

Soil type(s):

The site consists predominantly of Logan silty clay loam, saline, sodic, 0 to 1 percent slopes and Harrisville-Leland complex, 0 to 1 percent slopes. This information was taken from the NRCS USDA SCS Service website at <http://websoilsurvey.nrcs.usda.gov/app/WebSoilSurvey.aspx>.

Slopes

The existing site slopes to the west in general. The east half of the site is relatively steeper than the west half at around 10 %. The west half has a gentle slope to the west of about 1% or less. In the proposed conditions, slopes in the parking lots will be between 1.5% and 4.5%. The surrounding grass landscaping will be graded a little steeper in general at around 10% with landscaping in the islands in the parking areas sloped at about 2%.

Drainage Patterns

Existing drainage is generally toward the west in general as mentioned. It proceeds to the southwest corner of the site, where it is intercepted by a 12" pipe, which flows to the west. Proposed conditions have drainage towards inlet boxes and catch basins located throughout the parking lots and drive aisles. Storm water then continues to a proposed detention facility located in the west parking lot. Post orifice flows will continue to the aforementioned 12" pipe and continue to the west in a historical fashion. See grading and utility plans for more information.

Vegetation:

The existing site has native grasses and vegetation. The entire site will be cleared and grubbed. Landscaping adjacent to the site is to be preserved. (See the site map in the appendix).

Other:

N/A

1.5 Construction Site Estimates

The following are estimates of the construction site.

Total project area:	1.90 acres
Construction site area to be disturbed:	1.90 acres
Percentage impervious area before construction:	5%
Runoff coefficient before construction:	0.19
Percentage impervious area after construction:	68%
Runoff coefficient after construction:	0.66

1.6 Receiving Waters

Description of receiving waters:

Drainage from the site will be released from the detention facility to an existing 12” storm drain at the southwest corner of the site and will continue to the west to a regional detention pond downstream and proceed in that system in a historical fashion. It is ultimately intercepted by a canal that drains to Willard Bay to the northwest.

Description of storm sewer systems:

Storm drain pipes for this development are proposed to be PVC (polyvinyl chloride) and/or CP (concrete pipe).

Description of impaired waters or waters subject to TMDLs:

N/A

1.7 Site Features and Sensitive Areas to be Protected

Description of unique features that are to be preserved:

The entire site will be cleared and grubbed. No onsite features are to be preserved. Native landscaping adjacent to the site, however, should be preserved.

Describe measures to protect these features:

N/A.

1.8 Potential Sources of Pollution

Potential sources of sediment to stormwater runoff:

Most of the existing site is unpaved and is a potential source of sediment from storm water runoff. Proposed conditions consist of a medical building with parking areas, surface improvements, and underground utilities.

Potential pollutants and sources, other than sediment, to stormwater runoff:

Fuels, Engine Fluids from Vehicles, and Dust, are potential pollutants and sources

Trade Name Material	Stormwater Pollutants	Location
Fuels and Oils	Gasoline, Oil	Entire Site
Soil Erosion	Sediments	Entire site

1.9 Endangered Species Certification

Are endangered or threatened species and critical habitats on or near the project area?

Yes No

Describe how this determination was made:

A search of http://dwrcdc.nr.utah.gov/ucdc/viewreports/te_cnty.pdf yielded was made and yielded only the Ute-Ladies'-tresses, June Sucker, and Gray Wolf as either threatened or endangered in the Weber County Area. Ute-Ladies' Tresses occurs along riparian edges, gravel bars, old oxbows, high flow channels, and moist to wet meadows along perennial streams. It typically occurs in stable wetland and seepy areas associated with old landscape features within historical floodplains of major rivers according to fws.gov. The site does not have these characteristics. The June Sucker is a fish and is endemic to Utah Lake and the Provo River. The site is in an area adjacent to Highway 89 with no evidence of the Gray Wolf. This site, therefore, does not have any threatened or endangered species.

1.10 Historic Preservation

Are there any historic sites on or near the construction site?

Yes No

Describe how this determination was made:

A search of the National Register of Historic Places was made and gives no historical sites within a mile of the project location.

1.11 Applicable Federal, Tribal, State or Local Programs

N/A

1.12 Maps

A Site Map is included with the SWPPP.

SECTION 2: EROSION AND SEDIMENT CONTROL BMPS

2.1 *Minimize Disturbed Area and Protect Natural Features and Soil*

Topsoil will be preserved by using BMP's such as Silt Fence, Inlet Protection, Dust Controls, and Stabilized Construction Entrance.

2.2 *Phase Construction Activity*

Construction consists of clearing and grubbing, construction of underground utilities, construction of asphalt parking areas, sidewalk, and curb and gutter, construction of a medical office building, and landscaping.

2.3 *Control Stormwater Flowing onto and through the Project*

The site will not have a significant amount of stormwater run-on as it is bordered on the east by Highway 89. The site slopes to the west in general. Other adjacent ground also tends to be sloped to the west in general. If any storm water does run on to the site, it will be treated with the same BMP's as stormwater falling directly on the site. As mentioned previously, the site generally drains gently to the west. Runon is anticipated to be very minimal in general.

2.4 *Stabilize Soils*

BMP Description: Dust Controls (See Appendix B For Details)

<i>Installation Schedule:</i>	Use regularly as needed to prevent dust from leaving the site in the air.
<i>Maintenance and Inspection:</i>	Weekly and as needed, ensure equipment used for dust controls is functioning properly. Inspect site weekly for areas of dust concern, and promptly utilize BMP DC as needed.
<i>Responsible Staff:</i>	Provided by Contractor

BMP Description: Seeding and Planting (See Appendix B For Details)

<i>Installation Schedule:</i>	Provided by Landscaper
<i>Maintenance and Inspection:</i>	Adequate watering and fertilization shall be used. Grass shall be watered and mowed.
<i>Responsible Staff:</i>	Provided by Contractor

2.5 Protect Slopes

BMP Description: Seeding and Planting (See Appendix B For Details)

Installation Schedule:	Provided by Landscaper
Maintenance and Inspection:	Adequate watering and fertilization shall be used. Grass shall be watered and mowed.
Responsible Staff:	Provided by Contractor

BMP Description: Preservation of Existing Vegetation (See Appendix B For Details)

Installation Schedule:	Before construction or earthwork begins.
Maintenance and Inspection:	Maintenance requirements are low.
Responsible Staff:	Provided by Contractor

2.6 Protect Storm Drain Inlets

BMP Description: Inlet Protection – Gravel or Concrete Block are the recommended choices (See Appendix B For Details)

Installation Schedule:	Use on Existing Inlets before any earthwork is done and on new inlets as soon as they are installed
Maintenance and Inspection:	Inspect after every large storm and remove sediment buildup as required. Replace filter fabric if clogged.
Responsible Staff:	Provided by Contractor

2.7 Establish Perimeter Controls and Sediment Barriers

BMP Description: Silt Fence (See Appendix B For Details)

Installation Schedule:	Install before any soil disturbance occurs.
Maintenance and Inspection:	Inspect immediately after any rainfall. Look for bypassing or undercutting and repair as required. Remove sediment that reaches one-half fence height.
Responsible Staff:	Provided by Contractor

2.8 Retain Sediment On-Site

<i>BMP Description: Silt Fence (See Appendix B For Details)</i>	
<i>Installation Schedule:</i>	Install before any soil disturbance occurs.
<i>Maintenance and Inspection:</i>	Inspect immediately after any rainfall. Look for bypassing or undercutting and repair as required. Remove sediment that reaches one-half fence height.
<i>Responsible Staff:</i>	Provided by Contractor

<i>BMP Description: Stabilized Construction Entrance (See Appendix B For Details)</i>	
<i>Installation Schedule:</i>	Install before any construction vehicles leave the site
<i>Maintenance and Inspection:</i>	Inspect entrance and adjacent roadway daily for sediment buildup and loss of gravel. Repair as required.
<i>Responsible Staff:</i>	Provided by Contractor

2.9 Establish Stabilized Construction Exits

<i>BMP Description: Stabilized Construction Entrance (See Appendix B For Details)</i>	
<i>Installation Schedule:</i>	Install before any construction vehicles leave the site
<i>Maintenance and Inspection:</i>	Inspect entrance and adjacent roadway daily for sediment buildup and loss of gravel. Repair as required.
<i>Responsible Staff:</i>	Provided by Contractor

2.10 Additional BMPs (Not Selected, But Available For Use)

<i>BMP Description: Bioengineering (See Appendix E For Details)</i>	
<i>Installation Schedule:</i>	Provided by Contractor
<i>Maintenance and Inspection:</i>	See BMP BIO in Appendix E
<i>Responsible Staff:</i>	Provided by Contractor

<i>BMP Description: Brush or Rock Filter (See Appendix E For Details)</i>	
<i>Installation Schedule:</i>	Provided by Contractor
<i>Maintenance and Inspection:</i>	See BMP FS in Appendix E
<i>Responsible Staff:</i>	Provided by Contractor
<i>BMP Description: Chemical Mulch (See Appendix E For Details)</i>	
<i>Installation Schedule:</i>	Provided by Contractor
<i>Maintenance and Inspection:</i>	See BMP CM in Appendix E
<i>Responsible Staff:</i>	Provided by Contractor
<i>BMP Description: Compaction (See Appendix E For Details)</i>	
<i>Installation Schedule:</i>	Provided by Contractor
<i>Maintenance and Inspection:</i>	See BMP CP in Appendix E
<i>Responsible Staff:</i>	Provided by Contractor
<i>BMP Description: Diversion Dike (See Appendix E For Details)</i>	
<i>Installation Schedule:</i>	Provided by Contractor
<i>Maintenance and Inspection:</i>	See BMP DD in Appendix E
<i>Responsible Staff:</i>	Provided by Contractor
<i>BMP Description: Earth Berm Barrier (See Appendix E For Details)</i>	
<i>Installation Schedule:</i>	Provided by Contractor
<i>Maintenance and Inspection:</i>	See BMP EBB in Appendix E
<i>Responsible Staff:</i>	Provided by Contractor
<i>BMP Description: Filter Strips (See Appendix E For Details)</i>	
<i>Installation Schedule:</i>	Provided by Contractor
<i>Maintenance and Inspection:</i>	See BMP FS in Appendix E
<i>Responsible Staff:</i>	Provided by Contractor

<i>BMP Description: Hydromulching (See Appendix E For Details)</i>	
<i>Installation Schedule:</i>	Provided by Contractor
<i>Maintenance and Inspection:</i>	See BMP HM in Appendix E
<i>Responsible Staff:</i>	Provided by Contractor
<i>BMP Description: Mulching (See Appendix E For Details)</i>	
<i>Installation Schedule:</i>	Provided by Contractor
<i>Maintenance and Inspection:</i>	See BMP ML in Appendix E
<i>Responsible Staff:</i>	Provided by Contractor
<i>BMP Description: Slope Drain (See Appendix E For Details)</i>	
<i>Installation Schedule:</i>	Provided by Contractor
<i>Maintenance and Inspection:</i>	See BMP SD in Appendix E
<i>Responsible Staff:</i>	Provided by Contractor
<i>BMP Description: Surface Roughening (See Appendix E For Details)</i>	
<i>Installation Schedule:</i>	Provided by Contractor
<i>Maintenance and Inspection:</i>	See BMP SR in Appendix E
<i>Responsible Staff:</i>	Provided by Contractor
<i>BMP Description: Temporary Drains and Swales (See Appendix E For Details)</i>	
<i>Installation Schedule:</i>	Provided by Contractor
<i>Maintenance and Inspection:</i>	See BMP TDS in Appendix E
<i>Responsible Staff:</i>	Provided by Contractor

SECTION 3: GOOD HOUSEKEEPING BMPS

3.1 Material Handling and Waste Management

BMP Description: Hazardous Waste Management (See Appendix B For Details)

<i>Installation Schedule:</i>	Utilize any time hazardous wastes are being brought to or used onsite.
<i>Maintenance and Inspection:</i>	Inspect areas regularly and arrange for regular collection.
<i>Responsible Staff:</i>	Provided by Contractor

BMP Description: Concrete Waste Management (See Appendix B For Details)

<i>Installation Schedule:</i>	Install before concrete is used onsite.
<i>Maintenance and Inspection:</i>	Inspect subcontractors to ensure concrete wastes are being properly managed. Dispose of hardened concrete on a regular basis.
<i>Responsible Staff:</i>	Provided by Contractor

3.2 Establish Proper Building Material Staging Areas

BMP Description: Materials Storage (See Appendix B For Details)

<i>Installation Schedule:</i>	Install before any construction materials are brought to the site
<i>Maintenance and Inspection:</i>	See BMP MS in Appendix B
<i>Responsible Staff:</i>	Provided by Contractor

3.3 Designate Washout Areas

BMP Description: Concrete Waste Management (See Appendix B For Details)

<i>Installation Schedule:</i>	Install before concrete is used onsite.
<i>Maintenance and Inspection:</i>	Inspect subcontractors to ensure concrete wastes are being properly managed. Dispose of hardened concrete on a regular basis.
<i>Responsible Staff:</i>	Provided by Contractor

3.4 Establish Proper Equipment/Vehicle Fueling and Maintenance Practices

BMP Description: Vehicle and Equipment Fueling (See Appendix B For Details)

<i>Installation Schedule:</i>	Install before fuel is brought to the site
<i>Maintenance and Inspection:</i>	Inspect tanks and fueling areas regularly and keep spill cleanup materials onsite.
<i>Responsible Staff:</i>	Provided by Contractor

3.5 Control Equipment/Vehicle Washing

BMP Description: Equipment and Vehicle Wash Down Area (See Appendix B For Details)

<i>Installation Schedule:</i>	Install before construction vehicles leave the site
<i>Maintenance and Inspection:</i>	Inspect daily for loss of gravel or sediment buildup. Repair as required.
<i>Responsible Staff:</i>	Provided by Contractor

BMP Description: Vehicle and Equipment Cleaning (See Appendix B For Details)

<i>Installation Schedule:</i>	Install Before any construction vehicles leave the site
<i>Maintenance and Inspection:</i>	Requirements for this BMP are minimal. Some repair may be necessary.
<i>Responsible Staff:</i>	Provided by Contractor

3.6 Spill Prevention and Control Plan

BMP Description: Spill Clean-Up (See Appendix B For Details)

<i>Installation Schedule:</i>	Immediately upon spills that may be harmful to receiving waters
<i>Maintenance and Inspection:</i>	Clean up spills immediately and remediate cause. Document all spills with required data. Contact required authorities for any spill of reportable quantity.
<i>Responsible Staff:</i>	Provided by Contractor

3.7 Any Additional BMPs

N/A

3.8 Allowable Non-Stormwater Discharge Management

BMP Description: Dust Controls (See Appendix B For Details)

<i>Installation Schedule:</i>	Use regularly as needed to prevent dust from leaving the site in the air.
<i>Maintenance and Inspection:</i>	Weekly and as needed, ensure equipment used for dust controls is functioning properly. Inspect site weekly for areas of dust concern, and promptly utilize BMP DC as needed.
<i>Responsible Staff:</i>	Provided by Contractor

BMP Description: Street Sweeping (See Appendix B For Details)

<i>Installation Schedule:</i>	Use throughout construction.
<i>Maintenance and Inspection:</i>	Check streets daily for sediment buildup from construction activity. Sweep when found.
<i>Responsible Staff:</i>	Provided by Contractor

BMP Description: Material Use (See Appendix B For Details)

<i>Installation Schedule:</i>	Use throughout duration of construction and train personnel before material is used on site
<i>Maintenance and Inspection:</i>	Use less hazardous materials when possible and follow manufacturer recommendations. Maintenance requirements are low.
<i>Responsible Staff:</i>	Provided by Contractor

BMP Description: Materials Storage (See Appendix B For Details)

<i>Installation Schedule:</i>	Designate secure area with limited access. Construct appropriate barrier and ensure personnel utilize storage area.
<i>Maintenance and Inspection:</i>	Inspect daily and repair any damage to perimeter controls. Ensure containers are upright and tightly closed when stored.
<i>Responsible Staff:</i>	Provided by Contractor

BMP Description: Building Repair, Remodeling, and Construction (See Appendix B For Details)

<i>Installation Schedule:</i>	Utilize during construction of medical office.
<i>Maintenance and Inspection:</i>	Maintenance is minimal for this BMP.
<i>Responsible Staff:</i>	Provided by Contractor

BMP Description: Portable Toilets (See Appendix B For Details)

<i>Installation Schedule:</i>	Locate in convenient locations. Construct as required.
<i>Maintenance and Inspection:</i>	Utilize licensed service with daily observation for leak detection. Arrange for collection with licensed service.
<i>Responsible Staff:</i>	Provided by Contractor

SECTION 4: SELECTING POST-CONSTRUCTION BMPs

BMP Description: Dust Controls (See Appendix B For Details)

<i>Installation Schedule:</i>	Use regularly as needed to prevent dust from leaving the site in the air.
<i>Maintenance and Inspection:</i>	Weekly and as needed, ensure equipment used for dust controls is functioning properly. Inspect site weekly for areas of dust concern, and promptly utilize BMP DC as needed.
<i>Responsible Staff:</i>	Provided By Contractor.

BMP Description: Silt Fence (See Appendix B For Details)

<i>Installation Schedule:</i>	Install before any soil disturbance occurs.
<i>Maintenance and Inspection:</i>	Inspect immediately after any rainfall. Look for bypassing or undercutting and repair as required. Remove sediment that reaches one-half fence height.
<i>Responsible Staff:</i>	Provided By Contractor.

SECTION 5: INSPECTIONS

5.1 Inspections

1. Inspection Personnel: _____, _____

2. Inspection Schedule and Procedures:

See Appropriate BMP's listed in Sections 2, 3, 4, and 7 for Details
 See Appendix D for Inspection Form

5.2 Delegation of Authority

Duly Authorized Representative(s) or Position(s):

Company Name:

Name:

Position:

Address:

City, State, Zip:

Telephone Number:

Fax Number:

A copy of the delegation of authority form to be signed is found in Appendix D.

5.3 Corrective Action Log

Corrective Action Log:

A copy of the Corrective Action Log is located in Appenix D.

SECTION 6: RECORDKEEPING AND TRAINING

6.1 Recordkeeping

Records will be retained for a minimum period of at least 3 years after the permit is terminated.

Date(s) when major grading activities occur: _____

Date(s) when construction activities temporarily or permanently cease on a portion of the site:

Permanently Cease on _____

Date(s) when an area is either temporarily or permanently stabilized:

Permanently Stabilized on _____

6.2 Log of Changes to the SWPPP

Changes and updates to the SWPPP will be logged as they occur.

6.3 Training

Individual(s) Responsible for Training:

Describe Training Conducted:

- General stormwater and BMP awareness training for staff and subcontractors
- Detailed training for staff and subcontractors with specific stormwater responsibilities

SECTION 7: FINAL STABILIZATION

BMP Description: Seeding and Planting (See Appendix B For Details)

<i>Installation Schedule:</i>	Provided by Landscaper
<i>Maintenance and Inspection:</i>	Adequate watering and fertilization shall be used. Grass shall be watered and mowed.
<i>Responsible Staff:</i>	Provided by Contractor

SECTION 8: CERTIFICATION AND NOTIFICATION

Owner Certification

I certify under penalty of law that this document and all attachments were prepared under my direction or supervision in accordance with a system designed to assure that qualified personnel properly gathered and evaluated the information submitted. Based on my inquiry of the person or persons who manage the system, or those persons directly responsible for gathering the information, the information submitted is, to the best of my knowledge and belief, true, accurate, and complete. I am aware that there are significant penalties for submitting false information, including the possibility of fine and imprisonment for knowing violations.

Name: _____ Title: _____

Signature: _____ Date: _____

Company: _____ Site: _____

[Repeat as needed for multiple construction operators at the site](#)

Operator/Contractor Certification

I certify under penalty of law that this document and all attachments were prepared under my direction or supervision in accordance with a system designed to assure that qualified personnel properly gathered and evaluated the information submitted. Based on my inquiry of the person or persons who manage the system, or those persons directly responsible for gathering the information, the information submitted is, to the best of my knowledge and belief, true, accurate, and complete. I am aware that there are significant penalties for submitting false information, including the possibility of fine and imprisonment for knowing violations.

Name: _____ Title: _____

Signature: _____ Date: _____

Company: _____ Site: _____

[Repeat as needed for multiple construction operators at the site](#)

Operator/Contractor Certification

I certify under penalty of law that this document and all attachments were prepared under my direction or supervision in accordance with a system designed to assure that qualified personnel properly gathered and evaluated the information submitted. Based on my inquiry of the person or persons who manage the system, or those persons directly responsible for gathering the information, the information submitted is, to the best of my knowledge and belief, true, accurate, and complete. I am aware that there are significant penalties for submitting false information, including the possibility of fine and imprisonment for knowing violations.

Name: _____ Title: _____

Signature: _____ Date: _____

Company: _____ Site: _____

[Repeat as needed for multiple construction operators at the site](#)

Professional Certification

I certify under penalty of law that this document and all attachments were prepared under my direction or supervision in accordance with a system designed to assure that qualified personnel properly gathered and evaluated the information submitted. Based on my inquiry of the person or persons who manage the system, or those persons directly responsible for gathering the information, the information submitted is, to the best of my knowledge and belief, true, accurate, and complete. I am aware that there are significant penalties for submitting false information, including the possibility of fine and imprisonment for knowing violations.

Name: Ryan Bingham

Title: P.E.

Signature: 

Date: 2.11.13

Company: **Great Basin Engineering**

This plan has been prepared according to the Clean Water Act and represents a planning tool to assist the contractor to comply with environmental regulations during the project construction. The decisions on how to operate the construction site rest solely with the contractor and not with **Great Basin Engineering**.

Unless otherwise noted, referenced standards and specifications for BMPs included in this document follow recommendations by the U.S. Environmental Protection Agency. If the BMP details are not sufficient, pose a threat to public health or property, or a threat to safety is perceived to exist by using the recommended BMPs, please contact **Great Basin Engineering**.

SWPPP DRAWINGS AND APPENDICES

Drawings – Site Maps and General Location Map

Appendix A – Construction General Permit

Appendix B – Standards and Specifications for Selected BMP's

Appendix C – Material Safety Data Sheets

Appendix D – Blank Forms

Appendix E – Additional Non-Selected BMP's

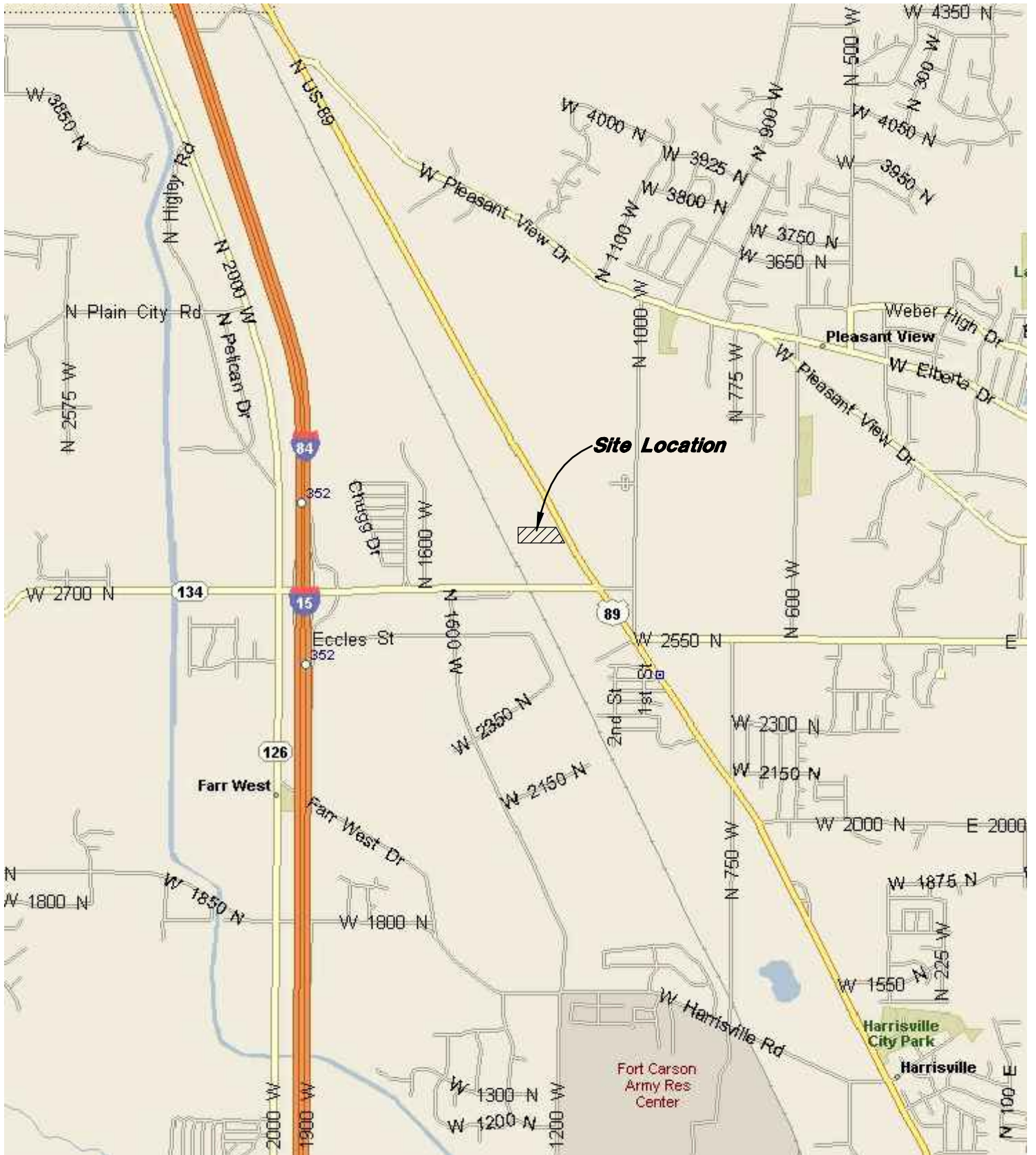

General Location Map



- SELECTED BMP'S**
1. Utilize BMP BRR Building Repair, Remodeling, and Construction
 2. Utilize BMP CWM Concrete Waste Management
 3. Utilize BMP DC Dust Controls
 4. Utilize BMP EWA Equipment and Vehicle Wash Down Area
 5. Utilize BMP HWM Hazardous Waste Management
 6. Const. BMP IP Inlet Protection (Concrete Block or Gravel)
 7. Utilize BMP MS Materials Storage
 8. Utilize BMP MU Material Use
 9. Utilize BMP PEV Preservation of Existing Vegetation
 10. Const. BMP PT Portable Toilets
 11. Const. BMP SCE Stabilized Construction Entrance
 12. Utilize BMP SCU Spill Clean-Up
 13. Const. BMP SF Silt Fence
 14. Const. BMP SP Seeding and Planting
 15. Utilize BMP VEG Vehicle and Equipment Cleaning
 16. Utilize BMP VEF Vehicle and Equipment Fueling
 17. Utilize BMP SS Street Sweeping

PRIVATE ENGINEER'S NOTICE TO CONTRACTORS

The Contractor agrees that he shall assume sole and complete responsibility for job site conditions during the course of construction of this project, including safety of all persons and property; that this requirement shall apply continuously and not be limited to normal working hours; and that the contractor shall defend, indemnify, and hold the owner and the engineer harmless from any and all liability, real or alleged, in connection with the performance of work on this project, excepting for liability arising from the sole negligence of the owner or the engineer.

ALL CONSTRUCTION TO CONFORM TO CITY STANDARDS AND SPECIFICATIONS IN RIGHT OF WAY

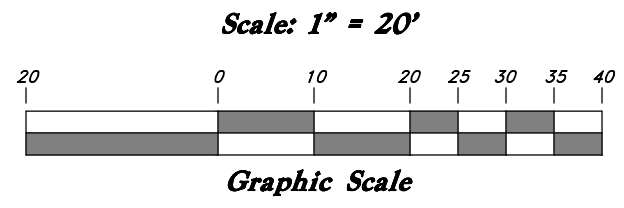
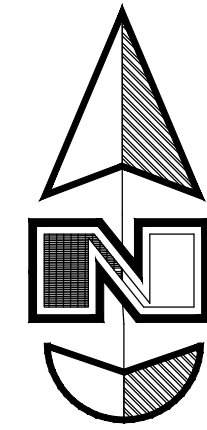

Legend

- (Note: All items may not appear on drawing)
- San. Sewer Manhole
 - Water Manhole
 - Storm Drain Manhole
 - Electrical Manhole
 - Catch Basins
 - Exist. Fire Hydrant
 - Fire Hydrant
 - Exist. Water Valve
 - Water Valve
 - Sanitary Sewer
 - Culinary Water
 - Gas Line
 - Irrigation Line
 - Storm Drain
 - Telephone Line
 - Secondary Waterline
 - Power Line
 - Fire Line
 - Land Drain
 - Power pole
 - Power pole w/guy
 - Light Pole
 - Fence
 - Flowline of ditch
 - Overhead Power line
 - Corrugated Metal Pipe
 - Concrete Pipe
 - Reinforced Concrete Pipe
 - Ductile Iron
 - Polyvinyl Chloride
 - Top of Asphalt
 - Centerline
 - Flowline
 - Finish Floor
 - Top of Curb
 - Top of Wall
 - Top of Concrete
 - Natural Ground
 - Finish Contour
 - Exist. Contour
 - Finish Grade
 - Exist. Grade
 - Ridge Line
 - Direction of Flow
 - Existing Asphalt
 - New Asphalt
 - Heavy Duty Asphalt
 - Concrete
 - Open Face
 - Curb & Gutter

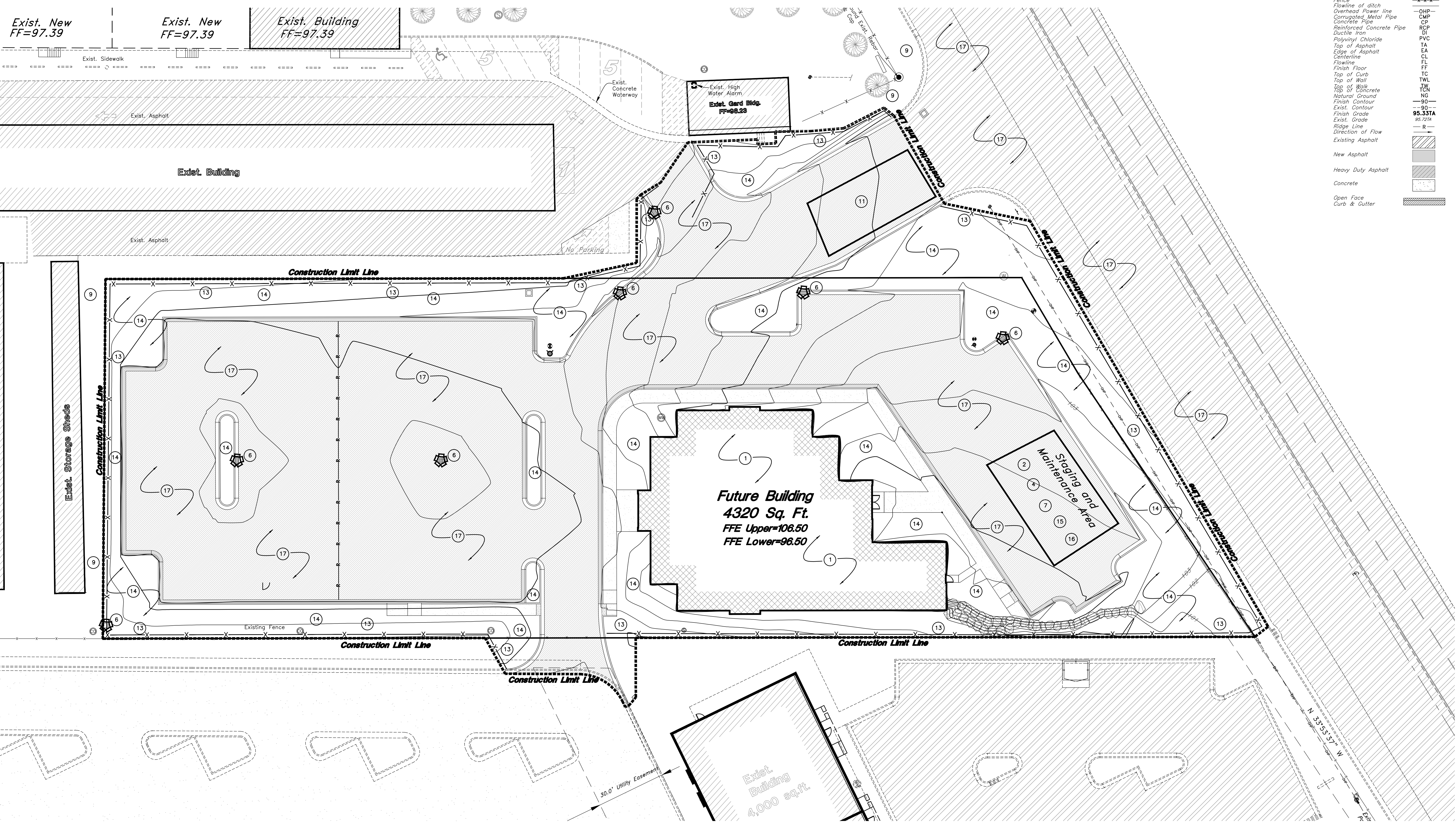

GREAT BASIN ENGINEERING NORTH
 CONSULTING ENGINEERS AND SURVEYORS
 5746 South 1475 East - Suite 200
 Ogden, Utah 84403
 P.O. Box 150048, Ogden, Utah 84415
 Open (801)394-4315 Salt Lake City (801)521-0222 Fax (801)392-2544

Storm Water Pollution Prevention Plan
North View Holdings LLC
 2700 North Highway 89
 Weber County, Utah

01 Feb, 2013
 SHEET NO.
CW1.01
 08N22254

APPENDIX A

**STATE OF UTAH DEPARTMENT OF ENVIRONMENTAL QUALITY
DIVISION OF WATER QUALITY**

**Authorization to Discharge Under the
Utah Pollutant Discharge Elimination System**

**Storm Water General Permit for
Construction Activities
Permit No. UTR300000**

This Permit is issued in compliance with the provisions of the Utah Water Quality Act, Title 19, Chapter 5, Utah Code Annotated 2004, as amended (the "Act") and the federal Water Pollution Control Act (33 U.S.C. §§ 1251 *et. seq.*, as amended to date), and the rules and Regulations made pursuant to those statutes.

This Permit authorizes storm water discharges to waters of the State of Utah resulting from construction activities, including construction support activities, anywhere within the State of Utah as provided in Parts 1.4 and 1.5 of this Permit. This authorization is conditioned upon a discharger meeting the eligibility requirements in Part 1.2.2 of this Permit, including preparation of a Storm Water Pollution Prevention Plan prior to filing a Notice of Intent ("NOI") to discharge under this General Permit. A discharger is not covered by this Permit if the discharger submits an NOI but has not met these conditions.

This authorization is subject to the authority of the Utah Water Quality Board or the Executive Secretary of the Utah Water Quality Board to reopen this Permit (*see* Part 5.15 of this Permit), or to require a discharger to obtain an individual permit or use an alternative general permit (*see* Part 2.3 of this Permit). The issuance of a discharge permit authorization under this general Permit does not relieve Permittees of other duties and responsibilities under the Act or rules made under that Act. Significant terms used in this Permit are defined in Part 6 of this Permit.

This Permit shall become effective on July 1, 2008.

This Permit and the authorization to discharge shall expire at midnight, June 30, 2013, except as described in Part 2.4 of this Permit.

Signed this 26th day of June, 2008.

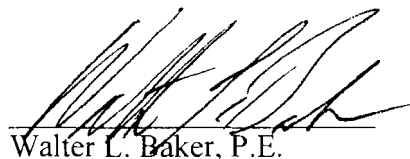

Walter L. Baker, P.E.
Executive Secretary,
Utah Water Quality Board

TABLE OF CONTENTS

PART 1: PERMIT SCOPE AND COVERAGE	3
1.1 Persons Required to Obtain Authorization for Discharge.	3
1.2 Permit Area and Eligibility.	3
1.3 Authorization to Discharge.	3
1.4 Allowable Storm Water Discharges.	3
1.5 Allowable Non-storm Water Discharges.	4
1.6 Discharges Not allowed Under This Permit.	4
1.7 Authorization to Discharge Date.	5
1.8 Notice of Intent	5
1.9 Coverage Before October 1, 2008.	5
1.10 Late Notifications.	6
PART 2. SPECIAL CONDITIONS, MANAGEMENT PRACTICES, RESPONSIBILITIES, AND OTHER NON-NUMERIC LIMITATIONS	7
2.1 Releases in Excess of Reportable Quantities.	7
2.2 Discharge Compliance with Water Quality Standards and TMDL Requirements.	7
2.3 Requiring an Individual Permit or an Alternative General Permit.	8
2.4 Continuation of the Expired General Permit.	9
PART 3. STORM WATER POLLUTION PREVENTION PLANS	10
3.1 SWPPP Required.	10
3.2 SWPPP Location, Availability, Revision, and Signature.	10
3.3 Keeping SWPPPs Current.	11
3.4 More Than One Permittee.	11
3.5 Contents of SWPPP.	12
PART 4. TERMINATION/CHANGES IN OWNER/OPERATOR FOR SITE	19
4.1 Termination of Coverage	19
4.2 Conditions for Submitting an NOT.	19
4.3 Updating the SWPPP	
PART 5. STANDARD PERMIT CONDITIONS	20
5.1 Duty to Comply.	20
5.2 Duty to Reapply.	20
5.3 Need to Halt or Reduce Activity Not a Defense.	20
5.4 Duty to Mitigate.	20
5.5 Duty to Provide Information.	20
5.6 Other Information.	20
5.7 Oil and Hazardous Substance Liability.	21
5.8 Property Rights.	21
5.9 Severability	21
5.10 Record Retention.	21
5.11 Addresses.	21
5.12 State Laws.	21
5.13 Proper Operation and Maintenance.	21
5.14 Inspection and Entry	22
5.15 Reopener Clause.	22
5.16 Signatory Requirements.	22
PART 6. DEFINITIONS	24

PART 1: PERMIT SCOPE AND COVERAGE

- 1.1 Persons required to obtain authorization for discharge. No person may conduct construction activities that disturb an area greater than or equal to one acre without authorization for storm water discharge from the Executive Secretary. (See Utah Admin. Code Sections R317-8-3.9(6)(d)(10) and R317-8-3.9(6)(e)(1).) In addition, no person may conduct construction activities that disturb an area smaller than one acre if the disturbance is part of a larger common plan of development or sale that will ultimately disturb an area greater than or equal to one acre. *Id.* See Part 6.5 of this Permit for a definition of “construction activities.”
- 1.2 Permit Area and Eligibility.
 - 1.2.1. Construction activities located within the State of Utah, except for Indian Country (see Part 6.16 of this Permit for a definition of “Indian Country”) may be eligible to be covered under this Permit.
 - 1.2.2. Eligibility for authorization to discharge under this Permit is conditioned upon:
 - a. Preparation of a Storm Water Pollution Prevention Plan (“SWPPP”) (see Part 3 of this permit) prior to submission of a Notice of Intent (“NOI”);
 - b. Submission of a complete and accurate Notice of Intent to be covered by this Permit (see Part 1.8 of this Permit); and
 - c. Payment of applicable fees.
- 1.3 Authorization to Discharge. This Permit authorizes discharges of storm water from construction activities that disturb an area greater than or equal to one acre, and from construction activities that disturb an area smaller than one acre if the disturbance is part of a larger common plan of development or sale that will ultimately disturb an area greater than or equal to one acre. This authorization is subject to all of the terms and conditions of this Permit, including the requirement that the discharger must submit a Notice of Intent (“NOI”), and the prohibitions on discharges specified in Part 1.6.
- 1.4 Allowable Storm Water Discharges. Subject to compliance with the terms and conditions of this Permit, a Permittee is authorized to discharge pollutants in:
 - 1.4.1. Storm water associated with construction activity as that term is defined in Part 6.5 of this Permit (but see Part 1.4.3 of this Permit for limitations on discharges from construction support activities);
 - 1.4.2. Storm water discharges designated by the Executive Secretary as needing a storm water permit under R317-8-3.9(6)(e)(2);
 - 1.4.3. Discharges from construction support activities as that term is defined in Part 6.6 of this Permit, provided:
 - a. The support activity is directly related to the construction site required to have UPDES permit coverage for discharges of storm water associated with construction activity;
 - b. The support activity is not a commercial operation serving multiple unrelated construction projects by different owners/operators, and does not operate beyond the completion of the construction activity at the last construction project it supports; and
 - c. Appropriate controls and measures are identified in a Storm Water Pollution

Prevention Plan (SWPPP) covering the discharges from the support activity areas; and

- 1.4.4. Discharges composed of allowable discharges listed in Part 1.4 and 1.5 of this Permit commingled with a discharge authorized by a different UPDES permit and/or a discharge that does not require UPDES permit authorization.
- 1.5. Allowable Non-storm Water Discharges. A Permittee is authorized to make the following non-storm water discharges, provided the non-storm water component of the discharge is in compliance with Part 3.5.5 of this Permit:
 - 1.5.1. Discharges from fire-fighting activities;
 - 1.5.2. Fire hydrant flushings;
 - 1.5.3. Waters used to wash vehicles where detergents are not used;
 - 1.5.4. Water used to control dust in accordance with Part 3.5.2(c)(2);
 - 1.5.5. Potable water including uncontaminated water line flushings;
 - 1.5.6. Routine external building wash down that does not use detergents;
 - 1.5.7. Pavement wash waters where spills or leaks of toxic or hazardous materials have not occurred (unless all spilled material has been removed) and where detergents are not used;
 - 1.5.8. Uncontaminated air conditioning or compressor condensate;
 - 1.5.9. Uncontaminated ground water or spring water;
 - 1.5.10. Foundation or footing drains where flows are not contaminated with process materials such as solvents;
 - 1.5.11. Landscape and other irrigation drainage.
- 1.6. Discharges not allowed under this Permit. Notwithstanding any other language in this Permit, the following storm water discharges are not authorized by this Permit:
 - 1.6.1. Discharges from Construction Activities within Indian Country. This Permit does not cover discharges within Indian Country as that term is defined in Part 6.16 of this Permit;¹
 - 1.6.2. Post Construction Discharges. Storm water discharges that originate from the site after construction activities have been completed and the site has undergone final stabilization;
 - 1.6.3. Discharges Mixed with Non-storm Water. Discharges that are mixed with sources of non-storm water other than discharges which are identified in Part 1.5 of this Permit and in compliance with Part 3.5.5 (non-storm water discharges) of this Permit;
 - 1.6.4. Discharges Covered by Another Permit. Storm water discharges associated with construction activity for which an individual permit has been issued, or for which the owner/operator is required to or may obtain coverage under an individual permit or an alternative general permit (*see* Part 2.3 of this Permit), including a general

¹ The State of Utah, *Division of Water Quality*, does not have permit authority for Indian Country. Storm water permits for Indian Country within the State must be acquired through EPA Region VIII, except for facilities on the Navajo Reservation or on the Goshute Reservation which must acquire storm water permits through EPA Region IX.

permit issued for areas regulated by a qualified municipal Separate Storm Sewer System Program;

- 1.6.5. Discharges Threatening Water Quality. Storm water discharges from construction activities that cause or have the reasonable potential to cause a violation of a water quality standard. *See* Part 2.2 of this Permit;
 - 1.6.6. Discharges from commercial construction support and related activities. Storm water discharges from construction support activities unless they are included within the definition in Part 6.6 of this permit;
 - 1.6.7. Spills. This Permit does not authorize the discharge of hazardous substances or oil resulting from an on-site spill; and
 - 1.6.8. Discharges that result from violations of this Permit.
- 1.7 Authorization to Discharge Date.
- 1.7.1. This permit is effective as of July 1, 2008 and is effective for five years, expiring at 11:59 p.m. on June 30, 2013.
 - 1.7.2. Unless notified by the Executive Secretary to the contrary, a discharger is authorized for coverage under this Permit and may begin construction activities immediately after preparing a SWPPP for the construction activities (*see* Part 1.2.2(a) of this Permit), and after submitting an NOI and permit fee (*see* Part 1.2.2(b) and (c) of this Permit). The date of submission of the NOI or a permit fee shall be the date of its receipt by the Executive Secretary, or the date the NOI or permit fee are submitted electronically using the website for the Utah Division of Water Quality. Any NOIs mailed to the Executive Secretary shall be mailed to the address specified in Part 5.11 of this Permit.
 - 1.7.3. The Executive Secretary may, with written notice (including electronic notice) delay authorization to verify an applicant's eligibility or resolve other concerns. In these instances, a discharger is not authorized for coverage under this permit until it receives notice from the Executive Secretary.
- 1.8 Notice of Intent
- 1.8.1. A person who wishes to submit an NOI must use the NOI form provided by the Executive Secretary (or a copy thereof), or submit an NOI electronically (*see* (<https://secure.utah.gov/stormwater/>)).
 - 1.8.2. All questions in an NOI form provided by the Executive Secretary or answered in the course of submitting an NOI electronically must be answered completely and accurately.
 - 1.8.3. The NOI, whether on the form provided by the Executive Secretary or submitted electronically, must include a certification statement, and must be signed and dated by an authorized representative as specified in Part 5.16 of this Permit.
- 1.9 Coverage before June 30, 2010. Permittee's that previously received authorization to discharge under the October 1, 2002 General Permit (2002 General Permit) and still have active coverage shall without submission of an NOI continue coverage under UTR200000 until June 30, 2010 at which time, or before if desired, the Permittee shall, by submission of an NOI (either on-line www.waterquality.utah.gov/updes/stormwatercon.htm or by paper submission) obtain coverage under this Permit (UTR300000).

- 1.10 Late Notifications. Persons are not prohibited from submitting NOIs after initiating clearing, grading, excavation activities, or other construction activities. When a late NOI is submitted, authorization for discharges occurs consistent with Subpart 2.1. The Agency reserves the right to take enforcement action for any un-permitted discharges that occur between the commencement of construction and discharge authorization.

**PART 2. SPECIAL CONDITIONS, MANAGEMENT PRACTICES,
RESPONSIBILITIES, AND OTHER NON-NUMERIC LIMITATIONS**

- 2.1 Releases in excess of Reportable Quantities. The discharge of hazardous substances or oil in the storm water discharge(s) from a site shall be prevented or minimized in accordance with the applicable SWPPP for the site. This Permit does not relieve the Permittee of the reporting requirements of 40 CFR part 117, 40 CFR 110, and 40 CFR part 302. Where a release containing a hazardous substance in an amount equal to or in excess of a reportable quantity established under either 40 CFR 117, 40 CFR 110, or 40 CFR 302, occurs during a 24 hour period:
- 2.1.1. The Permittee is required to notify the National Response Center (NRC) (800-424-8802) in accordance with the requirements of 40 CFR 117, 40 CFR 110, and 40 CFR 302 and the Division of Water Quality (DWQ) (801-538-6146) or the 24 hour DWQ answering service at 801-536-4123 as soon as he or she has knowledge of the discharge;
 - 2.1.2. The Permittee shall submit within 14 calendar days of knowledge of the release a written description of: the release (including the type and estimate of the amount of material released), the date that such release occurred, the circumstances leading to the release, the measures taken and/or planned to be taken to cleanup the release, and steps to be taken to minimize the chance of future occurrences to the Executive Secretary; and
 - 2.1.3. The SWPPP required under Part 3 of this Permit must be modified within 14 calendar days of knowledge of the release to provide a description of the release, the circumstances leading to the release, and the date of the release. In addition, the SWPPP must be reviewed to identify measures to prevent the reoccurrence of such releases and to respond to such releases, and the SWPPP must be modified where appropriate.
- 2.2 Discharge Compliance with Water Quality Standards and TMDL requirements. Storm water discharges from construction activities that cause or have the reasonable potential to cause a violation of a water quality standard or a violation of Total Maximum Daily Load (“TMDL”) requirements are not authorized by this Permit. If there is a TMDL requirement for the receiving water, that requirement, rather than a water quality standard, will govern. If a discharge that would otherwise be covered by this Permit causes a violation or if there is a reasonable potential a discharge will cause a violation, the Permittee will take all necessary actions to ensure future discharges do not cause or contribute to the violation of a water quality standard or a TMDL requirement, and shall document these actions in the SWPPP.

If the Executive Secretary determines that construction activities have caused or have the reasonable potential to cause a violation of a water quality standard or a TMDL requirement, the discharger will be notified by the Executive Secretary of additional requirements for treatment or handling of the discharge to ensure future discharges do not cause or contribute to the violation. The Permittee will document these requirements in the SWPPP. The Executive Secretary may authorize continued coverage under this Permit after appropriate controls and implementation procedures, designed to bring the discharges

into compliance with water quality standards or TMDL requirements, have been included in the SWPPP.

Alternatively, the Executive Secretary may notify the Permittee that an individual permit application is necessary (see Part 2.3 of this Permit).

If violations remain or re-occur, then coverage under this Permit may be terminated by the Executive Secretary and an alternative permit may be issued or denied. Compliance with this requirement does not preclude any enforcement activity as provided by the Water Quality Act for the underlying violation.

2.3 Requiring an Individual Permit or an Alternative General Permit.

- 2.3.1. The Executive Secretary may require any person authorized by this Permit to apply for and/or obtain either an individual UPDES permit or an alternative UPDES general permit. Any interested person may petition the Executive Secretary to take action under this paragraph. Where the Executive Secretary requires a discharger authorized to discharge under this Permit to apply for an individual UPDES permit, the Executive Secretary shall notify the discharger in writing that a permit application is required. This notification shall include a brief statement of the reasons for this decision, an application form or reference to the application requirements, a statement setting a deadline for the discharger to file the application, and a statement that on the effective date of issuance or denial of the individual UPDES permit or the alternative general permit as it applies to the individual Permittee, coverage under this general Permit shall automatically terminate. Applications shall be submitted to the address of the Division of Water Quality shown in Part 5.11 of this Permit. The Executive Secretary may grant additional time to submit the application upon request of the applicant. If a discharger fails to submit in a timely manner an individual UPDES permit application as required by the Executive Secretary under this paragraph, then the applicability of this Permit to the individual UPDES permittee is automatically terminated at the end of the day specified for application submittal.
- 2.3.2. Any discharger authorized by this Permit may request to be excluded from the coverage of this Permit by applying for an individual permit. In such cases, the discharger shall submit an individual application in accordance with the requirements of Utah Administrative Code ("UAC") R317-8-3.9(2)(b)2 with reasons supporting the request, to the Executive Secretary at the address for the Division of Water Quality in Part 5.11 of this Permit. The request may be granted by issuance of any individual permit or an alternative general permit if the reasons cited by the Permittee are adequate to support the request.
- 2.3.3. When an individual UPDES permit is issued to a discharger who would otherwise be subject to this Permit, or the discharger is authorized to discharge under an alternative UPDES general permit, the applicability of this Permit to the individual UPDES permittee is automatically terminated on the effective date of the individual permit or the date of authorization for coverage under the alternative general permit, whichever the case may be. When an individual UPDES permit is denied to a discharger otherwise subject to this Permit or the discharger is denied for coverage under an alternative UPDES general permit, the applicability of this Permit to the

individual UPDES permittee is automatically terminated on the date of such denial, unless otherwise specified by the Executive Secretary.

- 2.4 Continuation of the Expired General Permit. This Permit expires on June 30, 2013. However, an expired general permit shall continue in force and effect after the expiration date until a new general permit is issued. If a discharger was eligible for and permitted under this Permit, and this Permit expires, the discharger will remain covered by this Permit until the earliest of:
- 2.4.1. One hundred twenty days after re-issuance or replacement of this Permit;
 - 2.4.2. The discharger submits a Notice of Termination in compliance with this Permit;
 - 2.4.3. The discharger is issued an individual permit for the project's discharges; or
 - 2.4.4. 180 days after the Executive Secretary makes a formal decision not to reissue or replace this Permit, at which time the discharger must seek coverage under an alternative general permit or an individual permit.

PART 3. STORM WATER POLLUTION PREVENTION PLANS

- 3.1. SWPPP required. A Storm Water Pollution Prevention Plan (“SWPPP”) shall be developed for each construction project covered by this Permit prior to submission of an NOI. A SWPPP shall be prepared in accordance with good engineering practices. It is recommended that the plan be signed by a Professional Engineer (P.E.) registered in the State. The SWPPP shall identify potential sources of pollution which may reasonably be expected to affect the quality of storm water discharges from the construction site, shall describe and ensure the implementation of practices which will be used to reduce the pollutants in storm water discharges associated with construction activity at the construction site and to assure compliance with the terms and conditions of this Permit, and shall otherwise meet the requirements of this Permit. As a condition of this Permit, Permittees must implement the SWPPP as written or modified from commencement of construction until final stabilization is complete and an NOT has been submitted. (This provision is not intended to address the potential liability of a Permittee or other current or former operator or owner in the event of a discharge of pollution from the property of an individual homeowner.)
- 3.2. SWPPP Location, Availability, Revision, and Signature.
- 3.2.1. SWPPP Location. A copy of the SWPPP, including a copy of the Permit, the NOI, and any amendments to the SWPPP, shall be retained on-site at the site which generates the storm water discharge in accordance with this Part 3.2 and with Part 5.10 of this Permit. If the site is inactive or does not have an onsite location adequate to store the copy of the SWPPP, reasonable local access to a copy of the SWPPP during normal working hours (e.g., at a local library or government building), must be provided and the location of the SWPPP, along with a contact phone number, shall be posted on site at a publicly-accessible location. For linear construction projects, such as pipelines, the posted notice shall be located at a publicly accessible location near the active part of the construction project.
- 3.2.2. SWPPP Availability. The Permittee shall make the copy of the SWPPP that is kept on-site or kept locally available for review upon request to the Executive Secretary; EPA; other local agencies approving sediment and erosion plans, grading plans, or storm water management plans; local government officials; or to the operators of a municipal separate storm sewer receiving discharges from the site. The Permittee need not provide a free copy of the SWPPP to these entities upon request, but if it chooses not to do so, it shall keep two copies of the SWPPP, in its entirety, and shall allow these entities to borrow one to make a copy at their own expense.
- 3.2.3. Original SWPPP. If requested by the Executive Secretary, the original SWPPP, including any previous versions requested, shall be provided to the Executive Secretary within five working days of the request. The original provided shall be signed in accordance with Part 5.16 of this Permit.
- 3.2.4. SWPPP Availability to the Public. The Permittee shall also make a copy of the SWPPP available to the public to review at reasonable times during regular business hours. Advance notice by the public of the desire to view the SWPPP may be required, not to exceed two working days. The Permittee need not provide a free copy of the SWPPP to members of the public, but if it chooses not to do so, it shall

- keep two copies of the SWPPP, in its entirety, and shall allow members of the public to borrow one to make a copy at their own expense.
- 3.2.5. Compelled Revisions. The Executive Secretary, or an authorized representative of the Executive Secretary, may notify the Permittee (co-Permittees) at any time that the SWPPP does not meet one or more of the minimum requirements of this Part 3. Such notification shall identify those provisions of the Permit which are not being met by the SWPPP, and identify which provisions of the SWPPP require modifications in order to meet the minimum requirements of this Part 3. Within 7 days of such notification from the Executive Secretary, (or as otherwise provided by the Executive Secretary), or authorized representative, the Permittee shall make the required changes to the SWPPP and shall submit to the Executive Secretary a written certification that the changes have been made. The Executive Secretary may take appropriate enforcement action for the period of time the Permittee was operating under a SWPPP that did not meet the minimum requirements of the Permit.
- 3.2.6. All SWPPPs must be signed and certified in accordance with Part 5.16 of this Permit.
- 3.3. Keeping SWPPPs Current.
- 3.3.1. The Permittee shall amend the SWPPP whenever there is a change in design, construction, operation, or maintenance, which has a significant effect on the discharge of pollutants to the waters of the State and which has not otherwise been addressed in the SWPPP.
- 3.3.2. The Permittee shall amend the SWPPP whenever inspections or investigations by site operators, local, state, or federal officials indicate the SWPPP is proving ineffective in eliminating or significantly minimizing pollutants from sources identified under Part 3.5.1 of this Permit, or is otherwise not achieving the general objectives of controlling pollutants in storm water discharges associated with construction activity.
- 3.3.3. The Permittee shall amend the SWPPP whenever a new owner/operator becomes responsible for implementing all or part of the SWPPP, as further described in Part 3.4 and Part 4.3 of this Permit.
- 3.3.4. The following records of activities shall be maintained as part of the SWPPP:
- Dates when major grading activities occur;
 - Dates when construction activities temporarily or permanently cease on a portion of or all of the site; and
 - Dates when stabilization measures are initiated.
- 3.3.5. Once an area has been finally stabilized, the Permittee may identify this area in the SWPPP and no further SWPPP or inspection requirements shall apply to that area.
- 3.4. More than one Permittee. A SWPPP may identify more than one Permittee and may specify the responsibilities of each Permittee by task, area, and/or timing. Permittees may coordinate and prepare more than one SWPPP to accomplish this. However, in the event there is a requirement under the SWPPP for which responsibility is ambiguous or is not included in the SWPPP(s), each Permittee shall be responsible for implementation of that requirement. Each Permittee is also responsible for assuring that its activities do not render another Permittee's controls ineffective.

3.5. Contents of SWPPP. The SWPPP shall include the following items:

3.5.1. Site Description. Each SWPPP shall provide a description of pollutant sources and other information as indicated:

- a. A description of the nature of the construction activity;
- b. A description of the intended sequence of major activities which disturb soils for major portions of the site (e.g. grubbing, excavation, grading, utilities, and infrastructure installation);
- c. Estimates of the total area of the site and the total area of the site that is expected to be disturbed by excavation, grading, or other activities, including areas for construction support;
- d. An estimate of the runoff coefficient of the site after construction activities are completed and existing data describing the soil or the quality of any discharge from the site;
- e. A general location map (e.g. portion of a city or county map or similar scale) and a site map indicating:
 - 1) drainage patterns and approximate slopes anticipated after major grading activities;
 - 2) construction boundaries and a description of existing vegetation prior to grading activities;
 - 3) areas of soil disturbance, and areas of no disturbance;
 - 4) the location of major structures and nonstructural controls identified in the SWPPP;
 - 5) Locations of areas used for construction support;
 - 6) the location of areas where stabilization practices are expected to occur;
 - 7) the location of surface waters (including wetlands); and
 - 8) locations where storm water is discharged or will discharge to a surface water;
- f. A description of any discharge associated with industrial activity other than construction at the site (including storm water discharges from dedicated portable asphalt plants and dedicated portable concrete plants), whether or not those discharges are covered by the Permit; and the location of that activity;
- g. The name of the receiving water(s), and aerial extent of wetland acreage at the site; and
- h. A copy of this Permit.

3.5.2. Controls. The SWPPP shall employ best management practices to control pollutants in storm water discharges. Each plan shall include a description of appropriate controls and measures that will be implemented during construction activity and while the site is unstabilized. The plan must clearly describe for each major activity identified in Part 3.5.1(b) appropriate control measures and the timing during the construction process that the measures will be implemented. The description and implementation of controls shall address the following minimum components:

- a. Erosion and Sediment Controls.
 - 1) Short and Long Term Goals and Criteria:
 - A) The construction-phase erosion and sediment controls should be designed to retain sediment on site to the maximum extent

- practicable.
- B) All control measures must be properly selected, installed, and maintained in accordance with the manufacturer's specifications and good engineering practices. If periodic inspections or other information indicates a control has been used inappropriately, incorrectly, or is ineffective the Permittee must replace or modify the control for site situations.
 - C) If sediments escape the construction site, off-site accumulations of sediment must be removed at a frequency sufficient to minimize the possibility of offsite impacts such as fugitive sediments washing into storm sewers by the next rain or posing a safety hazard to users of public streets.
 - D) Sediment must be removed from sediment traps or sedimentation ponds when design capacity has been reduced by 50%.
 - E) Litter, construction debris, and construction chemicals exposed to storm water shall be picked up prior to anticipated storm events (e.g. forecasted by local weather reports), or otherwise prevented from becoming a pollutant source for storm water discharges (e.g. screening outfalls, picked up daily, etc.).
 - F) Offsite material storage areas (also including overburden and stockpiles of dirt, etc.) used solely by the Permitted project are considered a part of the project and, unless a Permittee submits a separate NOI for such areas or they are subject to a separate UPDES permit, they shall be addressed in the SWPPP.
- 2) Stabilization Practices. A description of existing interim and permanent stabilization practices, including site-specific scheduling of the implementation of the practices. SWPPPs should ensure that existing vegetation is preserved where attainable and that disturbed portions of the site are stabilized. Stabilization practices may include: temporary seeding, permanent seeding, mulching, geo-textiles, sod stabilization, vegetative buffer strips, protection of trees, preservation of mature vegetation, and other appropriate measures. Use of impervious surfaces for stabilization should be avoided. Except as provided in paragraphs (A) and (B) below (Parts 3.5.2(a)(2)(A) and (B)), stabilization measures shall be initiated as soon as practicable in portions of the site where construction activities have temporarily or permanently ceased, but in no case more than 14 days after the construction activity in that portion of the site has temporarily or permanently ceased.
- A) Where the initiation of stabilization measures by the 14th day after construction activity temporarily or permanently ceases is precluded by snow cover or frozen ground conditions, stabilization measures shall be initiated as soon as practicable.
 - B) Where construction activity on a portion of the site is temporarily ceased, and earth disturbing activities will be resumed within 21 days, temporary stabilization measures do not have to be initiated on that portion of the site.
- 3) Structural Practices. The permittee shall provide a description of

structural practices that divert flows from exposed soils, store flows or otherwise limit runoff and the discharge of pollutants from exposed areas of the site to the degree attainable. Such practices may include silt fences, earth dikes, drainage swales, sediment traps, check dams, subsurface drains, pipe slope drains, level spreaders, storm drain inlet protection, rock outlet protection, reinforced soil retaining systems, gabions, and temporary or permanent sediment basins. Placement of structural practices in floodplains should be avoided to the degree attainable. The installation of these devices may be subject to Section 404 of the federal Clean Water Act (“CWA”).

- A) 10 Acre Sediment Basin Requirement. Where attainable, for common drainage locations that serve areas with 10 or more acres disturbed at one time, the Permittee shall provide a temporary (or permanent) sediment basin that provides storage for a 10 year, 24 hour storm event, a calculated volume of runoff for disturbed acres drained, or equivalent control measures, until final stabilization of the site. Where calculations are not performed, a sediment basin providing 3,600 cubic feet of storage per acre drained (a 1 inch storm event), or equivalent control measures, shall be provided where attainable until final stabilization of the site. The required sizing of the sediment basin does not include flows from offsite areas and flows from onsite areas that are either undisturbed or have undergone final stabilization where such flows are diverted around both the disturbed area and the sediment basin. In determining whether installing a sediment basin is attainable, factors such as site soils, slope, and available area on site shall be considered. For drainage locations which serve 10 or more disturbed acres at one time and where a temporary sediment basin or equivalent controls is not attainable, smaller sediment basins and/or sediment traps (with comparable storage) must be used; or
- (i) at a minimum, equivalent controls in silt fences, vegetative buffer strips, sod, mulch, geo-textiles, stepped check dams, pipe slope drains or other sediment or erosion controls are required for all erodible areas, down slope boundaries of the construction area and side slope boundaries deemed appropriate as dictated by individual site conditions; or
 - (ii) it can be shown that site meteorological conditions do not warrant equivalent storage during the time period the 10-acres are destabilized (little or no chance of precipitation for the period of surface destabilization).
- B) Less Than 10 Acre BMP Requirement. For drainage locations serving less than 10 acres, sediment basins and/or sediment traps should be used. At a minimum, silt fences, vegetative buffer strips, or equivalent sediment controls are required for all down slope boundaries (and those side slope boundaries deemed appropriate as dictated by individual site conditions) of the construction area unless a sediment basin providing storage for

3,600 cubic feet of storage per acre drained is provided.

- b. Storm Water Management. Description of measures that will be installed during the construction process to control pollutants in storm water discharges that will occur after construction operations have been completed. Structural measures should be placed on upland soils to the degree attainable. The installation of these devices may be subject to Section 404 of the CWA. This Permit only addresses the installation of storm water management measures, and not the ultimate operation and maintenance of such structures after the construction activities have been completed and the site has undergone final stabilization. Permittees are only responsible for the installation and maintenance of storm water management measures prior to final stabilization of the site, and are not responsible for maintenance after storm water discharges associated with construction activity have been eliminated from the site. However, post-construction storm water BMPs that discharge pollutants from point sources once construction is completed, may in themselves, need authorization under a separate UPDES permit and are likely regulated under local municipal requirements.
- 1) Such measures may include:
 - A) storm water detention structures (including wet ponds);
 - B) storm water retention structures;
 - C) flow-attenuation by use of open vegetated swales and natural depressions;
 - D) infiltration of runoff onsite; and
 - E) sequential systems (which combine several practices).
 - 2) The SWPPP shall include an explanation of the technical basis used to select the practices to control pollution where flows exceed predevelopment levels.
 - 3) Storm water velocity dissipation devices shall be placed at discharge locations and along the length of any outfall channel for the purpose of providing a non-erosive flow velocity from the structure to a water course so that the natural physical and biological characteristics and functions are maintained and protected. The objective is to minimize significant changes in the hydrological regime of the receiving water.
- c. Other Controls.
- 1) Waste Disposal. No solid materials, including building materials, shall be discharged to waters of the State, except as authorized by a federal CWA Section 404 permits.
 - 2) Off-site Tracking. Off-site vehicle tracking of sediments and the generation of dust shall be minimized.
 - 3) Septic, Waste, and Sanitary Sewer Disposal. The SWPPP shall ensure and demonstrate compliance with applicable State and/or local waste disposal, sanitary sewer or septic system regulations.
 - 4) Exposure to Construction Materials. The SWPPP shall include a narrative description of practices to reduce pollutants from construction related materials which are stored onsite including an inventory of construction materials (including waste materials), storage practices to minimize exposure of the materials to storm water, and spill prevention and

response.

- 5) Support Areas. A description of pollutant sources from areas other than construction (including storm water discharges from dedicated portable asphalt plants and dedicated portable concrete plants), and a description of controls and measures that will be implemented at those sites.

d. Other Laws and Requirements.

- 1) Local Storm Water Control Requirements. This Permit does not relieve the Permittee from compliance with other laws effecting erosion and sediment control or requirements for the permanent storm water system. Where applicable, compliance efforts to these requirements should be reflected in the SWPPP.
- 2) Threatened or Endangered Species & Historic Properties. This Permit does not relieve the Permittee from compliance with Federal or State laws pertaining to threatened or endangered species or historic properties. Where applicable compliance efforts to these laws should be reflected in the SWPPP.
- 3) Variance of Permit Requirements. Dischargers seeking alternative permit requirements shall submit an individual UPDES permit application in accordance with applicable law to the address indicated in Part 5.11 of this Permit, along with a description of why requirements in this Permit should not be applicable as a condition of a UPDES permit.

3.5.3. Maintenance. All vegetation, erosion and sediment control measures and other protective measures identified in the SWPPP shall be maintained in effective operating condition. A description of procedures to ensure the timely maintenance of these measures shall be identified in the SWPPP. Maintenance needs identified in inspections or by other means shall be accomplished before the next anticipated storm event, or as necessary to maintain the continued effectiveness of storm water controls. If maintenance prior to the next anticipated storm event is impracticable, maintenance must be scheduled and accomplished as soon as practicable.

3.5.4. Inspections.

- a. Inspections must be conducted in accordance with one of the two schedules listed below. The Permittee shall specify in its SWPPP which schedule it will be following.
 - 1) At least once every 7 calendar days; or
 - 2) At least once every 14 calendar days and within 24 hours of the end of a storm event of 0.5 inches or greater.
- b. Inspection frequency may be reduced to at least once every month if:
 - 1) The entire site is temporarily stabilized; or
 - 2) Runoff is unlikely due to winter conditions (e.g., site is covered with snow, ice, or the ground is frozen).
- c. The inspection requirement is waived until one month before thawing conditions are expected to result in a discharge if all of the following requirements are met:
 - 1) The project is located in an area where frozen conditions are anticipated to continue for extended periods of time (i.e., more than one month);

- 2) Land disturbance activities have been suspended; and
 - 3) The beginning and ending dates of the waiver period are documented in the SWPPP.
- d. Inspections must be conducted by qualified personnel (provided by the operator or cooperatively by multiple operators). "Qualified personnel" means a person knowledgeable in the principles and practice of erosion and sediment controls who possesses the skills to assess conditions at the construction site that could impact storm water quality and to assess the effectiveness of any sediment and erosion control measures selected to control the quality of storm water discharges from the construction activity.
- e. Inspections must include all areas of the site disturbed by construction activity and areas used for storage of materials that are exposed to precipitation. Inspectors must look for evidence of, or the potential for, pollutants entering the storm water conveyance system. Sedimentation and erosion control measures identified in the SWPPP must be observed to ensure proper operation. Discharge locations must be inspected to ascertain whether erosion control measures are effective in preventing significant impacts to waters of the United States, where accessible. Where discharge locations are inaccessible, nearby downstream locations must be inspected to the extent that such inspections are practicable. Locations where vehicles enter or exit the site must be inspected for evidence of off-site sediment tracking.
- f. Inspections at construction sites involving utility line installation, pipeline construction, and other long, narrow, linear construction may be more limited if the areas described in Part 3.5.4(e) of this Permit are not reasonably accessible or could cause additional disturbance of soils and increase the potential for erosion. In these circumstances, controls must be inspected at the same frequency as other construction projects, but personnel may instead inspect controls along the construction site for 0.25 mile above and below each access point where a roadway, undisturbed right-of-way, or other similar feature intersects the construction site and allows access to the areas described above. In the absence of evidence to the contrary, the conditions of the controls along each inspected 0.25 mile segment may be considered as representative of the condition of controls along that reach extending from the end of the 0.25 mile segment to either the end of the next 0.25 mile inspected segment, or to the end of the project, whichever occurs first.
- g. For each inspection required above, the inspector must complete an inspection report. At a minimum, the inspection report must include:
- 1) The inspection date;
 - 2) Names, titles, and qualifications of personnel making the inspection;
 - 3) Weather information for the period since the last inspection (or since commencement of construction activity if the first inspection) including a best estimate of the beginning of each storm event, duration of each storm event, approximate amount of rainfall for each storm event (in inches), and whether any discharges occurred;
 - 4) Weather information and a description of any discharges occurring at the time of the inspection;
 - 5) Location(s) of discharges of sediment or other pollutants from the site;

- 6) Location(s) of BMPs that need to be maintained;
 - 7) Location(s) of BMPs that failed to operate as designed or proved inadequate for a particular location;
 - 8) Location(s) where additional BMPs are needed that did not exist at the time of inspection; and
 - 9) Corrective action required including any changes to the SWPPP necessary and implementation dates.
- h. A record of each inspection and of any actions taken in accordance with this Part 3 must be retained as part of the SWPPP for at least three years from the date that permit coverage expires or is terminated. The inspection reports must identify any incidents of non-compliance with the permit conditions. Where a report does not identify any incidents of non-compliance, the report must contain a certification that the construction project or site is in compliance with the SWPPP and this permit. The report must be signed in accordance with Part 5.16 of this Permit.

3.5.5. Non-Storm Water Discharges. Except for flows from fire fighting activities, sources of non-storm water listed in Part 1.5 of this Permit that are combined with storm water discharges associated with industrial activity must be identified in the SWPPP. The SWPPP shall identify and ensure the implementation of appropriate pollution prevention measures for the non-storm water component(s) of the discharge.

PART 4 . TERMINATION/CHANGES IN OWNER/OPERATOR FOR SITE

- 4.1. Termination of Coverage: Permittees may or shall (as specified) terminate coverage under this Permit under the following conditions:
 - 4.1.1. Completion of construction activities and site stabilization: Permittees shall terminate coverage under this Permit by submitting a Notice of Termination (“NOT”) within thirty days after completion of all construction activities, completion of final stabilization of all areas of the site as defined in Part 6.15. The NOT shall be submitted on the form specified by the Executive Secretary.
 - 4.1.2. Partial completion of construction activities and site stabilization: A Permittee who, as specified in Part 3.4 of this Permit, is identified in the SWPPP as responsible for a specific area may terminate coverage under this Permit by submitting an NOT within thirty days after completion, for that area, of all construction activities, completion of final stabilization of all areas for which the Permittee was responsible and that were disturbed. The NOT shall be submitted on the form specified by the Executive Secretary, and the Permittee shall indicate on the form that it is a partial NOT.
 - 4.1.3. New responsible owner/operator: A Permittee may terminate its coverage under this Permit by submitting an NOT if another party (or parties) assumes responsibility for all remaining SWPPP requirements. Termination of the Permittee’s responsibilities under the SWPPP will not be final until the other party (or parties) submits an NOI. If the new responsible owner/operator fails to submit an NOI, the Permittee may complete termination by demonstrating to the Executive Secretary that it has entered into contracts that obligate the new owner/operator to undertake all remaining responsibilities under the SWPPP.
- 4.2. Conditions for Submitting an NOT: A Permittee may not submit an NOT unless it meets the requirements specified in Part 4.1. Appropriate enforcement actions may be taken if an NOT is submitted without these requirements having been met, and the Permittee may also continue to be responsible for any Permit violations.
- 4.3. Updating the SWPPP: If an NOT is submitted under Part 4.1.2 or 4.1.3, the SWPPP shall be updated by the remaining Permittee(s) to meet the requirements of Part 3.4 of the Permit.

PART 5. STANDARD PERMIT CONDITIONS

5.1. Duty to Comply.

5.1.1. The Permittee must comply with all conditions of this Permit. Any Permit noncompliance constitutes a violation of the Act and is grounds for enforcement action; for Permit termination, revocation and reissuance, or modification; or for denial of a permit renewal application.

5.1.2. Penalties for Violations of Permit Conditions.

a. Violations. The Act provides that any person who violates the Act, Utah wastewater rules, or conditions of a permit issued under the Act is subject to a fine of \$10,000 per day.

b. Willful or Gross Negligence. The Act provides that any person who discharges a pollutant to waters of the State as a result of criminal negligence or who intentionally discharges is criminally liable and is subject to imprisonment and a fine of up to \$50,000 per day. Utah Code Ann. § 19-5-115.

c. False Statements. The Act provides that any person who knowingly makes any false material statement, representation, or certification in any application, record, report, plan, or other document filed or required to be maintained under the Act, the rules, or this Permit, or who knowingly falsifies, tampers with, or renders inaccurate, any monitoring device or method required to be maintained under the Act shall upon conviction, be punished by a fine of not more than \$10,000 or by imprisonment for 6 months, or by both. Utah Code Ann. § 19-5-115(4).

5.2. Duty to Reapply. If a Permittee wishes to continue an activity regulated by this permit after the expiration date of this permit, it must apply for and obtain a new permit except as provided in Part 2.4 of this Permit.

5.3. Need to halt or reduce activity not a defense. It shall not be a defense for a Permittee in an enforcement action that it would have been necessary to halt or reduce the permitted activity in order to maintain compliance with the conditions of this Permit.

5.4. Duty to Mitigate. The Permittee shall take all reasonable steps to minimize or prevent any discharge in violation of this Permit which has a reasonable likelihood of adversely affecting human health or the environment.

5.5. Duty to Provide Information. The Permittee shall furnish to the Executive Secretary or an authorized representative, within a reasonable time, any information which is requested to determine compliance with this Permit. The Permittee must also furnish to the Executive Secretary or an authorized representative copies of records to be kept by this Permit.

5.6. Other Information. When the Permittee becomes aware that he or she failed to submit any relevant facts or submitted incorrect information in the Notice of Intent or in any other report to the Executive Secretary, he or she shall promptly submit such facts or information.

- 5.7. Oil and Hazardous Substance Liability. Nothing in this Permit shall be construed to preclude the institution of any legal action or relieve the Permittee from any responsibilities, liabilities, or penalties to which the Permittee is or may be subject under the "Act".
- 5.8. Property Rights. The issuance of this Permit does not convey any property rights of any sort, nor any exclusive privileges, nor does it authorize any injury to private property nor any invasion of personal rights, nor any infringement of Federal, State or local laws or regulations.
- 5.9. Severability. The provisions of this Permit are severable, and if any provision of this Permit, or the application of any provision of this Permit to any circumstance, is held invalid, the application of such provision to other circumstances, and the remainder of this Permit shall not be affected thereby.
- 5.10. Record Retention.
- 5.10.1. The Permittee shall retain copies of SWPPPs and all reports required by this Permit, and records of all data used to complete the Notice of Intent to be covered by this Permit, for a period of at least three years from the date that the site is finally stabilized. This period may be extended by request of the Executive Secretary at any time.
- 5.10.2. After final stabilization of the construction site is complete, the SWPPP is no longer required to be maintained on site, but may be maintained by the Permittee(s) at its primary headquarters. Access to the SWPPP will continue as described in Part 3.2, however.
- 5.11. Addresses. All written correspondence under this permit shall be directed to the Division of Water Quality at the following address:
- Department of Environmental Quality
Division of Water Quality
288 North 1460 West
PO Box 144870
Salt Lake City, Utah 84114-4870
- 5.12. State Laws.
- 5.12.1. Nothing in this Permit shall be construed to preclude the institution of any legal action or relieve the Permittee from any responsibilities, liabilities, or penalties established pursuant to any applicable State law or regulation under authority preserved by Utah Code Ann. § 19-5-117.
- 5.12.2. No condition of this Permit shall release the Permittee from any responsibility or requirements under other environmental statutes or regulations.
- 5.13. Proper Operation and Maintenance. The Permittee shall at all times properly operate and maintain all facilities and systems of treatment and control (and related appurtenances) which are installed or used by the Permittee to achieve compliance with the conditions

of this Permit and with the requirements of SWPPPs. Proper operation and maintenance also includes adequate laboratory controls and appropriate quality assurance procedures. Proper operation and maintenance requires the operation of backup or auxiliary facilities or similar systems, installed by a Permittee only when necessary to achieve compliance with the conditions of the Permit.

5.14. Inspection and Entry. The Permittee shall allow, upon presentation of credentials, the Executive Secretary or an authorized representative:

- 5.14.1. To enter upon the Permittee's premises where a regulated facility or activity is located or conducted or where records must be kept under the conditions of this Permit;
- 5.14.2. Have access to and copy at reasonable times, any records that must be kept under the conditions of this Permit;
- 5.14.3. Inspect at reasonable times any facilities, equipment (including monitoring and control equipment), practices, or operations regulated or required under this Permit; and
- 5.14.4. Sample or monitor at reasonable times, for the purposes of assuring permit compliance or as otherwise authorized by law, any substances or parameters at any location.

5.15. Reopener Clause.

- 5.15.1. Reopener Due to Water Quality Impacts. If there is evidence indicating that the storm water discharges authorized by this Permit cause, have the reasonable potential to cause or contribute to, a violation of a water quality standard, the discharger may be required to obtain an individual permit or an alternative general permit in accordance with Part 2.3 of this Permit or the Permit may be modified to include different limitations and/or requirements.
- 5.15.2. Reopener Guidelines. Permit modification or revocation will be conducted according to UAC R317-8-5.6 and UAC R317-8-6.2.
- 5.15.3. Permit Actions. This Permit may be modified, revoked and reissued, or terminated for cause. The filing of a request by the Permittee for a Permit modification, revocation and reissuance, or termination, or a notification of planned changes or anticipated noncompliance does not stay any Permit condition.

5.16. Signatory Requirements.

- 5.16.1. All Notices of Intent, SWPPPs, reports, certifications or information submitted to the Executive Secretary, or that this Permit requires be maintained by the Permittee, shall be signed as follows:
 - a. All Notices of Intent shall be signed as follows:
 - 1) For a corporation: by a responsible corporate officer. For the purpose of this section, a responsible corporate officer means: a president, secretary, treasurer, or vice-president of the corporation in charge of a principal business function, or any other person who performs similar policy or decision-making functions for the corporation; or the manager of one or more manufacturing, production or operating facilities employing more than 250 persons or having gross annual sales or expenditures exceeding \$25,000,000 (in second-quarter 1980 dollars) if authority to sign

- documents has been assigned or delegated to the manager in accordance with corporate procedures;
- 2) For a partnership or sole proprietorship: by a general partner or the proprietor, respectively; or
 - 3) For a municipality, State, Federal, or other public agency: by either a principal executive officer or ranking elected official. For purposes of this section, a principal executive officer of a Federal agency includes (1) the chief executive officer of the agency, or (2) a senior executive officer having responsibility for the overall operations of a principal geographic unit of the agency (e.g. Regional Administrators of EPA).
- b. All reports required by the Permit and other information requested by the Executive Secretary or by an authorized representative of the Executive Secretary shall be signed by a person described above or by a duly authorized representative of that person. A person is a duly authorized representative only if:
- 1) The authorization is made in writing by a person described above and submitted to the Executive Secretary; and
 - 2) The authorization specifies either an individual or a position having responsibility for overall operation of the regulated site, facility or activity, such as the position of manager, operator, superintendent, or position of equivalent responsibility or an individual or position having overall responsibility for environmental matters for the company. (A duly authorized representative may thus be either a named individual or any individual occupying a named position).
- c. Certification. Any person signing documents under this Part 5.16 shall make the following certification:

I certify under penalty of law that this document and all attachments were prepared under my direction or supervision in accordance with a system designed to assure that qualified personnel properly gathered and evaluated the information submitted. Based on my inquiry of the person or persons who manage the system, or those persons directly responsible for gathering the information, the information submitted is, to the best of my knowledge and belief, true, accurate, and complete. I am aware that there are significant penalties for submitting false information, including the possibility of fine and imprisonment for knowing violations.

- 5.16.2. If a document is to be signed electronically, the Division's rules regarding electronic transactions govern.

PART 6. DEFINITIONS

As used in this Permit:

- 6.1. "Act" means the "Utah Water Quality Act"
- 6.2. "Best Management Practices" ("BMPs") means schedules of activities, prohibitions of practices, maintenance procedures, and other management practices to prevent or reduce the discharge of pollutants to waters of the State. BMPs also include treatment requirements, operating procedures, and practices to control plant site runoff, spillage or leaks, sludge or waste disposal, or drainage from raw material storage.
- 6.3. "Common plan of development or sale" means one plan for development or sale, separate parts of which are related by any announcement, piece of documentation (including a sign, public notice or hearing, sales pitch, advertisement, drawing, plat, blueprint, contract, permit application, zoning request, computer design, etc.), physical demarcation (including boundary signs, lot stakes, surveyor markings, etc.), or continuing obligation (including contracts) that identify the scope of the project. A plan may still be a common plan of development or sale even if it is taking place in separate stages or phases, is planned in combination with other construction activities, or is implemented by different owners or operators.
- 6.4. "Commencement of Construction" means the initial disturbance of soils associated with clearing, grading, or excavating activities or other construction activities.
- 6.5. "Construction activity" means soil disturbing activities such as clearing, grading, and excavating of land. The term also includes construction support activities.
- 6.6. "Construction support activities" means construction material and equipment storage and maintenance, concrete or asphalt batch plants, except as provided in Part 1.4.3 of this Permit.
- 6.7. "Control Measure" refers to any Best Management Practice or other method used to prevent or reduce the discharge of pollutants to waters of the State.
- 6.8. "CWA" means Clean Water Act or the Federal Water Pollution Control Act.
- 6.9. "Dedicated portable asphalt plant" means a portable asphalt plant that is located on or contiguous to a construction site and that provides asphalt only to the construction site that the plant is located on or adjacent to.
- 6.10. "Dedicated portable concrete plant" means a portable concrete plant that is located on or contiguous to a construction site and that provides concrete only to the construction site that the plant is located on or adjacent to.
- 6.11. "Discharge," when used without qualification, means the discharge of a pollutant.

- 6.12. "EPA" means the United States Environmental Protection Agency.
- 6.13. "Eligible" means qualified for authorization to discharge storm water under this general permit.
- 6.14. "Executive Secretary" means Executive Secretary of the Utah Water Quality Board.
- 6.15. "Final Stabilization" means that all soil disturbing activities at the site have been completed, and that a uniform (e.g. evenly distributed, without large bare areas) perennial vegetative cover with a density of 70% of the native background vegetative cover for the area has been established on all unpaved areas and areas not covered by permanent structures, or equivalent permanent stabilization measures (such as the use of riprap, gabions, or geo-textiles) have been employed. In some parts of the country, background native vegetation will cover less than 100% of the ground (e.g. arid areas). Establishing at least 70% of the natural cover of native vegetation meets the vegetative cover criteria for final stabilization. For example, if the native vegetation covers 50% of the ground, 70% of 50% would require 35% total cover for final stabilization. For individual lots in residential construction, final stabilization means that either the homebuilder has completed final stabilization as specified above, or the homebuilder has established temporary stabilization including perimeter controls for an individual lot prior to occupation of the home by the homeowner and has obligated the homeowner, by contract, to complete the requirements for final stabilization within two years.
- 6.16. "Indian Country" is defined as in 40 CFR §122.2 to mean:
1. All land within the limits of any Indian reservation under the jurisdiction of the United States Government, notwithstanding the issuance of any patent, and, including rights-of-way running through the reservation;
 2. All dependent Indian communities within the borders of the United States whether within the originally or subsequently acquired territory thereof, and whether within or without the limits of a state; and
 3. All Indian allotments, the Indian titles to which have not been extinguished, including rights-of-ways running through the same.
- 6.17. "Municipal Separate Storm Sewer System" refers to all separate storm sewers that are owned or operated by the United States, a State, city, town, county, district, association, or other public body having jurisdiction over disposal of sewage, industrial wastes, storm water, or other wastes, including special districts under State law such as a sewer districts, flood control districts or drainage districts, or similar entity that discharges to waters of the State.
- 6.18. "NOI" means notice of intent to be covered by this Permit.
- 6.19. "NOT" means notice of termination.
- 6.20. "Point Source" means any discernible, confined, and discrete conveyance, including but not limited to, any pipe, ditch, channel, tunnel, conduit, well, discrete fissure, container, rolling stock, concentrated animal feeding operation, landfill leachate collection system,

vessel or other floating craft from which pollutants are or may be discharged. This term does not include return flows from irrigated agriculture or agricultural storm water runoff.

- 6.21. "Runoff coefficient" means the fraction of total rainfall that will appear at conveyance as runoff.
- 6.22. "Site" means the land or water area where any "facility or activity" is physically located or conducted, including adjacent land used in connection with the facility or activity.
- 6.23. "Storm water" means storm water runoff, snow melt runoff, and surface runoff and drainage.
- 6.24. "Storm water discharge associated with industrial activity" is defined in the Utah Administrative Code (UAC) R317-8-3.9(6)(c) & (d) and incorporated here by reference. Most relevant to this Permit is UAC R317-8-3.9(6)(d)10, which relates to construction activity including clearing, grading and excavation activities.
- 6.25. SWPPP means Storm Water Pollution Prevention Plan, referring to the plan required in Part 3 of this Permit.
- 6.26. "Total Maximum Daily Load" or "TMDL" means the sum of the individual wasteload allocations (WLAs) for point sources and load allocations (LAs) for nonpoint sources and natural background. If a receiving water has only one point source discharger, the TMDL is the sum of that point source WLA plus the LAs for any nonpoint sources of pollution and natural background sources, tributaries, or adjacent segments. TMDLs can be expressed in terms of either mass per time, toxicity, or other appropriate measure.
- 6.27. Waters of the State means all streams, lakes, ponds, marshes, water-courses, waterways, wells, springs, irrigation systems, drainage systems, and all other bodies or accumulations of water, surface and underground, natural or artificial, public or private, which are contained within, flow through, or border upon this state or any portion thereof, except that bodies of water confined to and retained within the limits of private property, and which do not develop into or constitute a nuisance, or a public health hazard, or a menace to fish and wildlife, shall not be considered to be waters of the state (UAC R317-1-1.31).

APPENDIX B

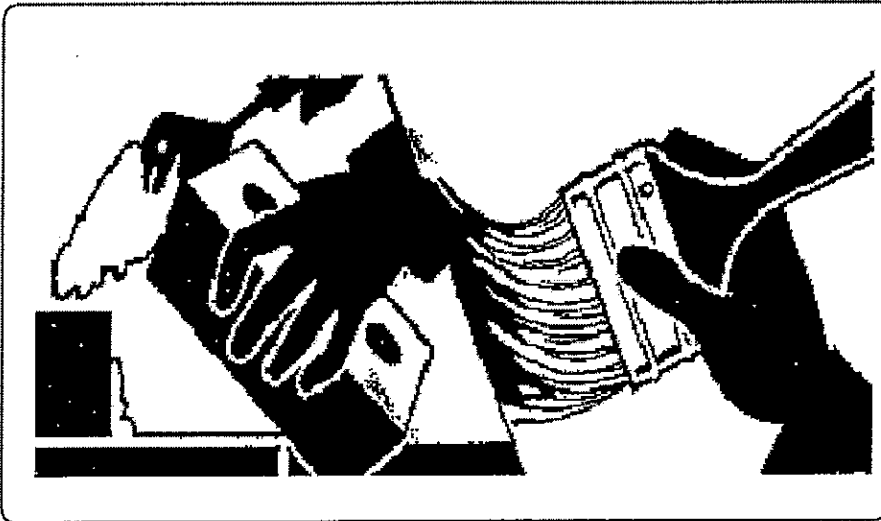

- OBJECTIVES**
- New Development
 - Residential
 - Commercial Activities
 - Industrial Activities
 - Municipal Facilities
 - Illegal Discharges



WEBER COUNTY

ENGINEERING DEPARTMENT
 2380 Washington Blvd., Suite 240
 Ogden, UT 84401
 (801) 399-8374

DESCRIPTION:

Prevent or reduce the discharge of pollutants to stormwater from building repair, remodeling and construction by using soil erosion controls, enclosing or covering building material storage areas, using good housekeeping practices, using safer alternative products, and training employees.

APPROACH:

- ▶ Use soil erosion control techniques if bare ground is temporarily exposed.
- ▶ Use permanent soil erosion control techniques if the remodeling clears buildings that are not to be replaced.
- ▶ Enclose painting operations consistent with local air quality regulations and OSHA.
- ▶ Properly store materials that are normally used in repair and remodeling such as paints and solvents.
- ▶ Properly store and dispose waste materials generated from the activity.
- ▶ Maintain good housekeeping practices while work is underway.

LIMITATIONS:

- ▶ This BMP is for minor construction only.
- ▶ Hazardous waste that cannot be re-used or recycled must be disposed of by a licensed hazardous waste hauler.
- ▶ Safer alternative products may not be available, suitable, or effective in every case.
- ▶ Be certain that actions to help stormwater quality are consistent with OSHA and air quality regulations.

- TARGETED POLLUTANTS**
- Sediment
 - Nutrients
 - Heavy Metals
 - Toxic Materials
 - Oxygen Demanding Substance
 - Oil & Grease
 - Floatable Materials
 - Bacteria & Viruses
 - High Impact
 - Medium Impact
 - Low or Unknown Impact

- IMPLEMENTATION REQUIREMENTS**
- Capital Costs
 - O&M Costs
 - Regulatory
 - Training
 - Staffing
 - Administrative
 - High
 - Medium
 - Low

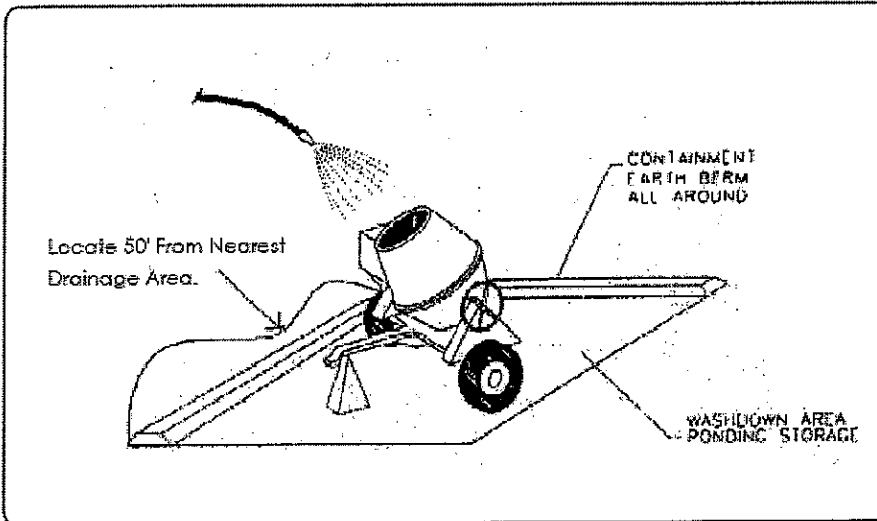

DESCRIPTION:

Prevent or reduce the discharge of pollutants to storm water from concrete waste by conducting washout off-site, performing on-site washout in a designated area, and training employees and subcontractors.

APPLICATIONS:

- ▶ This technique is applicable to all types of sites.

INSTALLATION/APPLICATION CRITERIA:

- ▶ Store dry and wet materials under cover, away from drainage areas.
- ▶ Avoid mixing excess amounts of fresh concrete or cement on-site.
- ▶ Perform washout of concrete trucks off-site or in designated areas only.
- ▶ Do not wash out concrete trucks into storm drains, open ditches, streets, or streams.
- ▶ Do not allow excess concrete to be dumped on-site, except in designated areas.
- ▶ When washing concrete to remove fine particles and expose the aggregate, avoid creating runoff by draining the water within a bermed or level area. (See Earth Berm Barrier information sheet.)
- ▶ Train employees and subcontractors in proper concrete waste management.

LIMITATIONS:

- ▶ Off-site washout of concrete wastes may not always be possible.

MAINTENANCE:

- ▶ Inspect subcontractors to ensure that concrete wastes are being properly managed.
- ▶ If using a temporary pit, dispose hardened concrete on a regular basis.

OBJECTIVES

- Housekeeping Practices
- Contain Waste
- Minimize Disturbed Areas
- Stabilize Disturbed Areas
- Protect Slopes/Channels
- Control Site Perimeter
- Control Internal Erosion



WEBER COUNTY

ENGINEERING DEPARTMENT

2380 Washington Blvd., Suite 240
Ogden, UT 84401
(801) 399-8374

TARGETED POLLUTANTS

- Sediment
- Nutrients
- Toxic Materials
- Oil & Grease
- Floatable Materials
- Other Construction Waste

- High Impact
- Medium Impact
- Low or Unknown Impact

IMPLEMENTATION REQUIREMENTS

- Capital Costs
- O&M Costs
- Maintenance
- Training

- High
- Medium
- Low

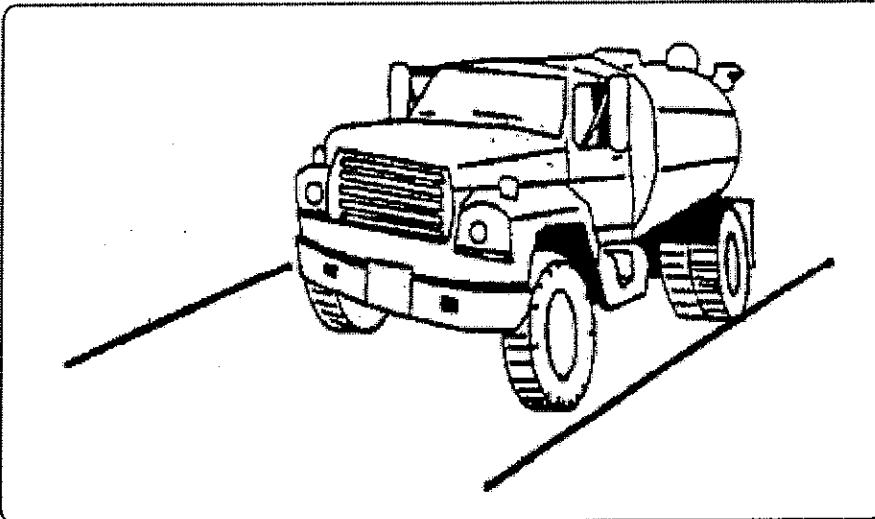
**DESCRIPTION:**

Dust control measures are used to stabilize soil from wind erosion, and reduce dust by construction activities.

APPLICATION:

- ▶ Dust control is useful in any process area, loading and unloading area, material handling areas, and transfer areas where dust is generated. Street sweeping is limited to areas that are paved.

INSTALLATION/APPLICATION CRITERIA:

- ▶ Mechanical dust collection systems are designed according to the size of dust particles and the amount of air to be processed. Manufacturers' recommendations should be followed for installation (as well as the design of the equipment).
- ▶ Two kinds of street sweepers are common: brush and vacuum. Vacuum sweepers are more efficient and work best when the area is dry.
- ▶ Mechanical equipment should be operated according to the manufacturers' recommendations and should be inspected regularly.

LIMITATIONS:

- ▶ Is generally more expensive than manual systems.
- ▶ May be impossible to maintain by plant personnel (the more elaborate equipment).
- ▶ Is labor and equipment intensive and may not be effective for all pollutants (street sweepers).

MAINTENANCE:

- ▶ If water sprayers are used, dust-contaminated waters should be collected and taken
- ▶ for treatment. Areas will probably need to be resprayed to keep dust from spreading.

OBJECTIVES

- Housekeeping Practices
- Contain Waste
- Minimize Disturbed Areas
- Stabilize Disturbed Areas
- Protect Slopes/Channels
- Control Site Perimeter
- Control Internal Erosion

**WEBER COUNTY****ENGINEERING DEPARTMENT**

2380 Washington Blvd., Suite 240
Ogden, UT 84401
(801) 399-8374

TARGETED POLLUTANTS

- Sediment
- Nutrients
- Toxic Materials
- Oil & Grease
- Floatable Materials
- Other Waste

- High Impact
- Medium Impact
- Low or Unknown Impact

IMPLEMENTATION REQUIREMENTS

- Capital Costs
- O&M Costs
- Maintenance
- Training

- High
- Medium
- Low

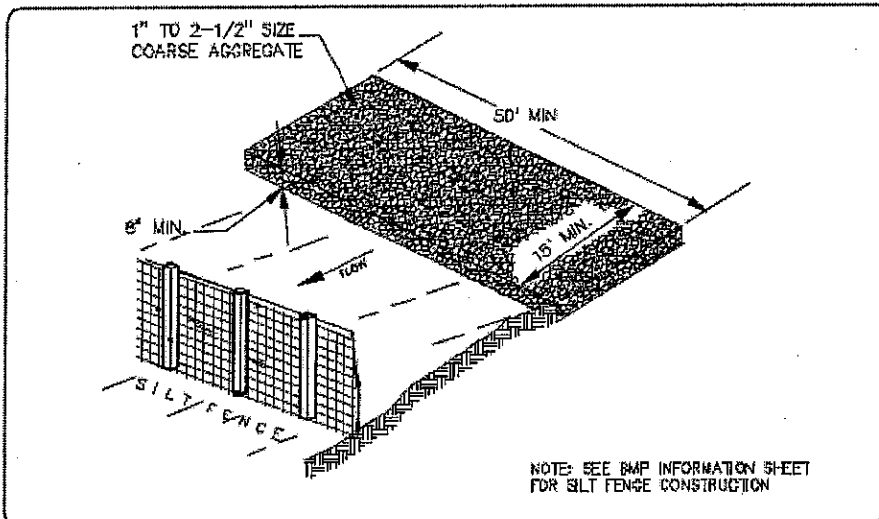

DESCRIPTION:

A stabilized pad of crushed stone for general washing of equipment and construction vehicles.

APPLICATION:

- ▶ At any site where regular washing of vehicles and equipment will occur. May also be used as a filling point for water trucks limiting erosion caused by overflow or spillage of water.

INSTALLATION/APPLICATION CRITERIA:

- ▶ Clear and grub area and grade to provide maximum slope of 1%
- ▶ Compact subgrade and place filter fabric if desired (recommended for wash areas to remain in use for more than 3 months).
- ▶ Place coarse aggregate, 1 to 2-1/2 inches in size, to a minimum depth of 8-inches.
- ▶ Install silt fence downgradient (see silt fence BMP information sheet).

LIMITATIONS:

- ▶ Cannot be utilized for washing equipment or vehicles that may cause contamination of runoff such as fertilizer equipment or concrete equipment. Solely used to control sediment in wash water.

MAINTENANCE:

- ▶ Inspect daily for loss of gravel or sediment buildup.
- ▶ Inspect adjacent area for sediment deposit and install additional controls as necessary.
- ▶ Repair area and replace gravel as required to maintain control in good working condition.
- ▶ Expand stabilized area as required to accommodate activities.
- ▶ Maintain silt fence as outlined in specific silt fence BMP information sheet.

OBJECTIVES

- Housekeeping Practices
- Contain Waste
- Minimize Disturbed Areas
- Stabilize Disturbed Areas
- Protect Slopes/Channels
- Control Site Perimeter
- Control Internal Erosion



WEBER COUNTY

ENGINEERING DEPARTMENT

2380 Washington Blvd., Suite 240
Ogden, UT 84401
(801) 399-8374

TARGETED POLLUTANTS

- Sediment
- Nutrients
- Toxic Materials
- Oil & Grease
- Floatable Materials
- Other Waste

- High Impact
- Medium Impact
- Low or Unknown Impact

IMPLEMENTATION REQUIREMENTS

- Capital Costs
- O&M Costs
- Maintenance
- Training

- High
- Medium
- Low



DESCRIPTION:

Prevent or reduce the discharge of pollutants to stormwater from hazardous waste through proper material use, waste disposal, and training of employees and subcontractors.

APPLICATION:

Many of the chemicals used on-site can be hazardous materials which become hazardous waste upon disposal. These wastes may include:

- ▶ Paints and solvents; petroleum products such as oils; fuels and greases; herbicides and pesticides; acids for cleaning masonry; and concrete curing compounds.

In addition, sites with existing structures may contain wastes which must be disposed of in accordance with federal, state and local regulations, including:

- ▶ Sandblasting grit mixed with lead, cadmium or chromium based paints, asbestos, and PCBs.

INSTALLATION/APPLICATION CRITERIA:

The following steps will help reduce stormwater pollution from hazardous wastes:

- ▶ Use the entire product before disposing of the container.
- ▶ Do not remove the original product label; it contains important safety and disposal information.
- ▶ Do not over-apply herbicides and pesticides. Prepare only the amount needed. Follow the recommended usage instructions. Over-application is expensive and environmentally harmful. Apply surface dressings in several smaller applications, as opposed to one large application, to allow time for infiltration and to avoid excess material being carried off-site by runoff. Do not apply these chemicals just before it rains. People applying pesticides must be certified in accordance with federal and state regulations.

LIMITATIONS:

- ▶ Hazardous waste that cannot be reused or recycled must be disposed of by a licensed hazardous waste collector.

MAINTENANCE:

- ▶ Inspect hazardous waste receptacles and areas regularly.
- ▶ Arrange for regular hazardous waste collection.

OBJECTIVES

- New Development
- Residential
- Commercial Activities
- Industrial Activities
- Municipal Facilities
- Illegal Discharges



WEBER COUNTY

ENGINEERING DEPARTMENT

2380 Washington Blvd., Suite 240
Ogden, UT 84401
(801) 399-8374

TARGETED POLLUTANTS

- Sediment
- Nutrients
- Heavy Metals
- Toxic Materials
- Oxygen Demanding Substance
- Oil & Grease
- Floatable Materials
- Bacteria & Viruses
- High Impact
- Medium Impact
- Low or Unknown Impact

IMPLEMENTATION REQUIREMENTS

- Capital Costs
- O&M Costs
- Regulatory
- Training
- Staffing
- Administrative
- High
- Medium
- Low

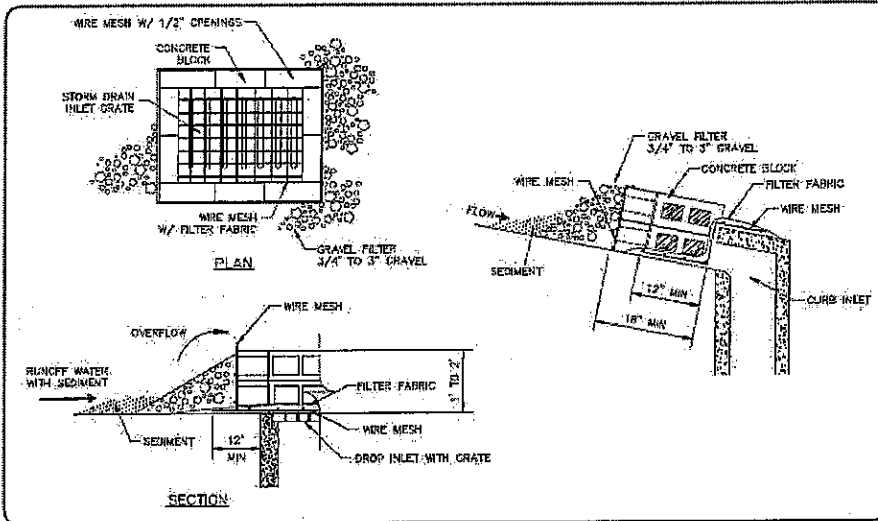

- ### OBJECTIVES
- Housekeeping Practices
 - Contain Waste
 - Minimize Disturbed Areas
 - Stabilize Disturbed Areas
 - Protect Slopes/Channels
 - Control Site Perimeter
 - Control Internal Erosion



WEBER COUNTY

ENGINEERING DEPARTMENT
 2380 Washington Blvd., Suite 240
 Ogden, UT 84401
 (801) 399-8374

DESCRIPTION:

Concrete block and gravel filter placed over inlet to storm drain system.

APPLICATION:

- ▶ Construct at inlets in paved or unpaved areas where upgradient area is to be disturbed by construction activities.

INSTALLATION/APPLICATION CRITERIA:

- ▶ Place wire mesh (with 1/2 inch openings) over the inlet grate extending one foot past the grate in all directions.
- ▶ Place concrete blocks around the inlet with openings facing outward. Stack blocks to minimum height of 12-inches and maximum height of 24-inches.
- ▶ Place wire mesh around outside of blocks.
- ▶ Place gravel (3/4" to 3") around blocks.

LIMITATIONS:

- ▶ Recommended for maximum drainage area of one acre.
- ▶ Excess flows may bypass the inlet requiring down gradient controls.
- ▶ Ponding will occur at inlet.

MAINTENANCE:

- ▶ Inspect inlet protection after every large storm event and at a minimum of once monthly.
- ▶ Remove sediment accumulated when it reaches 4-inches in depth.
- ▶ Replace filter fabric and clean or replace gravel if clogging is apparent.

- ### TARGETED POLLUTANTS
- Sediment
 - Nutrients
 - Toxic Materials
 - Oil & Grease
 - Floatable Materials
 - Other Waste
-
- High Impact
 - Medium Impact
 - Low or Unknown Impact

- ### IMPLEMENTATION REQUIREMENTS
- Capital Costs
 - O&M Costs
 - Maintenance
 - Training
-
- High
 - Medium
 - Low

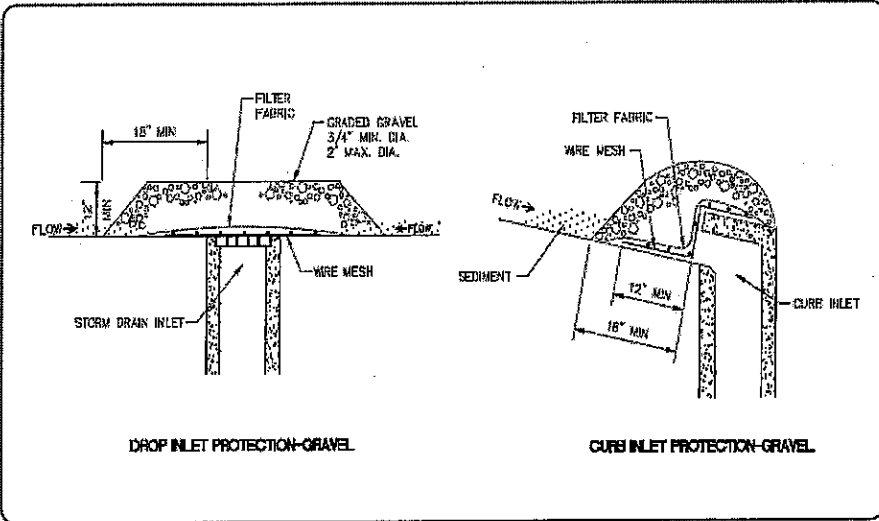

- OBJECTIVES**
- Housekeeping Practices
 - Contain Waste
 - Minimize Disturbed Areas
 - Stabilize Disturbed Areas
 - Protect Slopes/Channels
 - Control Site Perimeter
 - Control Internal Erosion

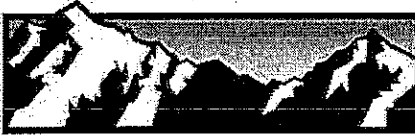

WEBER COUNTY

ENGINEERING DEPARTMENT
 2380 Washington Blvd., Suite 240
 Ogden, UT 84401
 (801) 399-8374

DESCRIPTION:

Placement of gravel filter over inlet to storm drains to filter storm water runoff.

APPLICATION:

- ▶ Construct at inlets in paved or unpaved areas where upgradient area is to be disturbed by construction activities.

INSTALLATION/APPLICATION CRITERIA:

- ▶ Place wire mesh (with 1/2 inch openings) over the inlet grate extending one foot past the grate in all directions.
- ▶ Place filter fabric over the mesh. Filter fabric should be selected based on soil type.
- ▶ Place graded gravel, to a minimum depth of 12-inches, over the filter fabric and extending 18-inches past the grate in all directions.

LIMITATIONS:

- ▶ Recommended for maximum drainage area of one acre.
- ▶ Excess flows may bypass the inlet requiring down gradient controls.
- ▶ Ponding will occur at inlet.

MAINTENANCE:

- ▶ Inspect inlet protection after every large storm event and at a minimum of once monthly.
- ▶ Remove sediment accumulated when it reaches 4-inches in depth.
- ▶ Replace filter fabric and clean or replace gravel if clogging is apparent.

- TARGETED POLLUTANTS**
- Sediment
 - Nutrients
 - Toxic Materials
 - Oil & Grease
 - Floatable Materials
 - Other Waste
-
- High Impact
 - Medium Impact
 - Low or Unknown Impact

- IMPLEMENTATION REQUIREMENTS**
- Capital Costs
 - O&M Costs
 - Maintenance
 - Training
-
- High
 - Medium
 - Low

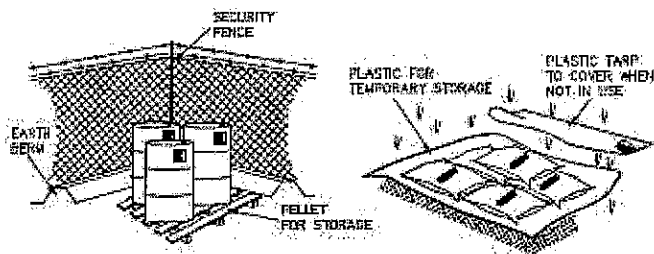

- ▶ CONTROLLED STORAGE LOCATION
- ▶ BERMED PERIMETER IMPOUNDMENT
- ▶ STORAGE OFF GROUND
- ▶ COVER WHEN NOT IN USE

OBJECTIVES

- Housekeeping Practices
- Contain Waste
- Minimize Disturbed Areas
- Stabilize Disturbed Areas
- Protect Slopes/Channels
- Control Site Perimeter
- Control Internal Erosion



WEBER COUNTY

ENGINEERING DEPARTMENT

2380 Washington Blvd., Suite 240
Ogden, UT 84401
(801) 399-8374

DESCRIPTION:

Controlled storage of on-site materials.

APPLICATION:

- ▶ Storage of hazardous, toxic, and all chemical substances.
- ▶ Any construction site with outside storage of materials.

INSTALLATION/APPLICATION CRITERIA:

- ▶ Designate a secured area with limited access as the storage location. Ensure no waterways or drainage paths are nearby.
- ▶ Construct compacted earthen berm (See Earth Berm Barrier Information Sheet), or similar perimeter containment around storage location for impoundment in the case of spills.
- ▶ Ensure all on-site personnel utilize designated storage area. Do not store excessive amounts of material that will not be utilized on site.
- ▶ For active use of materials away from the storage area ensure materials are not set directly on the ground and are covered when not in use. Protect storm drainage during use.

LIMITATIONS:

- ▶ Does not prevent contamination due to mishandling of products.
- ▶ Spill Prevention and Response Plan still required.
- ▶ Only effective if materials are actively stored in controlled location.

MAINTENANCE:

- ▶ Inspect daily and repair any damage to perimeter impoundment or security fencing.
- ▶ Check materials are being correctly stored (i.e. standing upright, in labeled containers, tightly capped) and that no materials are being stored away from the designated location.

TARGETED POLLUTANTS

- Sediment
- Nutrients
- Toxic Materials
- Oil & Grease
- Floatable Materials
- Other Construction Waste

- High Impact
- Medium Impact
- Low or Unknown Impact

IMPLEMENTATION REQUIREMENTS

- Capital Costs
- O&M Costs
- Maintenance
- Training

- High
- Medium
- Low



- OBJECTIVES**
- Housekeeping Practices
 - Contain Waste
 - Minimize Disturbed Areas
 - Stabilize Disturbed Areas
 - Protect Slopes/Channels
 - Control Site Perimeter
 - Control Internal Erosion



WEBER COUNTY

ENGINEERING DEPARTMENT

2380 Washington Blvd., Suite 240
 Ogden, UT 84401
 (801) 399-8374

DESCRIPTION:

Prevent or reduce the discharge of pollutants to storm water from material use by using alternative products, minimizing hazardous material use on-site, and training employees and subcontractors.

APPLICATION:

- The following materials are commonly used on construction sites:
- ▶ Pesticides and herbicides, fertilizers, detergents, plaster and other products, petroleum products such as fuel, oil, and grease.
 - ▶ Other hazardous chemicals such as acids, lime, glues, paints, solvents, and curing compounds.

INSTALLATION/APPLICATION CRITERIA:

- ▶ Use less hazardous, alternative materials as much as possible.
- ▶ Minimize use of hazardous materials on-site.
- ▶ Use only materials where and when needed to complete the construction activity.
- ▶ Follow manufacturer's instructions regarding uses, protective equipment, ventilation, flammability, and mixing of chemicals.
- ▶ Personnel who use pesticides should be trained in their use.
- ▶ Do not over apply fertilizers, herbicides, and pesticides. Prepare only the amount needed.
- ▶ Unless on steep slopes, till fertilizers in to the soil rather than hydroseeding.
- ▶ Do not apply these chemicals just before it rains.

LIMITATIONS:

- ▶ Alternative materials may not be available, suitable, or effective in every case.

MAINTENANCE:

- ▶ Maintenance of this best management practice is minimal.

- TARGETED POLLUTANTS**
- Sediment
 - Nutrients
 - Toxic Materials
 - Oil & Grease
 - Floatable Materials
 - Other Construction Waste
-
- High Impact
 - Medium Impact
 - Low or Unknown Impact

- IMPLEMENTATION REQUIREMENTS**
- Capital Costs
 - O&M Costs
 - Maintenance
 - Training
-
- High
 - Medium
 - Low

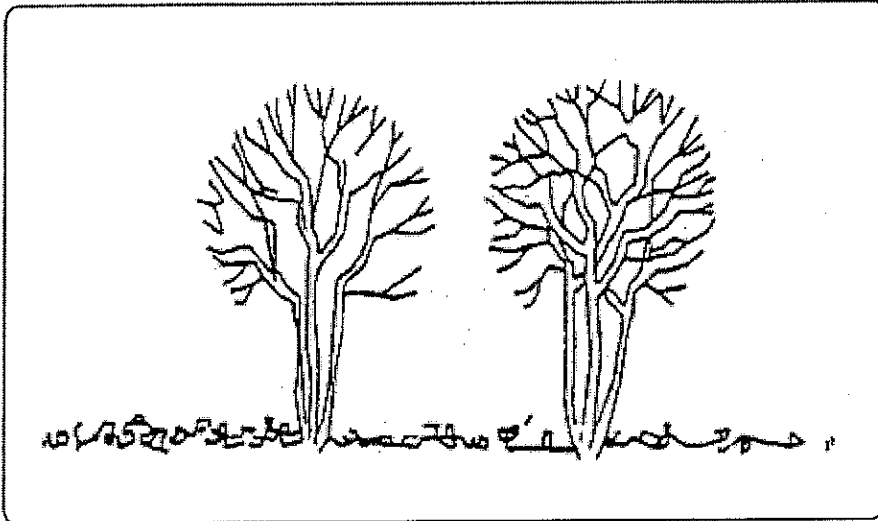

- ### OBJECTIVES
- Housekeeping Practices
 - Contain Waste
 - Minimize Disturbed Areas
 - Stabilize Disturbed Areas
 - Protect Slopes/Channels
 - Control Site Perimeter
 - Control Internal Erosion



WEBER COUNTY

ENGINEERING DEPARTMENT
 2380 Washington Blvd., Suite 240
 Ogden, UT 84401
 (801) 399-8374

DESCRIPTION:

Carefully planned preservation of existing vegetation minimizes the potential of removing or injuring existing trees, vines, shrubs and/or grasses that serve as erosion controls.

APPLICATIONS:

- ▶ This technique is applicable to all types of sites. Areas where preserving vegetation can be particularly beneficial are floodplains, wetlands, stream banks, steep slopes, and other areas where erosion controls would be difficult to establish, install, or maintain.

INSTALLATION/APPLICATION CRITERIA:

- ▶ Clearly mark, flag or fence vegetation or areas where vegetation should be preserved.
- ▶ Prepare landscaping plans which include as much existing vegetation as possible and state proper care during and after construction.
- ▶ Define and protect with berms, fencing, signs, etc. a setback area from vegetation to be preserved.
- ▶ Propose landscaping plans which do not include plant species that compete with the existing vegetation.
- ▶ Do not locate construction traffic routes, spoil piles, etc. where significant adverse impact on existing vegetation may occur.

LIMITATIONS:

- ▶ Requires forward planning by the owner/developer, contractor and design staff.
- ▶ For sites with diverse topography, it is often difficult and expensive to save existing trees while grading the site satisfactorily for the planned development.
- ▶ May not be cost effective with high land costs.

MAINTENANCE:

- ▶ Inspection and maintenance requirements for protection of vegetation are low.
- ▶ Maintenance of native trees or vegetation should conform to landscape plan specifications.

- ### TARGETED POLLUTANTS
- Sediment
 - Nutrients
 - Toxic Materials
 - Oil & Grease
 - Floatable Materials
 - Other Waste
-
- High Impact
 - Medium Impact
 - Low or Unknown Impact

- ### IMPLEMENTATION REQUIREMENTS
- Capital Costs
 - O&M Costs
 - Maintenance
 - Training
-
- High
 - Medium
 - Low

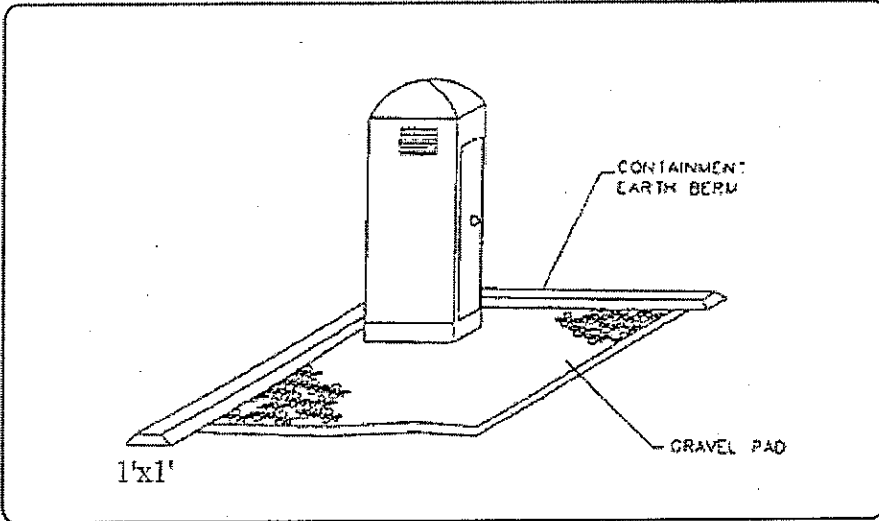

DESCRIPTION:

Temporary on-site sanitary facilities for construction personnel.

APPLICATION:

- ▶ All sites with no permanent sanitary facilities or where permanent facility is too far from activities.

INSTALLATION/APPLICATION CRITERIA:

- ▶ Locate portable toilets in convenient locations throughout the site.
- ▶ Prepare level, gravel surface and provide clear access to the toilets for servicing and for on-site personnel.
- ▶ Construct earth berm perimeter (See Earth Berm Barrier Information Sheet), control for spill/protection leak.

LIMITATIONS:

No limitations.

MAINTENANCE:

- ▶ Portable toilets should be maintained in good working order by licensed service with daily observation for leak detection.
- ▶ Regular waste collection should be arranged with licensed service.
- ▶ All waste should be deposited in sanitary sewer system for treatment with appropriate agency approval.

OBJECTIVES

- Housekeeping Practices
- Contain Waste
- Minimize Disturbed Areas
- Stabilize Disturbed Areas
- Protect Slopes/Channels
- Control Site Perimeter
- Control Internal Erosion



WEBER COUNTY

ENGINEERING DEPARTMENT

2380 Washington Blvd., Suite 240
Ogden, UT 84401
(801) 399-8374

TARGETED POLLUTANTS

- Sediment
- Nutrients
- Toxic Materials
- Oil & Grease
- Floatable Materials
- Other Construction Waste

- High Impact
- Medium Impact
- Low or Unknown Impact

IMPLEMENTATION REQUIREMENTS

- Capital Costs
- O&M Costs
- Maintenance
- Training

- High
- Medium
- Low

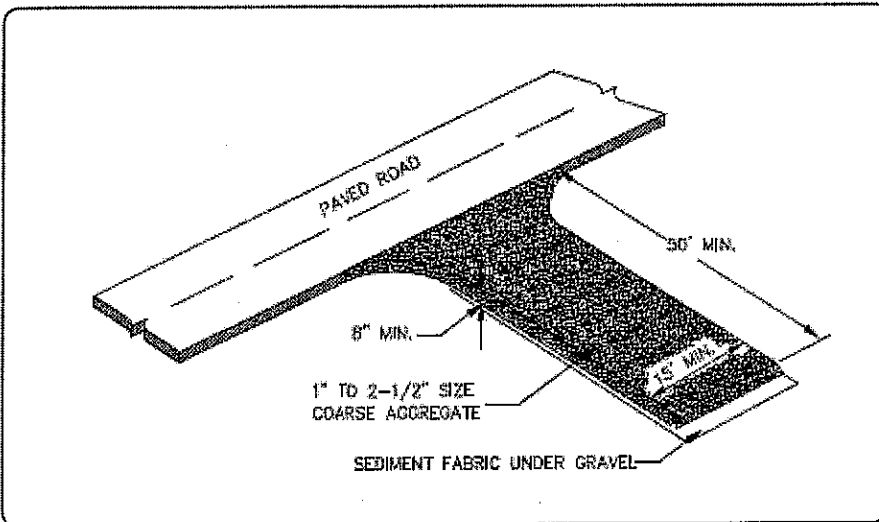

DESCRIPTION:

A stabilized pad of crushed stone located where construction traffic enters or leaves the site from or to paved surface.

APPLICATIONS:

- ▶ At any point of ingress or egress at a construction site where adjacent traveled way is paved. Generally applies to sites over 2 acres unless special conditions exist.

INSTALLATION/APPLICATION CRITERIA:

- ▶ Clear and grub area and grade to provide maximum slope of 2%.
- ▶ Compact subgrade and place filter fabric if desired (recommended for entrances to remain for more than 3 months).
- ▶ Place coarse aggregate, 1 to 2-1/2 inches in size, to a minimum depth of 8 inches.

LIMITATIONS:

- ▶ Requires periodic top dressing with additional stones.
- ▶ Should be used in conjunction with street sweeping on adjacent public right-of-way.

MAINTENANCE:

- ▶ Inspect daily for loss of gravel or sediment buildup.
- ▶ Inspect adjacent roadway for sediment deposit and clean by sweeping or shoveling.
- ▶ Repair entrance and replace gravel as required to maintain control in good working condition.
- ▶ Expand stabilized area as required to accommodate traffic and prevent erosion at driveways.

OBJECTIVES

- Housekeeping Practices
- Contain Waste
- Minimize Disturbed Areas
- Stabilize Disturbed Areas
- Protect Slopes/Channels
- Control Site Perimeter
- Control Internal Erosion

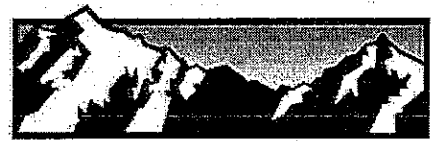

WEBER COUNTY

ENGINEERING DEPARTMENT

2380 Washington Blvd., Suite 240
Ogden, UT 84401
(801) 399-8374

TARGETED POLLUTANTS

- Sediment
- Nutrients
- Toxic Materials
- Oil & Grease
- Floatable Materials
- Other Waste

- High Impact
- Medium Impact
- Low or Unknown Impact

IMPLEMENTATION REQUIREMENTS

- Capital Costs
- O&M Costs
- Maintenance
- Training

- High
- Medium
- Low

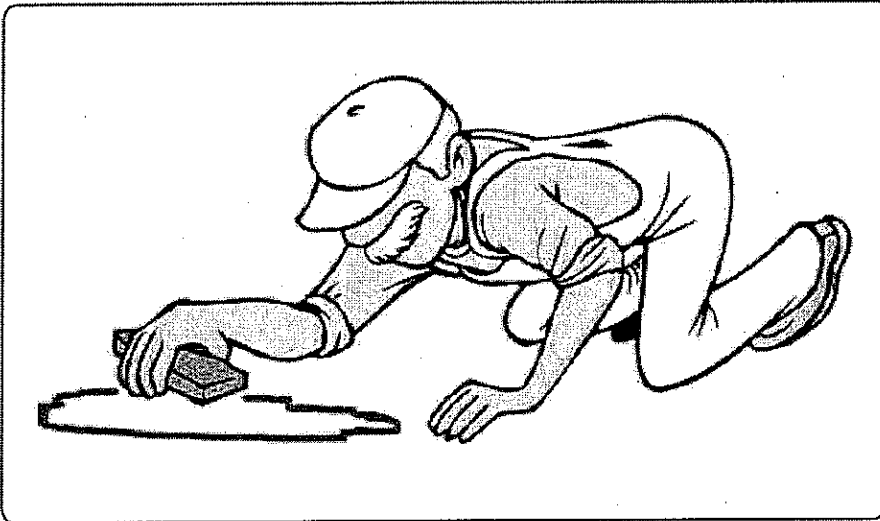

- OBJECTIVES**
- Housekeeping Practices
 - Contain Waste
 - Minimize Disturbed Areas
 - Stabilize Disturbed Areas
 - Protect Slopes/Channels
 - Control Site Perimeter
 - Control Internal Erosion

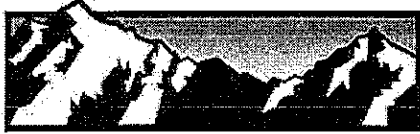

WEBER COUNTY

ENGINEERING DEPARTMENT

2380 Washington Blvd., Suite 240
 Ogden, UT 84401
 (801) 399-8374

DESCRIPTION:

Practices to clean-up leakage/spillage of on-site materials that may be harmful to receiving waters.

APPLICATION:

- ▶ All sites

GENERAL:

- ▶ Store controlled materials within a storage area.
- ▶ Educate personnel on prevention and clean-up techniques.
- ▶ Designate an Emergency Coordinator responsible for employing preventative practices and for providing spill response.
- ▶ Maintain a supply of clean-up equipment on-site and post a list of local response agencies with phone numbers.

METHODS:

- ▶ Clean-up spills/leaks immediately and remediate cause.
- ▶ Use as little water as possible. NEVER HOSE DOWN OR BURY SPILL CONTAMINATED MATERIAL.
- ▶ Use rags or absorbent material for clean-up. Excavate contaminated soils. Dispose of clean-up material and soil as hazardous waste.
- ▶ Document all spills with date, location, substance, volume, actions taken and other pertinent data.
- ▶ Contact local Fire Department and State Division of Environmental Response and Remediation (Phone #536-4100) for any spill of reportable quantity.

- TARGETED POLLUTANTS**
- Sediment
 - Nutrients
 - Toxic Materials
 - Oil & Grease
 - Floatable Materials
 - Other Construction Waste
-
- High Impact
 - Medium Impact
 - Low or Unknown Impact

- IMPLEMENTATION REQUIREMENTS**
- Capital Costs
 - O&M Costs
 - Maintenance
 - Training
-
- High
 - Medium
 - Low

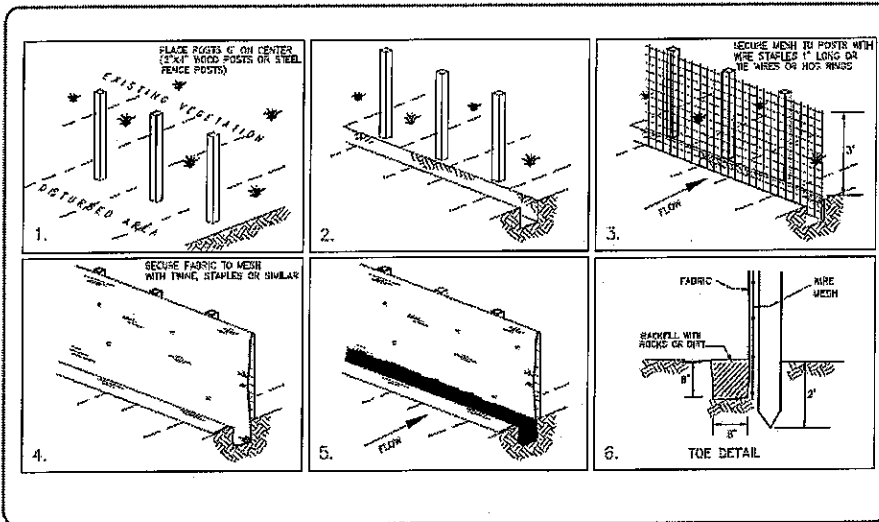

DESCRIPTION:

- ▶ A temporary sediment barrier consisting of entrenched filter fabric stretched across and secured to supporting posts.

APPLICATION:

- ▶ Perimeter control: place barrier at downgradient limits of disturbance
- ▶ Sediment barrier: place barrier at toe of slope or soil stockpile
- ▶ Protection of existing waterways: place barrier at top of stream bank
- ▶ Inlet protection: place fence surrounding catchbasins

INSTALLATION/APPLICATION CRITERIA:

- ▶ Place posts 6 feet apart on center along contour (or use preassembled unit) and drive 2 feet minimum into ground. Excavate an anchor trench immediately upgradient of posts.
- ▶ Secure wire mesh (14 gage min. With 6 inch openings) to upslope side of posts. Attach with heavy duty 1 inch long wire staples, tie wires or hog rings.
- ▶ Cut fabric to required width, unroll along length of barrier and drape over barrier. Secure fabric to mesh with twine, staples, or similar, with trailing edge extending into anchor trench.
- ▶ Backfill trench over filter fabric to anchor.

LIMITATIONS:

- ▶ Recommended maximum drainage area of 0.5 acre per 100 feet of fence
- ▶ Recommended maximum upgradient slope length of 150 feet
- ▶ Recommended maximum uphill grade of 2:1 (50%)
- ▶ Recommended maximum flow rate of 0.5 cfs
- ▶ Ponding should not be allowed behind fence

MAINTENANCE:

- ▶ Inspect immediately after any rainfall and at least daily during prolonged rainfall.
- ▶ Look for runoff bypassing ends of barriers or undercutting barriers.
- ▶ Repair or replace damaged areas of the barrier and remove accumulated sediment.
- ▶ Reanchor fence as necessary to prevent shortcutting.
- ▶ Remove accumulated sediment when it reaches 1/2 the height of the fence.

OBJECTIVES

- Housekeeping Practices
- Contain Waste
- Minimize Disturbed Areas
- Stabilize Disturbed Areas
- Protect Slopes/Channels
- Control Site Perimeter
- Control Internal Erosion



WEBER COUNTY

ENGINEERING DEPARTMENT

2380 Washington Blvd., Suite 240
 Ogden, UT 84401
 (801) 399-8374

TARGETED POLLUTANTS

- Sediment
- Nutrients
- Toxic Materials
- Oil & Grease
- Floatable Materials
- Other Waste

- High Impact
- Medium Impact
- Low or Unknown Impact

IMPLEMENTATION REQUIREMENTS

- Capital Costs
- O&M Costs
- Maintenance
- Training

- High
- Medium
- Low

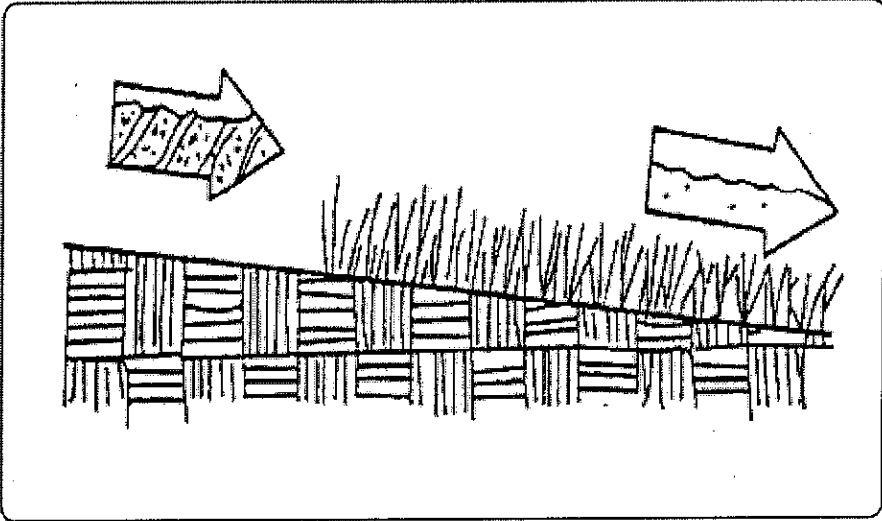

DESCRIPTION:

- ▶ Seeding of grass and plantings of trees, shrubs, vines and ground covers provide long-term stabilization of soil. In some areas, with suitable climates, grasses can be planted for temporary stabilization.

APPLICATION:

- ▶ Appropriate for site stabilization both during and after construction
- ▶ Any graded/cleared areas where construction activities have ceased.
- ▶ Open space cut and fill areas.
- ▶ Steep slopes, spoil piles, vegetated swales, landscape corridors, stream banks.

INSTALLATION/APPLICATION CRITERIA:

Type of vegetation, site and seedbed preparation, planting time, fertilization and water requirements should be considered for each application. Grasses:

- ▶ Ground preparation: fertilize and mechanically stabilize the soil.
- ▶ Tolerant of short-term temperature extremes and waterlogged soil composition.
- ▶ Appropriate soil conditions: shallow soil base, good drainage, slope 2:1 or flatter.
- ▶ Mowing, irrigating, and fertilizing are vital for promoting vigorous grass growth.

Trees and Shrubs:

- ▶ Selection criteria: vigor, species, size, shape & wildlife food source.
- ▶ Soil conditions: select species appropriate for soil, drainage & acidity.
- ▶ Other factors: wind/exposure, temperature extremes, and irrigation needs.

Vines and Ground Covers:

- ▶ Ground preparation: lime and fertilizer preparation.
- ▶ Use proper seeding rates.
- ▶ Appropriate soil conditions: drainage, acidity and slopes.
- ▶ Generally avoid species requiring irrigation.

LIMITATIONS:

- ▶ Permanent and temporary vegetation may not be appropriate in dry periods without irrigation.
- ▶ Fertilizer requirements may have potential to create stormwater pollution.

MAINTENANCE:

- ▶ Shrubs and trees must be adequately watered and fertilized and if needed pruned.
- ▶ Grasses may need to be watered and mowed.

OBJECTIVES

- Housekeeping Practices
- Contain Waste
- Minimize Disturbed Areas
- Stabilize Disturbed Areas
- Protect Slopes/Channels
- Control Site Perimeter
- Control Internal Erosion



WEBER COUNTY

ENGINEERING DEPARTMENT

2380 Washington Blvd., Suite 240
Ogden, UT 84401
(801) 399-8374

TARGETED POLLUTANTS

- Sediment
- Nutrients
- Toxic Materials
- Oil & Grease
- Floatable Materials
- Other Waste

- High Impact
- Medium Impact
- Low or Unknown Impact

IMPLEMENTATION REQUIREMENTS

- Capital Costs
- O&M Costs
- Maintenance
- Training

- High
- Medium
- Low

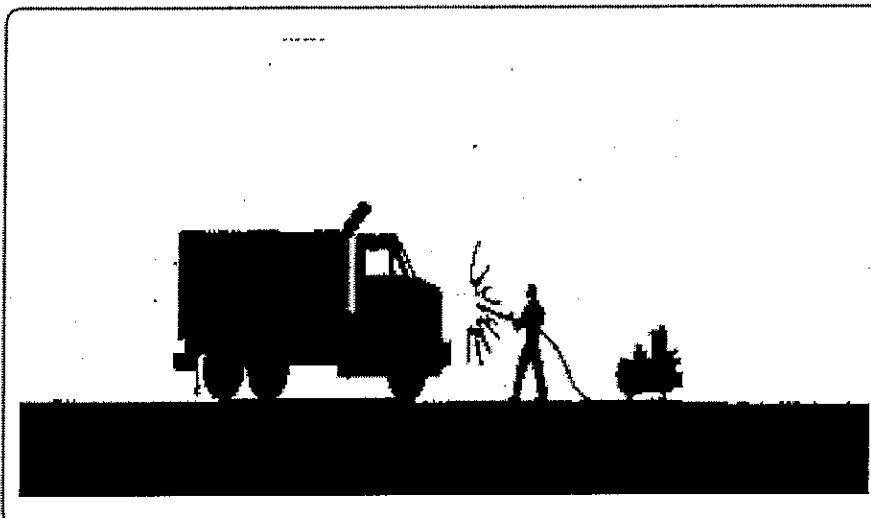

OBJECTIVES

- Manufacturing
- Material Handling
- Vehicle Maintenance
- Construction
- Commercial Activities
- Roadways
- Waste Containment
- Housekeeping Practices



WEBER COUNTY

ENGINEERING DEPARTMENT

2380 Washington Blvd., Suite 240
 Ogden, UT 84401
 (801) 399-8374

DESCRIPTION:

Prevent or reduce the discharge of pollutants to stormwater from vehicle and equipment washing and steam cleaning by using off-site facilities, washing in designated, contained areas only, eliminating discharges to the storm drain by infiltrating or recycling the wash water, and training employees and subcontractors.

APPROACH:

- ▶ Use off-site commercial washing and steam cleaning businesses as much as possible. Washing vehicles and equipment outdoors or in areas where wash water flows onto paved surfaces or into drainage pathways can pollute stormwater. If you wash a large number of vehicles or pieces of equipment, consider conducting this work at an off-site commercial business. These businesses are better equipped to handle and dispose of the wash waters properly. Performing this work off-site can also be economical by eliminating the need for a separate washing operation at your site.
- ▶ If washing must occur on-site, use designated, bermed wash areas to prevent wash water contact with stormwater, creeks, rivers, and other water bodies. The wash area can be sloped for wash water collection and subsequent infiltration into the ground.
- ▶ Use as little water as possible to avoid having to install erosion and sediment controls for the wash area. Use phosphate-free biodegradable soaps. Educate employees and subcontractors on pollution prevention measures. Do not permit steam cleaning on-site. Steam cleaning can generate significant pollutant concentrations.

LIMITATIONS:

- ▶ Even phosphate-free, biodegradable soaps have been shown to be toxic to fish before the soap degrades.
- ▶ Sending vehicles/equipment off-site should be done in conjunction with Stabilized Construction Entrance. (See BMP in the Construction Section).
- ▶ The measures outlined in this fact sheet are insufficient to address all the environmental impacts and compliance issues related to steam cleaning.

MAINTENANCE:

- ▶ Minimal, some berm repair may be necessary.

TARGETED POLLUTANTS

- Sediment
- Nutrients
- Heavy Metals
- Toxic Materials
- Oxygen Demanding Substance
- Oil & Grease
- Floatable Materials
- Bacteria & Viruses
- High Impact
- Medium Impact
- Low or Unknown Impact

IMPLEMENTATION REQUIREMENTS

- Capital Costs
- O&M Costs
- Maintenance
- Training
- High
- Medium
- Low

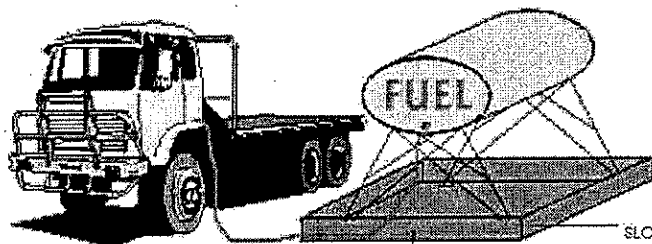

MUST BE CAPABLE OF HOLDING
100% OF TANK CAPACITY

SLOPED OR OTHERWISE
DESIGNED FOR EASY
REMOVAL OF LEAKED FUEL

OBJECTIVES

- Manufacturing
- Material Handling
- Vehicle Maintenance
- Construction
- Commercial Activities
- Roadways
- Waste Containment
- Housekeeping Practices



WEBER COUNTY

ENGINEERING DEPARTMENT

2380 Washington Blvd., Suite 240
Ogden, UT 84401
(801) 399-8374

DESCRIPTION:

Prevent fuel spills and leaks, and reduce their impacts to stormwater by using off-site facilities, fueling in designated areas only, enclosing or covering stored fuel, implementing spill controls, and training employees and subcontractors.

APPROACH:

- ▶ Use off-site fueling stations as much as possible. Fueling vehicles and equipment outdoors or in areas where fuel may spill/leak onto paved surfaces or into drainage pathways can pollute stormwater. If you fuel a large number of vehicles or pieces of equipment, consider using an off-site fueling station. These businesses are better equipped to handle fuel and spills properly. Performing this work off-site can also be economical by eliminating the need for a separate fueling area at your site.
- ▶ If fueling must occur on-site, use designated areas, located away from drainage courses, to prevent the runoff of stormwater and the runoff of spills.
- ▶ Discourage "topping-off" of fuel tanks.
- ▶ Always use secondary containment, such as a drain pan or drop cloth, when fueling to catch spills/leaks. Place a stockpile of spill cleanup materials where it will be readily accessible. Use adsorbent materials on small spills rather than hosing down or burying the spill. Remove the adsorbent materials promptly and dispose of properly.
- ▶ Carry out all federal and state requirements regarding stationary above ground storage tanks. Avoid mobile fueling of mobile construction equipment around the site; rather, transport the equipment to designated fueling areas. With the exception of tracked equipment such as bulldozers and perhaps forklifts, most vehicles should be able to travel to a designated area with little lost time. Train employees and subcontractors in proper fueling and cleanup procedures.

LIMITATIONS:

- ▶ Sending vehicles/equipment off-site should be done in conjunction with Stabilized Construction Entrance (See BMP sheet in Construction section).

MAINTENANCE:

- ▶ Keep ample supplies of spill cleanup materials on-site.
- ▶ Inspect fueling areas and storage tanks on a regular schedule.

TARGETED POLLUTANTS

- Sediment
- Nutrients
- Heavy Metals
- Toxic Materials
- Oxygen Demanding Substance
- Oil & Grease
- Floatable Materials
- Bacteria & Viruses
- High Impact
- Medium Impact
- Low or Unknown Impact

IMPLEMENTATION REQUIREMENTS

- Capital Costs
- O&M Costs
- Maintenance
- Training
- High
- Medium
- Low

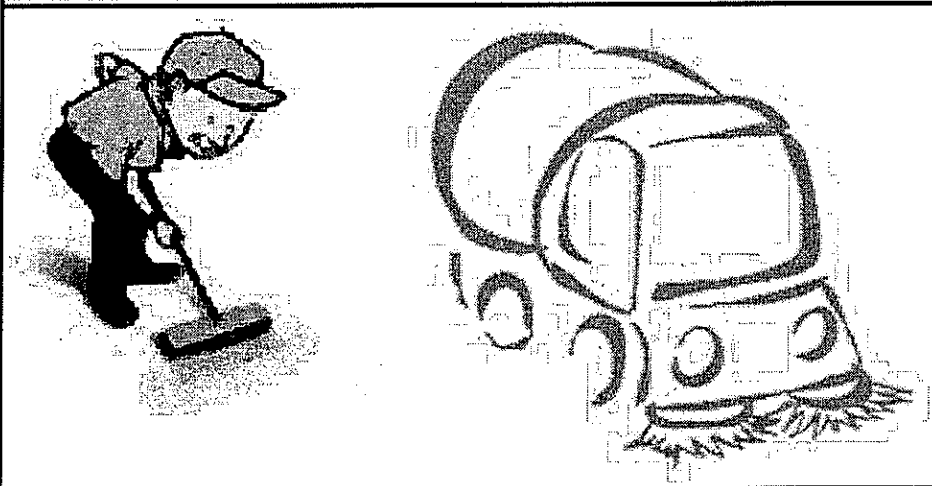

OBJECTIVES

- Housekeeping Practices
- Contain Waste
- Minimize Disturbed Areas
- Stabilize Disturbed Areas
- Protect Slopes/Channels
- Control Site Perimeter
- Control Internal Erosion

TARGETED POLLUTANTS

H M L

- Sediment
- Nutrients
- Heavy Metals
- Toxic Materials
- Oil & Grease
- Floatable Materials
- Bacteria & Viruses
- Other Waste

IMPLEMENTATION REQUIREMENTS

H M L

- Capital Costs
- O&M Costs
- Maintenance
- Training
- Staffing
- Administrative

H = High M = Medium L = Low

DESCRIPTION:

Prevent sediment from entering storm water by sweeping the streets near construction activities.

APPLICATION:

- Useful for any paved streets near construction sites where sediment is blown, tracked, or spilled onto the streets.

INSTALLATION / APPLICATION CRITERIA:

- The equipment used should be appropriate for the conditions. Vacuum sweepers work more effectively when the area is dry. Brush sweepers work better when the sediment is wet or stuck to the surface.
- Mechanical equipment should be operated and maintained according to the manufacturer's recommendations

LIMITATIONS:

- Is labor and equipment intensive
- May cause dust

MAINTENANCE:

- The street should be checked daily for any sediment deposits. Street sweeping should be implemented whenever sediment from construction activity is found on the streets

APPENDIX C

APPENDIX D

Corrective Action Log

Project Name:
SWPPP Contact:

Inspection Date	Inspector Name(s)	Description of BMP Deficiency	Corrective Action Needed (including planned date/responsible person)	Date Action Taken/Responsible person

SWPPP Amendment Log

Project Name:
SWPPP Contact:

Amendment No.	Description of the Amendment	Date of Amendment	Amendment Prepared by [Name(s) and Title]

Subcontractor Certifications/Agreements

SUBCONTRACTOR CERTIFICATION STORMWATER POLLUTION PREVENTION PLAN

Project Number: _____

Project Title: _____

Operator(s): _____

As a subcontractor, you are required to comply with the Stormwater Pollution Prevention Plan (SWPPP) for any work that you perform on-site. Any person or group who violates any condition of the SWPPP may be subject to substantial penalties or loss of contract. You are encouraged to advise each of your employees working on this project of the requirements of the SWPPP. A copy of the SWPPP is available for your review at the office trailer.

Each subcontractor engaged in activities at the construction site that could impact stormwater must be identified and sign the following certification statement:

I certify under the penalty of law that I have read and understand the terms and conditions of the SWPPP for the above designated project and agree to follow the BMPs and practices described in the SWPPP.

This certification is hereby signed in reference to the above named project:

Company: _____

Address: _____

Telephone Number: _____

Type of construction service to be provided: _____

Signature: _____

Title: _____

Date: _____

Grading and Stabilization Activities Log

Project Name:
SWPPP Contact:

Date Grading Activity Initiated	Description of Grading Activity	Date Grading Activity Ceased (Indicate Temporary or Permanent)	Date When Stabilization Measures are Initiated	Description of Stabilization Measure and Location

SWPPP Training Log

Stormwater Pollution Prevention Training Log

Project Name: _____

Project Location: _____

Instructor's Name(s): _____

Instructor's Title(s): _____

Course Location: _____ Date: _____

Course Length (hours): _____

Stormwater Training Topic: *(check as appropriate)*

- Erosion Control BMPs Emergency Procedures
 Sediment Control BMPs Good Housekeeping BMPs
 Non-Stormwater BMPs

Specific Training Objective: _____

Attendee Roster: *(attach additional pages as necessary)*

No.	Name of Attendee	Company
1		
2		
3		
4		
5		
6		
7		
8		
9		
10		

Delegation of Authority Form

Delegation of Authority

I, _____ (name), hereby designate the person or specifically described position below to be a duly authorized representative for the purpose of overseeing compliance with environmental requirements, including the Construction General Permit, at the _____ construction site. The designee is authorized to sign any reports, stormwater pollution prevention plans and all other documents required by the permit.

_____ (name of person or position)
_____ (company)
_____ (address)
_____ (city, state, zip)
_____ (phone)

By signing this authorization, I confirm that I meet the requirements to make such a designation as set forth in _____ (Reference State Permit), and that the designee above meets the definition of a “duly authorized representative” as set forth in _____ (Reference State Permit).

I certify under penalty of law that this document and all attachments were prepared under my direction or supervision in accordance with a system designed to assure that qualified personnel properly gathered and evaluated the information submitted. Based on my inquiry of the person or persons who manage the system, or those persons directly responsible for gathering the information, the information submitted is, to the best of my knowledge and belief, true, accurate, and complete. I am aware that there are significant penalties for submitting false information, including the possibility of fine and imprisonment for knowing violations.

Name: _____

Company: _____

Title: _____

Signature: _____

Date: _____

APPENDIX E

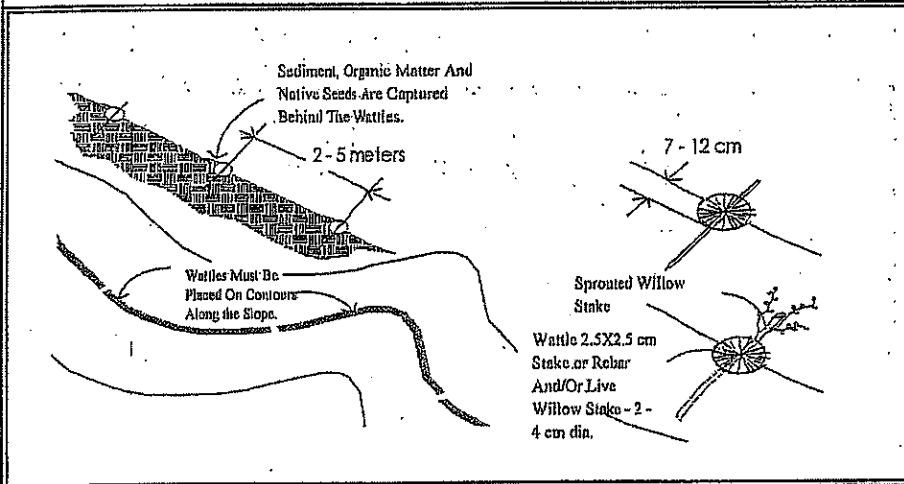

OBJECTIVES

- Housekeeping Practices
- Contain Waste
- Minimize Disturbed Areas
- Stabilize Disturbed Areas
- Protect Slopes/Channels
- Control Site Perimeter
- Control Internal Erosion

GENERAL DESCRIPTION:

Bioengineering methods combine vegetative and mechanical techniques to stabilize eroding slopes. Bioengineering methods include sprigging, tubeling, and wattling. Sprigging involves planting rhizomes, stolons, shoots, or sprouts of a desirable species. Tubelings are forbs, shrubs, or trees commercially available in reusable plastic tubes or sleeves. Wattles are bundles of cuttings from live willows, alders, or similar plants placed and secured in trenches across a slope to aid in slope stabilization.

APPLICATIONS:

- Sprigging may be performed on cut and fill slopes or other areas needing permanent soil stability.
- Tubelings may be placed on any area needing revegetation, but are most useful on slopes or flat areas where poor topsoil conditions inhibit successful seed germination and early plant growth.
- Wattlings act to reduce slope length and aid in stabilizing slopes due to surface runoff, frost heaving, needle ice, or other soil movement.

INSTALLATION/APPLICATION CRITERIA:

- Sprigging involves tearing sod apart, planting rhizomes or stolons, or transplanting shoots or sprouts. Sprigs are placed by broadcast, punching-in or with a special sprig planter.
- Tubelings involve drilling holes to the depth necessary to accommodate roots.
- Wattles are best applied to slopes no steeper than 2:1.

LIMITATIONS:

- Availability of plant materials may affect what species can be used.
- May be necessary to arrange for commercially grown tubelings.
- Cannot be used as a substitute for retaining walls or similar devices to stabilize oversteepened slopes.

MAINTENANCE:

- Sprigging and tubeling plantings should be checked periodically until they are permanently established.
- Assess the need for replacement plantings or supplemental fertilizer.
- The wattlings should be inspected at regular intervals to make sure bundles are still secure and check for sprouting of the wattling material.

TARGETED POLLUTANTS

- Sediment
- Nutrients
- Toxic Materials
- Oil & Grease
- Floatable Materials
- Other Waste

- High Impact
- Medium Impact
- Low or Unknown Impact

IMPLEMENTATION REQUIREMENTS

- Capital Costs
- O&M Costs
- Maintenance
- Training

- High Medium Low

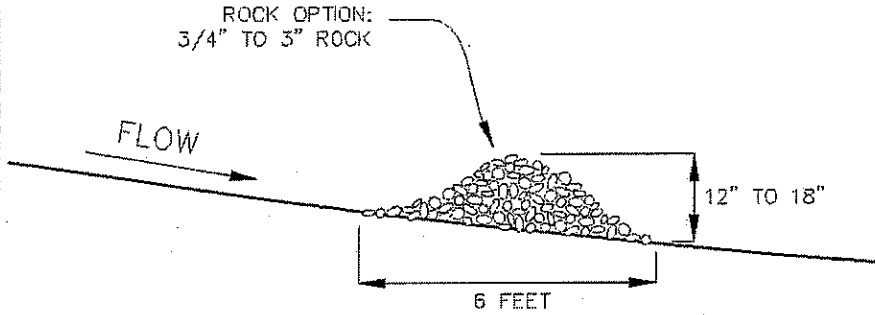

OBJECTIVES

- Housekeeping Practices
- Contain Waste
- Minimize Disturbed Areas
- Stabilize Disturbed Areas
- Protect Slopes/Channels
- Control Site Perimeter
- Control Internal Erosion

TARGETED POLLUTANTS

H M L

- Sediment
- Nutrients
- Heavy Metals
- Toxic Materials
- Oil & Grease
- Floatable Materials
- Bacteria & Viruses
- Other Waste

DESCRIPTION:

A rock filter is made of rock 3/4" - 3" in diameter and placed along a level contour. A brush filter is composed of brush (usually obtained during the site clearing) wrapped in filter cloth and anchored to the toe of the slope. If properly anchored brush or rock filters may be used for sediment trapping and velocity reduction.

APPLICATION:

- As check dams across mildly sloped construction roads
- Below the toe of slopes
- Along the site perimeter
- In areas where sheet flow occurs
- Around temporary spoil areas
- At sediment traps or culvert/pipe outlets

INSTALLATION / APPLICATION CRITERIA:

- For rock filter, use larger rock and place in a staked, woven wire sheathing if placed where concentrated flows occur
- Install along a level contour
- Leave area behind berm where runoff can pond and sediment can settle
- Drainage areas should not exceed 5 acres

LIMITATIONS:

- Rock berms may be difficult to remove
- Removal problems limit their usefulness in landscaped areas
- Runoff will pond upstream of the filter, possibly causing flooding if sufficient space does not exist

MAINTENANCE:

- Inspect after each rainfall and at a minimum of once every two weeks
- If berm is damaged, reshape and replace lost/dislodged rock
- Remove sediment when depth reaches 1/3 of berm height or 1 ft

IMPLEMENTATION REQUIREMENTS

H M L

- Capital Costs
- O&M Costs
- Maintenance
- Training
- Staffing
- Administrative

H = High M = Medium L = Low

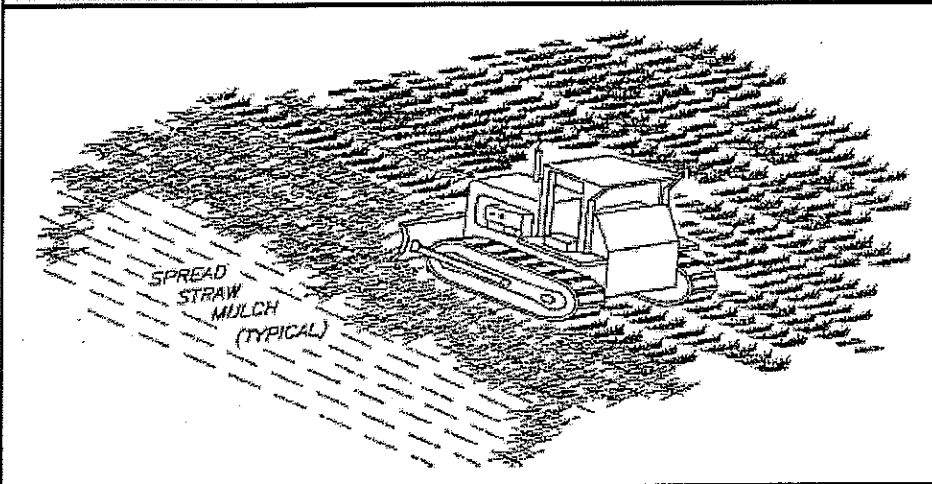

DESCRIPTION:

Applying materials such as vinyl, asphalt, plastics, or rubber on an unprotected slope to temporarily stabilize the slope.

APPLICATION:

- As a tacking agent to aid the stabilization of mulches (where matting is not used)
- As a short-term alternative in areas where temporary seeding practices cannot be used because of seasonal condition or climate
- On steep and rocky slopes where neither mechanical methods or mulches and protective netting can be effectively applied

INSTALLATION / APPLICATION CRITERIA:

- The application rates and procedures recommended by the manufacturer of a chemical stabilization product should be followed to prevent the products from forming ponds and from creating large areas where moisture cannot get through.
- For permanent application, chemical mulches (when used with seed and mulch) should be applied over wood fiber or straw mulch

LIMITATIONS:

- Chemical mulches can create impervious surfaces and impact water quality if not properly applied
- Some products may not be suitable for use near live streams

MAINTENANCE:

- Inspect at regular intervals and after each runoff-producing storm event or at a minimum of once every two weeks
- Replace chemical mulch as needed to ensure adequate level of coverage

OBJECTIVES

- Housekeeping Practices
- Contain Waste
- Minimize Disturbed Areas
- Stabilize Disturbed Areas
- Protect Slopes/Channels
- Control Site Perimeter
- Control Internal Erosion

TARGETED POLLUTANTS

H M L

- Sediment
- Nutrients
- Heavy Metals
- Toxic Materials
- Oil & Grease
- Floatable Materials
- Bacteria & Viruses
- Other Waste

IMPLEMENTATION REQUIREMENTS

H M L

- Capital Costs
- O&M Costs
- Maintenance
- Training
- Staffing
- Administrative

H = High M = Medium L = Low

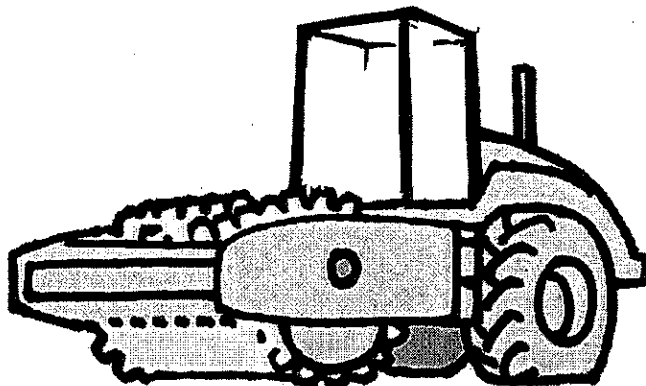

OBJECTIVES

- Housekeeping Practices
- Contain Waste
- Minimize Disturbed Areas
- Stabilize Disturbed Areas
- Protect Slopes/Channels
- Control Site Perimeter
- Control Internal Erosion

TARGETED POLLUTANTS

H M L

- Sediment
- Nutrients
- Heavy Metals
- Toxic Materials
- Oil & Grease
- Floatable Materials
- Bacteria & Viruses
- Other Waste

IMPLEMENTATION REQUIREMENTS

H M L

- Capital Costs
- O&M Costs
- Maintenance
- Training
- Staffing
- Administrative

H = High M = Medium L = Low

DESCRIPTION:

Use of rolling, tamping, or vibration to stabilize fill materials and control erosion by increasing the soil density. Increasing the density of soil improves soil strength, reduces long-term soil settlement, and provides resistance to erosion.

APPLICATIONS:

- Stabilize fill material placed around various structures.
- Improve soil in place as foundation support for roads, parking lots, and buildings.

INSTALLATION / APPLICATION CRITERIA:

- Make sure soil moisture content is at optimum levels.
- Use proper compaction equipment.
- Install sediment control and storm water management devices below compacted areas and runoff interceptor devices above these areas. Drainage from compacted areas must be carefully planned to protect adjacent uncompacted soils.
- The surface of compacted areas should be scarified and seeded or mulched and seeded to increase the effectiveness of compaction.

LIMITATIONS:

- Compaction tends to increase runoff.
- Over-compaction will hamper revegetation efforts.

MAINTENANCE:

No maintenance required.

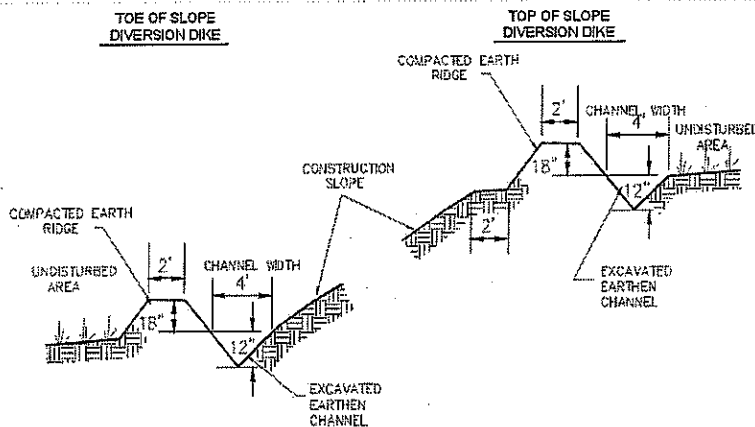

DESCRIPTION:

A temporary sediment barrier and storm runoff conveyance consisting of an excavation channel and compacted earth ridge.

APPLICATION:

- Construct along top of construction slope to intercept upgradient runoff and convey around construction site
- Construct along toe of construction to divert sediment laden runoff
- Construct along midpoint of construction slope to intercept runoff and channel to controlled discharge point
- Construct around base of soil stockpiles to capture sediment
- Construct around perimeter of disturbed areas to capture sediment

INSTALLATION / APPLICATION CRITERIA:

- Clear and grub area for dike construction
- Excavate channel and place soil on downgradient side
- Shape and machine compact excavated soil to form ridge
- Place erosion protection (riprap, mulch) at outlet
- Stabilize channel and ridge as required with mulch, gravel, or vegetative cover

LIMITATIONS:

- Recommended maximum drainage area of 5 acres
- Recommended maximum sideslopes of 2h:1v (50%)
- Recommended maximum slope of 1% on channel

MAINTENANCE:

- Inspect immediately after any rainfall and at least daily during prolonged rainfall
- Look for runoff breaching dike or eroding channel or sideslopes
- Check discharge point for erosion or bypassing of flows
- Repair and stabilize as necessary
- Inspect daily during vehicular activity on slope, check for and repair any traffic damage

OBJECTIVES

- Housekeeping Practices
- Contain Waste
- Minimize Disturbed Areas
- Stabilize Disturbed Areas
- Protect Slopes/Channels
- Control Site Perimeter
- Control Internal Erosion

TARGETED POLLUTANTS

H M L

- Sediment
- Nutrients
- Heavy Metals
- Toxic Materials
- Oil & Grease
- Floatable Materials
- Bacteria & Viruses
- Other Waste

IMPLEMENTATION REQUIREMENTS

H M L

- Capital Costs
- O&M Costs
- Maintenance
- Training
- Staffing
- Administrative

H = High M = Medium L = Low

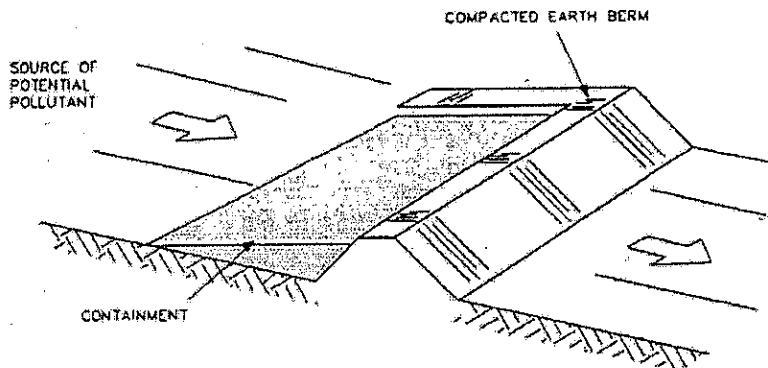

OBJECTIVES

- Housekeeping Practices
- Contain Waste
- Minimize Disturbed Areas
- Stabilize Disturbed Areas
- Protect Slopes/Channels
- Control Site Perimeter
- Control Internal Erosion

TARGETED POLLUTANTS

H M L

- Sediment
- Nutrients
- Heavy Metals
- Toxic Materials
- Oil & Grease
- Floatable Materials
- Bacteria & Viruses
- Other Waste

IMPLEMENTATION REQUIREMENTS

H M L

- Capital Costs
- O&M Costs
- Maintenance
- Training
- Staffing
- Administrative

H = High M = Medium L = Low

DESCRIPTION:

A temporary containment control constructed of compacted soil.

APPLICATION:

- Construct around waste and materials storage area
- Construct around staging and maintenance areas
- Construct around vehicle parking and servicing areas

INSTALLATION / APPLICATION CRITERIA:

- Construct an earthen berm down hill of the area to be controlled. The berm should surround fueling facilities and maintenance areas on three sides to provide containment
- Berm needs to sized for application and be compacted by compactor equipment

LIMITATIONS:

- Not effective on steep slopes
- Limits access to controlled area
- Personnel need to quickly respond to spills with remedial actions

MAINTENANCE:

- Observe daily for any non-stormwater discharge
- Look for runoff bypassing ends of berms or undercutting berms
- Repair or replace damaged areas of the berm and remove accumulated sediment
- Recompact soil around berm as necessary to prevent piping

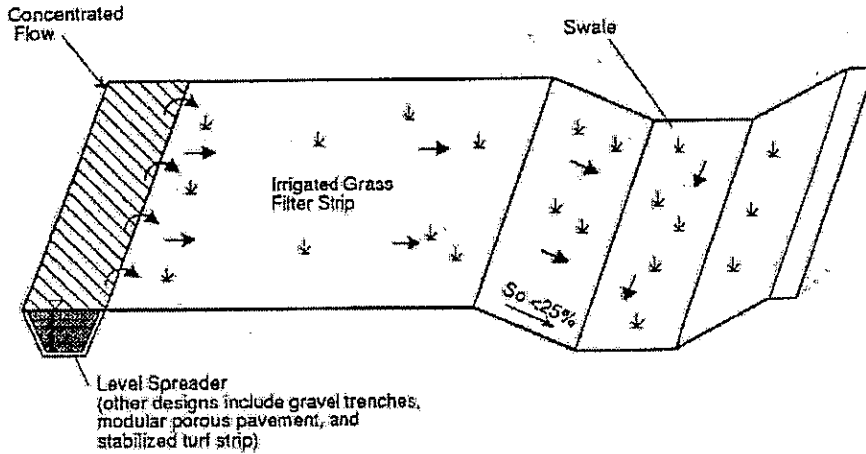

OBJECTIVES

- Housekeeping Practices
- Contain Waste
- Minimize Disturbed Areas
- Stabilize Disturbed Areas
- Protect Slopes/Channels
- Control Site Perimeter
- Control Internal Erosion

TARGETED POLLUTANTS

H M L

- Sediment
- Nutrients
- Heavy Metals
- Toxic Materials
- Oil & Grease
- Floatable Materials
- Bacteria & Viruses
- Other Waste

IMPLEMENTATION REQUIREMENTS

H M L

- Capital Costs
- O&M Costs
- Maintenance
- Training
- Staffing
- Administrative

H = High M = Medium L = Low

DESCRIPTION:

Filter strips are 20-foot-wide strips of natural or planted vegetation around a construction site. They are designed to cause deposition of sediments within the vegetation layer.

APPLICATION:

- Suited for areas where the soils are well drained or moderately well drained
- Areas where the bedrock and the water table are well below the surface

INSTALLATION / APPLICATION CRITERIA:

- Make sure the vegetative cover is dense enough to protect underlying soil while causing sediment to settle
- Filter strip must be approximately 20 feet wide to function well
- The length should be approximately 50 to 75 feet. Where slopes become steeper the length of the strip must be increased.

LIMITATIONS:

- Only applicable in areas where vegetation is previously established or where sod is added
- Vegetated filter strips will not function well on steep slopes, in hilly areas, or in highly paved areas
- Sites with slopes of 15 percent or more may not be suitable for filtering storm water flows

MAINTENANCE:

- Check for channels and repair
- Provide rock aprons to aid in slowing flow if necessary
- Maintain vegetation at optimal height and thickness

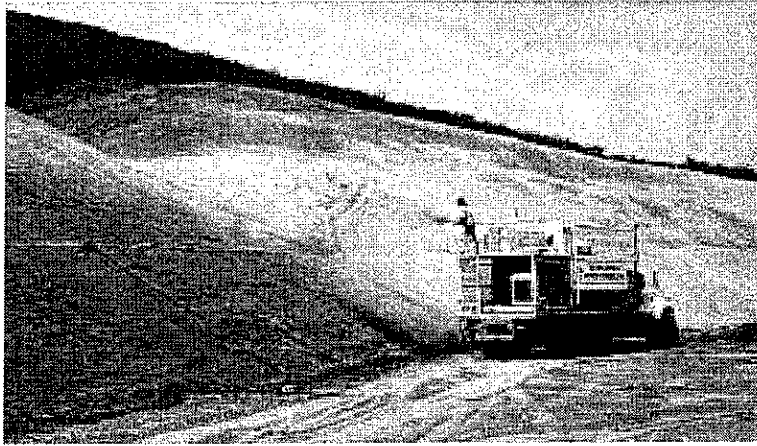

DESCRIPTION:

A combination of wood fiber mulch, processed grass, or hay or straw mulch and a tacking agent. It is made into a slurry, then applied to bare slopes or other bare areas to provide temporary stabilization.

APPLICATION:

- Small roadside slopes
- Large, relatively flat areas

INSTALLATION / APPLICATION CRITERIA:

- Legume seeds should be pellet inoculated with the appropriate bacteria.
- The seed should not remain in the hydromulcher tank for more than 30 minutes
- Wood fiber may be dyed to aid in uniform application
- Slurry should be uniformly applied until an adequate coverage is achieved
- The applicator should not be directed at on location for a long period of time; erosion will occur

LIMITATIONS:

- Will lose effectiveness after 1 year
- Can use only on physically stable slopes (at natural angle of repose, or less)

MAINTENANCE:

- Periodically inspect for damage caused by wind, water or human disturbance
- Promptly repair damaged areas

OBJECTIVES

- Housekeeping Practices
- Contain Waste
- Minimize Disturbed Areas
- Stabilize Disturbed Areas
- Protect Slopes/Channels
- Control Site Perimeter
- Control Internal Erosion

TARGETED POLLUTANTS

H M L

- Sediment
- Nutrients
- Heavy Metals
- Toxic Materials
- Oil & Grease
- Floatable Materials
- Bacteria & Viruses
- Other Waste

IMPLEMENTATION REQUIREMENTS

H M L

- Capital Costs
- O&M Costs
- Maintenance
- Training
- Staffing
- Administrative

H = High M = Medium L = Low

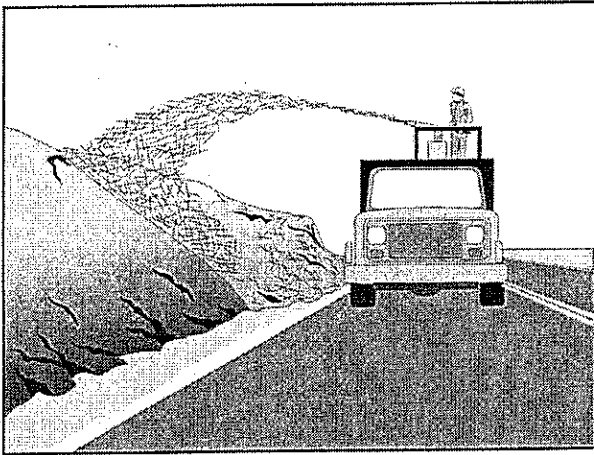

DESCRIPTION:

Placement of material such as straw, grass, woodchips, or wood fibers over open areas.

APPLICATION:

- Any exposed area to remain untouched longer than 14 days and that will be exposed less than 60 days (seed areas to be exposed in excess of 60 days)
- Areas that have been seeded
- Stockpiled soil materials

INSTALLATION / APPLICATION CRITERIA:

- Roughen area to receive mulch to create depressions that mulch material can settle into
- Apply mulch to required thickness and anchor as necessary
- Ensure material used is weed free and does not contain any constituents that will inhibit plant growth

LIMITATIONS:

- Anchoring may be required to prevent migration of mulch material
- Downgradient control may be required to prevent mulch material being transported to storm water system

MAINTENANCE:

- Inspect mulched areas after every rainfall event and at a minimum of monthly
- Replace mulch on any bare areas and reanchor as necessary
- Clean and replace downgradient controls as necessary

OBJECTIVES

- Housekeeping Practices
- Contain Waste
- Minimize Disturbed Areas
- Stabilize Disturbed Areas
- Protect Slopes/Channels
- Control Site Perimeter
- Control Internal Erosion

TARGETED POLLUTANTS

H M L

- Sediment
- Nutrients
- Heavy Metals
- Toxic Materials
- Oil & Grease
- Floatable Materials
- Bacteria & Viruses
- Other Waste

IMPLEMENTATION REQUIREMENTS

H M L

- Capital Costs
- O&M Costs
- Maintenance
- Training
- Staffing
- Administrative

H = High M = Medium L = Low

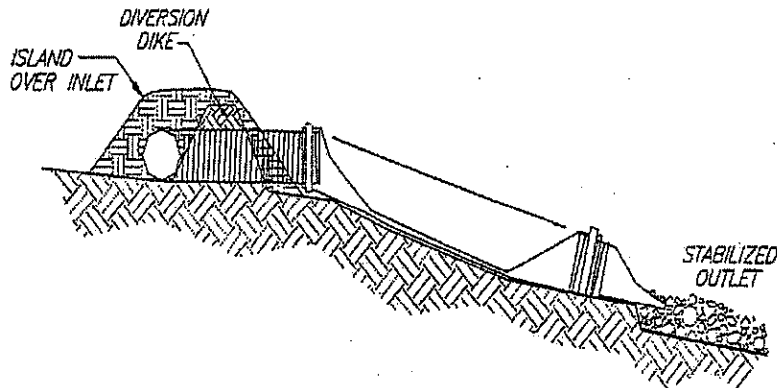

DESCRIPTION:

A temporary pipe or lined channel that drains the top of a slope to a stable discharge point at the bottom of a slope without causing erosion.

APPLICATION:

- Where concentrated flow of surface runoff must be conveyed down a slope in order to prevent erosion
- Emergency spillway for a sediment basin

INSTALLATION / APPLICATION CRITERIA:

- Secure inlet and surround with dikes to prevent gully erosion, and anchor pipe to slope
- Size to convey at least the peak of a 10-year storm event
- Stabilize outlet (See Outlet Protection BMP.)

LIMITATIONS:

- Maximum drainage area per slope drain is 5 acres
- Clogged slope drains will force water around the pipe and cause slope erosion
- Dissipation of high flow velocities at the pipe outlet is required to avoid downstream erosion
- Failure can result in flooding and severe erosion

MAINTENANCE:

- Structure must be inspected weekly and after storms
- Inlet must be protected from undercutting and no water should circumvent the entry
- Outlet should not produce erosion; velocity dissipators must be maintained
- Pipe anchors must be checked to ensure that the pipe remains anchored to the slope

OBJECTIVES

- Housekeeping Practices
- Contain Waste
- Minimize Disturbed Areas
- Stabilize Disturbed Areas
- Protect Slopes/Channels
- Control Site Perimeter
- Control Internal Erosion

TARGETED POLLUTANTS

H M L

- Sediment
- Nutrients
- Heavy Metals
- Toxic Materials
- Oil & Grease
- Floatable Materials
- Bacteria & Viruses
- Other Waste

IMPLEMENTATION REQUIREMENTS

H M L

- Capital Costs
- O&M Costs
- Maintenance
- Training
- Staffing
- Administrative

H = High M = Medium L = Low

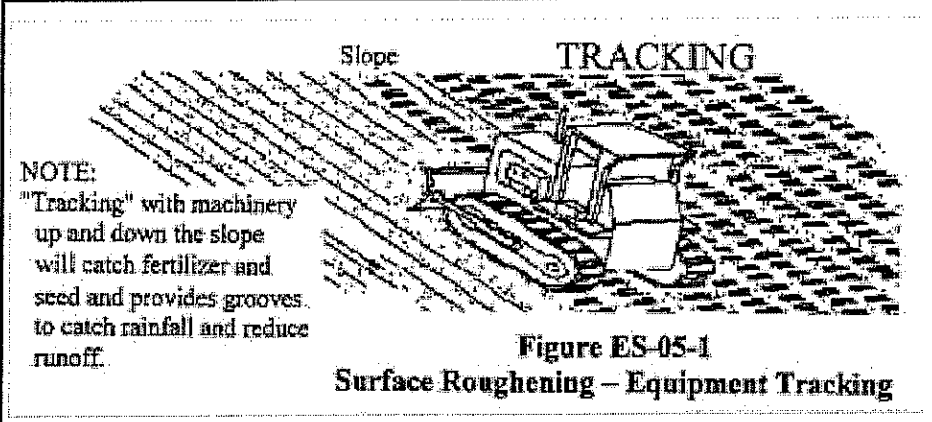

DESCRIPTION:

Rough preparation of working areas leaving depressions and uneven surface. Depressions should be done parallel to contours.

APPLICATION:

- Surface roughening is appropriate for all construction that will not be receiving impervious cover within 14 days and that will be exposed less than 60 days (seed areas to be open in excess of 60 days)

INSTALLATION / APPLICATION CRITERIA:

- Surface should be left in rough condition during initial earthwork activity
- Surfaces that have become smoothed or compacted due to equipment traffic should be roughened by use of disks, spring harrows, teeth on front end loader, or similar, operating along the contours of the slope. Tracking (by crawler tractor driving up and down slope) may also be used to provide depressions parallel to contours
- Avoid compaction of soils during roughening as this inhibits plant growth and promotes storm water runoff. Limit tracked machinery to sandy soil
- Seed or mulch areas to be exposed in excess of 60 days
- Employ dust controls (see Dust Control Detail Sheet if appropriate)

LIMITATIONS:

- Will not withstand heavy rainfall
- Slopes steeper than 2:1 (50%) should be benched (see Benching Detail Sheet)

MAINTENANCE:

- Inspect following any storm event and at a minimum of weekly
- If erosion in the form of rills (small waterways formed by runoff) is evident, perform machine roughening of area
- For vegetated slopes reseed areas that are bare or have been reworked

OBJECTIVES

- Housekeeping Practices
- Contain Waste
- Minimize Disturbed Areas
- Stabilize Disturbed Areas
- Protect Slopes/Channels
- Control Site Perimeter
- Control Internal Erosion

TARGETED POLLUTANTS

H M L

- Sediment
- Nutrients
- Heavy Metals
- Toxic Materials
- Oil & Grease
- Floatable Materials
- Bacteria & Viruses
- Other Waste

IMPLEMENTATION REQUIREMENTS

H M L

- Capital Costs
- O&M Costs
- Maintenance
- Training
- Staffing
- Administrative

H = High M = Medium L = Low

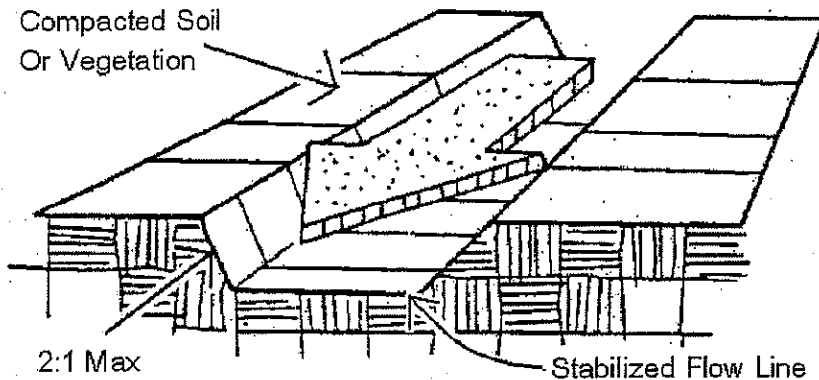

OBJECTIVES

- Housekeeping Practices
- Contain Waste
- Minimize Disturbed Areas
- Stabilize Disturbed Areas
- Protect Slopes/Channels
- Control Site Perimeter
- Control Internal Erosion

TARGETED POLLUTANTS

H M L

- Sediment
- Nutrients
- Heavy Metals
- Toxic Materials
- Oil & Grease
- Floatable Materials
- Bacteria & Viruses
- Other Waste

IMPLEMENTATION REQUIREMENTS

H M L

- Capital Costs
- O&M Costs
- Maintenance
- Training
- Staffing
- Administrative

H = High M = Medium L = Low

DESCRIPTION:

Temporary drains and swales are used to divert off-site runoff around the construction site, divert runoff from stabilized areas around disturbed areas.

APPLICATION:

- Temporary drains and swales are appropriate for diverting and upslope runoff around unstabilized or disturbed areas of the construction site
- Prevent slope failures. Prevent damage to adjacent property. Prevents erosion and transport of sediments into water ways. Increases the potential for infiltration. Diverts sediment-laden runoff into sediment basins or traps.

INSTALLATION / APPLICATION CRITERIA:

- Temporary drainage swales will effectively convey runoff and avoid erosion if built properly
- Size temporary drainage swales using local drainage design criteria. A permanent drainage channel must be designed by a professional engineer (see the local drainage design criteria for proper design)
- At a minimum, the drain/swale should conform to predevelopment drainage patterns and capacities
- Construct the drain/swale with an uninterrupted positive grade to a stabilized outlet. Provide erosion protection or energy dissipation measures if the flow out of the drain or swale can reach an erosive velocity

LIMITATIONS:

- Temporary drains and swales or any other diversion of runoff should not adversely impact upstream or downstream properties
- Temporary drains and swales must conform to local floodplain management requirements

MAINTENANCE:

- Inspect weekly and after each rain
- Repair any erosion immediately
- Remove sediment which builds up in the swale and restricts its flow capacity