

Preliminary Plan for
Summerset Farms
A Lot Averaging Subdivision
 A part of the Southeast Quarter of Section 28, T6N, R2W, SLB&M, U.S. Survey
 Weber County, Utah
 March 2019

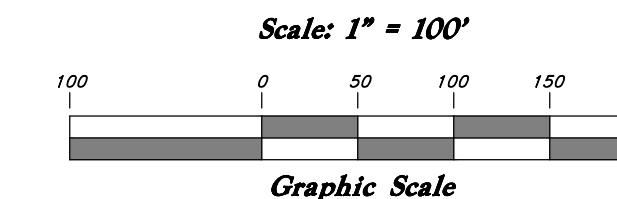

East Quarter Corner of Section 28, T6N, R2W, SLB&M, U.S. Survey (Found 3" Brass Cap Monument in the Intersection of 2200 South Street and 3500 West located approximately 6' below ground dated 1982 in fair condition. Monument has since been removed and replaced in 2018)

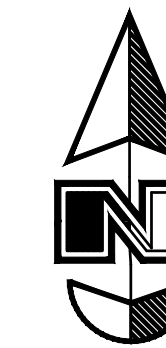

VICINITY MAP
(Not to Scale)

LEGEND

- Centerline
- UGT Buried Telephone line
- OHT Overhead Telephone line
- OHP Overhead Power line
- UGP Power line
- Sanitary Sewer line
- Culinary Water line
- G Gas line
- SD Storm Drain line
- SW Secondary Waterline
- LD Land Drain line
- IW Irrigation Waterline
- FPM Fence Power Meter
- Post
- Water Meter
- Gas Meter
- Power Meter
- Telephone Box
- Sewer Manhole
- Drain Manhole
- Water Manhole
- Cleanout Box
- TA Top of Asphalt
- EA Edge of Asphalt
- NG Natural Ground
- LG Lip of Gutter
- SP Service Pole
- LP Light Pole
- PP Power Pole
- TP Telephone Pole
- FH Fire Hydrant
- DIT Flowline of Ditch
- TOE Toe of Slope
- TOP Top of Slope
- CO Cleanout
- FC Fence
- DMH Drain Manhole
- SE Spot Elevation
- Contour
- Asphalt
- Concrete
- Building
- Catch Basin
- Corrugated Metal Pipe
- R.C.P. Reinforced Concrete Pipe
- CONC Edge of Concrete
- Retaining Wall
- SWM Sewer Manhole
- Water Valve
- CP Catch Basin
- DV Diversion Box
- TC Top of Curb
- SW Sidewalk
- GAS Gas line Marker
- GUY Guy Wire
- BLDG Building Corner
- Fire Hydrant
- Natural Ground
- Water Valve
- Light Pole
- Power Pole w/guy
- Deciduous Tree
- Coniferous Tree
- ARP Area Reference Point
- Building Columns
- Landscaping

Line	Bearing	Length
L1	S 0°36'21" W	107.25
L2	S 89°12'24" E	101.57
L3	S 89°13'14" E	280.23
L4	N 0°33'51" E	101.83
L5	S 57°32'10" W	15.18
L6	S 69°17'41" W	9.22

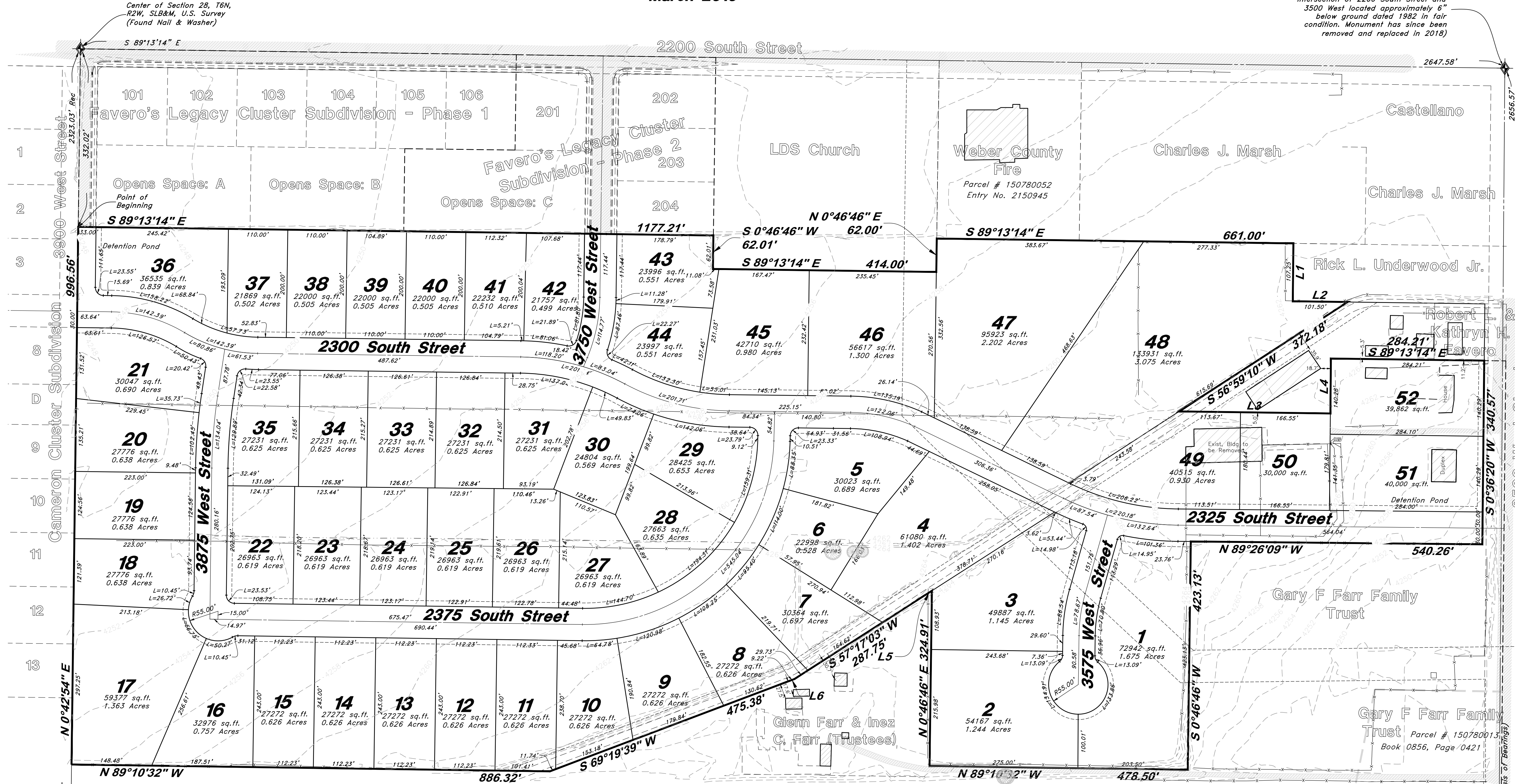

South Quarter Corner of Section 28, T6N, R2W, SLB&M, U.S. Survey (Found 3" Brass Cap Monument in 8" Concrete Column 1" below Asphalt, located in 2550 South Street, Dated 1963 in Fair Condition)

Southeast Corner of Section 28, T6N, R2W, SLB&M, U.S. Survey (Found 3" Brass Cap Monument inside a ring and lid in the Intersection of 2550 South Street and 3500 West Street dated 2004 in good condition)

PARCEL INFORMATION

This property is Zoned A-1 (Agricultural) and is proposed to be developed the lot averaging ordinance.
 Parcel Area = 2,156,216 sq.ft. or 49.500 Acres
 49.500 Acres / 1 lot/per Acre = 50 Lots

ZONING INFORMATION

This property is Zoned A-1 (Agricultural) and has the following building setbacks:
 Front Yard = 20 feet
 Side Yard = 8 feet (Dwelling)
 Other Main Building (20 feet)
 Side Facing Street on Corner Lot (20 feet)
 Back Yard = 20 feet
 Building Height = 1 Story building (35 feet maximum)

DESCRIPTION

A part of the Southeast Quarter of Section 28, Township 6 North, Range 2 West, Salt Lake Base and Meridian, U.S. Survey, Weber County, Utah:
 Beginning at a point on the Quarter Section Line, said point being 332.02 feet South 0°42'54" West from the Center of said Section 28; and running thence South 89°13'14" East 1177.21 feet to the Westerly Line of the LDS Church Property; thence along the Westerly, Southerly and Easterly Lines of said LDS Church Property the following three (3) courses: (1) South 0°46'46" West 62.01 feet, (2) South 89°13'14" East 414.00 feet and (3) North 0°46'46" East 62.00 feet to the Southwest Corner of the Weber County Fire Property; thence South 89°13'14" East 661.00 feet to the Northwest corner of the Rick L. Underwood Jr. Property; thence along the Westerly and Southerly Lines of said property the following two (2) courses: (1) South 0°36'20" West 107.25 feet and (2) South 89°12'24" East 101.57 feet thence South 56°59'10" West 372.18 feet; thence South 89°13'14" East 280.23 feet; thence North 0°33'51" East 101.83 feet; thence South 89°13'14" East 284.21 feet to the West Right-of-Way Line of 3500 West Street as widened; thence South 0°36'20" West 340.57 feet along said West right of way line to the Northerly Line of the Gary F. Farr Family Trust Property; thence along said Northerly and Westerly Lines of said Property the following two (2) courses: (1) North 89°26'09" West 540.26 feet and (2) South 0°46'46" West 423.13 feet; thence North 89°10'32" West 478.50 feet; thence North 0°46'46" East 324.91 feet; thence South 56°32'10" West 15.18 feet; thence South 57°17'03" West 287.75 feet; thence South 69°17'41" West 9.22 feet; thence South 69°19'39" West 475.38 feet; thence North 89°10'32" West 886.32 feet to said Quarter Section Line and the Easterly Line of the Cameron Cluster Subdivision (Weber County, Utah); thence North 0°42'54" East 996.56 feet along said Quarter Section line and said Easterly Line to the Point of Beginning.
 Contains 48.833 Acres, More or Less

NOTE

1. 10' wide Public Utility and Drainage Easements (P.U.&D.E.) on front lot lines as indicated by dashed lines except as otherwise shown.

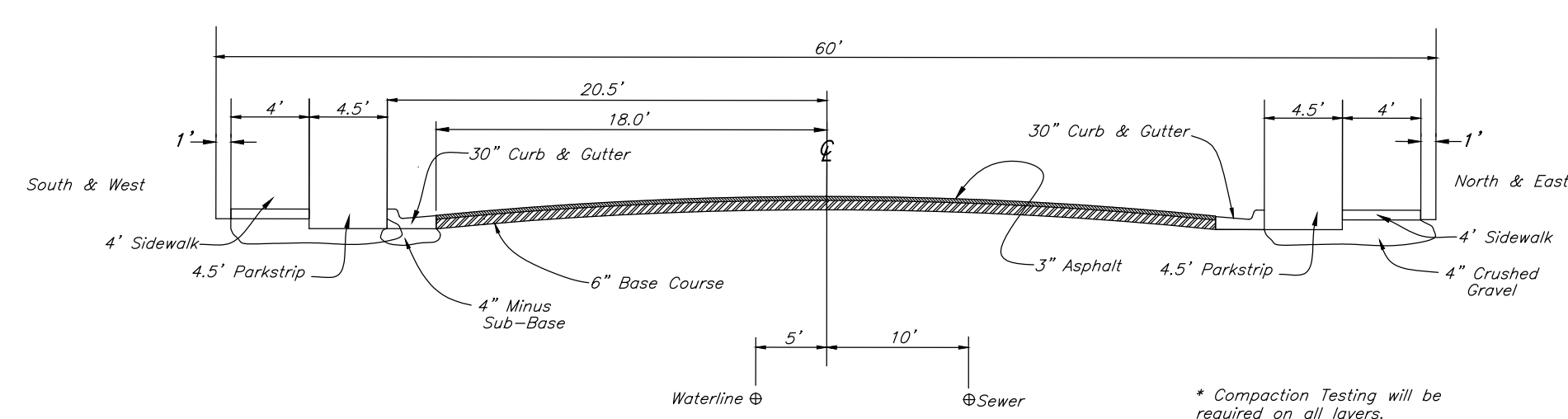

STANDARD ROADWAY SECTION
NOT TO SCALE

GREAT BASIN ENGINEERING
 5746 SOUTH 1475 EAST, OGDEN, UTAH 84403
 MAIN (801) 394-4515 FAX (801) 392-7944
 WWW.GREATBASINENGINEERING.COM

Preliminary Plan
Summerset Farms
 Weber County, Utah
 A part of Section 28, T6N, R2W, SLB&M, U.S. Survey

6 Feb, 2019
 SHEET NO. 1 of 2

PRELIMINARY PLAN

Preliminary Plan for
Summerset Farms
 A Lot Averaging Subdivision
 A part of the Southeast Quarter of Section 28, T6N, R2W, SLB&M, U.S. Survey
 Weber County, Utah
 March 2019



VICINITY MAP
 (Not to Scale)

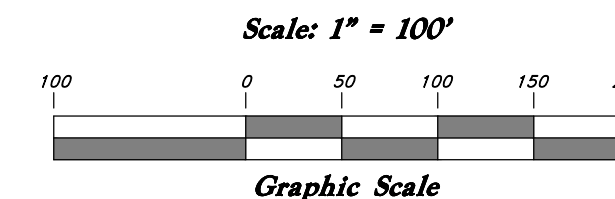
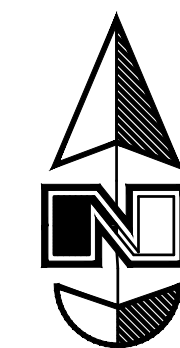

East Quarter Corner of Section 28, T6N, R2W, SLB&M, U.S. Survey (Found 3" Brass Cap Monument in the Intersection of 2200 South Street and 3500 West located approximately 8" below ground dated 1982 in fair condition. Monument has since been removed and replaced in 2018)

LEGEND

- Centerline
- UGT- Buried Telephone line
- OHF- Overhead Telephone line
- OHP- Overhead Power line
- UGP- Power line
- SS- Sanitary Sewer line
- HW- Culinary Water line
- G- Gas line
- SD- Storm Drain line
- SW- Secondary Waterline
- LD- Land Drain line
- IW- Irrigation Waterline
- FM- Fenced Power Meter
- Post
- Water Meter
- Gas Meter
- Power Meter
- Telephone Box
- Sewer Manhole
- Drain Manhole
- Water Manhole
- Cleanout Box
- TA- Top of Asphalt
- EA- Edge of Asphalt
- NG- Natural Ground
- LG- Lip of Gutter
- SP- Service Pole
- LP- Light Pole
- PP- Power Pole
- TP- Telephone Pole
- FH- Fire Hydrant
- DIT- Flowline of Ditch
- TOE- Toe of Slope
- TOP- Top of Slope
- CO- Cleanout
- FC- Fence
- DMH- Drain Manhole
- x99.00- Spot Elevation
- Contour
- Asphalt
- Concrete
- Building
- Catch Basin
- C.M.P.- Corrugated Metal Pipe
- R.C.P.- Reinforced Concrete Pipe
- CONC- Edge of Concrete
- RWALL- Retaining Wall
- SMH- Sewer Manhole
- WV- Water Valve
- CB- Catch Basin
- DV- Diversion Box
- TC- Top of Curb
- SW- Sidewalk
- GAS- Gas line Marker
- GUY- Guy Wire
- BLDG- Building Corner
- NG- Natural Ground
- LP- Light Pole
- Power Pole w/guy
- Deciduous Tree
- Coniferous Tree
- ARP- Area Reference Point
- COL- Building Columns
- LS- Landscaping

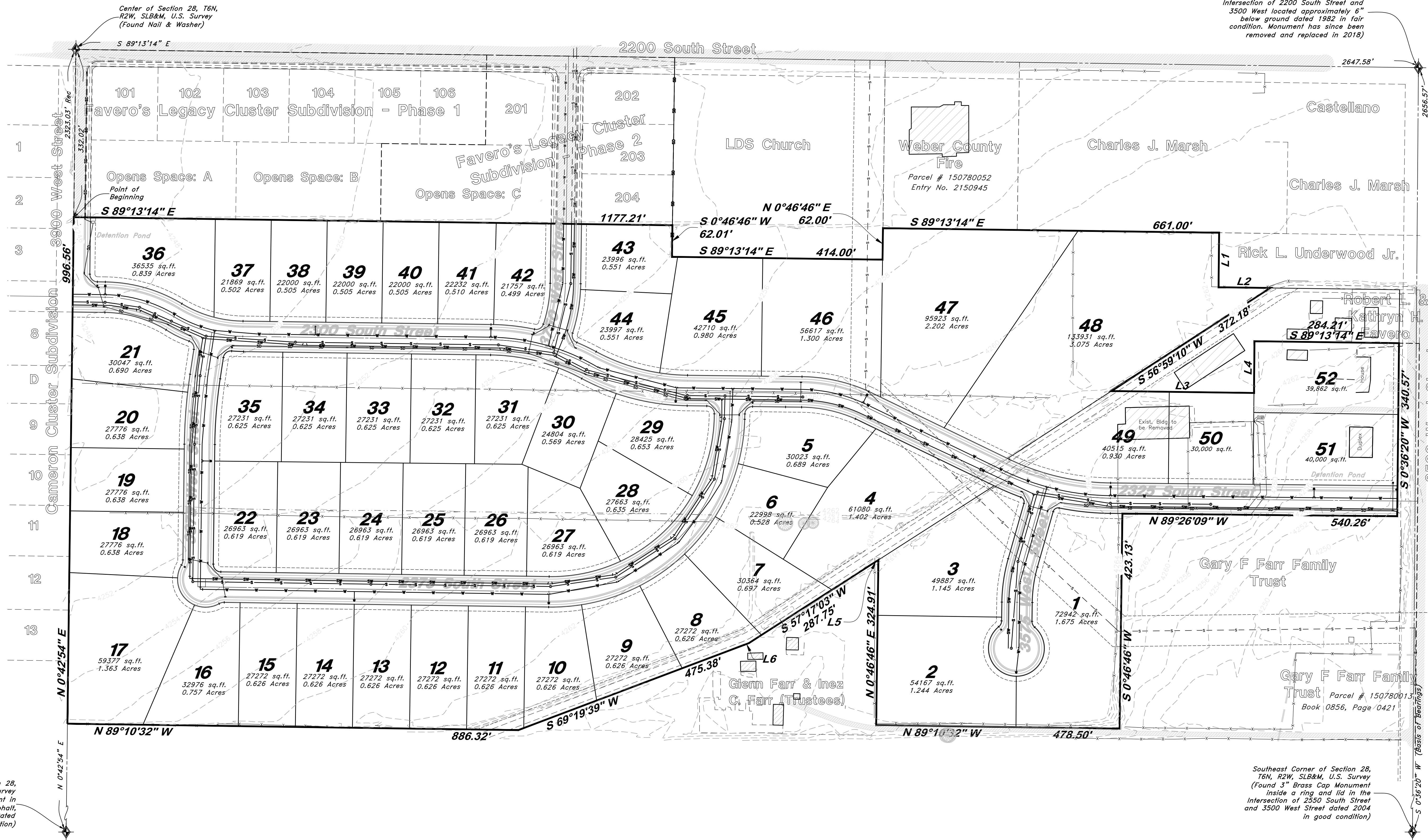

South Quarter Corner of Section 28, T6N, R2W, SLB&M, U.S. Survey (Found 3" Brass Cap Monument in 8" Concrete Column 1" below Asphalt, located in 2550 South Street, Dated 1963 in Fair Condition)

Southeast Corner of Section 28, T6N, R2W, SLB&M, U.S. Survey (Found 3" Brass Cap Monument inside a ring and lid in the Intersection of 2550 South Street and 3500 West Street dated 2004 in good condition)

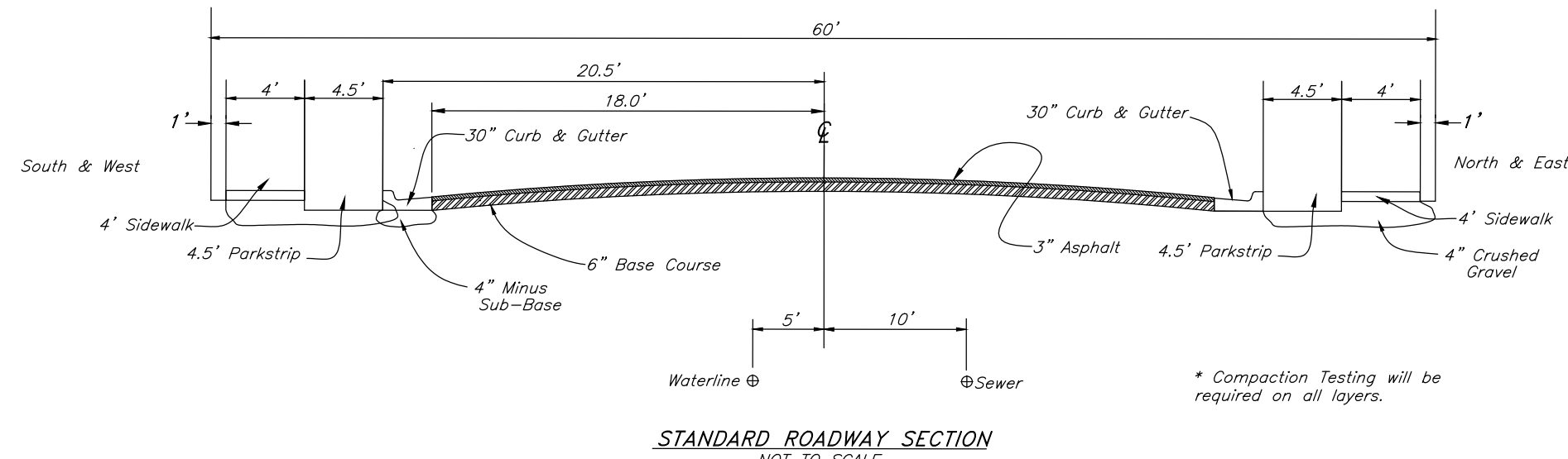

PROPOSED UTILITY NOTE

- Sanitary Sewer - 8" SDR-35
 - Secondary Water - 8" PVC
 - Water (Culinary) - 8" PVC
- (Unless otherwise specified on plans)

NOTE

1. 10' wide Public Utility and Drainage Easements (P.U.&D.E.) on front lot lines as indicated by dashed lines except as otherwise shown.

ENGINEER:
 Great Basin Engineering, Inc.
 c/o Andy Hubbard
 5746 South 1475 East Suite 200
 Ogden, Utah 84405
 (801) 394-4515

DEVELOPER:
 Ed Green
 2150 North Valley View Drive
 Layton Utah, 84040
 Ogden, Utah 84405
 (801) 540-3400

GREAT BASIN ENGINEERING

5746 SOUTH 1475 EAST, OGDEN, UTAH 84405
 MAIN (801) 394-4515 FAX (801) 392-7944
 WWW.GREATBASINENGINEERING.COM

Preliminary Plan
Summerset Farms
 Weber County, Utah
 A part of Section 28, T6N, R2W, SLB&M, U.S. Survey

6 Feb, 2019

SHEET NO.

2 of 2

PRELIMINARY PLAN