

EDGEWATER BEACH RESORT PHASE 3

A PLANNED RESIDENTIAL UNIT DEVELOPMENT (P.R.U.D.)

PART OF THE SOUTHWEST QUARTER OF SECTION 13, TOWNSHIP 6 NORTH, RANGE 1 EAST, SALT LAKE BASE AND MERIDIAN, U.S. SURVEY
WEBER COUNTY, UT
OCT 2017

BASIS OF BEARING

THE BASIS OF BEARING IS N.00°25'49"E. (RECORD N.00°25'44"E.) 5316.87' BETWEEN THE SOUTHWEST AND THE NORTHWEST CORNER OF SECTION 13, T.6N., R.1E., SLB&M.

NARRATIVE

THE PURPOSE OF THIS SURVEY IS TO CREATE A SUBDIVISION PLAT TO BE KNOWN AS "EDGEWATER BEACH RESORT PHASE 3". FOUND SECTION CORNERS AND REFERENCE MONUMENTS WERE USED TO DETERMINE THE BASIS OF BEARING. THE BEARING ALONG THE WEST LINE OF SECTION 13 AS IT IS SHOWN ON A RECORD OF SURVEY TITLED "A PORTION OF THE PINEVIEW FEDERAL BOUNDARY PROJECT FOR PROPOSED EDGEWATER BEACH RESORT AT SNOWBASIN ROAD & LAKESIDE VILLAGE CONDOMINIUMS", SURVEY FILING NO. 003429, WAS HELD AS THE BASIS OF BEARING. THE PROPERTY IS BOUNDED BY THE USA LAND ON THE EAST, EDGEWATER BEACH RESORT PHASE 1-1ST AMENDMENT ON THE WEST, AND STATE HIGHWAY 39 ON THE SOUTH. HIGHWAY RIGHT OF WAY MARKERS WERE FOUND ON THE GROUND AND HELD FOR THE LOCATION OF THE HIGHWAY AND THE NORTH LINE OF THIS SURVEY WAS ESTABLISHED BY THE PROPERTY OWNER TO BE THE NORTH LINE OF THIS SUBDIVISION.

NOTES

- ALL PATIOS, DECKS AND DRIVEWAYS TO PADS ARE DEDICATED LIMITED COMMON AREAS. THEY ARE SET ASIDE AND RESERVED FOR THE OWNERS OF THE RESPECTIVE PAD TO WHICH THEY ARE ATTACHED.
- ALL OTHER AREAS CONTAINED WITHIN THE PROJECT, BUT NOT SHOWN WITH DIAGONAL STRIPE OR CROSS HATCHED LINES ARE DEDICATED AS COMMON AREA, INCLUDING PARKING, PRIVATE STREETS, PUBLIC UTILITY, STORM WATER DETENTION AND DRAINAGE EASEMENT AREA. COMMON AREAS ARE "TO BE USED FOR RECREATIONAL AND OPEN SPACE PURPOSES FOR THE BENEFIT OF EACH EDGEWATER BEACH RESORT HOA, INC. MEMBER IN COMMON AND GRANT AND DEDICATE TO THE GOVERNING AUTHORITY A PERPETUAL OPEN SPACE RIGHT AND EASEMENT ON AND OVER THE COMMON AREA TO GUARANTEE THAT THE COMMON AREAS REMAIN OPEN AND UNDEVELOPED EXCEPT FOR APPROVED RECREATIONAL, PARKING AND OPEN SPACE PURPOSES".
- CULINARY WATERLINE AND THE SANITARY SEWER MAIN TO BE OWNED AND MAINTAINED BY LAKEVIEW WATER SYSTEM AND MOUNTAIN SEWER CORPORATION RESPECTIVELY.
- THERE ARE NO CONVERTIBLE OR WITHDRAWALABLE AREAS IN THIS PROJECT PHASE.
- ALL BUILDING TIE DIMENSIONS ARE PERPENDICULAR TO BOUNDARY LINE OR ROAD CENTERLINE.
- ALL AREAS LABELED AS COMMON AREA, INCLUDING PRIVATE STREETS ARE TO BE DESIGNATED AS A PUBLIC UTILITY EASEMENT. SEE OWNERS DEDICATION AND CONSENT TO RECORD FOR ADDITIONAL INFORMATION.

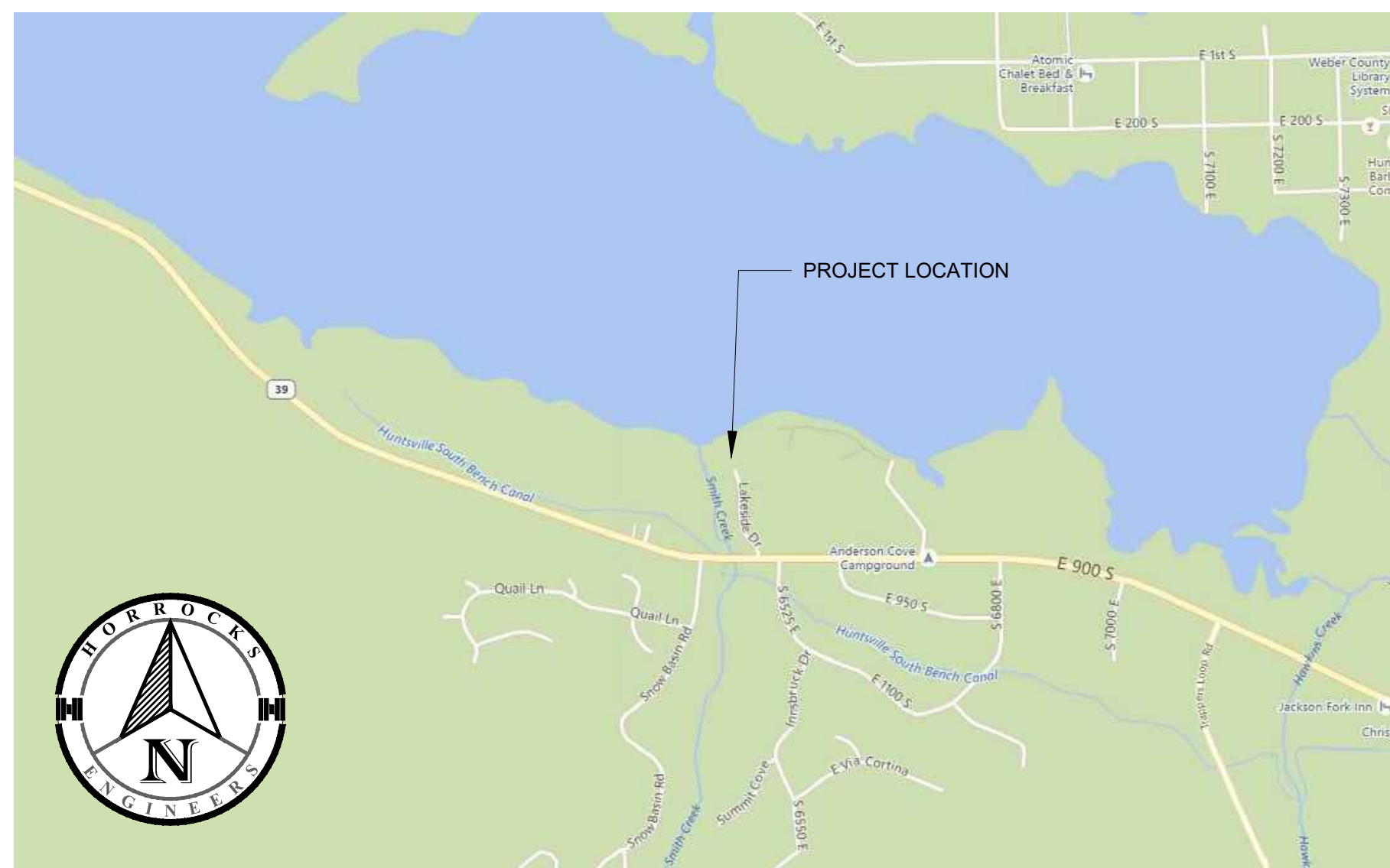

VICINITY MAP
NO SCALE

DEVELOPER

JACK FISHER HOMES
BROCK LOOMIS
1148 W LEGACY CROSSING BLVD., STE 400
CENTERTVILLE, UTAH 84014
801-335-8500

LAND USE

TOTAL AREA 208,800 S.F. (4.79 ACRES)
COMMON AREA 149,140 S.F. (3.42 ACRES) 71%
ROAD AREA 49,420 S.F. (1.13 ACRES)
OPEN AREA 99,720 S.F. (2.29 ACRES)
PRIVATELY OWNED BUILDING 59,660 S.F. (1.37 ACRES) 29%

OWNERS DEDICATION AND CONSENT TO RECORD

KNOW ALL MEN BY THESE PRESENTS: _____ WHICH IS THE OWNER OF THE TRACT OF LAND DESCRIBED HEREON MAKE THIS CERTIFICATE FOR AND ON BEHALF OF SAID CORPORATION AND HAVE CAUSED; 1. A SURVEY TO BE MADE AND 2. THIS PLANNED RESIDENTIAL UNIT DEVELOPMENT PLAT, CONSISTING OF (2) SHEETS. WE THE UNDERSIGNED OWNERS OF THE HEREIN DESCRIBED TRACT OF LAND, DO HEREBY SET APART AND SUBDIVIDE THE SAME INTO UNITS AND PADS AND PUBLIC AND PRIVATE STREETS AS SHOWN HEREON AND NAME SAID TRACT EDGEWATER BEACH RESORT PHASE 3, A PLANNED RESIDENTIAL UNIT DEVELOPMENT, AND DO HEREBY:

DEDICATE TO PUBLIC USE ALL THOSE PARTS OR PORTIONS OF SAID TRACT OF LAND DESIGNATED AS PRIVATE STREETS, THE SAME TO BE USED AS PUBLIC THOROUGHFARES. DEDICATE AND RESERVE UNTO THEMSELVES, THEIR HEIRS, THEIR GRANTEEES AND ASSIGNS, A RIGHT-OF-WAY TO BE USED IN COMMON WITH ALL OTHERS WITHIN SAID SUBDIVISION (AND THOSE ADJOINING SUBDIVISIONS THAT MAY BE SUBDIVIDED BY THE UNDERSIGNED OWNERS, THEIR SUCCESSORS, OR ASSIGNS) ON, OVER AND ACROSS ALL THOSE PORTIONS OR PARTS OF SAID TRACT OF LAND DESIGNATED ON SAID PLAT AS PRIVATE STREETS AS ACCESS TO THE INDIVIDUAL UNITS AND PADS, TO BE MAINTAINED BY A UNIT AND PAD OWNERS ASSOCIATION WHOSE MEMBERSHIP CONSISTS OF SAID OWNERS, THEIR GRANTEEES, SUCCESSORS, OR ASSIGNS. GRANT AND CONVEY TO EDGEWATER BEACH RESORT HOA, INC., ALL THOSE PARTS OR PORTIONS OF SAID TRACT OF LAND DESIGNATED AS COMMON AREAS TO BE USED FOR RECREATIONAL AND OPEN SPACE PURPOSES FOR THE BENEFIT OF EACH EDGEWATER BEACH RESORT HOA, INC. MEMBER IN COMMON WITH ALL OTHERS IN THE SUBDIVISION, THE SAME TO BE USED FOR THE INSTALLATION MAINTENANCE AND OPERATION OF PUBLIC UTILITY SERVICE LINE, STORM DRAINAGE FACILITIES, IRRIGATION CANALS OR FOR THE PERPETUAL PRESERVATION OF WATER CHANNELS IN THEIR NATURAL STATE WHICHEVER IS APPLICABLE AS MAY BE AUTHORIZED BY THE GOVERNING AUTHORITY, WITH NO BUILDINGS OR STRUCTURES BEING ERECTED WITHIN SUCH EASEMENTS. GRANT AND DEDICATE UNTO ALL OWNERS OF UNITS AND PADS UPON SUCH LAND DRAINS, AN EASEMENT OVER SUCH LAND DRAINS FOR THE PURPOSE OF PERPETUAL MAINTENANCE AND OPERATION. DEDICATE, GRANT AND CONVEY TO THE GOVERNING AUTHORITY, OR ITS DESIGNEE, ALL THOSE PARTS OR PORTIONS OF SAID TRACT OF LAND DESIGNATED AS PARKS THE SAME TO BE USED AS A PUBLIC OPEN SPACE. ALL COMMON AREA, INCLUDING THE PRIVATE STREETS, IS CONSIDERED TO BE AN EASEMENT FOR PUBLIC UTILITY AND DRAINAGE PURPOSES.

SIGNED THIS _____ DAY OF _____, 20____.

BOUNDARY DESCRIPTION

PART OF THE SOUTHWEST QUARTER OF SECTION 13, TOWNSHIP 6 NORTH, RANGE 1 EAST, SALT LAKE BASE AND MERIDIAN, U.S. SURVEY. DESCRIBED AS FOLLOWS:

BEGINNING AT A POINT ON THE NORTH RIGHT OF WAY LINE OF STATE HIGHWAY 39, SAID POINT BEING THE NORTHWEST CORNER OF EDGEWATER BEACH RESORT PHASE 1 - 1ST AMENDMENT AND LIES N00°25'49"E 602.20 FEET AND N89°34'11"E 7.10 FEET FROM THE SOUTHWEST CORNER OF SECTION 13; THENCE CONTINUING N00°09'59"E 302.43 FEET ALONG THE WESTERLY BOUNDARY OF SAID SUBDIVISION; THENCE NORTH 63°12'30" EAST 319.26 FEET; THENCE SOUTH 79°03'30" EAST 319.70 FEET; THENCE SOUTH 35°45'20" EAST 101.60 FEET; THENCE SOUTH 0°20'30" WEST 183.33 FEET TO THE NORTH PROPERTY LINE OF EDGEWATER PHASE 2; THENCE ALONG SAID BOUNDARY NORTH 89°39'30" WEST 47.12 FEET; THENCE NORTH 60°22'18" WEST 75.49 FEET; THENCE SOUTH 72°01'51" WEST 211.70 FEET TO A POINT ON A 66.72 FOOT RADIUS NON-TANGENT CURVE TO THE RIGHT (CENTER BEARS S9°42'22"W); THENCE RUNNING SOUTHWESTERLY ALONG SAID CURVE 147.18 FEET THROUGH A CENTRAL ANGLE OF 126°22'53" (CHORD S72 54°23'W 119.10') TO A POINT ON A LINE; THENCE S65°29'31"W 139.65 FEET; THENCE NORTH 89°34'11" WEST 103.01 FEET TO THE POINT OF BEGINNING.

CONTAINING 208,760 SQUARE FEET OR 4.793 ACRES.

SURVEYOR'S CERTIFICATE

I, C. DAVID MCKINNEY, DO HEREBY CERTIFY THAT I AM A PROFESSIONAL LAND SURVEYOR, AND THAT I HOLD A LICENSE IN ACCORDANCE WITH TITLE 58, CHAPTER 22, PROFESSIONAL ENGINEERS AND PROFESSIONAL LAND SURVEYORS LICENSING ACT, UTAH CODE ANNOTATED, 1953 AS AMENDED CERTIFICATE NUMBER 5251295. I FURTHER CERTIFY THAT BY AUTHORITY OF THE OWNERS, I HAVE MADE A SURVEY OF THE TRACT OF LAND SHOWN ON THIS PLAT AND DESCRIBED BELOW, HAVE SUBDIVIDED SAID TRACT OF LAND INTO LOTS, STREETS, AND EASEMENTS, HAVE COMPLETED A SURVEY OF THE PROPERTY DESCRIBED ON THIS PLAT IN ACCORDANCE WITH SECTION 17-23-17, UTAH CODE ANNOTATED, 1953 AS AMENDED, HAVE VERIFIED ALL MEASUREMENTS, AND WILL PLACE MONUMENTS AS REPRESENTED ON THE PLAT. I FURTHER CERTIFY THAT ALL LOTS MEET THE REQUIREMENTS OF THE WEBER COUNTY LAND USE CODE.



WEBER COUNTY SURVEYOR:

I HEREBY CERTIFY THAT THE WEBER COUNTY SURVEYOR'S OFFICE HAS REVIEWED THIS PLAT AND ALL CONDITIONS FOR APPROVAL BY THIS OFFICE HAVE BEEN SATISFIED. THE APPROVAL OF THIS PLAT BY THE WEBER COUNTY SURVEYOR DOES NOT RELIEVE THE LICENSED LAND SURVEYOR WHO EXECUTED THIS PLAT FROM THE RESPONSIBILITIES AND/OR LIABILITIES ASSOCIATED THEREWITH.

SIGNED THIS _____ DAY OF _____.

ACKNOWLEDGMENT

STATE OF UTAH)
COUNTY OF _____)ss.

ON THE _____ DAY OF _____, 20____, PERSONALLY APPEARED BEFORE ME, THE UNDERSIGNED NOTARY PUBLIC, _____ SIGNER(S) OF THE ABOVE OWNER'S DEDICATION AND CERTIFICATION, WHO BEING BY ME DULY SWORN, DID ACKNOWLEDGE TO ME _____ SIGNED IT FREELY, VOLUNTARILY, AND FOR THE PURPOSES THEREIN MENTIONED.

COMMISSION EXPIRES NOTARY PUBLIC

ACKNOWLEDGMENT

STATE OF UTAH)
COUNTY OF _____)ss.

ON THE _____ DAY OF _____, 20____, PERSONALLY APPEARED BEFORE ME, THE UNDERSIGNED NOTARY PUBLIC, _____ BEING BY ME DULY SWORN, ACKNOWLEDGED TO ME THEY ARE _____ AND _____ OF SAID CORPORATION AND THAT THEY SIGNED THE ABOVE OWNER'S DEDICATION AND CERTIFICATION FREELY, VOLUNTARILY, AND IN BEHALF OF SAID CORPORATION FOR THE PURPOSES THEREIN MENTIONED.

COMMISSION EXPIRES NOTARY PUBLIC

WEBER COUNTY PLANNING COMMISSION APPROVAL

THIS IS TO CERTIFY THAT THIS SUBDIVISION PLAT WAS DULY APPROVED BY THE WEBER COUNTY PLANNING COMMISSION. SIGNED THIS _____ DAY OF _____, 20____.

CHAIRMAN, WEBER COUNTY PLANNING COMMISSION

WEBER COUNTY ENGINEER

I HEREBY CERTIFY THAT THE REQUIRED PUBLIC IMPROVEMENT STANDARDS AND DRAWINGS FOR THIS SUBDIVISION CONFORM WITH THE COUNTY STANDARDS AND THE AMOUNT OF THE FINANCIAL GUARANTEE IS SUFFICIENT FOR THE INSTALLATION OF THESE IMPROVEMENTS.

SIGNED THIS _____ DAY OF _____, 20____

WEBER COUNTY ENGINEER

WEBER COUNTY COMMISSION ACCEPTANCE

THIS IS TO CERTIFY THAT THIS SUBDIVISION PLAT, THE DEDICATION OF STREETS AND OTHER PUBLIC WAYS AND FINANCIAL GUARANTEE OF PUBLIC IMPROVEMENTS ASSOCIATED WITH THIS SUBDIVISION, THEREON ARE HEREBY APPROVED AND ACCEPTED BY THE COMMISSIONERS OF WEBER COUNTY, UTAH. SIGNED THIS _____ DAY OF _____, 20____.

CHAIRMAN, WEBER COUNTY COMMISSION

ATTEST

TITLE

WEBER COUNTY RECORDER

ENTRY NO. _____ FEE PAID _____
FILED FOR RECORD AND RECORDED,
_____ AT _____ IN BOOK _____
OF THE OFFICIAL RECORDS, PAGE _____
RECORDED FOR:

WEBER COUNTY RECORDER

DEPUTY

WEBER COUNTY ATTORNEY

I HAVE EXAMINED THE FINANCIAL GUARANTEE AND OTHER DOCUMENTS ASSOCIATED WITH THIS SUBDIVISION PLAT, AND IN MY OPINION THEY CONFORM WITH THE COUNTY ORDINANCE APPLICABLE THERETO AND NOW IN FORCE AND AFFECT. SIGNED THIS _____ DAY OF _____, 20____.

WEBER COUNTY ATTORNEY

WEBER-MORGAN HEALTH DEPARTMENT

I HEREBY CERTIFY THAT THE SOILS, PERCOLATION RATES, AND SITE CONDITIONS FOR THIS SUBDIVISION HAVE BEEN INVESTIGATED BY THIS OFFICE AND ARE APPROVED FOR ON-SITE WASTEWATER DISPOSAL SYSTEMS. SIGNED THIS _____ DAY OF _____, 20____.

DIRECTOR, WEBER-MORGAN HEALTH DEPARTMENT



2162 West Grove Pkwy., Suite 400
Pleasant Grove, UT 84062
(801) 763-5100

EDGEWATER BEACH RESORT PHASE 3

A PLANNED RESIDENTIAL UNIT DEVELOPMENT (P.R.U.D.)

PART OF THE SOUTHWEST QUARTER OF SECTION 13, TOWNSHIP 6
NORTH, RANGE 1 EAST, SALT LAKE BASE AND MERIDIAN, U.S. SURVEY
WEBER COUNTY, UT
OCT 2017



0 30' 60'
SCALE: 1" = 30'

CRV	LENGTH	RADIUS	DELTA	CHORD DIR.
C1	4.71	3.00	90°00'00"	S62°58'09"E
C2	4.71	3.00	90°00'00"	N27°01'51"E
C3	4.71	3.00	90°00'00"	S62°58'09"E
C4	4.71	3.00	89°53'38"	N26°58'40"E
C5	5.42	36.00	8°37'36"	N67°36'42"E
C6	4.48	3.00	85°35'18"	S73°54'27"E
C7	24.00	54.00	25°27'53"	N46°09'15"E
C8	13.14	4.50	167°16'03"	N27°03'20"E
C9	24.00	54.00	25°27'53"	N7°57'25"E
C10	7.24	5.00	82°59'43"	N53°16'40"W
C11	3.89	36.00	6°11'20"	N14°52'29"W
C12	77.41	73.00	60°45'21"	N48°20'49"W
C13	66.48	113.00	33°42'31"	S84°25'14"W
C14	53.16	87.00	35°00'38"	N83°46'11"E
C15	19.79	15.00	75°34'51"	S40°56'05"E
C16	55.37	214.00	14°49'29"	S10°33'24"E
C17	23.56	15.00	90°00'00"	S27°01'51"W
C18	24.26	23.00	60°26'24"	N77°44'56"W
C19	109.71	52.00	120°52'49"	S72°01'51"W
C20	24.26	23.00	60°26'24"	S41°48'39"W
C21	4.71	3.00	90°00'00"	N62°58'09"W
C22	4.77	3.00	91°08'34"	S27°36'08"W
C23	23.97	15.00	91°33'23"	N61°02'53"W
C24	28.60	136.00	12°02'57"	N9°14'43"W
C25	71.45	74.00	55°19'20"	N30°52'54"W
C26	43.14	89.00	27°46'12"	N72°25'40"W
C27	42.39	28.00	86°44'35"	N42°56'29"W
C28	36.79	28.00	75°16'39"	N38°04'09"E
C29	10.45	5.00	119°46'14"	S44°24'25"E
C30	9.56	5.00	109°33'31"	N70°15'28"E
C31	41.54	46.00	51°44'32"	S29°05'30"E
C32	34.49	164.00	12°02'57"	S9°14'43"E
C33	25.17	15.00	96°08'35"	S32°48'06"W
C34	47.71	286.00	9°33'26"	S85°39'06"W
C35	4.71	3.00	90°00'00"	S44°34'11"E
C36	65.78	340.00	11°05'04"	N84°53'17"E
C37	4.68	3.00	89°27'28"	N34°04'29"E
C38	26.43	314.00	4°49'25"	N76°23'30"E
C39	7.78	5.00	89°09'16"	S61°26'34"E
C40	5.89	321.00	1°03'05"	N72°33'24"E
C41	3.14	2.00	90°00'00"	N27°01'51"E
C42	24.26	23.00	60°26'24"	S77°44'56"E
C43	28.03	52.00	30°52'49"	S62°58'09"E
C44	24.26	23.00	60°26'24"	S48°11'21"E
C45	28.21	66.72	24°13'26"	N72°01'51"E
C46	24.26	23.00	60°26'24"	N12°15'04"E
C47	28.03	52.00	30°52'49"	N27°01'51"E
C48	24.26	23.00	60°26'24"	N41°48'39"E
C49	48.22	45.50	60°43'10"	N47°59'40"W
C51	4.71	3.00	90°00'00"	S56°16'30"W
C55	4.71	3.00	90°00'00"	N33°43'30"W
C57	27.34	15.00	104°25'09"	S49°03'55"W
C59	4.71	3.00	90°00'00"	S48°08'39"E
C63	4.71	3.00	90°00'00"	S41°51'21"W
C65	48.13	186.00	14°49'29"	S10°33'24"E
C67	23.56	15.00	90°00'00"	S62°58'09"E
C69	23.56	15.00	90°00'00"	N27°01'51"E
C71	58.46	66.72	50°12'12"	N34°49'02"E
C72	60.50	66.72	51°57'15"	S69°52'48"E

LINE #	LENGTH	DIRECTION
L1	15.68	N72°01'51"E
L3	4.00	S17°58'09"E
L4	66.00	N72°01'51"E
L5	4.00	N17°58'09"W
L7	14.00	N72°01'51"E
L9	4.00	S17°58'09"E
L10	110.00	N72°01'51"E
L11	4.00	N17°58'09"W
L15	15.12	S31°06'48"E
L17	13.67	N56°34'42"W
L19	13.67	S69°18'38"E
L21	13.31	S85°13'29"W
L24	46.47	N17°58'09"W
L26	163.93	N78°43'30"W
L28	28.10	S18°16'10"E
L30	3.94	S78°43'30"E
L32	81.84	S3°08'39"E
L34	5.85	S17°58'09"E
L36	28.17	S72°01'51"W
L40	25.46	S72°01'51"W
L42	13.00	N17°58'09"W
L43	27.00	S72°01'51"W
L44	13.00	S17°58'09"E
L47	4.99	N15°16'12"W
L49	61.04	N3°13'14"W
L51	3.90	N58°32'34"W
L54	18.19	N0°25'49"E
L55	20.00	N89°34'11"W
L56	120.00	S0°25'49"W
L57	20.00	S89°34'11"E
L58	17.35	N0°25'49"E
L61	12.62	S15°28'42"W
L62	25.00	S74°31'18"E
L63	11.68	N15°28'42"E
L66	61.04	S3°13'14"E
L68	4.50	S15°16'12"E
L71	19.64	N89°34'11"W
L72	28.00	S0°25'49"W
L73	5.00	S89°34'11"E
L75	23.00	S0°25'49"W
L76	11.64	S89°34'11"E
L78	23.01	N10°39'15"W
L82	2.03	S16°51'56"E
L84	61.99	N72°01'51"E
L85	5.00	N17°58'09"W
L87	10.48	N72°01'51"E
L95	21.96	N78°43'30"W
L96	17.50	S11°16'30"W
L97	58.00	N78°43'30"W
L98	17.50	N11°16'30"E
L99	11.83	N78°43'30"W
L100	9.75	S3°08'39"E
L101	17.50	N86°51'21"E
L102	31.00	S3°08'39"E
L103	17.53	S86°51'21"W
L104	19.86	S3°08'39"E
L105	5.85	S17°58'09"E
L106	123.44	N72°01'51"E
L107	39.47	N17°58'09"W

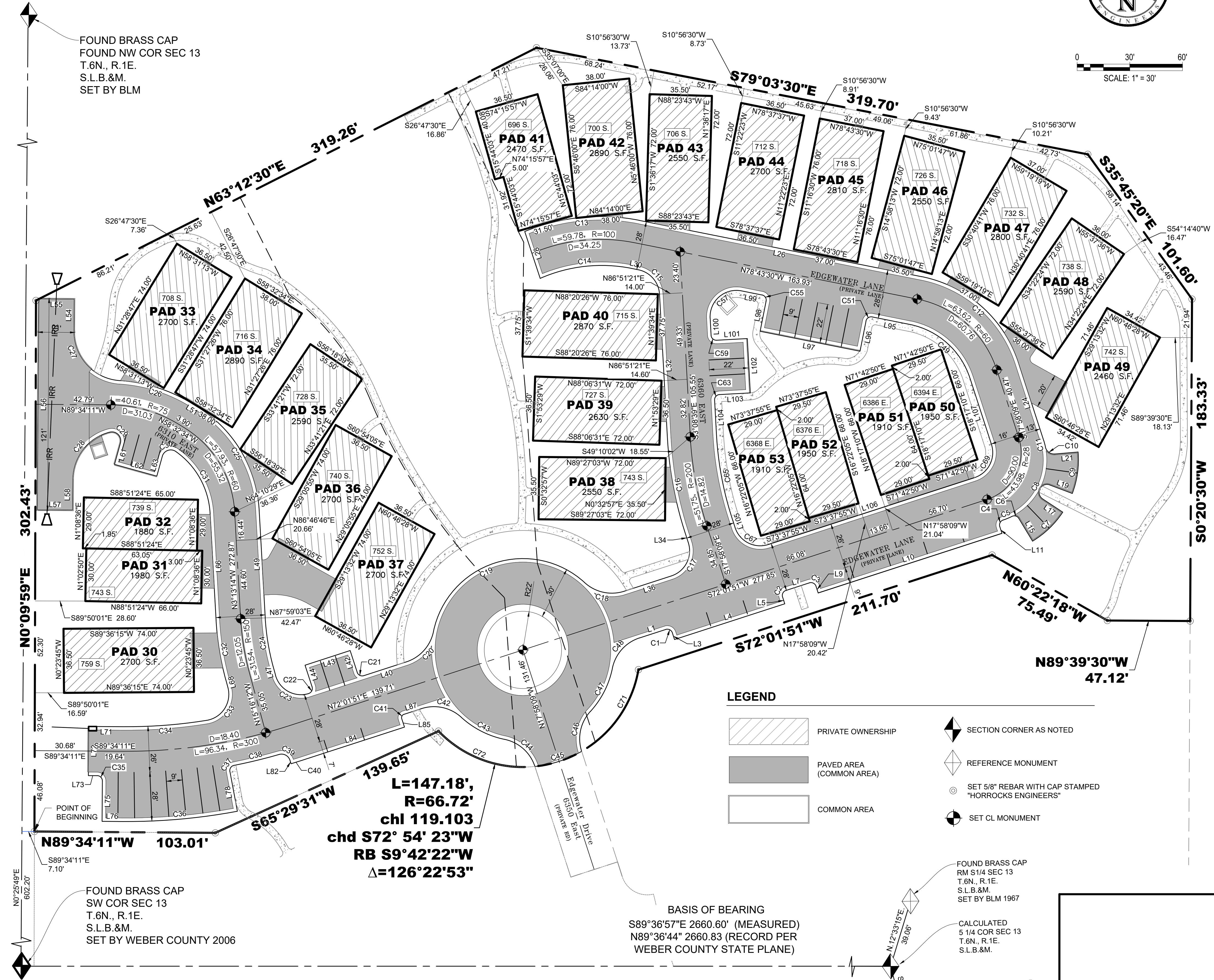

FOUND BRASS CAP
FOUND NW COR SEC 13
T.6N., R.1E.
S.L.B.&M.
SET BY BLM

FOUND BRASS CAP
SW COR SEC 13
T.6N., R.1E.
S.L.B.&M.
SET BY WEBER COUNTY 2006

BASIS OF BEARING
S89°36'57"E 2660.60' (MEASURED)
N89°36'44" 2660.83 (RECORD PER
WEBER COUNTY STATE PLANE)



FOUND BRASS CAP
RM S1/4 SEC 13
T.6N., R.1E.
S.L.B.&M.
SET BY BLM 1967

CALCULATED
5/4 COR SEC 13
T.6N., R.1E.
S.L.B.&M.

FOUND BRASS CAP
RM S1/4 SEC 13
T.6N., R.1E.
S.L.B.&M.
SET BY BLM 1967

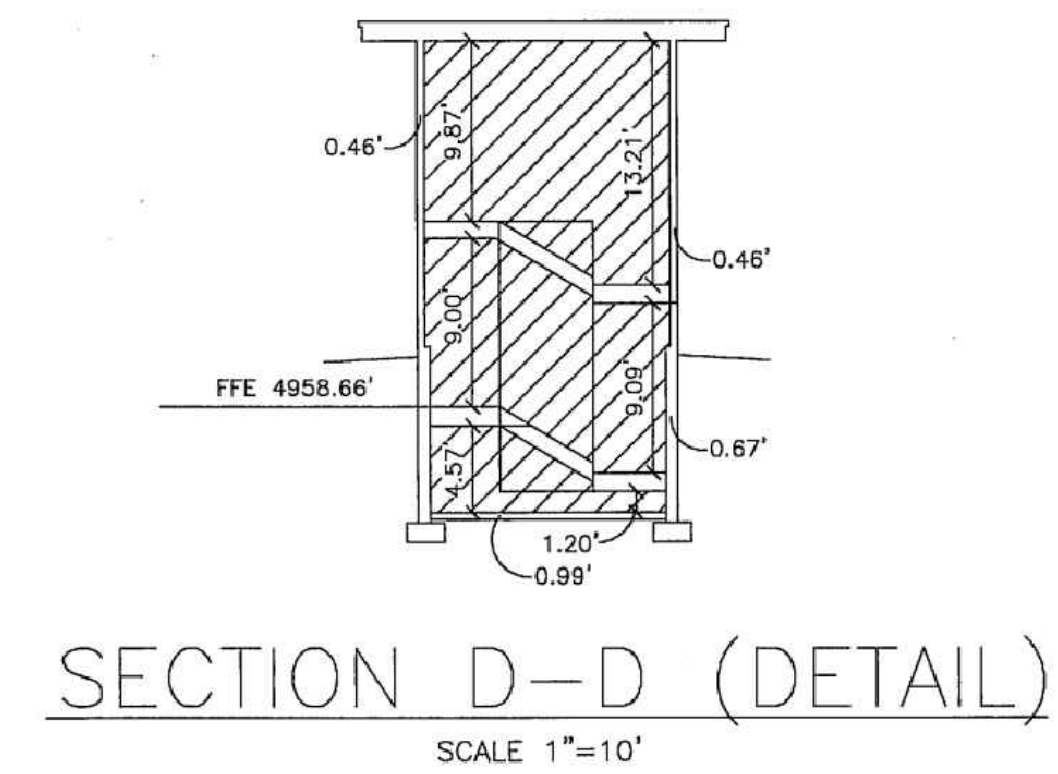
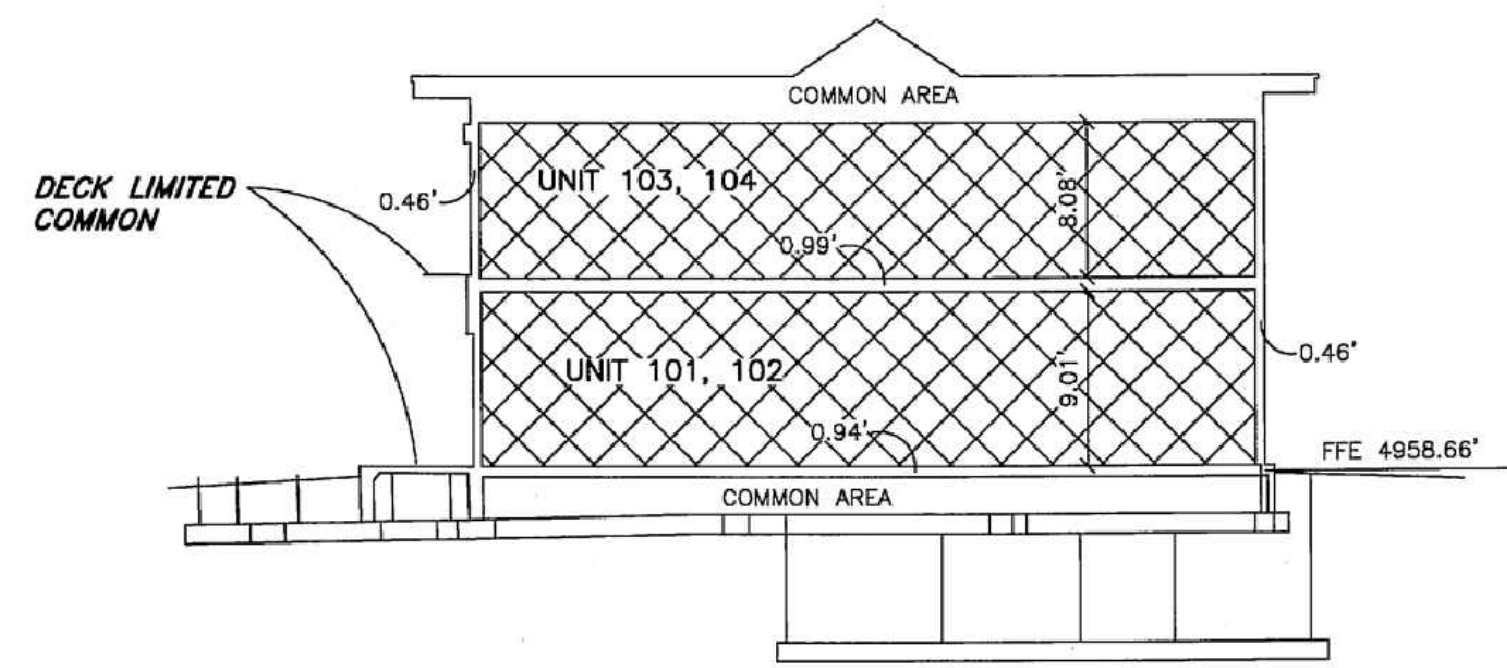
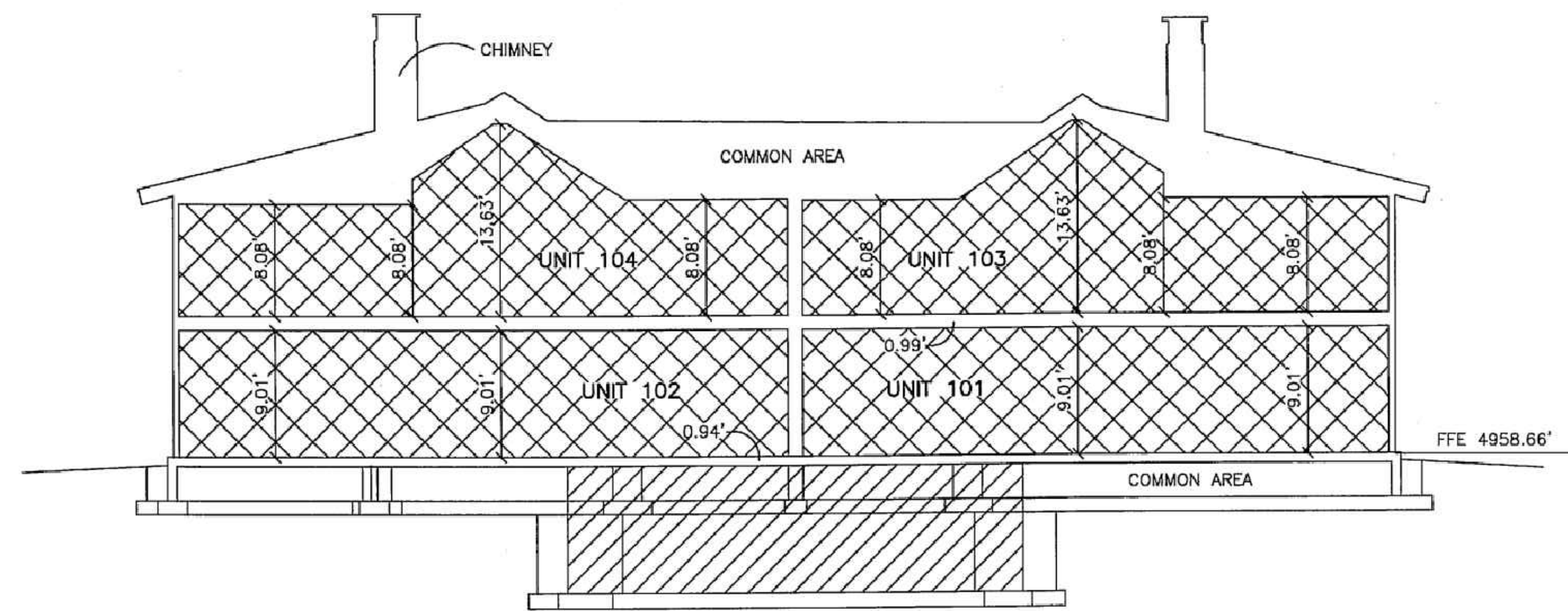
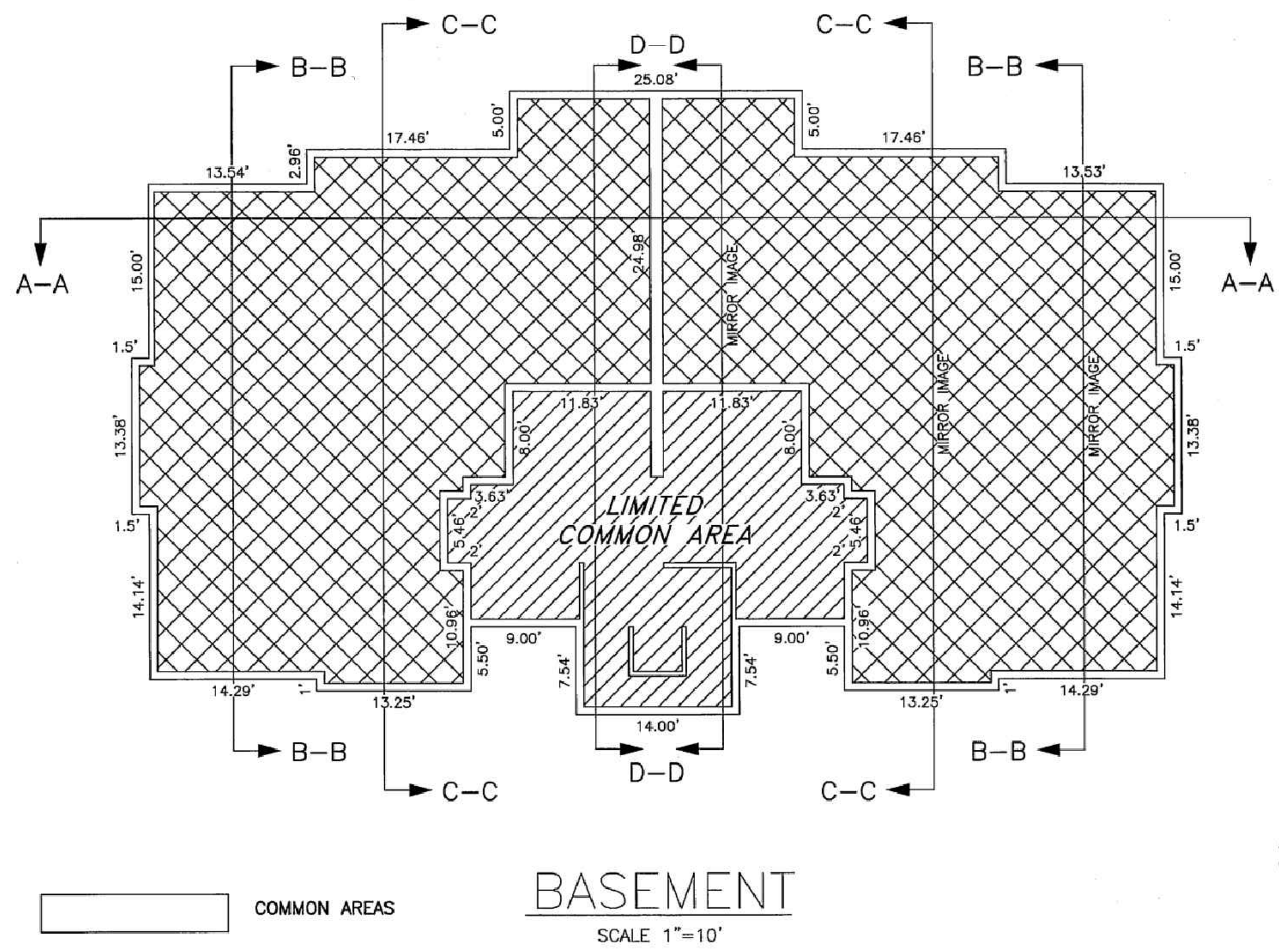
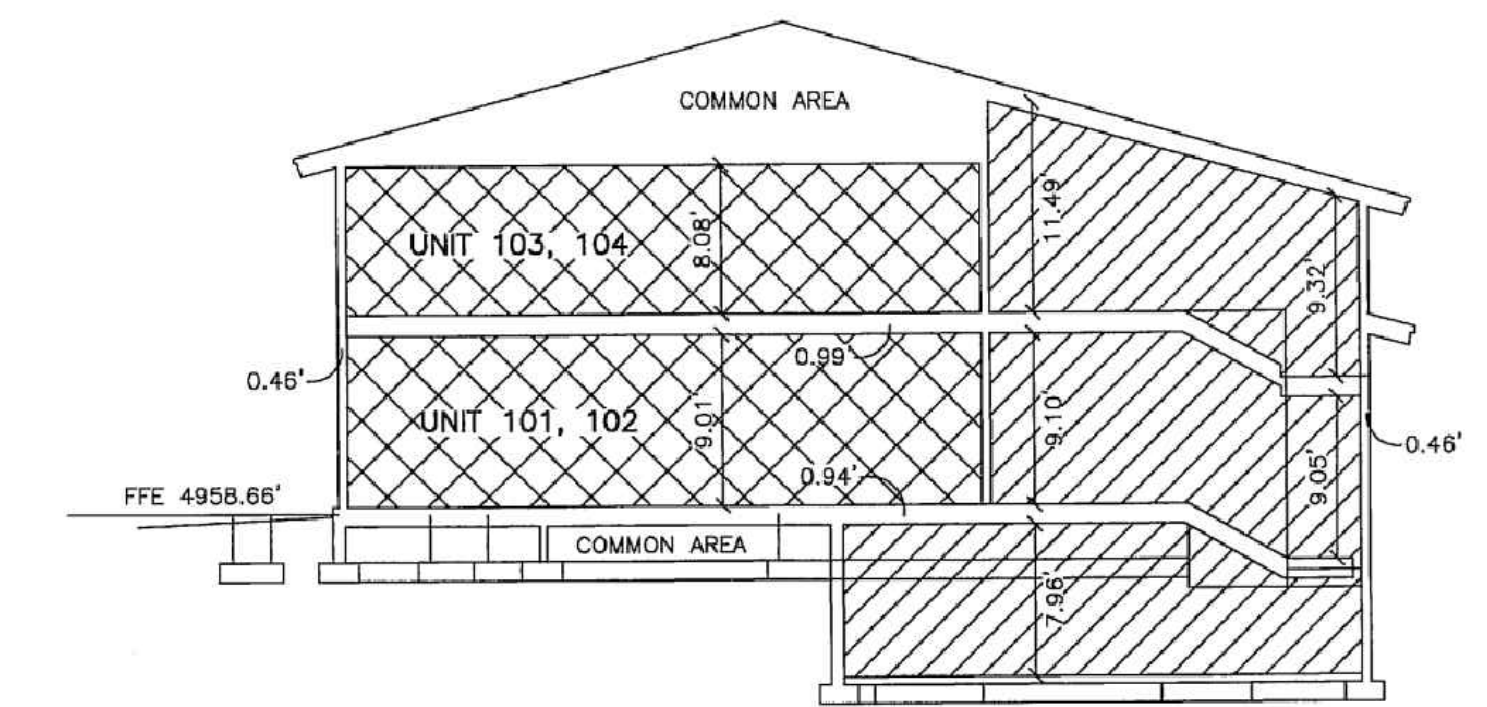
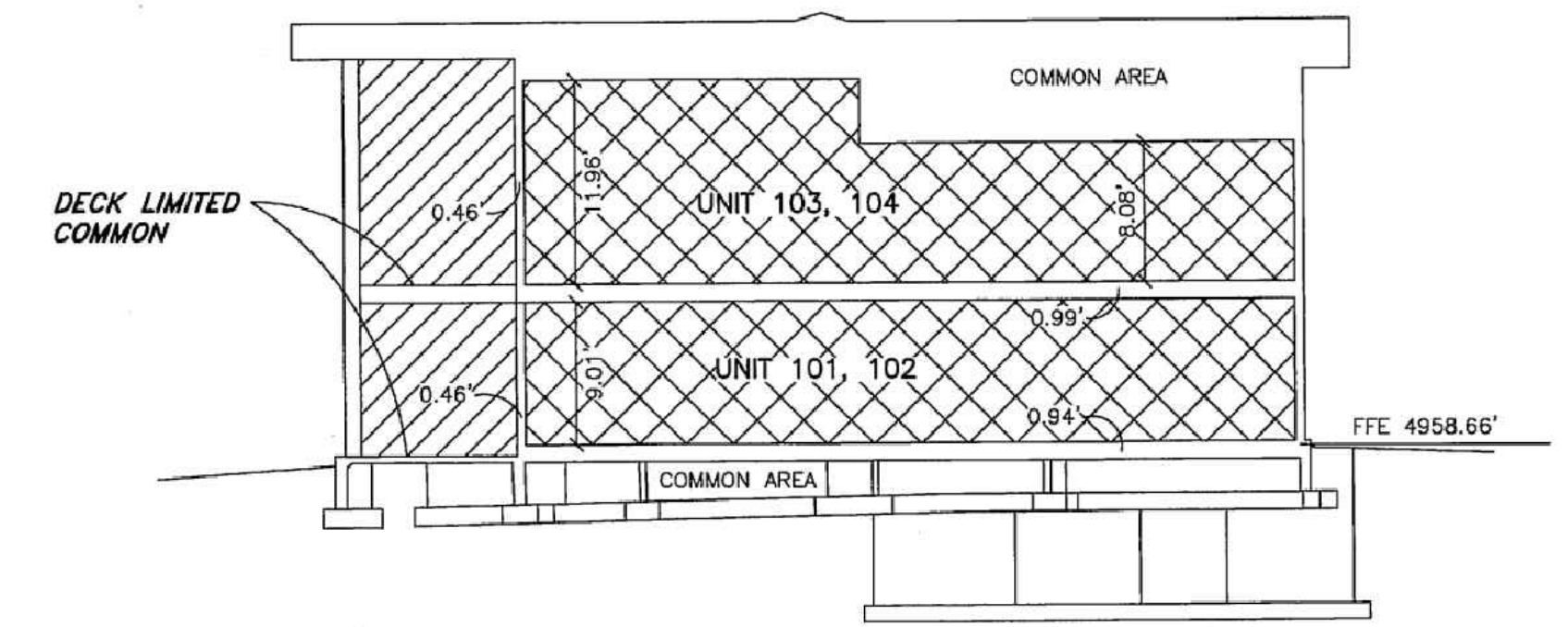
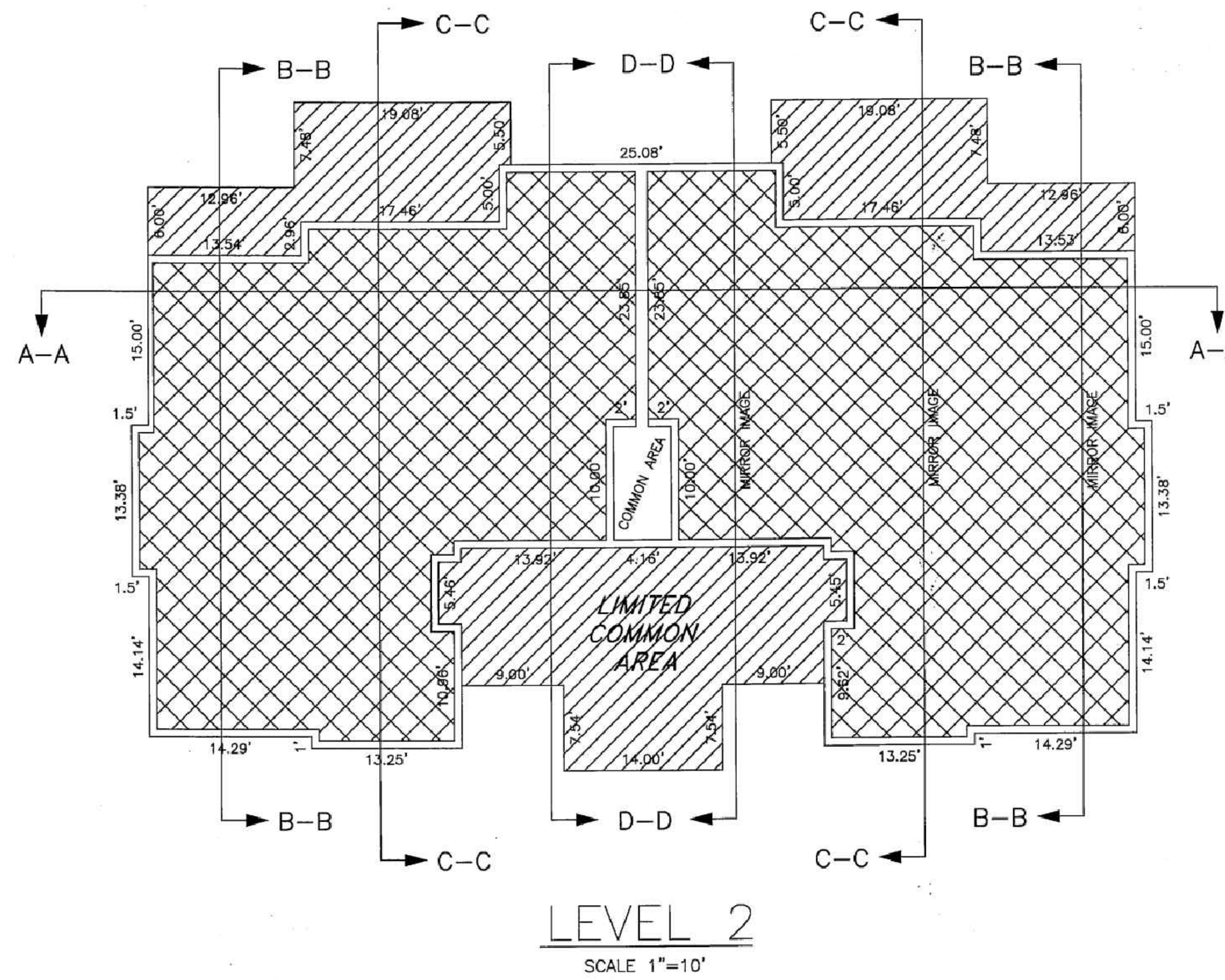
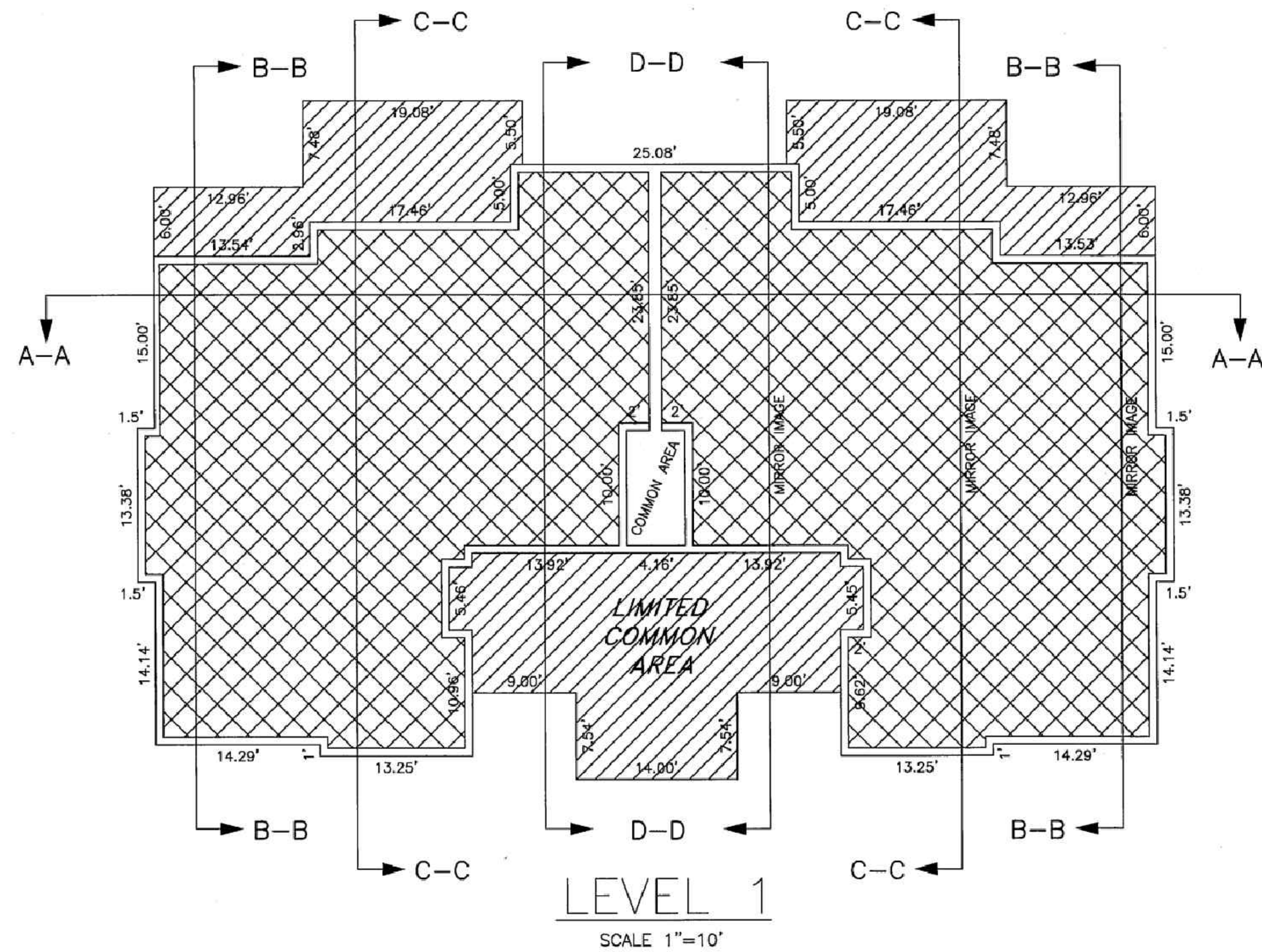
C:\Users\samb\AppData\Local\Temp\AspPublish_12760\EDGEWATER PHASE 3 SET.dwg - PLAT 2 - 3/09/2018 11:44am_samb



-  COMMON AREAS
-  LIMITED COMMON AREAS AND FACILITIES
-  PRIVATE OWNERSHIP

CONDOMINIUM NOTES:
UNITS 101-104 ARE CONDOMINIUM UNITS
ALL DRIVEWAYS, PATIOS, DECKS, BALCONIES ON UNITS 101-104 ARE CONSIDERED LIMITED COMMON AREA. THEY ARE SET ASIDE AND RESERVED FOR THE USE OF THE RESPECTIVE CONDOMINIUM UNIT TO WHICH THEY ARE ATTACHED OR APPURTENANT.
DIMENSIONS ON BUILDINGS VARY SLIGHTLY. AS-BUILT DIMENSIONS WILL CONTROL.