

DYNAMIC STRUCTURES

1887 North 1120 West, Provo, Utah 84604 (ph) 801.356.1140 (fax) 801.356.0001

Structural Calculations for:

HORIZON NEIGHBORHOOD CABINS AT SUMMIT POWDER MOUNTAIN 1000 MODEL EDEN, UTAH

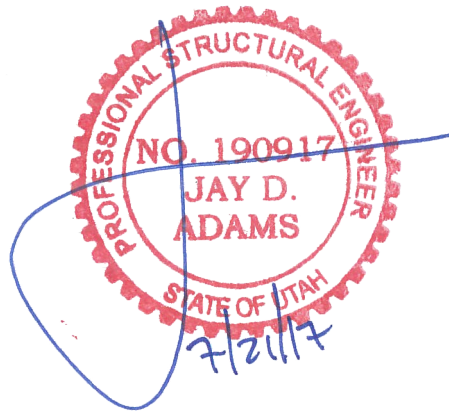

July 21, 2017

Service Prepared for:

SIGNATURE BUILDERS

PROJECT: HORIZON NEIGHBORHOOD CABINS
AT SUMMIT POWDER MOUNTAIN
1000 MODEL
EDEN, UTAH

CLIENT: SIGNATURE BUILDERS

SCOPE: PROVIDE STRUCTURAL ANALYSIS, STRUCTURAL PLANS AND
STRUCTURAL DETAIL SHEETS FOR A MOUNTAIN CABIN

CODE CRITERIA: 2015 IBC
SEISMIC DESIGN CATEGORY D
WIND: 115 MPH EXP. B (STRENGTH)
SNOW: $P_g = 274$ PSF EXP 0.7 $P_f = 192$ PSF
SOIL: 1500 psf

MATERIALS

STEEL:

ROLLED SECTIONS:	ASTM A992 $F_y = 50$ ksi
HSS COLUMNS:	ASTM A500 GRADE B $F_y = 46$ ksi
PLATE, CHANNELS AND ANGLES:	ASTM A36 $F_y = 36$ KSI

CONCRETE:

STRENGTH: (DESIGN)	2500 psi
(CONSTRUCTION)	SEE PLAN NOTES
REINFORCING STEEL:	GRADE 60

WOOD:

STRUCTURAL MEMBERS	DF #2
TIMBERS:	DF #1

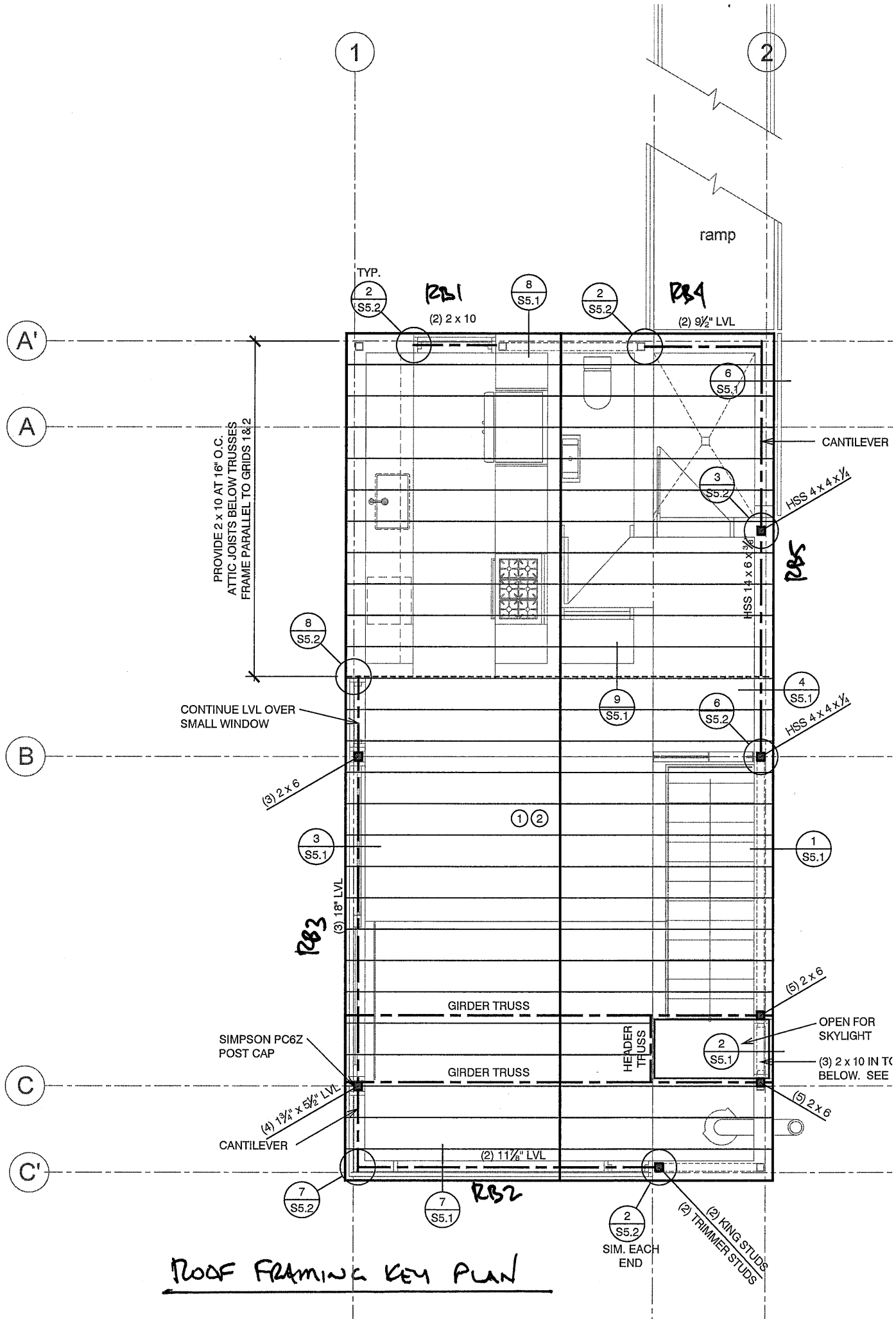

ROOF FRAMING KEY PLAN

SIMPLE BEAM - CONCENTRATED, AND UNIFORM LOAD

ROOF FRAMING
RB1

Length:	$l := 3.5 \cdot \text{ft}$	$a := 0 \cdot \text{ft}$	(larger)
Concentrated load:	$p := 0 \cdot \text{lb}$	$c := 1 - a$	
Weight per lineal foot:	$w := (192 + 15) \cdot 1 \cdot \text{plf}$		
Material:	$i := \text{DF2}$		
Allowable bending stress F_b :	$F_{b_i} = 900 \cdot \text{psi}$	Allowable shear stress F_v :	$F_{v_i} = 180 \cdot \text{psi}$
Modulus of elasticity E :	$E_i = 1600000 \cdot \text{psi}$		
C_d = load duration factor:	$C_d := 1.0$		
C_r = repetitive use factor:	$C_r := 1.0$		
Calculate bending moment:	$M := \frac{p \cdot a \cdot c}{1} + \left(w \cdot \frac{l^2}{8} \right)$	$M = 317 \cdot \text{ft} \cdot \text{lb}$	
Calculate the shear:	$V := \frac{p \cdot a}{1} + \left(w \cdot \frac{l}{2} \right)$	$V = 362.3 \cdot \text{lb}$	
Use: (2) 2 X 10	$b := 3.0 \cdot \text{in}$	$d := 9.25 \cdot \text{in}$	$t := \text{if}(d \leq 12 \cdot \text{in}, 12 \cdot \text{in}, d)$
C_F = Size factor (sawn lumber only)	$C_{F_i} := \text{if}(d > 4 \cdot \text{in}, \text{if}(d > 6 \cdot \text{in}, \text{if}(d > 8 \cdot \text{in}, 1.1, 1.2), 1.3), 1.5)$	$C_1 := \text{if}(d > 10 \cdot \text{in}, \text{if}(d > 12 \cdot \text{in}, 0.9, 1.0), C_2 := C_1$	$C_1 = 1.1$
C_v = volume factor (glu-laminated lumber only)	$C_3 := 1 \cdot \left(21 \cdot \frac{\text{ft}}{1} \right)^{-1} \cdot \left(12 \cdot \frac{\text{in}}{d} \right)^{-1} \cdot \left(5.125 \cdot \frac{\text{in}}{b} \right)^{-1}$	$C_3 := \text{if}(C_3 > 1, 1, C_3)$	$C_3 = 1$
C_F = LSL size factor:	$C_4 := \left(\frac{12 \cdot \text{in}}{t} \right)^{0.092}$	$C_4 = 1$	C_F = LVL size factor: $C_5 := \left(\frac{12 \cdot \text{in}}{t} \right)^{0.136}$
C_F = PSL size factor:	$C_6 := \left(\frac{12 \cdot \text{in}}{t} \right)^{0.111}$	$C_6 = 1$	$C_8 := C_1$ $C_9 := C_1$
Required section modulus:	$S := \frac{M}{F_{b_i} \cdot C_d \cdot C_r \cdot C_i}$	$S = 3.8 \cdot \text{in}^3$	
Actual section modulus:	$S := \frac{b}{6} \cdot d^2$	$S = 42.8 \cdot \text{in}^3$	
Required area:	$A := 1.5 \cdot \left(\frac{V - w \cdot d}{F_{v_i}} \right)$	$A = 1.7 \cdot \text{in}^2$	
Actual area:	$A := b \cdot d$	$A = 27.7 \cdot \text{in}^2$	
Check deflection:	$I := \frac{b}{12} \cdot d^3$	$I = 197.9 \cdot \text{in}^4$	
Allowable deflection:		$\frac{1}{240} = 0.175 \cdot \text{in}$	
Actual deflection:	$y := \frac{p \cdot a^2 \cdot c^2}{3 \cdot E_i \cdot I} + \frac{5 \cdot w \cdot l^4}{384 \cdot E_i \cdot I}$	$y = 2.208 \times 10^{-3} \cdot \text{in}$	

SIMPLE BEAM - CONCENTRATED, AND UNIFORM LOAD

ROOF FRAMING
RB2

Length:	$l := 13\text{-ft}$	$a := 0\text{-ft}$	(larger)
Concentrated load:	$p := 0\text{-lb}$	$c := 1 - a$	
Weight per lineal foot:	$w := (192 + 15)1\text{-plf}$		
Material:	$i := \text{LVL}$		
Allowable bending stress Fb:	$Fb_i = 2600\text{-psi}$	Allowable shear stress Fv:	$Fv_i = 285\text{-psi}$
Modulus of elasticity E:	$E_i = 2000000\text{-psi}$		
Cd = load duration factor:	$Cd := 1.0$		
Cr = repetitive use factor:	$Cr := 1.0$		
Calculate bending moment:	$M := \frac{p \cdot a \cdot c}{1} + \left(w \cdot \frac{l^2}{8} \right)$	$M = 4372.9\text{-ft}\cdot\text{lb}$	
Calculate the shear:	$V_w := \frac{p \cdot a}{1} + \left(w \cdot \frac{1}{2} \right)$	$V = 1345.5\text{-lb}$	
Use: (2) 1 3/4 X 11 7/8 LVL	$b := 3.5\text{-in}$	$d := 11.875\text{-in}$	$t := \text{if}(d \leq 12\text{-in}, 12\text{-in}, d)$
CF = Size factor (sawn lumber only)	$C_{w1} := \text{if}(d > 4\text{-in}, \text{if}(d > 6\text{-in}, \text{if}(d > 8\text{-in}, 1.1, 1.2), 1.3), 1.5)$	$C_1 := \text{if}(d > 10\text{-in}, \text{if}(d > 12\text{-in}, 0.9, 1.0), C_2 := C_1$	$C_1 = 1$
Cv = volume factor (glu-laminated lumber only)	$C_3 := 1 \cdot \left(21 \cdot \frac{\text{ft}}{1} \right)^{-1} \cdot \left(12 \cdot \frac{\text{in}}{d} \right)^{-1} \cdot \left(5.125 \cdot \frac{\text{in}}{b} \right)^{-1}$	$C_3 := \text{if}(C_3 > 1, 1, C_3)$	$C_3 = 1$
CF = LSL size factor:	$C_4 := \left(\frac{12\text{-in}}{t} \right)^{0.092}$	$C_4 = 1$	CF = LVL size factor: $C_5 := \left(\frac{12\text{-in}}{t} \right)^{0.136}$ $C_5 = 1$
CF = PSL size factor:	$C_6 := \left(\frac{12\text{-in}}{t} \right)^{0.111}$	$C_6 = 1$	$C_8 := C_1$ $C_9 := C_1$
Required section modulus:	$S_w := \frac{M}{Fb_i \cdot Cd \cdot Cr \cdot C_i}$	$S = 20.2\text{-in}^3$	
Actual section modulus:	$S_w := \frac{b \cdot d^2}{6}$	$S = 82.3\text{-in}^3$	
Required area:	$A_w := 1.5 \cdot \left(\frac{V - w \cdot d}{Fv_i} \right)$	$A = 6\text{-in}^2$	
Actual area:	$A_w := b \cdot d$	$A = 41.6\text{-in}^2$	
Check deflection:	$I := \frac{b}{12} \cdot d^3$	$I = 488.4\text{-in}^4$	
Allowable deflection:		$\frac{1}{240} = 0.65\text{-in}$	
Actual deflection:	$y := \frac{p \cdot a^2 \cdot c^2}{3 \cdot E_i \cdot I} + \frac{5 \cdot w \cdot l^4}{384 \cdot E_i \cdot I}$	$y = 0.136\text{-in}$	

BEAM OVERHANGING ONE SUPPORT - CONCENTRATED LOAD AT OVERHANG

ROOF FRAMING RB3

Simple length: $l := 14 \cdot \text{ft}$
 Cantilever length: $a := 4 \cdot \text{ft}$
 Uniform load: $w := (15 + 192) \cdot 9 \cdot \text{plf}$
 Point load at cantilever: $P := 1400 \cdot \text{lb}$
Material: $i := \text{LVL}$

$C_d =$ load duration factor: $C_d := 1.0$
 $C_r =$ repetitive use factor: $C_r := 1.0$

Allowable bending stress F_b : $F_{b_i} = 2600 \cdot \text{psi}$ Allowable shear stress F_v : $F_{v_i} = 285 \cdot \text{psi}$
 Modulus of elasticity E : $E_i = 2000000 \cdot \text{psi}$

Determine reactions: $R_1 := \frac{w}{2 \cdot l} \cdot (l^2 - a^2) - \frac{P \cdot a}{l}$ $R_1 = 11576.4 \cdot \text{lb}$

$$R_2 := \frac{w}{2 \cdot l} \cdot (l + a)^2 + \frac{P}{l} \cdot (l + a) \quad R_2 = 23357.6 \cdot \text{lb}$$

Determine shear forces: $V_1 := R_1$ $V_2 := w \cdot a + P$ $V_1 = 11576.4 \cdot \text{lb}$ $V_2 = 8852 \cdot \text{lb}$

$$V_3 := \frac{w}{2 \cdot l} \cdot (l^2 + a^2) + \frac{P \cdot a}{l} \quad V_3 = 14505.6 \cdot \text{lb}$$

Determine max locations: $x := \frac{1}{2} \cdot \left[1 - \left(\frac{a^2}{l^2} \right) \right]$ $x = 6.429 \cdot \text{ft}$

Determine moments: (between supports) $M_1 := \frac{w}{8 \cdot l^2} \cdot (l + a)^2 \cdot (l - a)^2 - \frac{P \cdot a \cdot x}{l}$ $M_1 = 35924.2 \cdot \text{ft} \cdot \text{lb}$

$$M_{\max} := |M_1|$$

(at cantilever end) $M_2 := \frac{w \cdot a^2}{2} + P \cdot a$ $M_2 = 20504 \cdot \text{ft} \cdot \text{lb}$

$$M := \text{if}(M_1 > M_2, M_1, M_2) \quad M = 35924.2 \cdot \text{ft} \cdot \text{lb}$$

$$V_{\max} := \text{if}(V_1 > V_2, \text{if}(V_1 > V_3, V_1, V_3), \text{if}(V_2 > V_3, V_2, V_3)) \quad V_{\max} = 14505.6 \cdot \text{lb}$$

Use: (3) 1 3/4 X 18 LVL

$$b := 5.25 \cdot \text{in}$$

$$d := 18 \cdot \text{in}$$

$$t := \text{if}(d \leq 12 \cdot \text{in}, 12 \cdot \text{in}, d)$$

CF = Size factor $C_{\max} := \text{if}(d > 4 \cdot \text{in}, \text{if}(d > 6 \cdot \text{in}, \text{if}(d > 8 \cdot \text{in}, 1.1, 1.2), 1.3), 1.5)$

(sawn lumber only)

$$C_1 := \text{if}(d > 10 \cdot \text{in}, \text{if}(d > 12 \cdot \text{in}, 0.9, 1.0), C_2 := C_1) \quad C_1 = 0.9$$

Cv = volume factor

(glu-laminated lumber only)

$$C_3 := 1 \cdot \left(21 \cdot \frac{\text{ft}}{l} \right)^1 \cdot \left(12 \cdot \frac{\text{in}}{d} \right)^1 \cdot \left(5.125 \cdot \frac{\text{in}}{b} \right)^1 \quad C_3 := \text{if}(C_3 > 1, 1, C_3) \quad C_3 = 0.998$$

CF = LSL size factor: $C_4 := \left(\frac{12 \cdot \text{in}}{t} \right)^{0.092}$ $C_4 = 0.963$ CF = LVL size factor: $C_5 := \left(\frac{12 \cdot \text{in}}{t} \right)^{0.136}$ $C_5 = 0.946$

CF = PSL size factor: $C_6 := \left(\frac{12 \cdot \text{in}}{t} \right)^{0.111}$ $C_6 = 0.956$ $C_8 := C_1$ $C_9 := C_1$

Required section modulus: $S_r := \frac{M}{(1 \cdot F_b)_i \cdot C_d \cdot C_r \cdot C_i}$

Actual section modulus: $S_a := b \cdot \frac{d^2}{6}$ $S_a = 283.5 \cdot \text{in}^3$ $>$ $S_r = 175.2 \cdot \text{in}^3$

Required area: $A_r := 1.5 \cdot \left(\frac{V - w \cdot d}{F_{v_i}} \right)$

Actual area: $A_a := b \cdot d$ $A_a = 94.5 \cdot \text{in}^2$ $>$ $A_r = 61.6 \cdot \text{in}^2$

Determine deflections: $I := b \cdot \frac{d^3}{12}$ $I = 2551.5 \cdot \text{in}^4$

$y := \frac{w \cdot x}{24 \cdot E_i \cdot I} \cdot (l^4 - 2 \cdot l^2 \cdot x^2 + l \cdot x^3 - 2 \cdot a^2 \cdot l^2 + 2 \cdot a^2 \cdot x^2)$ $y_c := 0.06415 \cdot \frac{P \cdot a \cdot l^2}{E_i \cdot I}$ $y_w := y - y_c$

(between supports)

$\frac{l}{240} = 0.7 \cdot \text{in}$ $>$ $y = 0.229 \cdot \text{in}$

$y_1 := \frac{w \cdot a}{24 \cdot E_i \cdot I} \cdot (3 \cdot a^3 - 4 \cdot a^2 \cdot l - l^3)$ $y_{1c} := \frac{P \cdot a^2}{3 \cdot E_i \cdot I} \cdot (l + a)$ $y_{1w} := y_1 + y_{1c}$

(at end of cantilever)

$\frac{2 \cdot a}{240} = 0.4 \cdot \text{in}$ $>$ $y_1 = -0.317 \cdot \text{in}$

SIMPLE BEAM - CONCENTRATED, AND UNIFORM LOAD

ROOF FRAMING
RB4

Length:	$l := 6 \cdot \text{ft}$	$a := 0 \cdot \text{ft}$ (larger)	
Concentrated load:	$p := 0 \cdot \text{lb}$	$c := 1 - a$	
Weight per lineal foot:	$w := (192 + 15) \cdot 1 \cdot \text{plf}$		
Material:	$i := \text{LVL}$		
Allowable bending stress Fb:	$Fb_i = 2600 \cdot \text{psi}$	Allowable shear stress Fv:	$Fv_i = 285 \cdot \text{psi}$
Modulus of elasticity E:	$E_i = 2000000 \cdot \text{psi}$		
Cd = load duration factor:	$Cd := 1.0$		
Cr = repetitive use factor:	$Cr := 1.0$		
Calculate bending moment:	$M := \frac{p \cdot a \cdot c}{1} + \left(w \cdot \frac{l^2}{8} \right)$	$M = 931.5 \cdot \text{ft} \cdot \text{lb}$	
Calculate the shear:	$V_w := \frac{p \cdot a}{1} + \left(w \cdot \frac{1}{2} \right)$	$V = 621 \cdot \text{lb}$	
Use: (2) 1 3/4 X 9 1/2 LVL	$b := 3.5 \cdot \text{in}$	$d := 9.5 \cdot \text{in}$	$t := \text{if}(d \leq 12 \cdot \text{in}, 12 \cdot \text{in}, d)$
CF = Size factor (sawn lumber only)	$C_{1w} := \text{if}(d > 4 \cdot \text{in}, \text{if}(d > 6 \cdot \text{in}, \text{if}(d > 8 \cdot \text{in}, 1.1, 1.2), 1.3), 1.5)$		
	$C_1 := \text{if}(d > 10 \cdot \text{in}, \text{if}(d > 12 \cdot \text{in}, 0.9, 1.0), (C_2 := C_1$	$C_1 = 1.1$	
Cv = volume factor (glu-laminated lumber only)	$C_3 := 1 \cdot \left(21 \cdot \frac{\text{ft}}{1} \right)^{-1} \cdot \left(12 \cdot \frac{\text{in}}{d} \right)^{-1} \cdot \left(5.125 \cdot \frac{\text{in}}{b} \right)^{-1}$	$C_3 := \text{if}(C_3 > 1, 1, C_3)$	$C_3 = 1$
CF = LSL size factor:	$C_4 := \left(\frac{12 \cdot \text{in}}{t} \right)^{0.092}$	$C_4 = 1$	CF = LVL size factor: $C_5 := \left(\frac{12 \cdot \text{in}}{t} \right)^{0.136}$ $C_5 = 1$
CF = PSL size factor:	$C_6 := \left(\frac{12 \cdot \text{in}}{t} \right)^{0.111}$	$C_6 = 1$	$C_8 := C_1$ $C_9 := C_1$
Required section modulus:	$S_w := \frac{M}{Fb_i \cdot Cd \cdot Cr \cdot C_i}$	$S = 4.3 \cdot \text{in}^3$	
Actual section modulus:	$S_w := \frac{b}{6} \cdot d^2$	$S = 52.6 \cdot \text{in}^3$	
Required area:	$A_w := 1.5 \cdot \left(\frac{V - w \cdot d}{Fv_i} \right)$	$A = 2.4 \cdot \text{in}^2$	
Actual area:	$A_w := b \cdot d$	$A = 33.2 \cdot \text{in}^2$	
Check deflection:	$I := \frac{b}{12} \cdot d^3$	$I = 250.1 \cdot \text{in}^4$	
Allowable deflection:		$\frac{1}{240} = 0.3 \cdot \text{in}$	
Actual deflection:	$y := \frac{p \cdot a^2 \cdot c^2}{3 \cdot E_i \cdot I} + \frac{5 \cdot w \cdot l^4}{384 \cdot E_i \cdot I}$	$y = 0.012 \cdot \text{in}$	



RAM SBeam v5.01
Powder Mountain 1000
RB5

Gravity Beam Design

07/21/17 11:41:31

STEEL CODE: AISC 360-05 LRFD

SPAN INFORMATION (ft): I-End (0.00,0.00) J-End (20.00,0.00)

Maximum Depth Limitation specified = 15.00 in

Beam Size (User Selected) = HSS14X6X3/8 Fy = 46.0 ksi

Total Beam Length (ft) = 20.00

Cantilever on right (ft) = 8.00

Mp (kip-ft) = 219.65

Top flange braced by decking.

LINE LOADS (k/ft):

Load	Dist (ft)	DL	LL
1	0.000	0.045	0.000
	12.000	0.045	0.000
2	0.000	0.140	1.800
	12.000	0.140	1.800
3	12.000	0.045	0.000
	20.000	0.045	0.000
4	12.000	0.140	1.800
	20.000	0.140	1.800

SHEAR (Ultimate): Max Vu (1.2DL+1.6LL) = 26.88 kips 0.90Vn = 242.74 kips

MOMENTS (Ultimate):

Span	Cond	LoadCombo	Mu kip-ft	@ ft	Lb ft	Cb	Phi	Phi*Mn kip-ft
Center	Max +	1.2DL+1.6LL	52.3	5.8	0.0	1.00	0.90	197.68
	Max -	1.2DL+1.6LL	-99.3	12.0	12.0	1.75	0.90	197.68
Right	Max -	1.2DL+1.6LL	-99.3	12.0	8.0	1.00	0.90	197.68
Controlling		1.2DL+1.6LL	-99.3	12.0	12.0	1.75	0.90	197.68

REACTIONS (kips):

	Left	Right
DL reaction	0.62	3.08
Max +LL reaction	10.80	30.00
Max -LL reaction	-4.80	0.00
Max +total reaction (factored)	18.02	51.70
Max -total reaction	-6.94	4.31

DEFLECTIONS:

Center span:

Dead load (in)	at	7.02 ft =	0.001	L/D = 118920
Live load (in)	at	7.02 ft =	0.100	L/D = 1440
Net Total load (in)	at	7.02 ft =	0.101	L/D = 1423

Right cantilever:

Dead load (in)	=	-0.033	L/D = 5754
Pos Live load (in)	=	-0.520	L/D = 369
Neg Live load (in)	=	0.195	L/D = 985
Pos Total load (in)	=	-0.553	L/D = 347



RAM SBeam v5.01
Powder Mountain 1000
RB5

Gravity Beam Design

Right cantilever:

Neg Total load (in) = 0.162 L/D = 1189

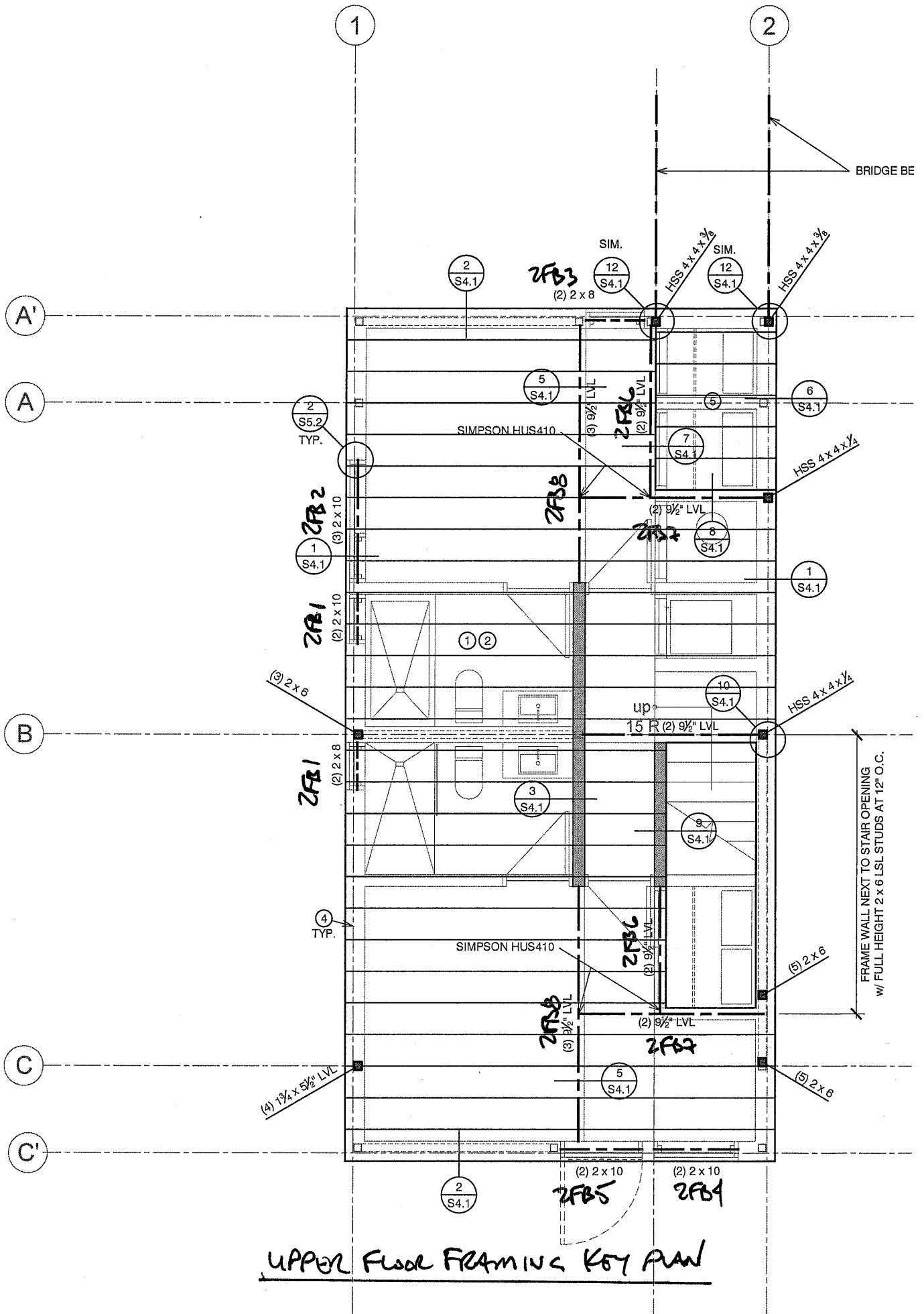

UPPER FLOOR FRAMING KEY PLAN

SIMPLE BEAM - CONCENTRATED, AND UNIFORM LOAD

UPPER FLOOR FRAMING FLOOR JOISTS

Span Length:	$l_w := 10 \cdot \text{ft}$	
Spacing:	$s_w := 16 \cdot \text{in}$	
Loads per lineal foot:	$wll := 40 \cdot \text{psf} \cdot s$	
	$wdl := 50 \cdot \text{psf} \cdot s$	$w := wdl + wll$
Concentrated loads:	$pll := 0 \cdot \text{lb}$	$pdl := 0 \cdot \text{lb}$
Location of point load:	$a := 0 \cdot \text{ft}$	$c_w := 1 - a$ (use larger distance for a)
	$p := pll + pdl$	

Calculate the bending moment:

$$M_x := \frac{p \cdot a \cdot c}{1} + \left(w \cdot \frac{l^2}{8} \right)$$

$M_x = 1500 \cdot \text{ft} \cdot \text{lb}$

Calculate the shear:

$$V_x := \frac{p \cdot a}{1} + \left(w \cdot \frac{1}{2} \right)$$

$V_x = 600 \cdot \text{lb}$

Reference: \\SERVER\Jobs\Calculation Templates\Reference Tables\I-Joist Values 2013.xmcd

Joist Series:	Series := 210	$j := \text{if}(\text{Series} > 110, \text{if}(\text{Series} > 210, \text{if}(\text{Series} > 360, 4, 3), 2), 1)$
Joist Depth:	d := 9.5 in	$i := \text{if}(d > 9.5 \cdot \text{in}, \text{if}(d > 11.875 \cdot \text{in}, \text{if}(d > 14 \cdot \text{in}, 4, 3), 2), 1)$

USE: 9 1/2" TJI 210 @ 16" O.C.

	Joist Capacities	>	Required Capacities
Moment Capacity:	$M_{i,j} = 3000 \cdot \text{ft} \cdot \text{lb}$	>	$M_x = 1500 \cdot \text{ft} \cdot \text{lb}$
Maximum Reaction:	$V_{i,j} = 1330 \cdot \text{lb}$	>	$V_x = 600 \cdot \text{lb}$
Deflection Constant:	$EI_{i,j} = 186 \cdot 10^6 \cdot \text{in}^2 \cdot \text{lb}$		

Check deflection:

Total deflection:

$$y := \frac{p \cdot a^2 \cdot c^2}{3 \cdot EI_{i,j} \cdot l} + \frac{5 \cdot w \cdot l^4}{384 \cdot EI_{i,j}} + \frac{2.67 \cdot w \cdot l^2}{d \cdot 10^5} \cdot \frac{\text{in}}{\text{lb} \cdot 12}$$

Compare total deflection with allowable:

$$\frac{1}{240} = 0.5 \cdot \text{in} > y = 0.179 \cdot \text{in}$$

Live Load deflection:

$$w_w := \frac{pll \cdot a^2 \cdot c^2}{3 \cdot EI_{i,j} \cdot l} + \frac{5 \cdot wll \cdot l^4}{384 \cdot EI_{i,j}} + \frac{2.67 \cdot wll \cdot l^2}{d \cdot 10^5} \cdot \frac{\text{in}}{\text{lb} \cdot 12}$$

Compare Live Load deflection with allowable:

$$\frac{1}{480} = 0.25 \cdot \text{in} > y = 0.08 \cdot \text{in}$$

SIMPLE BEAM - CONCENTRATED, AND UNIFORM LOAD

SECOND FLOOR FRAMING
JOISTS AT ENTRY

Length:	$l := 5\text{-ft}$	$a := 0\text{-ft}$	(larger)
Concentrated load:	$p := 0\text{-lb}$	$e_a := 1 - a$	
Weight per lineal foot:	$w := (50 + 40)1.33\text{-plf}$		
Material:	$i := \text{DF2}$		
Allowable bending stress F_b :	$F_b := 900\text{-psi}$	Allowable shear stress F_v :	$F_v := 180\text{-psi}$
Modulus of elasticity E :	$E_i := 1600000\text{-psi}$		
C_d = load duration factor:	$C_d := 1.0$		
C_r = repetitive use factor:	$C_r := 1.0$		
Calculate bending moment:	$M := \frac{p \cdot a \cdot c}{1} + \left(w \cdot \frac{l^2}{8} \right)$	$M = 374.1\text{-ft}\cdot\text{lb}$	
Calculate the shear:	$V := \frac{p \cdot a}{1} + \left(w \cdot \frac{1}{2} \right)$	$V = 299.2\text{-lb}$	
Use: 2 X 8 AT 16" O.C.	$b := 1.5\text{-in}$	$d := 7.25\text{-in}$	$t := \text{if}(d \leq 12\text{-in}, 12\text{-in}, d)$
C_F = Size factor (sawn lumber only)	$C_{F1} := \text{if}(d > 4\text{-in}, \text{if}(d > 6\text{-in}, \text{if}(d > 8\text{-in}, 1.1, 1.2), 1.3), 1.5)$		
	$C_1 := \text{if}(d > 10\text{-in}, \text{if}(d > 12\text{-in}, 0.9, 1.0), C_2 := C_1$	$C_1 = 1.2$	
C_v = volume factor (glu-laminated lumber only)	$C_3 := 1 \cdot \left(21 \cdot \frac{\text{ft}}{1} \right)^{-1} \cdot \left(12 \cdot \frac{\text{in}}{d} \right)^{-1} \cdot \left(5.125 \cdot \frac{\text{in}}{b} \right)^{-1}$		
	$C_3 := \text{if}(C_3 > 1, 1, C_3)$ $C_3 = 1$		
C_F = LSL size factor:	$C_4 := \left(\frac{12\text{-in}}{t} \right)^{0.092}$	$C_4 = 1$	C_F = LVL size factor: $C_5 := \left(\frac{12\text{-in}}{t} \right)^{0.136}$ $C_5 = 1$
C_F = PSL size factor:	$C_6 := \left(\frac{12\text{-in}}{t} \right)^{0.111}$	$C_6 = 1$	$C_8 := C_1$ $C_9 := C_1$
Required section modulus:	$S_{ww} := \frac{M}{F_b \cdot C_d \cdot C_r \cdot C_i}$	$S = 4.2\text{-in}^3$	
Actual section modulus:	$S_{ww} := \frac{b \cdot d^2}{6}$	$S = 13.1\text{-in}^3$	
Required area:	$A_{ww} := 1.5 \cdot \left(\frac{V - w \cdot d}{F_v} \right)$	$A = 1.9\text{-in}^2$	
Actual area:	$A_{ww} := b \cdot d$	$A = 10.9\text{-in}^2$	
Check deflection:	$I := \frac{b \cdot d^3}{12}$	$I = 47.6\text{-in}^4$	
Allowable deflection:		$\frac{l}{240} = 0.25\text{-in}$	$\frac{l}{360} = 0.167\text{-in}$
Actual deflection:	$y := \frac{p \cdot a^2 \cdot c^2}{3 \cdot E_i \cdot I} + \frac{5 \cdot w \cdot l^4}{384 \cdot E_i \cdot I}$	$y = 0.022\text{-in}$	$y \cdot \frac{40}{90} = 0.01\text{-in}$

SIMPLE BEAM - CONCENTRATED, AND UNIFORM LOAD

SECOND FLOOR FRAMING
2FB1

Length:	$l := 2\text{-ft}$	$a := 0\text{-ft}$	(larger)
Concentrated load:	$p := 0\text{-lb}$	$c := 1 - a$	
Weight per lineal foot:	$w := (50 + 40)5\text{-plf} + (15 + 192)9\text{-plf}$		
Material:	$i := \text{DF2}$		
Allowable bending stress F_b :	$F_b := 900\text{-psi}$	Allowable shear stress F_v :	$F_v := 180\text{-psi}$
Modulus of elasticity E :	$E_i := 1600000\text{-psi}$		
C_d = load duration factor:	$C_d := 1.0$		
C_r = repetitive use factor:	$C_r := 1.0$		
Calculate bending moment:	$M := \frac{p \cdot a \cdot c}{1} + \left(w \cdot \frac{l^2}{8} \right)$	$M = 1156.5\text{-ft}\cdot\text{lb}$	
Calculate the shear:	$V := \frac{p \cdot a}{1} + \left(w \cdot \frac{1}{2} \right)$	$V = 2313\text{-lb}$	
Use: (2) 2 X 8	$b := 3.0\text{-in}$	$d := 7.25\text{-in}$	$t := \text{if}(d \leq 12\text{-in}, 12\text{-in}, d)$
CF = Size factor (sawn lumber only)	$C_{1i} := \text{if}(d > 4\text{-in}, \text{if}(d > 6\text{-in}, \text{if}(d > 8\text{-in}, 1.1, 1.2), 1.3), 1.5)$		
	$C_1 := \text{if}(d > 10\text{-in}, \text{if}(d > 12\text{-in}, 0.9, 1.0), C_2 := C_1$	$C_1 = 1.2$	
C_v = volume factor (glu-laminated lumber only)	$C_3 := 1 \cdot \left(21 \cdot \frac{\text{ft}}{1} \right)^{-1} \cdot \left(12 \cdot \frac{\text{in}}{d} \right)^{-1} \cdot \left(5.125 \cdot \frac{\text{in}}{b} \right)^{-1}$		
	$C_3 := \text{if}(C_3 > 1, 1, C_3)$	$C_3 = 1$	
CF = LSL size factor:	$C_4 := \left(\frac{12\text{-in}}{t} \right)^{0.092}$	$C_4 = 1$	CF = LVL size factor: $C_5 := \left(\frac{12\text{-in}}{t} \right)^{0.136}$ $C_5 = 1$
CF = PSL size factor:	$C_6 := \left(\frac{12\text{-in}}{t} \right)^{0.111}$	$C_6 = 1$	$C_8 := C_1$ $C_9 := C_1$
Required section modulus:	$S_{ww} := \frac{M}{F_b \cdot C_d \cdot C_r \cdot C_i}$	$S = 12.9\text{-in}^3$	
Actual section modulus:	$S_{ww} := \frac{b}{6} \cdot d^2$	$S = 26.3\text{-in}^3$	
Required area:	$A_{ww} := 1.5 \cdot \left(\frac{V - w \cdot d}{F_v} \right)$	$A = 7.6\text{-in}^2$	
Actual area:	$A_{ww} := b \cdot d$	$A = 21.7\text{-in}^2$	
Check deflection:	$I := \frac{b}{12} \cdot d^3$	$I = 95.3\text{-in}^4$	
Allowable deflection:		$\frac{1}{240} = 0.1\text{-in}$	$\frac{1}{360} = 0.067\text{-in}$
Actual deflection:	$y := \frac{p \cdot a^2 \cdot c^2}{3 \cdot E_i \cdot I} + \frac{5 \cdot w \cdot l^4}{384 \cdot E_i \cdot I}$	$y = 0.005\text{-in}$	$y \cdot \frac{40}{90} = 0.002\text{-in}$

SIMPLE BEAM - CONCENTRATED, AND UNIFORM LOAD

SECOND FLOOR FRAMING
2FB2

Length:	$l := 5 \cdot \text{ft}$	$a := 0 \cdot \text{ft}$	(larger)
Concentrated load:	$p := 0 \cdot \text{lb}$	$\alpha := 1 - a$	
Weight per lineal foot:	$w := (50 + 40)5 \cdot \text{plf} + (15 + 192) \cdot 9 \cdot \text{plf}$		
Material:	$i := \text{LVL}$		
Allowable bending stress Fb:	$Fb_i = 2600 \cdot \text{psi}$	Allowable shear stress Fv:	$Fv_i = 285 \cdot \text{psi}$
Modulus of elasticity E:	$E_i = 2000000 \cdot \text{psi}$		
Cd = load duration factor:	$Cd := 1.0$		
Cr = repetitive use factor:	$Cr := 1.0$		
Calculate bending moment:	$M := \frac{p \cdot a \cdot c}{1} + \left(w \cdot \frac{l^2}{8} \right)$	$M = 7228.1 \cdot \text{ft} \cdot \text{lb}$	
Calculate the shear:	$V_{\text{max}} := \frac{p \cdot a}{1} + \left(w \cdot \frac{1}{2} \right)$	$V = 5782.5 \cdot \text{lb}$	
Use: (3) 2 X 10	$b := 4.5 \cdot \text{in}$	$d := 9.25 \cdot \text{in}$	$t := \text{if}(d \leq 12 \cdot \text{in}, 12 \cdot \text{in}, d)$
CF = Size factor (sawn lumber only)	$C_{1i} := \text{if}(d > 4 \cdot \text{in}, \text{if}(d > 6 \cdot \text{in}, \text{if}(d > 8 \cdot \text{in}, 1.1, 1.2), 1.3), 1.5)$		
	$C_1 := \text{if}(d > 10 \cdot \text{in}, \text{if}(d > 12 \cdot \text{in}, 0.9, 1.0), C_2 := C_1$	$C_1 = 1.1$	
Cv = volume factor (glu-laminated lumber only)	$C_3 := 1 \cdot \left(21 \cdot \frac{\text{ft}}{1} \right)^{-1} \cdot \left(12 \cdot \frac{\text{in}}{d} \right)^{-1} \cdot \left(5.125 \cdot \frac{\text{in}}{b} \right)^{-1}$		
	$C_3 := \text{if}(C_3 > 1, 1, C_3) \quad C_3 = 1$		
CF = LSL size factor:	$C_4 := \left(\frac{12 \cdot \text{in}}{t} \right)^{0.092}$	$C_4 = 1$	CF = LVL size factor: $C_5 := \left(\frac{12 \cdot \text{in}}{t} \right)^{0.136}$
			$C_5 = 1$
CF = PSL size factor:	$C_6 := \left(\frac{12 \cdot \text{in}}{t} \right)^{0.111}$	$C_6 = 1$	$C_8 := C_1 \quad C_9 := C_1$
Required section modulus:	$S_{\text{req}} := \frac{M}{Fb_i \cdot Cd \cdot Cr \cdot C_i}$	$S = 33.4 \cdot \text{in}^3$	
Actual section modulus:	$S_{\text{act}} := \frac{b}{6} \cdot d^2$	$S = 64.2 \cdot \text{in}^3$	
Required area:	$A_{\text{req}} := 1.5 \cdot \left(\frac{V - w \cdot d}{Fv_i} \right)$	$A = 21.1 \cdot \text{in}^2$	
Actual area:	$A_{\text{act}} := b \cdot d$	$A = 41.6 \cdot \text{in}^2$	
Check deflection:	$I := \frac{b}{12} \cdot d^3$	$I = 296.8 \cdot \text{in}^4$	
Allowable deflection:		$\frac{l}{240} = 0.25 \cdot \text{in}$	$\frac{l}{360} = 0.167 \cdot \text{in}$
Actual deflection:	$y := \frac{p \cdot a^2 \cdot c^2}{3 \cdot E_i \cdot I} + \frac{5 \cdot w \cdot l^4}{384 \cdot E_i \cdot I}$	$y = 0.055 \cdot \text{in}$	$y \cdot \frac{40}{90} = 0.024 \cdot \text{in}$

SIMPLE BEAM - CONCENTRATED, AND UNIFORM LOAD

SECOND FLOOR FRAMING
2FB3

Length:	$l := 2 \cdot \text{ft}$	$a := 0 \cdot \text{ft}$	(larger)
Concentrated load:	$p := 0 \cdot \text{lb}$	$\alpha := 1 - a$	
Weight per lineal foot:	$w := (50 + 40)1 \cdot \text{plf} + (15 + 192) \cdot 1 \cdot \text{plf}$		
Material:	$i := \text{DF2}$		
Allowable bending stress F_b :	$F_{b_i} = 900 \cdot \text{psi}$	Allowable shear stress F_v :	$F_{v_i} = 180 \cdot \text{psi}$
Modulus of elasticity E :	$E_i = 1600000 \cdot \text{psi}$		
C_d = load duration factor:	$C_d := 1.0$		
C_r = repetitive use factor:	$C_r := 1.0$		
Calculate bending moment:	$M := \frac{p \cdot a \cdot c}{1} + \left(w \cdot \frac{l^2}{8} \right)$	$M = 148.5 \cdot \text{ft} \cdot \text{lb}$	
Calculate the shear:	$V_{\text{max}} := \frac{p \cdot a}{1} + \left(w \cdot \frac{1}{2} \right)$	$V = 297 \cdot \text{lb}$	
Use: (2) 2 X 8	$b := 3.0 \cdot \text{in}$	$d := 7.25 \cdot \text{in}$	$t := \text{if}(d \leq 12 \cdot \text{in}, 12 \cdot \text{in}, d)$
CF = Size factor (sawn lumber only)	$C_{1_i} := \text{if}(d > 4 \cdot \text{in}, \text{if}(d > 6 \cdot \text{in}, \text{if}(d > 8 \cdot \text{in}, 1.1, 1.2), 1.3), 1.5)$		
	$C_1 := \text{if}(d > 10 \cdot \text{in}, \text{if}(d > 12 \cdot \text{in}, 0.9, 1.0), C_2 := C_1$	$C_1 = 1.2$	
C_v = volume factor (glu-laminated lumber only)	$C_3 := 1 \cdot \left(21 \cdot \frac{\text{ft}}{1} \right)^{.1} \cdot \left(12 \cdot \frac{\text{in}}{d} \right)^{.1} \cdot \left(5.125 \cdot \frac{\text{in}}{b} \right)^{.1}$		
	$C_3 := \text{if}(C_3 > 1, 1, C_3)$	$C_3 = 1$	
CF = LSL size factor:	$C_4 := \left(\frac{12 \cdot \text{in}}{t} \right)^{0.092}$	$C_4 = 1$	CF = LVL size factor: $C_5 := \left(\frac{12 \cdot \text{in}}{t} \right)^{0.136}$ $C_5 = 1$
CF = PSL size factor:	$C_6 := \left(\frac{12 \cdot \text{in}}{t} \right)^{0.111}$	$C_6 = 1$	$C_8 := C_1$ $C_9 := C_1$
Required section modulus:	$S_{\text{req}} := \frac{M}{F_{b_i} \cdot C_d \cdot C_r \cdot C_1}$	$S = 1.7 \cdot \text{in}^3$	
Actual section modulus:	$S_{\text{act}} := \frac{b}{6} \cdot d^2$	$S = 26.3 \cdot \text{in}^3$	
Required area:	$A_{\text{req}} := 1.5 \cdot \left(\frac{V - w \cdot d}{F_{v_i}} \right)$	$A = 1 \cdot \text{in}^2$	
Actual area:	$A_{\text{act}} := b \cdot d$	$A = 21.7 \cdot \text{in}^2$	
Check deflection:	$I := \frac{b}{12} \cdot d^3$	$I = 95.3 \cdot \text{in}^4$	
Allowable deflection:		$\frac{1}{240} = 0.1 \cdot \text{in}$	$\frac{1}{360} = 0.067 \cdot \text{in}$
Actual deflection:	$y := \frac{p \cdot a^2 \cdot c^2}{3 \cdot E_i \cdot I} + \frac{5 \cdot w \cdot l^4}{384 \cdot E_i \cdot I}$	$y = 0.001 \cdot \text{in}$	$y \cdot \frac{40}{90} = 0 \cdot \text{in}$

SIMPLE BEAM - CONCENTRATED, AND UNIFORM LOAD**SECOND FLOOR FRAMING
2FB4**

Length:	$l := 3.5 \cdot \text{ft}$	$a := 0 \cdot \text{ft}$	(larger)
Concentrated load:	$p := 0 \cdot \text{lb}$	$c := 1 - a$	
Weight per lineal foot:	$w := (50 + 40)1 \cdot \text{plf} + (15 + 192) \cdot 1 \cdot \text{plf}$		
Material:	$i := \text{DF2}$		
Allowable bending stress Fb:	$Fb_i = 900 \cdot \text{psi}$	Allowable shear stress Fv:	$Fv_i = 180 \cdot \text{psi}$
Modulus of elasticity E:	$E_i = 1600000 \cdot \text{psi}$		
Cd = load duration factor:	$Cd := 1.0$		
Cr = repetitive use factor:	$Cr := 1.0$		
Calculate bending moment:	$M := \frac{p \cdot a \cdot c}{1} + \left(w \cdot \frac{l^2}{8} \right)$	$M = 454.8 \cdot \text{ft} \cdot \text{lb}$	
Calculate the shear:	$V := \frac{p \cdot a}{1} + \left(w \cdot \frac{1}{2} \right)$	$V = 519.7 \cdot \text{lb}$	
Use: (2) 2 X 10	$b := 3.0 \cdot \text{in}$	$d := 9.25 \cdot \text{in}$	$t := \text{if}(d \leq 12 \cdot \text{in}, 12 \cdot \text{in}, d)$
CF = Size factor (sawn lumber only)	$C_{1i} := \text{if}(d > 4 \cdot \text{in}, \text{if}(d > 6 \cdot \text{in}, \text{if}(d > 8 \cdot \text{in}, 1.1, 1.2), 1.3), 1.5)$		
	$C_1 := \text{if}(d > 10 \cdot \text{in}, \text{if}(d > 12 \cdot \text{in}, 0.9, 1.0), C_2 := C_1$	$C_1 = 1.1$	
Cv = volume factor (glu-laminated lumber only)	$C_3 := 1 \cdot \left(21 \cdot \frac{\text{ft}}{1} \right)^{-1} \cdot \left(12 \cdot \frac{\text{in}}{d} \right)^{-1} \cdot \left(5.125 \cdot \frac{\text{in}}{b} \right)^{-1}$		
	$C_3 := \text{if}(C_3 > 1, 1, C_3)$	$C_3 = 1$	
CF = LSL size factor:	$C_4 := \left(\frac{12 \cdot \text{in}}{t} \right)^{0.092}$	$C_4 = 1$	CF = LVL size factor: $C_5 := \left(\frac{12 \cdot \text{in}}{t} \right)^{0.136}$ $C_5 = 1$
CF = PSL size factor:	$C_6 := \left(\frac{12 \cdot \text{in}}{t} \right)^{0.111}$	$C_6 = 1$	$C_8 := C_1$ $C_9 := C_1$
Required section modulus:	$S_{ww} := \frac{M}{Fb_i \cdot Cd \cdot Cr \cdot C_i}$	$S = 5.5 \cdot \text{in}^3$	
Actual section modulus:	$S_{ww} := \frac{b \cdot d^2}{6}$	$S = 42.8 \cdot \text{in}^3$	
Required area:	$A_{ww} := 1.5 \cdot \left(\frac{V - w \cdot d}{Fv_i} \right)$	$A = 2.4 \cdot \text{in}^2$	
Actual area:	$A_{ww} := b \cdot d$	$A = 27.7 \cdot \text{in}^2$	
Check deflection:	$I := \frac{b \cdot d^3}{12}$	$I = 197.9 \cdot \text{in}^4$	
Allowable deflection:		$\frac{1}{240} = 0.175 \cdot \text{in}$	$\frac{1}{360} = 0.117 \cdot \text{in}$
Actual deflection:	$y := \frac{p \cdot a^2 \cdot c^2}{3 \cdot E_i \cdot I} + \frac{5 \cdot w \cdot l^4}{384 \cdot E_i \cdot I}$	$y = 0.003 \cdot \text{in}$	$y \cdot \frac{40}{90} = 0.001 \cdot \text{in}$

SIMPLE BEAM - CONCENTRATED, AND UNIFORM LOAD

SECOND FLOOR FRAMING
2FB5

Length:	$l := 3.5 \cdot \text{ft}$	$a := 3 \cdot \text{ft}$ (larger)	
Concentrated load:	$p := 4500 \cdot \text{lb}$	$c := 1 - a$	
Weight per lineal foot:	$w := (50 + 40)1 \cdot \text{plf} + (15 + 192) \cdot 1 \cdot \text{plf}$		
Material:	$i := \text{DF2}$		
Allowable bending stress F_b :	$F_{b_i} = 900 \cdot \text{psi}$	Allowable shear stress F_v :	$F_{v_i} = 180 \cdot \text{psi}$
Modulus of elasticity E :	$E_i = 1600000 \cdot \text{psi}$		
C_d = load duration factor:	$C_d := 1.0$		
C_r = repetitive use factor:	$C_r := 1.0$		
Calculate bending moment:	$M := \frac{p \cdot a \cdot c}{1} + \left(w \cdot \frac{l^2}{8} \right)$	$M = 2383.4 \cdot \text{ft} \cdot \text{lb}$	
Calculate the shear:	$V_w := \frac{p \cdot a}{1} + \left(w \cdot \frac{l}{2} \right)$	$V = 4376.9 \cdot \text{lb}$	
Use: (3) 2 X 10	$b := 4.5 \cdot \text{in}$	$d := 9.25 \cdot \text{in}$	$t := \text{if}(d \leq 12 \cdot \text{in}, 12 \cdot \text{in}, d)$
CF = Size factor (sawn lumber only)	$C_{1_w} := \text{if}(d > 4 \cdot \text{in}, \text{if}(d > 6 \cdot \text{in}, \text{if}(d > 8 \cdot \text{in}, 1.1, 1.2), 1.3), 1.5)$		
	$C_1 := \text{if}(d > 10 \cdot \text{in}, \text{if}(d > 12 \cdot \text{in}, 0.9, 1.0), C_2 := C_1$	$C_1 = 1.1$	
C_v = volume factor (glu-laminated lumber only)	$C_3 := 1 \cdot \left(21 \cdot \frac{\text{ft}}{1} \right)^{-1} \cdot \left(12 \cdot \frac{\text{in}}{d} \right)^{-1} \cdot \left(5.125 \cdot \frac{\text{in}}{b} \right)^{-1}$		
	$C_3 := \text{if}(C_3 > 1, 1, C_3)$	$C_3 = 1$	
CF = LSL size factor:	$C_4 := \left(\frac{12 \cdot \text{in}}{t} \right)^{0.092}$	$C_4 = 1$	CF = LVL size factor: $C_5 := \left(\frac{12 \cdot \text{in}}{t} \right)^{0.136}$ $C_5 = 1$
CF = PSL size factor:	$C_6 := \left(\frac{12 \cdot \text{in}}{t} \right)^{0.111}$	$C_6 = 1$	$C_8 := C_1$ $C_9 := C_1$
Required section modulus:	$S_w := \frac{M}{F_{b_i} \cdot C_d \cdot C_r \cdot C_i}$	$S = 28.9 \cdot \text{in}^3$	
Actual section modulus:	$S_w := \frac{b}{6} \cdot d^2$	$S = 64.2 \cdot \text{in}^3$	
Required area:	$A_w := 1.5 \cdot \left(\frac{V - w \cdot d}{F_{v_i}} \right)$	$A = 34.6 \cdot \text{in}^2$	
Actual area:	$A_w := b \cdot d$	$A = 41.6 \cdot \text{in}^2$	
Check deflection:	$I := \frac{b}{12} \cdot d^3$	$I = 296.8 \cdot \text{in}^4$	
Allowable deflection:		$\frac{1}{240} = 0.175 \cdot \text{in}$	$\frac{1}{360} = 0.117 \cdot \text{in}$
Actual deflection:	$y := \frac{p \cdot a^2 \cdot c^2}{3 \cdot E_i \cdot I} + \frac{5 \cdot w \cdot l^4}{384 \cdot E_i \cdot I}$	$y = 0.006 \cdot \text{in}$	$y \cdot \frac{40}{90} = 0.002 \cdot \text{in}$

SIMPLE BEAM - CONCENTRATED, AND UNIFORM LOAD**SECOND FLOOR FRAMING
2FB6 (WORST CASE)**

Length:	$l := 8 \cdot \text{ft}$	$a := 0 \cdot \text{ft}$	(larger)
Concentrated load:	$p := 0 \cdot \text{lb}$	$c := 1 - a$	
Weight per lineal foot:	$w := (50 + 40)4 \cdot \text{plf}$		
Material:	$i := \text{LVL}$		
Allowable bending stress Fb:	$Fb_i = 2600 \cdot \text{psi}$	Allowable shear stress Fv:	$Fv_i = 285 \cdot \text{psi}$
Modulus of elasticity E:	$E_i = 2000000 \cdot \text{psi}$		
Cd = load duration factor:	$Cd := 1.0$		
Cr = repetitive use factor:	$Cr := 1.0$		
Calculate bending moment:	$M := \frac{p \cdot a \cdot c}{1} + \left(w \cdot \frac{l^2}{8} \right)$	$M = 2880 \cdot \text{ft} \cdot \text{lb}$	
Calculate the shear:	$V := \frac{p \cdot a}{1} + \left(w \cdot \frac{l}{2} \right)$	$V = 1440 \cdot \text{lb}$	
Use: (2) 1 3/4 X 9 1/2 LVL	$b := 3.5 \cdot \text{in}$	$d := 9.5 \cdot \text{in}$	$t := \text{if}(d \leq 12 \cdot \text{in}, 12 \cdot \text{in}, d)$
CF = Size factor (sawn lumber only)	$C_{1i} := \text{if}(d > 4 \cdot \text{in}, \text{if}(d > 6 \cdot \text{in}, \text{if}(d > 8 \cdot \text{in}, 1.1, 1.2), 1.3), 1.5)$	$C_1 := \text{if}(d > 10 \cdot \text{in}, \text{if}(d > 12 \cdot \text{in}, 0.9, 1.0), C_2 := C_1$	$C_1 = 1.1$
Cv = volume factor (glu-laminated lumber only)	$C_3 := 1 \cdot \left(21 \cdot \frac{\text{ft}}{1} \right)^{.1} \cdot \left(12 \cdot \frac{\text{in}}{d} \right)^{.1} \cdot \left(5.125 \cdot \frac{\text{in}}{b} \right)^{.1}$	$C_3 := \text{if}(C_3 > 1, 1, C_3)$	$C_3 = 1$
CF = LSL size factor:	$C_4 := \left(\frac{12 \cdot \text{in}}{t} \right)^{0.092}$	$C_4 = 1$	CF = LVL size factor: $C_5 := \left(\frac{12 \cdot \text{in}}{t} \right)^{0.136}$ $C_5 = 1$
CF = PSL size factor:	$C_6 := \left(\frac{12 \cdot \text{in}}{t} \right)^{0.111}$	$C_6 = 1$	$C_8 := C_1$ $C_9 := C_1$
Required section modulus:	$S_{ww} := \frac{M}{Fb_i \cdot Cd \cdot Cr \cdot C_i}$	$S = 13.3 \cdot \text{in}^3$	
Actual section modulus:	$S_{ww} := \frac{b}{6} \cdot d^2$	$S = 52.6 \cdot \text{in}^3$	
Required area:	$A_{ww} := 1.5 \cdot \left(\frac{V - w \cdot d}{Fv_i} \right)$	$A = 6.1 \cdot \text{in}^2$	
Actual area:	$A_{ww} := b \cdot d$	$A = 33.2 \cdot \text{in}^2$	
Check deflection:	$I := \frac{b}{12} \cdot d^3$	$I = 250.1 \cdot \text{in}^4$	
Allowable deflection:		$\frac{1}{240} = 0.4 \cdot \text{in}$	$\frac{1}{360} = 0.267 \cdot \text{in}$
Actual deflection:	$y := \frac{p \cdot a^2 \cdot c^2}{3 \cdot E_i \cdot I} + \frac{5 \cdot w \cdot l^4}{384 \cdot E_i \cdot I}$	$y = 0.066 \cdot \text{in}$	$y \cdot \frac{40}{90} = 0.029 \cdot \text{in}$

SIMPLE BEAM - CONCENTRATED, AND UNIFORM LOAD

SECOND FLOOR FRAMING
2FB7 (WORST CASE)

Length:	$l := 8 \cdot \text{ft}$	$a := 5 \cdot \text{ft}$ (larger)	
Concentrated load:	$p := 1500 \cdot \text{lb}$	$c := 1 - a$	
Weight per lineal foot:	$w := (50 + 40)1 \cdot \text{plf}$		
Material:	$i := \text{LVL}$		
Allowable bending stress Fb:	$Fb_i = 2600 \cdot \text{psi}$	Allowable shear stress Fv:	$Fv_i = 285 \cdot \text{psi}$
Modulus of elasticity E:	$E_i = 2000000 \cdot \text{psi}$		
Cd = load duration factor:	$Cd := 1.0$		
Cr = repetitive use factor:	$Cr := 1.0$		
Calculate bending moment:	$M := \frac{p \cdot a \cdot c}{1} + \left(w \cdot \frac{l^2}{8} \right)$	$M = 3532.5 \cdot \text{ft} \cdot \text{lb}$	
Calculate the shear:	$V_w := \frac{p \cdot a}{1} + \left(w \cdot \frac{l}{2} \right)$	$V = 1297.5 \cdot \text{lb}$	
Use: (2) 1 3/4 X 9 1/2 LVL	$b := 3.5 \cdot \text{in}$	$d := 9.5 \cdot \text{in}$	$t := \text{if}(d \leq 12 \cdot \text{in}, 12 \cdot \text{in}, d)$
CF = Size factor (sawn lumber only)	$C_{1w} := \text{if}(d > 4 \cdot \text{in}, \text{if}(d > 6 \cdot \text{in}, \text{if}(d > 8 \cdot \text{in}, 1.1, 1.2), 1.3), 1.5)$		
	$C_1 := \text{if}(d > 10 \cdot \text{in}, \text{if}(d > 12 \cdot \text{in}, 0.9, 1.0), C_2 := C_1$	$C_1 = 1.1$	
Cv = volume factor (glu-laminated lumber only)	$C_3 := 1 \cdot \left(21 \cdot \frac{\text{ft}}{1} \right)^{-1} \cdot \left(12 \cdot \frac{\text{in}}{d} \right)^{-1} \cdot \left(5.125 \cdot \frac{\text{in}}{b} \right)^{-1}$	$C_3 := \text{if}(C_3 > 1, 1, C_3)$	$C_3 = 1$
CF = LSL size factor:	$C_4 := \left(\frac{12 \cdot \text{in}}{t} \right)^{0.092}$	$C_4 = 1$	CF = LVL size factor: $C_5 := \left(\frac{12 \cdot \text{in}}{t} \right)^{0.136}$ $C_5 = 1$
CF = PSL size factor:	$C_6 := \left(\frac{12 \cdot \text{in}}{t} \right)^{0.111}$	$C_6 = 1$	$C_8 := C_1$ $C_9 := C_1$
Required section modulus:	$S_w := \frac{M}{Fb_i \cdot Cd \cdot Cr \cdot C_i}$	$S = 16.3 \cdot \text{in}^3$	
Actual section modulus:	$S_w := \frac{b}{6} \cdot d^2$	$S = 52.6 \cdot \text{in}^3$	
Required area:	$A_w := 1.5 \cdot \left(\frac{V - w \cdot d}{Fv_i} \right)$	$A = 6.5 \cdot \text{in}^2$	
Actual area:	$A_w := b \cdot d$	$A = 33.2 \cdot \text{in}^2$	
Check deflection:	$I := \frac{b}{12} \cdot d^3$	$I = 250.1 \cdot \text{in}^4$	
Allowable deflection:		$\frac{l}{240} = 0.4 \cdot \text{in}$	$\frac{l}{360} = 0.267 \cdot \text{in}$
Actual deflection:	$y := \frac{p \cdot a^2 \cdot c^2}{3 \cdot E_i \cdot I} + \frac{5 \cdot w \cdot l^4}{384 \cdot E_i \cdot I}$	$y = 0.065 \cdot \text{in}$	$y \cdot \frac{40}{90} = 0.029 \cdot \text{in}$

SIMPLE BEAM - CONCENTRATED, AND UNIFORM LOAD**SECOND FLOOR FRAMING
2FB8**

Length:	$l := 11 \cdot \text{ft}$	$a := 0 \cdot \text{ft}$	(larger)
Concentrated load:	$p := 0 \cdot \text{lb}$	$c := 1 - a$	
Weight per lineal foot:	$w := (50 + 40)9 \cdot \text{plf}$		
Material:	$i := \text{LVL}$		
Allowable bending stress F_b :	$F_{b_i} = 2600 \cdot \text{psi}$	Allowable shear stress F_v :	$F_{v_i} = 285 \cdot \text{psi}$
Modulus of elasticity E :	$E_i = 2000000 \cdot \text{psi}$		
C_d = load duration factor:	$C_d := 1.0$		
C_r = repetitive use factor:	$C_r := 1.0$		
Calculate bending moment:	$M := \frac{p \cdot a \cdot c}{1} + \left(w \cdot \frac{l^2}{8} \right)$	$M = 12251.3 \cdot \text{ft} \cdot \text{lb}$	
Calculate the shear:	$V := \frac{p \cdot a}{1} + \left(w \cdot \frac{l}{2} \right)$	$V = 4455 \cdot \text{lb}$	
Use: (3) 1 3/4 X 9 1/2 LVL	$b := 5.25 \cdot \text{in}$	$d := 9.5 \cdot \text{in}$	$t := \text{if}(d \leq 12 \cdot \text{in}, 12 \cdot \text{in}, d)$
C_F = Size factor (sawn lumber only)	$C_{F_1} := \text{if}(d > 4 \cdot \text{in}, \text{if}(d > 6 \cdot \text{in}, \text{if}(d > 8 \cdot \text{in}, 1.1, 1.2), 1.3), 1.5)$	$C_1 := \text{if}(d > 10 \cdot \text{in}, \text{if}(d > 12 \cdot \text{in}, 0.9, 1.0), C_2 := C_1$	$C_1 = 1.1$
C_v = volume factor (glu-laminated lumber only)	$C_3 := 1 \cdot \left(21 \cdot \frac{\text{ft}}{1} \right)^{-1} \cdot \left(12 \cdot \frac{\text{in}}{d} \right)^{-1} \cdot \left(5.125 \cdot \frac{\text{in}}{b} \right)^{-1}$	$C_3 := \text{if}(C_3 > 1, 1, C_3)$	$C_3 = 1$
C_F = LSL size factor:	$C_4 := \left(\frac{12 \cdot \text{in}}{t} \right)^{0.092}$	$C_4 = 1$	C_F = LVL size factor: $C_5 := \left(\frac{12 \cdot \text{in}}{t} \right)^{0.136}$ $C_5 = 1$
C_F = PSL size factor:	$C_6 := \left(\frac{12 \cdot \text{in}}{t} \right)^{0.111}$	$C_6 = 1$	$C_8 := C_1$ $C_9 := C_1$
Required section modulus:	$S_{ww} := \frac{M}{F_{b_i} \cdot C_d \cdot C_r \cdot C_1}$	$S = 56.5 \cdot \text{in}^3$	
Actual section modulus:	$S_{ww} := \frac{b}{6} \cdot d^2$	$S = 79 \cdot \text{in}^3$	
Required area:	$A_{ww} := 1.5 \cdot \left(\frac{V - w \cdot d}{F_{v_i}} \right)$	$A = 20.1 \cdot \text{in}^2$	
Actual area:	$A_{ww} := b \cdot d$	$A = 49.9 \cdot \text{in}^2$	
Check deflection:	$I := \frac{b}{12} \cdot d^3$	$I = 375.1 \cdot \text{in}^4$	
Allowable deflection:		$\frac{l}{240} = 0.55 \cdot \text{in}$	$\frac{l}{360} = 0.367 \cdot \text{in}$
Actual deflection:	$y := \frac{p \cdot a^2 \cdot c^2}{3 \cdot E_i \cdot I} + \frac{5 \cdot w \cdot l^4}{384 \cdot E_i \cdot I}$	$y = 0.356 \cdot \text{in}$	$y \cdot \frac{40}{90} = 0.158 \cdot \text{in}$

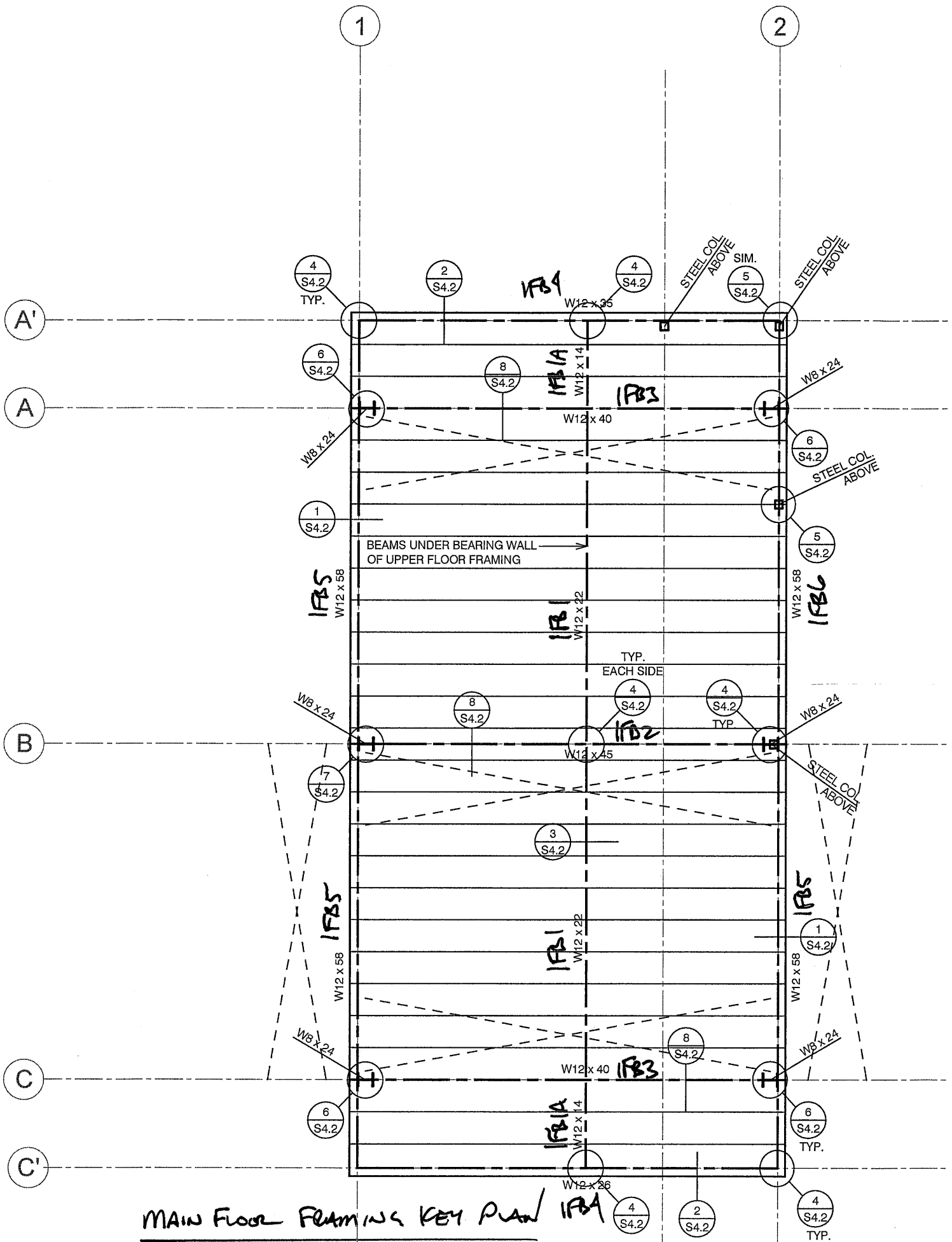

MAIN FLOOR FRAMING KEY PLAN IFB4

Project:
 Engineer:
 Descrip: 1FB1

Page # ____
 7/21/2017

ASDIP Steel 4.1.1

STEEL BEAM DESIGN

www.asdipsoft.com

GEOMETRY				PROPERTIES			
Beam Designation	W12X22			Area ..	6.5 in ²	Sx ...	25.4 in ³
Steel Yield Strength Fy ...	50.0	ksi	OK	Depth	12.3 in	Zx ...	29.3 in ³
Modulus of Elasticity Es ..	29000	ksi		bf	4.0 in	rx	4.91 in
Member Length L	14.00	ft		tw	0.26 in	ly	4.7 in ⁴
Left Cantilever	0.00	ft		tf	0.43 in	Sy ...	2.3 in ³
Right Cantilever	0.00	ft		k des .	0.73 in	Zy ...	3.7 in ³
Unbraced Length Lb top ..	0.00	ft		lx	156.0 in ⁴	ry	0.85 in
Unbraced Length Lb bot ..	14.00	ft		Cw	164.0 in ⁶	J	0.29 in ⁴

UNFACTORED LOADS (Selfweight calculated internally)

SPAN 1	Uniform (k/ft)		Concentrated (kip)						Moments (k-ft)	
	w1	w2	P1	P2	P3	P4	P5	P6	ML	MR
Const. Dead Load .	0.00	0.00	0.0	0.0	0.0	0.0	0.0	0.0	0.0	0.0
Const. Live Load ...	0.00	0.00	0.0	0.0	0.0	0.0	0.0	0.0	0.0	0.0
Dead Load	0.90	0.00	0.0	0.0	0.0	0.0	0.0	0.0	0.0	0.0
Live Load	0.72	0.00	0.0	0.0	0.0	0.0	0.0	0.0	0.0	0.0
Roof Live Load	0.00	0.00	0.0	0.0	0.0	0.0	0.0	0.0	0.0	0.0
Snow Load	0.00	0.00	0.0	0.0	0.0	0.0	0.0	0.0	0.0	0.0
Wind Load	0.00	0.00	0.0	0.0	0.0	0.0	0.0	0.0	0.0	0.0
Seismic Load	0.00	0.00	0.0	0.0	0.0	0.0	0.0	0.0	0.0	0.0
Start Distance (ft) ..	0.00	0.00	0.00	0.00	0.00	0.00	0.00	0.00		
End Distance (ft) ...	14.00	0.00								

Project:
 Engineer:
 Descip: 1FB1

Page # ____
 7/21/2017

ASDIP Steel 4.1.1

STEEL BEAM DESIGN

www.asdipsoft.com

FLEXURE DESIGN (STEEL)

L. T. Buckling Cb-factor	1.14
Max. Bending Moment M ..	55.0 k-ft
Limit States	Nominal Mn
Yielding	122.1 k-ft
Lateral Torsional Buckling	122.1 k-ft
Flange Local Buckling	N.A. k-ft
Web Local Buckling	N.A. k-ft
Nominal Strength Mn	109.9 k-ft
Resistance Factor ϕ	0.90
Design Strength ϕ Mn	109.9 k-ft
M / ϕ Mn Design Ratio	0.50 OK

FLEXURE DESIGN (COMPOSITE)

Overall Slab Thickness	N.A
<i>Interior Beam. Spacing = 5.0 ft</i>	
Effective Slab Width	N.A
Concrete Strength f_c	N.A
Concrete Density	N.A
Metal Deck Type	None None
Deck Ribs Height hr	N.A
Deck Ribs Avg. Width wr ..	N.A
<i>No Metal Deck specified for this Beam</i>	
Max. Bending Moment M	N.A
Limit States	Nominal Mn
Plastic Yielding	N.A
Elastic Yielding	N.A.
Nominal Strength Mn	N.A
Resistance Factor ϕ	0.90
Design Strength ϕ Mn	N.A
M / ϕ Mn Design Ratio	N.A

DEFLECTIONS

Stiffness factor	1.0			
Required Camber	0.00 in			
Long-term Deflection	N.A.			
Loading	δ (in)	L/ δ	L/ δ Min	Ratio
CL	0.00	9999	360	0.04 OK
CD+CL ..	0.00	9999	240	0.02 OK
L	0.14	1221	360	0.29 OK
D+L	0.31	536	240	0.45 OK

DESIGN FOR SHEAR

Shear Coefficient Cv	1.00
Maximum Shear Force V ...	15.8 kip
Limit States	Nominal Vn
Shear Yielding	95.9 kip
Shear Buckling	95.9 kip
Nominal Strength Vn	95.9 kip
Resistance Factor ϕ	1.00
Design Strength ϕ Vn	95.9 kip
V / ϕ Vn Design Ratio	0.16 OK

LOCAL BUCKLING

Flanges in Flexure	Compact
Flanges in Compression	Non-compact
Web in Flexure	Compact
Web in Compression	Non-compact

SHEAR CONNECTORS

Shear Stud Diameter	N.A
Shear Stud Length	N.A
Tensile Strength Fu	N.A
Nominal Strength Qn	N.A
Horizontal Shear Force	N.A
# of Studs for Full Composite	N.A
# of Studs for Partial Composite ..	N.A
Partial Composite Action %	N.A
Minimum Spacing Allowed	N.A
# of Studs at Any Section	N.A
Max. Spacing Required	N.A

DESIGN CODES

Steel Design	AISC 360-10 (14th Ed.)
Load Combinations ...	ASCE 7-10

Project:
 Engineer:
 Descrip: 1FB1A

Page # ____
 7/21/2017

ASDIP Steel 4.1.1

STEEL BEAM DESIGN

www.asdipsoft.com

GEOMETRY				PROPERTIES			
Beam Designation	W12X14		Area ..	4.2 in ²	Sx ...	14.9 in ³
Steel Yield Strength Fy	...	50.0 ksi	OK	Depth	11.9 in	Zx ...	17.4 in ³
Modulus of Elasticity Es	..	29000 ksi		bf	4.0 in	rx	4.62 in
Member Length L	6.00 ft		tw	0.20 in	ly	2.4 in ⁴
Left Cantilever	0.00 ft		tf	0.23 in	Sy ...	1.2 in ³
Right Cantilever	0.00 ft		k des .	0.53 in	Zy ...	1.9 in ³
Unbraced Length Lb top	..	0.00 ft		lx	88.6 in ⁴	ry	0.75 in
Unbraced Length Lb bot	..	6.00 ft		Cw	80.4 in ⁶	J	0.07 in ⁴

UNFACTORED LOADS (Selfweight calculated internally)

	Uniform (k/ft)		Concentrated (kip)						Moments (k-ft)	
	w1	w2	P1	P2	P3	P4	P5	P6	ML	MR
SPAN 1										
Const. Dead Load	0.00	0.00	0.0	0.0	0.0	0.0	0.0	0.0	0.0	0.0
Const. Live Load	0.00	0.00	0.0	0.0	0.0	0.0	0.0	0.0	0.0	0.0
Dead Load	0.90	0.00	0.0	0.0	0.0	0.0	0.0	0.0	0.0	0.0
Live Load	0.72	0.00	0.0	0.0	0.0	0.0	0.0	0.0	0.0	0.0
Roof Live Load	0.00	0.00	0.0	0.0	0.0	0.0	0.0	0.0	0.0	0.0
Snow Load	0.00	0.00	0.0	0.0	0.0	0.0	0.0	0.0	0.0	0.0
Wind Load	0.00	0.00	0.0	0.0	0.0	0.0	0.0	0.0	0.0	0.0
Seismic Load	0.00	0.00	0.0	0.0	0.0	0.0	0.0	0.0	0.0	0.0
Start Distance (ft)	0.00	0.00	0.00	0.00	0.00	0.00	0.00	0.00		
End Distance (ft)	6.00	0.00								

Project:
 Engineer:
 Descrip: 1FB1A

Page # ____
 7/21/2017

ASDIP Steel 4.1.1

STEEL BEAM DESIGN

www.asdipsoft.com

FLEXURE DESIGN (STEEL)

L. T. Buckling Cb-factor	1.14
Max. Bending Moment M ..	10.1 k-ft
Limit States	Nominal Mn
Yielding	72.5 k-ft <input type="checkbox"/>
Lateral Torsional Buckling	72.5 k-ft
Flange Local Buckling	N.A. k-ft
Web Local Buckling	N.A. k-ft
Nominal Strength Mn	65.3 k-ft
Resistance Factor ϕ	0.90
Design Strength ϕ Mn	65.3 k-ft
M / ϕ Mn Design Ratio	0.16 OK

FLEXURE DESIGN (COMPOSITE)

Overall Slab Thickness	N.A
<i>Interior Beam. Spacing = 5.0 ft</i>	
Effective Slab Width	N.A
Concrete Strength f_c	N.A
Concrete Density	N.A
Metal Deck Type	None None
Deck Ribs Height hr	N.A
Deck Ribs Avg. Width wr ..	N.A
<i>No Metal Deck specified for this Beam</i>	
Max. Bending Moment M	N.A
Limit States	Nominal Mn
Plastic Yielding	N.A
Elastic Yielding	N.A.
Nominal Strength Mn	N.A
Resistance Factor ϕ	0.90
Design Strength ϕ Mn	N.A
M / ϕ Mn Design Ratio	N.A

DEFLECTIONS

Stiffness factor	1.0				
Required Camber	0.00 in				
Long-term Deflection	N.A.				
Loading	δ (in)	L/ δ	L/ δ Min	Ratio	
CL	0.00	7200	360	0.05	OK
CD+CL ..	0.00	7200	240	0.03	OK
L	0.01	7200	360	0.05	OK
D+L	0.02	3883	240	0.06	OK

DESIGN FOR SHEAR

Shear Coefficient Cv	1.00
Maximum Shear Force V ...	6.7 kip
Limit States	Nominal Vn
Shear Yielding	71.4 kip <input type="checkbox"/>
Shear Buckling	71.4 kip
Nominal Strength Vn	71.4 kip
Resistance Factor ϕ	0.90
Design Strength ϕ Vn	64.3 kip
V / ϕ Vn Design Ratio	0.10 OK

LOCAL BUCKLING

Flanges in Flexure	Compact
Flanges in Compression	Non-compact
Web in Flexure	Compact
Web in Compression	Non-compact

SHEAR CONNECTORS

Shear Stud Diameter	N.A
Shear Stud Length	N.A
Tensile Strength F_u	N.A
Nominal Strength Q_n	N.A
Horizontal Shear Force	N.A
# of Studs for Full Composite	N.A
# of Studs for Partial Composite ..	N.A
Partial Composite Action %	N.A
Minimum Spacing Allowed	N.A
# of Studs at Any Section	N.A
Max. Spacing Required	N.A

DESIGN CODES

Steel Design	AISC 360-10 (14th Ed.)
Load Combinations ...	ASCE 7-10

Project:
 Engineer:
 Descip: 1FB2

Page # ____
 7/21/2017

ASDIP Steel 4.1.1

STEEL BEAM DESIGN

www.asdipsoft.com

GEOMETRY				PROPERTIES			
Beam Designation	W12X45			Area ..	13.1 in ²	Sx ...	57.7 in ³
Steel Yield Strength Fy ...	50.0	ksi	OK	Depth	12.1 in	Zx ...	64.2 in ³
Modulus of Elasticity Es ..	29000	ksi		bf	8.1 in	rx	5.15 in
Member Length L	24.00	ft		tw	0.34 in	ly	50.0 in ⁴
Left Cantilever	0.00	ft		tf	0.58 in	Sy ...	12.4 in ³
Right Cantilever	0.00	ft		k des .	1.08 in	Zy ...	19.0 in ³
Unbraced Length Lb top ..	0.00	ft		lx	348.0 in ⁴	ry	1.95 in
Unbraced Length Lb bot ..	24.00	ft		Cw	1650.0 in ⁶	J	1.26 in ⁴

UNFACTORED LOADS (Selfweight calculated internally)

SPAN 1	Uniform (k/ft)		Concentrated (kip)						Moments (k-ft)	
	w1	w2	P1	P2	P3	P4	P5	P6	ML	MR
Const. Dead Load .	0.00	0.00	0.0	0.0	0.0	0.0	0.0	0.0	0.0	0.0
Const. Live Load ...	0.00	0.00	0.0	0.0	0.0	0.0	0.0	0.0	0.0	0.0
Dead Load	0.00	0.00	12.6	0.0	0.0	0.0	0.0	0.0	0.0	0.0
Live Load	0.00	0.00	10.1	0.0	0.0	0.0	0.0	0.0	0.0	0.0
Roof Live Load	0.00	0.00	0.0	0.0	0.0	0.0	0.0	0.0	0.0	0.0
Snow Load	0.00	0.00	0.0	0.0	0.0	0.0	0.0	0.0	0.0	0.0
Wind Load	0.00	0.00	0.0	0.0	0.0	0.0	0.0	0.0	0.0	0.0
Seismic Load	0.00	0.00	0.0	0.0	0.0	0.0	0.0	0.0	0.0	0.0
Start Distance (ft) ..	0.00	0.00	12.00	0.00	0.00	0.00	0.00	0.00		
End Distance (ft) ...	24.00	0.00								

Project:
 Engineer:
 Descrip: 1FB2

Page # ____
 7/21/2017

ASDIP Steel 4.1.1

STEEL BEAM DESIGN

www.asdipsoft.com

FLEXURE DESIGN (STEEL)

L. T. Buckling Cb-factor	1.47
Max. Bending Moment M ..	187.7 k-ft
Limit States	Nominal Mn
Yielding	267.5 k-ft <input type="checkbox"/>
Lateral Torsional Buckling	267.5 k-ft
Flange Local Buckling	N.A. k-ft
Web Local Buckling	N.A. k-ft
Nominal Strength Mn	240.8 k-ft
Resistance Factor ϕ	0.90
Design Strength ϕ Mn	240.8 k-ft
M / ϕ Mn Design Ratio	0.78 OK

FLEXURE DESIGN (COMPOSITE)

Overall Slab Thickness	N.A
<i>Interior Beam. Spacing = 5.0 ft</i>	
Effective Slab Width	N.A
Concrete Strength f_c	N.A
Concrete Density	N.A
Metal Deck Type	None None
Deck Ribs Height hr	N.A
Deck Ribs Avg. Width wr ..	N.A
<i>No Metal Deck specified for this Beam</i>	
Max. Bending Moment M	N.A
Limit States	Nominal Mn
Plastic Yielding	N.A
Elastic Yielding	N.A.
Nominal Strength Mn	N.A
Resistance Factor ϕ	0.90
Design Strength ϕ Mn	N.A
M / ϕ Mn Design Ratio	N.A

DEFLECTIONS

Stiffness factor	1.0				
Required Camber	0.00 in				
Long-term Deflection	N.A.				
Loading	δ (in)	L/ δ	L/ δ Min	Ratio	
CL	0.00	9999	360	0.04	OK
CD+CL ..	0.03	8652	240	0.03	OK
L	0.50	578	360	0.62	OK
D+L	1.15	250	240	0.96	OK

DESIGN FOR SHEAR

Shear Coefficient Cv	1.00
Maximum Shear Force V ...	16.3 kip
Limit States	Nominal Vn
Shear Yielding	121.6 kip <input type="checkbox"/>
Shear Buckling	121.6 kip
Nominal Strength Vn	121.6 kip
Resistance Factor ϕ	1.00
Design Strength ϕ Vn	121.6 kip
V / ϕ Vn Design Ratio	0.13 OK

LOCAL BUCKLING

Flanges in Flexure	Compact
Flanges in Compression	Non-compact
Web in Flexure	Compact
Web in Compression	Non-compact

SHEAR CONNECTORS

Shear Stud Diameter	N.A
Shear Stud Length	N.A
Tensile Strength Fu	N.A
Nominal Strength Qn	N.A
Horizontal Shear Force	N.A
# of Studs for Full Composite	N.A
# of Studs for Partial Composite ..	N.A
Partial Composite Action %	N.A
Minimum Spacing Allowed	N.A
# of Studs at Any Section	N.A
Max. Spacing Required	N.A

DESIGN CODES

Steel Design	AISC 360-10 (14th Ed.)
Load Combinations ...	ASCE 7-10

Project:
 Engineer:
 Descrip: 1FB3

Page # ____
 7/21/2017

ASDIP Steel 4.1.1

STEEL BEAM DESIGN

www.asdipsoft.com

GEOMETRY				PROPERTIES			
Beam Designation	W12X40			Area ..	11.7 in ²	Sx ...	51.5 in ³
Steel Yield Strength Fy ...	50.0 ksi	OK		Depth	11.9 in	Zx ...	57.0 in ³
Modulus of Elasticity Es ..	29000 ksi			bf	8.0 in	rx	5.13 in
Member Length L	24.00 ft			tw	0.30 in	ly	44.1 in ⁴
Left Cantilever	0.00 ft			tf	0.52 in	Sy ...	11.0 in ³
Right Cantilever	0.00 ft			k des .	1.02 in	Zy ...	16.8 in ³
Unbraced Length Lb top ..	0.00 ft			lx	307.0 in ⁴	ry	1.94 in
Unbraced Length Lb bot ..	24.00 ft			Cw	1440.0 in ⁶	J	0.91 in ⁴

UNFACTORED LOADS (Selfweight calculated internally)

	Uniform (k/ft)		Concentrated (kip)						Moments (k-ft)	
	w1	w2	P1	P2	P3	P4	P5	P6	ML	MR
SPAN 1										
Const. Dead Load .	0.00	0.00	0.0	0.0	0.0	0.0	0.0	0.0	0.0	0.0
Const. Live Load ...	0.00	0.00	0.0	0.0	0.0	0.0	0.0	0.0	0.0	0.0
Dead Load	0.00	0.00	8.1	0.0	0.0	0.0	0.0	0.0	0.0	0.0
Live Load	0.00	0.00	6.5	0.0	0.0	0.0	0.0	0.0	0.0	0.0
Roof Live Load	0.00	0.00	0.0	0.0	0.0	0.0	0.0	0.0	0.0	0.0
Snow Load	0.00	0.00	0.0	0.0	0.0	0.0	0.0	0.0	0.0	0.0
Wind Load	0.00	0.00	0.0	0.0	0.0	0.0	0.0	0.0	0.0	0.0
Seismic Load	0.00	0.00	0.0	0.0	0.0	0.0	0.0	0.0	0.0	0.0
Start Distance (ft) ..	0.00	0.00	12.00	0.00	0.00	0.00	0.00	0.00		
End Distance (ft) ...	24.00	0.00								

FLEXURE DESIGN (STEEL)

L. T. Buckling Cb-factor	1.47
Max. Bending Moment M ..	121.7 k-ft
Limit States	Nominal Mn
Yielding	237.5 k-ft <input type="checkbox"/>
Lateral Torsional Buckling	237.5 k-ft
Flange Local Buckling	N.A. k-ft
Web Local Buckling	N.A. k-ft
Nominal Strength Mn	213.8 k-ft
Resistance Factor ϕ	0.90
Design Strength ϕ Mn	213.8 k-ft
M / ϕ Mn Design Ratio	0.57 OK

FLEXURE DESIGN (COMPOSITE)

Overall Slab Thickness	N.A
<i>Interior Beam. Spacing = 5.0 ft</i>	
Effective Slab Width	N.A
Concrete Strength f_c	N.A
Concrete Density	N.A
Metal Deck Type	None None
Deck Ribs Height hr	N.A
Deck Ribs Avg. Width wr ..	N.A
<i>No Metal Deck specified for this Beam</i>	
Max. Bending Moment M	N.A
Limit States	Nominal Mn
Plastic Yielding	N.A
Elastic Yielding	N.A.
Nominal Strength Mn	N.A
Resistance Factor ϕ	0.90
Design Strength ϕ Mn	N.A
M / ϕ Mn Design Ratio	N.A

DEFLECTIONS

Stiffness factor	1.0				
Required Camber	0.00 in				
Long-term Deflection	N.A.				
Loading	δ (in)	L/ δ	L/ δ Min	Ratio	
CL	0.00	9999	360	0.04	OK
CD+CL ..	0.03	8587	240	0.03	OK
L	0.36	793	360	0.45	OK
D+L	0.85	339	240	0.71	OK

DESIGN FOR SHEAR

Shear Coefficient Cv	1.00
Maximum Shear Force V ...	10.6 kip
Limit States	Nominal Vn
Shear Yielding	105.3 kip <input type="checkbox"/>
Shear Buckling	105.3 kip
Nominal Strength Vn	105.3 kip
Resistance Factor ϕ	1.00
Design Strength ϕ Vn	105.3 kip
V / ϕ Vn Design Ratio	0.10 OK

LOCAL BUCKLING

Flanges in Flexure	Compact
Flanges in Compression	Non-compact
Web in Flexure	Compact
Web in Compression	Non-compact

SHEAR CONNECTORS

Shear Stud Diameter	N.A
Shear Stud Length	N.A
Tensile Strength F_u	N.A
Nominal Strength Q_n	N.A
Horizontal Shear Force	N.A
# of Studs for Full Composite	N.A
# of Studs for Partial Composite ..	N.A
Partial Composite Action %	N.A
Minimum Spacing Allowed	N.A
# of Studs at Any Section	N.A
Max. Spacing Required	N.A

DESIGN CODES

Steel Design	AISC 360-10 (14th Ed.)
Load Combinations ...	ASCE 7-10

Project:
 Engineer:
 Descip: 1FB4

Page # ____
 7/21/2017

ASDIP Steel 4.1.1

STEEL BEAM DESIGN

www.asdipsoft.com

GEOMETRY				PROPERTIES			
Beam Designation	W12X26			Area ..	7.7 in ²	Sx ...	33.4 in ³
Steel Yield Strength Fy ...	50.0 ksi	OK		Depth	12.2 in	Zx ...	37.2 in ³
Modulus of Elasticity Es ..	29000 ksi			bf	6.5 in	rx	5.17 in
Member Length L	24.00 ft			tw	0.23 in	ly	17.3 in ⁴
Left Cantilever	0.00 ft			tf	0.38 in	Sy ...	5.3 in ³
Right Cantilever	0.00 ft			k des .	0.68 in	Zy ...	8.2 in ³
Unbraced Length Lb top ..	0.00 ft			lx	204.0 in ⁴	ry	1.51 in
Unbraced Length Lb bot ..	24.00 ft			Cw	607.0 in ⁶	J	0.30 in ⁴

UNFACTORED LOADS (Selfweight calculated internally)

SPAN 1	Uniform (k/ft)		Concentrated (kip)						Moments (k-ft)	
	w1	w2	P1	P2	P3	P4	P5	P6	ML	MR
Const. Dead Load .	0.00	0.00	0.0	0.0	0.0	0.0	0.0	0.0	0.0	0.0
Const. Live Load ...	0.00	0.00	0.0	0.0	0.0	0.0	0.0	0.0	0.0	0.0
Dead Load	0.30	0.00	1.8	0.0	0.0	0.0	0.0	0.0	0.0	0.0
Live Load	0.00	0.00	1.5	0.0	0.0	0.0	0.0	0.0	0.0	0.0
Roof Live Load	0.00	0.00	0.0	0.0	0.0	0.0	0.0	0.0	0.0	0.0
Snow Load	0.00	0.00	0.0	0.0	0.0	0.0	0.0	0.0	0.0	0.0
Wind Load	0.00	0.00	0.0	0.0	0.0	0.0	0.0	0.0	0.0	0.0
Seismic Load	0.00	0.00	0.0	0.0	0.0	0.0	0.0	0.0	0.0	0.0
Start Distance (ft) ..	0.00	0.00	12.00	0.00	0.00	0.00	0.00	0.00		
End Distance (ft) ...	24.00	0.00								

Project:
 Engineer:
 Descrip: 1FB4

Page # ____
 7/21/2017

ASDIP Steel 4.1.1

STEEL BEAM DESIGN

www.asdipsoft.com

FLEXURE DESIGN (STEEL)

L. T. Buckling Cb-factor	1.32
Max. Bending Moment M ..	42.8 k-ft
Limit States	
Yielding	155.0 k-ft
Lateral Torsional Buckling	155.0 k-ft
Flange Local Buckling	N.A. k-ft
Web Local Buckling	N.A. k-ft
Nominal Strength Mn	92.8 k-ft
Safety Factor Ω	1.67
Allowable Strength Mn/ Ω ...	92.8 k-ft
M / Mn/ Ω Design Ratio	0.46 OK

FLEXURE DESIGN (COMPOSITE)

Overall Slab Thickness	N.A
<i>Interior Beam. Spacing = 5.0 ft</i>	
Effective Slab Width	N.A
Concrete Strength f_c	N.A
Concrete Density	N.A
Metal Deck Type	None None
Deck Ribs Height hr	N.A
Deck Ribs Avg. Width wr ..	N.A
<i>No Metal Deck specified for this Beam</i>	
Max. Bending Moment M	N.A
Limit States	
Plastic Yielding	N.A
Elastic Yielding	N.A.
Nominal Strength Mn	N.A
Safety Factor Ω	1.67
Allowable Strength Mn/ Ω	N.A
M / Mn/ Ω Design Ratio	N.A

DEFLECTIONS

Stiffness factor	1.0				
Required Camber	0.00 in				
Long-term Deflection	N.A.				
Loading	δ (in)	L/δ	L/δ Min	Ratio	
CL	0.00	9999	360	0.04	OK
CD+CL ..	0.03	8779	240	0.03	OK
L	0.13	2282	360	0.16	OK
D+L	0.69	418	240	0.57	OK

DESIGN FOR SHEAR

Shear Coefficient Cv	1.00
Maximum Shear Force V ...	5.6 kip
Limit States	
Shear Yielding	84.2 kip
Shear Buckling	84.2 kip
Nominal Strength Vn	84.2 kip
Safety Factor Ω	1.50
Allowable Strength Vn/ Ω ..	56.1 kip
V / Vn/ Ω Design Ratio	0.10 OK

LOCAL BUCKLING

Flanges in Flexure	Compact
Flanges in Compression	Non-compact
Web in Flexure	Compact
Web in Compression	Non-compact

SHEAR CONNECTORS

Shear Stud Diameter	N.A
Shear Stud Length	N.A
Tensile Strength Fu	N.A
Nominal Strength Qn	N.A
Horizontal Shear Force	N.A
# of Studs for Full Composite	N.A
# of Studs for Partial Composite ..	N.A
Partial Composite Action %	N.A
Minimum Spacing Allowed	N.A
# of Studs at Any Section	N.A
Max. Spacing Required	N.A

DESIGN CODES

Steel Design	AISC 360-10 (14th Ed.)
Load Combinations ...	ASCE 7-10

Project:
 Engineer:
 Descip: 1FB5

Page # ____
 7/21/2017

ASDIP Steel 4.1.1

STEEL BEAM DESIGN

www.asdipsoft.com

GEOMETRY				PROPERTIES			
Beam Designation	W12X53			Area ..	15.6 in ²	Sx ...	70.6 in ³
Steel Yield Strength Fy ...	50.0 ksi	OK		Depth	12.1 in	Zx ...	77.9 in ³
Modulus of Elasticity Es ..	29000 ksi			bf	10.0 in	rx	5.23 in
Member Length L	14.00 ft			tw	0.35 in	ly	95.8 in ⁴
Left Cantilever	0.00 ft			tf	0.58 in	Sy ...	19.2 in ³
Right Cantilever	6.00 ft			k des .	1.18 in	Zy ...	29.1 in ³
Unbraced Length Lb top ..	0.00 ft			lx	425.0 in ⁴	ry	2.48 in
Unbraced Length Lb bot ..	14.00 ft			Cw	3160.0 in ⁶	J	1.58 in ⁴

UNFACTORED LOADS (Selfweight calculated internally)

	Uniform (k/ft)		Concentrated (kip)						Moments (k-ft)	
	w1	w2	P1	P2	P3	P4	P5	P6	ML	MR
SPAN 1										
Const. Dead Load .	0.00	0.00	0.0	0.0	0.0	0.0	0.0	0.0	0.0	0.0
Const. Live Load ...	0.00	0.00	0.0	0.0	0.0	0.0	0.0	0.0	0.0	0.0
Dead Load	0.70	0.00	0.0	0.0	0.0	0.0	0.0	0.0	0.0	0.0
Live Load	2.54	0.00	0.0	0.0	0.0	0.0	0.0	0.0	0.0	0.0
Roof Live Load	0.00	0.00	0.0	0.0	0.0	0.0	0.0	0.0	0.0	0.0
Snow Load	0.00	0.00	0.0	0.0	0.0	0.0	0.0	0.0	0.0	0.0
Wind Load	0.00	0.00	0.0	0.0	0.0	0.0	0.0	0.0	0.0	0.0
Seismic Load	0.00	0.00	0.0	0.0	0.0	0.0	0.0	0.0	0.0	0.0
Start Distance (ft) ..	0.00	0.00	0.00	0.00	0.00	0.00	0.00	0.00		
End Distance (ft) ...	0.00	0.00								
R CANT										
Const. Dead Load .	0.00	0.00	0.0	0.0	0.0	0.0	0.0	0.0	0.0	
Const. Live Load ...	0.00	0.00	0.0	0.0	0.0	0.0	0.0	0.0	0.0	
Dead Load	0.70	0.00	7.5	0.0	0.0	0.0	0.0	0.0	0.0	
Live Load	2.54	0.00	5.1	0.0	0.0	0.0	0.0	0.0	0.0	
Roof Live Load	0.00	0.00	0.0	0.0	0.0	0.0	0.0	0.0	0.0	
Snow Load	0.00	0.00	0.0	0.0	0.0	0.0	0.0	0.0	0.0	
Wind Load	0.00	0.00	0.0	0.0	0.0	0.0	0.0	0.0	0.0	
Seismic Load	0.00	0.00	0.0	0.0	0.0	0.0	0.0	0.0	0.0	
Start Distance (ft) ..	0.00	0.00	6.00	0.00	0.00	0.00	0.00	0.00	0.00	
End Distance (ft) ...	0.00	0.00								

P6

Project:
 Engineer:
 Descip: 1FB5

Page # ____
 7/21/2017

ASDIP Steel 4.1.1

STEEL BEAM DESIGN

www.asdipsoft.com

FLEXURE DESIGN (STEEL)

L. T. Buckling Cb-factor	1.70
Max. Bending Moment M ..	-104.1 k-ft
Limit States	Nominal Mn
Yielding	324.6 k-ft
Lateral Torsional Buckling	324.6 k-ft
Flange Local Buckling	N.A. k-ft
Web Local Buckling	N.A. k-ft
Nominal Strength Mn	292.1 k-ft
Resistance Factor ϕ	0.90
Design Strength ϕ Mn	292.1 k-ft
M / ϕ Mn Design Ratio	0.36 OK

FLEXURE DESIGN (COMPOSITE)

Overall Slab Thickness	N.A
<i>Interior Beam. Spacing = 5.0 ft</i>	
Effective Slab Width	N.A
Concrete Strength f_c	N.A
Concrete Density	N.A
Metal Deck Type	None None
Deck Ribs Height hr	N.A
Deck Ribs Avg. Width wr ..	N.A
<i>No Metal Deck specified for this Beam</i>	
Max. Bending Moment M	N.A
Limit States	Nominal Mn
Plastic Yielding	N.A
Elastic Yielding	N.A
Nominal Strength Mn	N.A
Resistance Factor ϕ	0.90
Design Strength ϕ Mn	N.A
M / ϕ Mn Design Ratio	N.A

DEFLECTIONS

Stiffness factor	1.0				
Required Camber	0.00 in				
Long-term Deflection	N.A.				
Loading	δ (in)	L/ δ	L/ δ Min	Ratio	
CL	0.00	9999	360	0.04	OK
CD+CL ..	0.00	9999	240	0.02	OK
L	0.29	247	180	0.73	OK
D+L	0.72	100	120	1.20	NG

DESIGN FOR SHEAR

Shear Coefficient Cv	1.00
Maximum Shear Force V ...	17.5 kip
Limit States	Nominal Vn
Shear Yielding	125.2 kip
Shear Buckling	125.2 kip
Nominal Strength Vn	125.2 kip
Resistance Factor ϕ	1.00
Design Strength ϕ Vn	125.2 kip
V / ϕ Vn Design Ratio	0.14 OK

LOCAL BUCKLING

Flanges in Flexure	Compact
Flanges in Compression	Non-compact
Web in Flexure	Compact
Web in Compression	Non-compact

SHEAR CONNECTORS

Shear Stud Diameter	N.A
Shear Stud Length	N.A
Tensile Strength Fu	N.A
Nominal Strength Qn	N.A
Horizontal Shear Force	N.A
# of Studs for Full Composite	N.A
# of Studs for Partial Composite ..	N.A
Partial Composite Action %	N.A
Minimum Spacing Allowed	N.A
# of Studs at Any Section	N.A
Max. Spacing Required	N.A

DESIGN CODES

Steel Design	AISC 360-10 (14th Ed.)
Load Combinations ...	ASCE 7-10



STEEL CODE: AISC 360-05 LRFD

SPAN INFORMATION (ft): I-End (0.00,0.00) J-End (19.50,0.00)

Maximum Depth Limitation specified = 13.00 in
 Beam Size (User Selected) = W12X58 Fy = 50.0 ksi
 Total Beam Length (ft) = 19.50
 Cantilever on right (ft) = 5.50
 Mp (kip-ft) = 360.00
 Top flange braced by decking.

POINT LOADS (kips):

Dist (ft)	DL	LL	Flange Bracing	
			Top	Bottom
19.500	7.30	21.90	No	No
11.500	4.60	39.30	No	No

LINE LOADS (k/ft):

Load	Dist (ft)	DL	LL
1	0.000	0.058	0.000
	14.000	0.058	0.000
2	14.000	0.058	0.000
	19.500	0.058	0.000
3	0.000	1.020	2.800
	14.000	1.020	2.800
4	14.000	0.140	0.110
	19.500	0.140	0.110

SHEAR (Ultimate): Max Vu (1.2DL+1.6LL) = 114.25 kips 1.00Vn = 131.76 kips

MOMENTS (Ultimate):

Span	Cond	LoadCombo	Mu kip-ft	@ ft	Lb ft	Cb	Phi	Phi*Mn kip-ft
Center	Max +	1.2DL+1.6LL	207.3	8.5	0.0	1.00	0.90	324.00
	Max -	1.2DL+1.6LL	-247.2	14.0	14.0	2.04	0.90	324.00
Right	Max -	1.2DL+1.6LL	-247.2	14.0	5.5	1.00	0.90	324.00
Controlling		1.2DL+1.6LL	-247.2	14.0	14.0	2.04	0.90	324.00

REACTIONS (kips):

	Left	Right
DL reaction	5.28	22.79
Max +LL reaction	26.62	83.11
Max -LL reaction	-8.72	0.00
Max +total reaction (factored)	48.93	160.33
Max -total reaction	-7.61	31.91

DEFLECTIONS:

Center span:

Dead load (in)	at	7.21 ft =	-0.018	L/D =	9481
Live load (in)	at	7.21 ft =	-0.321	L/D =	523
Net Total load (in)	at	7.21 ft =	-0.339	L/D =	496



Right cantilever:

Dead load (in)	= -0.080	L/D = 1654
Pos Live load (in)	= -0.547	L/D = 241
Neg Live load (in)	= 0.458	L/D = 289
Pos Total load (in)	= -0.627	L/D = 211
Neg Total load (in)	= 0.378	L/D = 349

COLUMNS BETWEEN MAIN PLATFORM AND FOUNDATION

Project:
 Engineer:
 Descrrip: Bottom Col

Page # ____
 7/13/2017

ASDIP Steel 4.0.9 **STEEL COLUMN DESIGN** www.asdipsoft.com

GEOMETRY

Column Designation	W8X24	
Steel Yield Strength F_y	50.0	ksi
Modulus of Elasticity E_s	29000	ksi
Member Length L	10.00	ft
Effective Length K_x -factor	1.00	
Effective Length K_y -factor	1.00	
Unbraced Length L_b	10.00	ft OK

PROPERTIES

Area ..	7.1	in ²	S_x ...	20.9	in ³
Depth	7.9	in	Z_x ...	23.1	in ³
bf	6.5	in	r_x ...	3.42	in
tw	0.25	in	I_y ...	18.3	in ⁴
tf	0.40	in	S_y ...	5.6	in ³
k_{des} .	0.79	in	Z_y ...	8.6	in ³
I_x	82.7	in ⁴	r_y ...	1.61	in
C_w ...	259.0	in ⁶	J ...	0.35	in ⁴

ASD SERVICE LOADS (2nd-Order Analysis)

Axial Force P	70.0	kip	
	Bottom	Top	
M_x due to Gravity	0.0	0.0	k-ft
M_x due to Lateral	20.0	30.0	k-ft
M_y due to Gravity	10.0	12.0	k-ft
M_y due to Lateral	7.0	10.0	k-ft

LOCAL BUCKLING

Flanges in Flexure	Compact
Flanges in Compression	Non-slender
Web in Flexure	Compact
Web in Compression	Non-slender

COMPRESSION

Slenderness Ratio $K_x L / r_x$	35.1
Slenderness Ratio $K_y L / r_y$	74.5
Max. Slenderness Ratio	74.5 OK
Limit States	Nominal P_n
Flexural Buckling	235.8 kip
Torsional Buckling	280.1 kip
Flexural-Torsional Buckling	N.A. kip
Nominal Strength P_n	235.8 kip
Safety Factor Ω	1.67
Allowable Strength P_n/Ω	141.2 kip
$P / P_n/\Omega$ Design Ratio	0.50 OK

BENDING ABOUT X-X

Moment at 1/4 point of L_b	N.A.	k-ft
Moment at 1/2 point of L_b	N.A.	k-ft
Moment at 3/4 point of L_b	N.A.	k-ft
L. T. Buckling C_b -factor	1.75	
Limit States	Nominal M_n	
Yielding	96.3 k-ft	
Lateral-Torsional Buckling	96.3 k-ft	
Flange Local Buckling	N.A. k-ft	
Web Local Buckling	N.A. k-ft	
Nominal Strength M_n	96.3 k-ft	
Safety Factor Ω	1.67	
Allowable Strength M_n/Ω	57.6 k-ft	
$M / M_n/\Omega$ Design Ratio	0.00 OK	

BENDING ABOUT Y-Y

Limit States	Nominal M_n
Yielding	35.7 k-ft
Lateral-Torsional Buckling	N.A. k-ft
Flange Local Buckling	N.A. k-ft
Web Local Buckling	N.A. k-ft
Nominal Strength M_n	35.7 k-ft
Safety Factor Ω	1.67
Allowable Strength M_n/Ω	21.4 k-ft
$M / M_n/\Omega$ Design Ratio	0.56 OK

COMBINED FORCES

AISC Equation {H1-1a}	0.99	OK
AISC Equation {H1-1b}	N.A.	

DESIGN CODES

Steel Design	AISC 360-10 (14th Ed.)
Load Combinations	User-defined

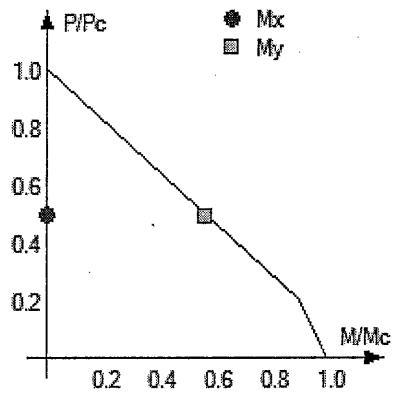
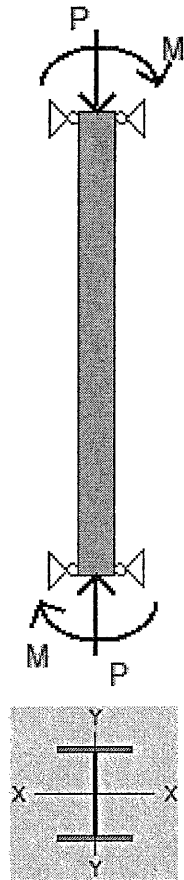

INTERACTION DIAGRAM

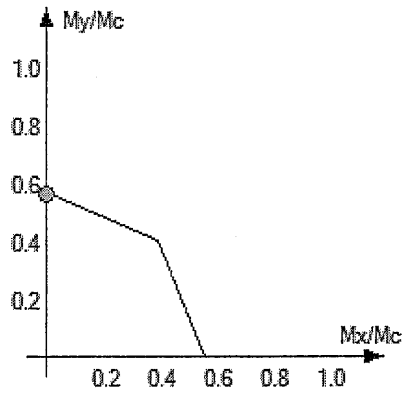

BIAxIAL BENDING DIAGRAM

Seismic Base Shear

This worksheet calculates the Seismic Loads applied to the building's main lateral load resisting system per ASCE 7-10, Chapters 11 and 12.

Number of Stories

$$N_w := 2$$

$$x := 1..N$$

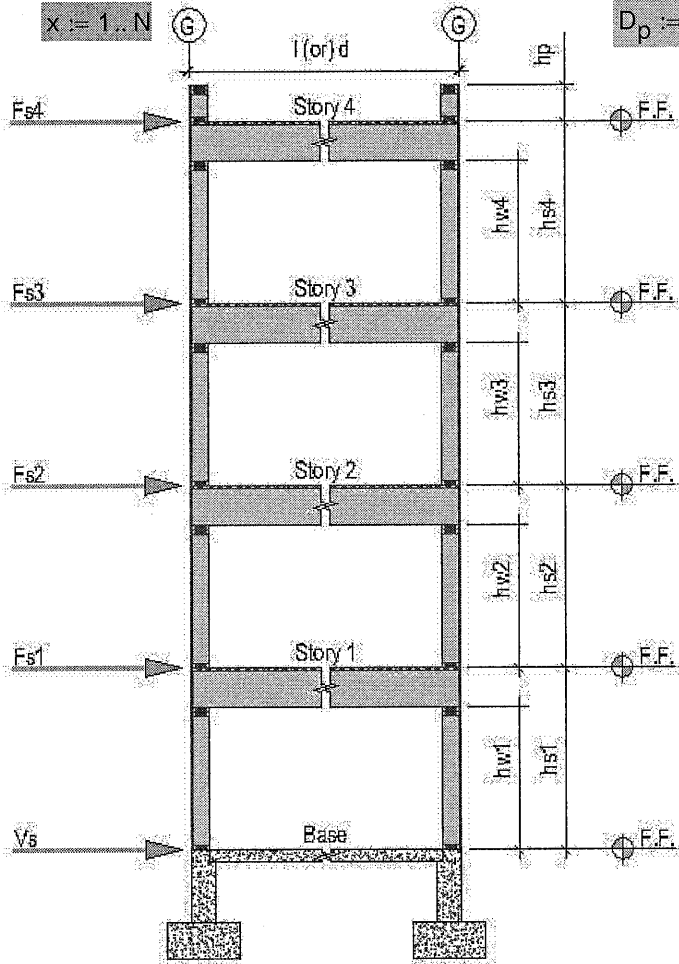

Parapet

$$h_p := 0 \text{ ft}$$

$$D_p := 0 \text{ psf}$$

Story 4

$$l_4 := 0 \text{ ft}$$

$$d_4 := 0 \text{ ft}$$

$$h_{s4} := 0 \text{ ft}$$

$$D_4 := 0 \text{ psf}$$

$$D_{w4} := 0 \text{ psf}$$

Story 3

$$l_3 := 0 \text{ ft}$$

$$d_3 := 0 \text{ ft}$$

$$h_{s3} := 0 \text{ ft}$$

$$D_3 := 0 \text{ psf}$$

$$D_{w3} := 0 \text{ psf}$$

Story 2

$$l_2 := 36 \text{ ft}$$

$$d_2 := 18 \text{ ft}$$

$$h_{s2} := 9 \text{ ft}$$

$$30\% \text{ snow } D_2 := (15 + 58) \text{ psf}$$

$$D_{w2} := 15 \text{ psf}$$

Story 1

$$l_1 := 36 \text{ ft}$$

$$d_1 := 18 \text{ ft}$$

$$h_{s1} := 10 \text{ ft}$$

$$D_1 := 50 \text{ psf}$$

$$D_{w1} := 15 \text{ psf}$$

Wood Shear Walls:

$$R_w := 6.5$$

(Table 12.2-1)

Determine the MCE SRA Parameters per Section 11.4:

Site Class: $SC := "D"$ (Table 20.3-1)

@ Short Periods

@ 1-second Period

$S_s := 0.898$

$S_1 := 0.304$

(Figures 22-1 thr. 22-14)

$S_{ds} := 0.683$

$S_{d1} := 0.363$

(Equations 11.4-3 & 11.4-4)

Determine the Seismic Design Category per Section 11.6:

Occupancy Category: $OC := 2$ (IBC Table 1604.5)

$I_e := 1.0$

(Table 11.5-1)

$SDC = "D"$

(Table 11.6-1)

Calculate the Effective Seismic Weight per Section 12.7.2:

Diaphragms: $wd_x := D_x \cdot l_x \cdot d_x$

$h_{s_{N+1}} := 2 \cdot h_{s_{N+1}}$

Walls: $ww_x := \left(D_{w_x} \cdot \frac{h_{s_x}}{2} + D_{w_{x+1}} \cdot \frac{h_{s_{x+1}}}{2} \right)$

Story Weight: $w_x := wd_x + ww_x \cdot (2 \cdot l_x + 2 \cdot d_x)$

$h_{s_{N+1}} := 0.5 \cdot h_{s_{N+1}}$

Total Weight: $\sum w$

$W = 102.4 \text{ kip}$

Calculate the Approximate Fundamental Period per Section 12.7.2:

$h_n := \sum_{i=1}^{N+1} \frac{h_{s_i}}{ft}$ (Section 12.8.2.1)

$C_t := 0.02$ (Table 12.8-2)

$X := 0.75$ (Table 12.8-2)

$T_a := C_t \cdot h_n^X$ (Equation 12.8-7)

Calculate the Fundamental Period per Section 12.7.2:

$$C_U := 1.5 \quad (\text{Table 12.8-1})$$

$$T_m := C_U \cdot T_a \quad (\text{Section 12.8.2})$$

$$T = 0.273$$

Determine the Long-period Transition Period per Section 11.4.5:

$$T_L := 8.0 \quad (\text{Figure 22-15})$$

Calculate the Seismic Response Coefficient per Section 12.8.1.1:

$$C_S := \frac{S_{ds} \cdot I_e}{R} \quad (\text{Equation 12.8-2})$$

$$C_{Smin} := \begin{cases} \frac{0.5 \cdot S_1 \cdot I_e}{R} & \text{if } S_1 > 0.60 \\ 0.01 & \text{otherwise} \end{cases} \quad (\text{Equations 12.8-5 \& 12.8-6})$$

$$C_{Smax} := \begin{cases} \frac{S_{d1} \cdot I_e}{R \cdot T} & \text{if } T \leq T_L \\ \frac{S_{d1} \cdot I_e \cdot T_L}{R \cdot T^2} & \text{if } T > T_L \end{cases} \quad (\text{Equations 12.8-3 \& 12.8-4})$$

$$C_S := \begin{cases} C_{Smin} & \text{if } C_S < C_{Smin} \\ C_{Smax} & \text{if } C_S > C_{Smax} \\ C_S & \text{otherwise} \end{cases}$$

$$C_S = 0.105$$

Calculate the Seismic Base Shear per Section 12.8.1:

$$V_S := C_S \cdot W \quad (\text{Equation 12.8-1})$$

$$V_S = 10.8 \cdot \text{kip} \quad \text{STRENGTH}$$

$$\frac{V_S}{1.4} = 7.7 \cdot \text{kip} \quad \text{ALLOWABLE}$$

Vertically Distribute the Seismic Base Shear per Section 12.8.3:

$$k_1 := \begin{pmatrix} 1 \\ 2 \end{pmatrix}$$

$$t_1 := \begin{pmatrix} 0.5 \\ 2.5 \end{pmatrix}$$

$$k_w := \begin{cases} 1.0 & \text{if } T < 0.5 \\ \text{interp}(t_1, k_1, T) & \text{if } 0.5 \leq T \leq 2.5 \\ 2.0 & \text{if } T > 2.5 \end{cases}$$

$$C_{V_x} := \frac{w_x \cdot \left(\sum_{i=1}^x \frac{h_{s_i}}{ft} \right)^k}{\sum_{i=1}^N \left[w_i \cdot \left(\sum_{j=1}^i \frac{h_{s_j}}{ft} \right)^k \right]} \quad \text{(Equation 12.8-12)}$$

$$F_{S_x} := C_{V_x} \cdot V_s \quad \text{(Equation 12.8-11)}$$

	STRENGTH	ALLOWABLE
(Story 4)	$F_{S_4} = \blacksquare \cdot \text{kip}$	$0.71 F_{S_4} = \blacksquare \cdot \text{kip}$
(Story 3)	$F_{S_3} = \blacksquare \cdot \text{kip}$	$0.71 F_{S_3} = \blacksquare \cdot \text{kip}$
(Story 2)	$F_{S_2} = 7.4 \cdot \text{kip}$	$0.71 F_{S_2} = 5.2 \cdot \text{kip}$
(Story 1)	$F_{S_1} = 3.4 \cdot \text{kip}$	$0.71 F_{S_1} = 2.4 \cdot \text{kip}$

Calculate the Diaphragm Design Force (perpendicular to L) per Section 12.10.1.1:

$$F_{psl_x} := \frac{\sum_{i=x}^N F_{S_i}}{\sum_{i=x}^N w_i} \cdot \left(\frac{w d_x}{l_x} + 2 \cdot w w_x \right) \quad \text{(Equation 12.10-1)}$$

$$F_{pslmin_x} := 0.2 \cdot S_{ds} \cdot l_e \cdot \left(\frac{w d_x}{l_x} + 2 \cdot w w_x \right) \quad \text{(Section 12.10.1.1)}$$

$$F_{pslmax_x} := 0.4 \cdot S_{ds} \cdot l_e \cdot \left(\frac{w d_x}{l_x} + 2 \cdot w w_x \right) \quad \text{(Section 12.10.1.1)}$$

$$F_{psl_x} := \begin{cases} F_{pslmin_x} & \text{if } F_{psl_x} < F_{pslmin_x} \\ F_{pslmax_x} & \text{if } F_{psl_x} > F_{pslmax_x} \\ F_{psl_x} & \text{otherwise} \end{cases}$$

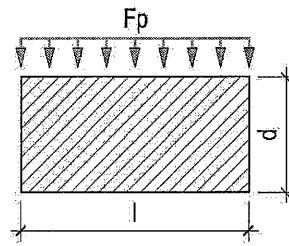

$$F_{psl_4} = \blacksquare \cdot plf \quad (\text{Story 4})$$

$$F_{psl_3} = \blacksquare \cdot plf \quad (\text{Story 3})$$

$$F_{psl_2} = 197.9 \cdot plf \quad (\text{Story 2})$$

$$F_{psl_1} = 161.9 \cdot plf \quad (\text{Story 1})$$

Calculate the Diaphragm Design Force (perpendicular to D) per Section 12.10.1.1:

$$F_{psd_x} := \frac{\sum_{i=x}^N F_{s_i}}{\sum_{i=x}^N w_i} \cdot \left(\frac{wd_x}{d_x} + 2 \cdot ww_x \right) \quad (\text{Equation 12.10-1})$$

$$F_{psdmin_x} := 0.2 \cdot S_{ds} \cdot I_e \cdot \left(\frac{wd_x}{d_x} + 2 \cdot ww_x \right) \quad (\text{Section 12.10.1.1})$$

$$F_{psdmax_x} := 0.4 \cdot S_{ds} \cdot I_e \cdot \left(\frac{wd_x}{d_x} + 2 \cdot ww_x \right) \quad (\text{Section 12.10.1.1})$$

$$F_{psd_x} := \begin{cases} F_{psdmin_x} & \text{if } F_{psd_x} < F_{psdmin_x} \\ F_{psdmax_x} & \text{if } F_{psd_x} > F_{psdmax_x} \\ F_{psd_x} & \text{otherwise} \end{cases}$$

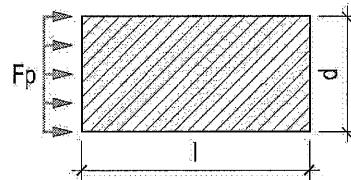

$$F_{psd_4} = \blacksquare \cdot plf \quad (\text{Story 4})$$

$$F_{psd_3} = \blacksquare \cdot plf \quad (\text{Story 3})$$

$$F_{psd_2} = 377.4 \cdot plf \quad (\text{Story 2})$$

$$F_{psd_1} = 284.8 \cdot plf \quad (\text{Story 1})$$

SHEAR WALLS - LINE 1

STORY2		PIERS	Length	Height	Tributary
# Piers in Shear Line:	$n_2 := 1$ (n = 8 max)	1:	$l_{21} := 14\text{-ft}$	$h_{21} := 9\text{-ft}$	$t_{21} := 9\text{-ft}$
Story Shear:	$F_{a2} := 5.2\text{-k}$ (Allowable)	2:	$l_{22} := 0\text{-ft}$	$h_{22} := 0\text{-ft}$	$t_{22} := 0\text{-ft}$
Shear Attributed To Line:	$V_{a2} := 2.6\text{-k}$ (Allowable)	3:	$l_{23} := 0\text{-ft}$	$h_{23} := 0\text{-ft}$	$t_{23} := 0\text{-ft}$
Story DL:	$DL_2 := 15\text{-psf}$	4:	$l_{24} := 0\text{-ft}$	$h_{24} := 0\text{-ft}$	$t_{24} := 0\text{-ft}$
Wall DL:	$DLw_2 := 15\text{-psf}$	5:	$l_{25} := 0\text{-ft}$	$h_{25} := 0\text{-ft}$	$t_{25} := 0\text{-ft}$
Redundancy	$\rho_2 := 1$	6:	$l_{26} := 0\text{-ft}$	$h_{26} := 0\text{-ft}$	$t_{26} := 0\text{-ft}$
		7:	$l_{27} := 0\text{-ft}$	$h_{27} := 0\text{-ft}$	$t_{27} := 0\text{-ft}$
		8:	$l_{28} := 0\text{-ft}$	$h_{28} := 0\text{-ft}$	$t_{28} := 0\text{-ft}$

SHEAR CALCULATIONS

Unit Shear (for walls):
$$v_2 := \frac{\rho_2 \cdot V_{a2}}{\sum l_2}$$

OVERTURNING CALCULATIONS $i_2 := 1..n_2$

Overturning Moment: $Mo_{2i_2} := v_2 \cdot h_{2i_2} \cdot l_{2i_2}$ $Mo_2 = (23.4) \cdot \text{k} \cdot \text{ft}$

Resisting Moment:
$$Mr_{2i_2} := 0.6 \cdot \left[\left(DL_2 \cdot t_{2i_2} \right) \cdot l_{2i_2} \cdot \left(\frac{l_{2i_2}}{2} \right) \right] + \left[\left(DLw_2 \cdot h_{2i_2} \right) \cdot l_{2i_2} \cdot \left(\frac{l_{2i_2}}{2} \right) \right]$$

Nominal Overturning: $M_{2i_2} := Mo_{2i_2} - Mr_{2i_2}$

Tension at Pier Ends:
$$T_{2i_2} := \frac{M_{2i_2}}{l_{2i_2}}$$

STORY 1

			PIERS	Length	Height	Tributary
# Piers in Shear Line:	$n_1 := 2$	($n = 8$ max)	1:	$l_{11} := 6\text{-ft}$	$h_{11} := 10\text{-ft}$	$t_{11} := 5\text{-ft}$
Story Shear:	$F_{a1} := 2.4\text{-k}$	(Allowable)	2:	$l_{12} := 15.5\text{-ft}$	$h_{12} := 10\text{-ft}$	$t_{12} := 5\text{-ft}$
Shear Attributed To Line:	$V_{a1} := 1.2\text{-k}$	(Allowable)	3:	$l_{13} := 0\text{-ft}$	$h_{13} := 0\text{-ft}$	$t_{13} := 0\text{-ft}$
Story DL:	$DL_1 := 50\text{-psf}$		4:	$l_{14} := 0\text{-ft}$	$h_{14} := 0\text{-ft}$	$t_{14} := 0\text{-ft}$
Wall DL:	$DLw_1 := 15\text{-psf}$		5:	$l_{15} := 0\text{-ft}$	$h_{15} := 0\text{-ft}$	$t_{15} := 0\text{-ft}$
Sill Plate Length:	$L_{s1} := 21.5\text{-ft}$		6:	$l_{16} := 0\text{-ft}$	$h_{16} := 0\text{-ft}$	$t_{16} := 0\text{-ft}$
Redundancy	$\rho_1 := 1$		7:	$l_{17} := 0\text{-ft}$	$h_{17} := 0\text{-ft}$	$t_{17} := 0\text{-ft}$
			8:	$l_{18} := 0\text{-ft}$	$h_{18} := 0\text{-ft}$	$t_{18} := 0\text{-ft}$

SHEAR CALCULATIONS

Unit Shear (for walls):
$$v_1 := \frac{(\rho_2 \cdot V_{a2} + \rho_1 \cdot V_{a1})}{\sum l_{1i}}$$

OVERTURNING CALCULATIONS $i_1 := 1..n_1$

Overturing Moment:
$$M_{o1i_1} := \left[\frac{(\rho_2 \cdot V_{a2} + \rho_1 \cdot V_{a1}) \cdot h_{1i_1}}{\sum l_{1i}} \right] \cdot l_{1i_1}$$

Resisting Moment:
$$M_{r1i_1} := 0.6 \cdot \left[\left[(DL_1 \cdot t_{1i_1}) \cdot l_{1i_1} \cdot \left(\frac{l_{1i_1}}{2} \right) \right] + \left[(DLw_1) \cdot h_{1i_1} \right] \cdot l_{1i_1} \cdot \left(\frac{l_{1i_1}}{2} \right) \right]$$

Nominal Overturing: $M_{1i_1} := M_{o1i_1} - M_{r1i_1}$

Tension at Pier Ends:
$$T_{1i_1} := \frac{M_{1i_1}}{l_{1i_1}}$$

ANCHOR BOLTS

Unit Shear (for bolts):
$$v_{b1} := \frac{\left[\sum_{i=1}^2 (\rho_i \cdot V_{a_i}) \right]}{L_{s1}}$$

1/2" bolt in 1 1/2" sill:
$$s_{0.5} := \frac{(650\text{-lb}) \cdot 1.6}{v_{b1}}$$

5/8" bolt in 1 1/2" sill:
$$s_{0.625} := \frac{(930\text{-lb}) \cdot 1.6}{v_{b1}}$$

SUMMARY, STORY 2

Reduction in shear walls due to height to width ratio less than 2:1

$$\text{ratio}_{i2} := \frac{l_{2i2}}{h_{2i2}} \quad r2 := \text{if}(2 \cdot \min(\text{ratio}) > 1.0, 1.0, 2 \cdot \min(\text{ratio})) \quad r2 = 1$$

Unit Shear

$$\frac{v_2}{r2} = 186 \cdot \text{plf}$$

SHEAR WALLS

Sheathing: 7/16", APA, Exp. 1
 Blocking: All Panel Edges
 Edge Nailing: 8d @ 6" o.c.
 Field Nailing: 8d @ 12" o.c.

Uplift

HOLD DOWN

Pier 1:	T2 ₁ = 537 lb	SIMPSON MST48
Pier 2:	T2 ₂ = ■ lb	
Pier 3:	T2 ₃ = ■ lb	
Pier 4:	T2 ₄ = ■ lb	
Pier 5:	T2 ₅ = ■ lb	
Pier 6:	T2 ₆ = ■ lb	
Pier 7:	T2 ₇ = ■ lb	
Pier 8:	T2 ₈ = ■ lb	

SUMMARY, STORY 1

Reduction in shear walls due to height to width ratio less than 2:1

$$\text{ratio}_{i1} := \frac{l_{1i1}}{h_{1i1}} \quad r1 := \text{if}(2 \cdot \min(\text{ratio}) > 1.0, 1.0, 2 \cdot \min(\text{ratio})) \quad r1 = 1$$

Unit Shear

$$\frac{v_1}{r1} = 177 \cdot \text{plf}$$

SHEAR WALLS

Sheathing: 7/16", APA, Exp. 1
 Blocking: All Panel Edges
 Edge Nailing: 8d @ 6" o.c.
 Field Nailing: 8d @ 12" o.c.

Uplift

HOLD DOWN

Pier 1:	T1 ₁ = 1047 lb	SIMPSON MST48
Pier 2:	T1 ₂ = -93 lb	NONE REQUIRED
Pier 3:	T1 ₃ = ■ lb	
Pier 4:	T1 ₄ = ■ lb	
Pier 5:	T1 ₅ = ■ lb	
Pier 6:	T1 ₆ = ■ lb	
Pier 7:	T1 ₇ = ■ lb	
Pier 8:	T1 ₈ = ■ lb	

SHEAR WALLS - LINE 2

STORY2		PIERS	Length	Height	Tributary
# Piers in Shear Line:	$n_2 := 1$ (n = 8 max)	1:	$l_{21} := 21 \cdot \text{ft}$	$h_{21} := 9 \cdot \text{ft}$	$t_{21} := 9 \cdot \text{ft}$
Story Shear:	$F_{a2} := 5.2 \cdot k$ (Allowable)	2:	$l_{22} := 0 \cdot \text{ft}$	$h_{22} := 0 \cdot \text{ft}$	$t_{22} := 0 \cdot \text{ft}$
Shear Attributed To Line:	$V_{a2} := 2.6 \cdot k$ (Allowable)	3:	$l_{23} := 0 \cdot \text{ft}$	$h_{23} := 0 \cdot \text{ft}$	$t_{23} := 0 \cdot \text{ft}$
Story DL:	$DL_2 := 15 \cdot \text{psf}$	4:	$l_{24} := 0 \cdot \text{ft}$	$h_{24} := 0 \cdot \text{ft}$	$t_{24} := 0 \cdot \text{ft}$
Wall DL:	$DLw_2 := 15 \cdot \text{psf}$	5:	$l_{25} := 0 \cdot \text{ft}$	$h_{25} := 0 \cdot \text{ft}$	$t_{25} := 0 \cdot \text{ft}$
Redundancy	$\rho_2 := 1$	6:	$l_{26} := 0 \cdot \text{ft}$	$h_{26} := 0 \cdot \text{ft}$	$t_{26} := 0 \cdot \text{ft}$
		7:	$l_{27} := 0 \cdot \text{ft}$	$h_{27} := 0 \cdot \text{ft}$	$t_{27} := 0 \cdot \text{ft}$
		8:	$l_{28} := 0 \cdot \text{ft}$	$h_{28} := 0 \cdot \text{ft}$	$t_{28} := 0 \cdot \text{ft}$

SHEAR CALCULATIONS

Unit Shear (for walls):
$$v_2 := \frac{\rho_2 \cdot V_{a2}}{\sum l_2}$$

OVERTURNING CALCULATIONS $i_2 := 1..n_2$

Overturning Moment: $Mo_{2i_2} := v_2 \cdot h_{2i_2} \cdot l_{2i_2}$ $Mo_2 = (23.4) \cdot k \cdot \text{ft}$

Resisting Moment:
$$Mr_{2i_2} := 0.6 \cdot \left[\left(DL_2 \cdot t_{2i_2} \right) \cdot l_{2i_2} \cdot \left(\frac{l_{2i_2}}{2} \right) \right] + \left[\left(DLw_2 \cdot h_{2i_2} \right) \cdot l_{2i_2} \cdot \left(\frac{l_{2i_2}}{2} \right) \right]$$

Nominal Overturning: $M_{2i_2} := Mo_{2i_2} - Mr_{2i_2}$

Tension at Pier Ends:
$$T_{2i_2} := \frac{M_{2i_2}}{l_{2i_2}}$$

STORY 1

			PIERS	Length	Height	Tributary
# Piers in Shear Line:	$n_1 := 1$	($n = 8$ max)	1:	$l_{11} := 36\text{-ft}$	$h_{11} := 10\text{-ft}$	$t_{11} := 4\text{-ft}$
Story Shear:	$F_{a1} := 2.4\text{-k}$	(Allowable)	2:	$l_{12} := 0\text{-ft}$	$h_{12} := 0\text{-ft}$	$t_{12} := 0\text{-ft}$
Shear Attributed To Line:	$V_{a1} := 1.2\text{-k}$	(Allowable)	3:	$l_{13} := 0\text{-ft}$	$h_{13} := 0\text{-ft}$	$t_{13} := 0\text{-ft}$
Story DL:	$DL_1 := 50\text{-psf}$		4:	$l_{14} := 0\text{-ft}$	$h_{14} := 0\text{-ft}$	$t_{14} := 0\text{-ft}$
Wall DL:	$DL_{w1} := 15\text{-psf}$		5:	$l_{15} := 0\text{-ft}$	$h_{15} := 0\text{-ft}$	$t_{15} := 0\text{-ft}$
Sill Plate Length:	$L_{s1} := 36\text{-ft}$		6:	$l_{16} := 0\text{-ft}$	$h_{16} := 0\text{-ft}$	$t_{16} := 0\text{-ft}$
Redundancy	$\rho_1 := 1$		7:	$l_{17} := 0\text{-ft}$	$h_{17} := 0\text{-ft}$	$t_{17} := 0\text{-ft}$
			8:	$l_{18} := 0\text{-ft}$	$h_{18} := 0\text{-ft}$	$t_{18} := 0\text{-ft}$

SHEAR CALCULATIONS

Unit Shear (for walls):
$$v_1 := \frac{(\rho_2 \cdot V_{a2} + \rho_1 \cdot V_{a1})}{\sum l_{1i}}$$

OVERTURNING CALCULATIONS $i1 := 1..n1$

Overturning Moment:
$$M_{o1i1} := \left[\frac{(\rho_2 \cdot V_{a2} + \rho_1 \cdot V_{a1}) \cdot h_{1i1}}{\sum l_{1i}} \right] \cdot l_{1i1}$$

Resisting Moment:
$$M_{r1i1} := 0.6 \cdot \left[\left[(DL_1 \cdot t_{1i1}) \cdot l_{1i1} \cdot \left(\frac{l_{1i1}}{2} \right) \right] + \left[[(DL_{w1}) \cdot h_{1i1}] \cdot l_{1i1} \cdot \left(\frac{l_{1i1}}{2} \right) \right] \right]$$

Nominal Overturning: $M_{1i1} := M_{o1i1} - M_{r1i1}$

Tension at Pier Ends:
$$T_{1i1} := \frac{M_{1i1}}{l_{1i1}}$$

ANCHOR BOLTS

Unit Shear (for bolts):
$$v_{b1} := \frac{\left[\sum_{i=1}^2 (\rho_i \cdot V_{ai}) \right]}{L_{s1}}$$

1/2" bolt in 1 1/2" sill:
$$s_{0.5} := \frac{(650 \cdot lb) \cdot 1.6}{v_{b1}}$$

5/8" bolt in 1 1/2" sill:
$$s_{0.625} := \frac{(930 \cdot lb) \cdot 1.6}{v_{b1}}$$

SUMMARY, STORY 2

Reduction in shear walls due to height to width ratio less than 2:1

$$\text{ratio}_2 := \frac{l_{2;2}}{h_{2;2}} \quad r_2 := \text{if}(2 \cdot \min(\text{ratio}) > 1.0, 1.0, 2 \cdot \min(\text{ratio})) \quad r_2 = 1$$

Unit Shear

$$\frac{V_2}{r_2} = 124 \cdot \text{plf}$$

Uplift

HOLD DOWN

Pier 1:	T2 ₁ = -587 lb	NONE REQUIRED
Pier 2:	T2 ₂ = 1 lb	
Pier 3:	T2 ₃ = 1 lb	
Pier 4:	T2 ₄ = 1 lb	
Pier 5:	T2 ₅ = 1 lb	
Pier 6:	T2 ₆ = 1 lb	
Pier 7:	T2 ₇ = 1 lb	
Pier 8:	T2 ₈ = 1 lb	

SHEAR WALLS

Sheathing: 7/16", APA, Exp. 1
 Blocking: All Panel Edges
 Edge Nailing: 8d @ 6" o.c.
 Field Nailing: 8d @ 12" o.c.

SUMMARY, STORY 1

Reduction in shear walls due to height to width ratio less than 2:1

$$\text{ratio}_1 := \frac{l_{1;1}}{h_{1;1}} \quad r_1 := \text{if}(2 \cdot \min(\text{ratio}) > 1.0, 1.0, 2 \cdot \min(\text{ratio})) \quad r_1 = 1$$

Unit Shear

$$\frac{V_1}{r_1} = 106 \cdot \text{plf}$$

Uplift

HOLD DOWN

Pier 1:	T1 ₁ = -2724 lb	NONE REQUIRED
Pier 2:	T1 ₂ = 1 lb	
Pier 3:	T1 ₃ = 1 lb	
Pier 4:	T1 ₄ = 1 lb	
Pier 5:	T1 ₅ = 1 lb	
Pier 6:	T1 ₆ = 1 lb	
Pier 7:	T1 ₇ = 1 lb	
Pier 8:	T1 ₈ = 1 lb	

SHEAR WALLS

Sheathing: 7/16", APA, Exp. 1
 Blocking: All Panel Edges
 Edge Nailing: 8d @ 6" o.c.
 Field Nailing: 8d @ 12" o.c.

ANCHOR BOLTS

1/2" A.Bolts

5/8" A.Bolts

$$s_{0.5} = 118 \cdot \text{in}$$

$$s_{0.625} = 169 \cdot \text{in}$$

USE:

5/8" dia. x 10" J-bolts

Spacing = 32" o.c.

SHEAR WALLS - LINE A'

STORY2		PIERS	Length	Height	Tributary
# Piers in Shear Line:	$n_2 := 1$ (n = 8 max)	1:	$l_{21} := 6.5\text{-ft}$	$h_{21} := 9\text{-ft}$	$t_{21} := 1\text{-ft}$
Story Shear:	$F_{a2} := 5.2\text{-k}$ (Allowable)	2:	$l_{22} := 0\text{-ft}$	$h_{22} := 0\text{-ft}$	$t_{22} := 0\text{-ft}$
Shear Attributed To Line:	$V_{a2} := 2.6\text{-k}$ (Allowable)	3:	$l_{23} := 0\text{-ft}$	$h_{23} := 0\text{-ft}$	$t_{23} := 0\text{-ft}$
Story DL:	$DL_2 := 15\text{-psf}$	4:	$l_{24} := 0\text{-ft}$	$h_{24} := 0\text{-ft}$	$t_{24} := 0\text{-ft}$
Wall DL:	$DLw_2 := 15\text{-psf}$	5:	$l_{25} := 0\text{-ft}$	$h_{25} := 0\text{-ft}$	$t_{25} := 0\text{-ft}$
Redundancy	$\rho_2 := 1$	6:	$l_{26} := 0\text{-ft}$	$h_{26} := 0\text{-ft}$	$t_{26} := 0\text{-ft}$
		7:	$l_{27} := 0\text{-ft}$	$h_{27} := 0\text{-ft}$	$t_{27} := 0\text{-ft}$
		8:	$l_{28} := 0\text{-ft}$	$h_{28} := 0\text{-ft}$	$t_{28} := 0\text{-ft}$

SHEAR CALCULATIONS

Unit Shear (for walls):
$$v_2 := \frac{\rho_2 \cdot V_{a2}}{\sum l_2}$$

OVERTURNING CALCULATIONS $i_2 := 1..n_2$

Overturning Moment:
$$M_{o2i_2} := v_2 \cdot h_{2i_2} \cdot l_{2i_2} \qquad M_{o2} = (23.4) \cdot \text{k} \cdot \text{ft}$$

Resisting Moment:
$$M_{r2i_2} := 0.6 \cdot \left[\left(DL_2 \cdot t_{2i_2} \right) \cdot l_{2i_2} \cdot \left(\frac{l_{2i_2}}{2} \right) \right] + \left[\left(DLw_2 \cdot h_{2i_2} \right) \cdot l_{2i_2} \cdot \left(\frac{l_{2i_2}}{2} \right) \right]$$

Nominal Overturning:
$$M_{2i_2} := M_{o2i_2} - M_{r2i_2}$$

Tension at Pier Ends:
$$T_{2i_2} := \frac{M_{2i_2}}{l_{2i_2}}$$

STORY 1

			PIERS	Length	Height	Tributary
# Piers in Shear Line:	$n1 := 1$	($n = 8$ max)	1:	$l1_1 := 18\text{-ft}$	$h1_1 := 10\text{-ft}$	$t1_1 := 1\text{-ft}$
Story Shear:	$Fa_1 := 2.4\text{-k}$	(Allowable)	2:	$l1_2 := 0\text{-ft}$	$h1_2 := 0\text{-ft}$	$t1_2 := 0\text{-ft}$
Shear Attributed To Line:	$Va_1 := 1.2\text{-k}$	(Allowable)	3:	$l1_3 := 0\text{-ft}$	$h1_3 := 0\text{-ft}$	$t1_3 := 0\text{-ft}$
Story DL:	$DL_1 := 50\text{-psf}$		4:	$l1_4 := 0\text{-ft}$	$h1_4 := 0\text{-ft}$	$t1_4 := 0\text{-ft}$
Wall DL:	$DLw_1 := 15\text{-psf}$		5:	$l1_5 := 0\text{-ft}$	$h1_5 := 0\text{-ft}$	$t1_5 := 0\text{-ft}$
Sill Plate Length:	$Ls_1 := 18\text{-ft}$		6:	$l1_6 := 0\text{-ft}$	$h1_6 := 0\text{-ft}$	$t1_6 := 0\text{-ft}$
Redundancy	$\rho_1 := 1$		7:	$l1_7 := 0\text{-ft}$	$h1_7 := 0\text{-ft}$	$t1_7 := 0\text{-ft}$
			8:	$l1_8 := 0\text{-ft}$	$h1_8 := 0\text{-ft}$	$t1_8 := 0\text{-ft}$

SUBTRACT OPENINGS BELOW

SHEAR CALCULATIONS

Unit Shear (for walls):
$$v_1 := \frac{(\rho_2 \cdot Va_2 + \rho_1 \cdot Va_1)}{\sum l1}$$

OVERTURNING CALCULATIONS $i1 := 1..n1$

Overturing Moment:
$$Mo1_{i1} := \left[\frac{(\rho_2 \cdot Va_2 + \rho_1 \cdot Va_1) \cdot h1_{i1}}{\sum l1} \right] \cdot l1_{i1}$$

Resisting Moment:
$$Mr1_{i1} := 0.6 \cdot \left[\left[(DL_1 \cdot t1_{i1}) \cdot l1_{i1} \cdot \left(\frac{l1_{i1}}{2} \right) \right] + \left[[(DLw_1) \cdot h1_{i1}] \cdot l1_{i1} \cdot \left(\frac{l1_{i1}}{2} \right) \right] \right]$$

Nominal Overturing: $M1_{i1} := Mo1_{i1} - Mr1_{i1}$

Tension at Pier Ends:
$$T1_{i1} := \frac{M1_{i1}}{l1_{i1}}$$

ANCHOR BOLTS

Unit Shear (for bolts):
$$vb_1 := \frac{\left[\sum_{i=1}^2 (\rho_i \cdot Va_i) \right]}{Ls_1}$$

1/2" bolt in 1 1/2" sill:
$$s_{0.5} := \frac{(650 \cdot lb) \cdot 1.6}{vb_1}$$

5/8" bolt in 1 1/2" sill:
$$s_{0.625} := \frac{(930 \cdot lb) \cdot 1.6}{vb_1}$$

SUMMARY, STORY 2

Reduction in shear walls due to height to width ratio less than 2:1

SUBTRACT OPENINGS

$$\text{ratio}_{i2} := \frac{l_{2i2}}{h_{2i2}} \quad r2 := \text{if}(2 \cdot \min(\text{ratio}) > 1.0, 1.0, 2 \cdot \min(\text{ratio})) \quad r2 = 1 \quad t2 := \frac{(18 - 1 \cdot 2.5)}{18} \quad t2 = 0.86$$

Unit Shear

$$\frac{v_2}{r2 \cdot t2} = 465 \cdot \text{plf}$$

SHEAR WALLS

Sheathing: 7/16", APA, Exp. 1
 Blocking: All Panel Edges
 Edge Nailing: 8d @ 3" o.c.
 Field Nailing: 8d @ 12" o.c.

Uplift

HOLD DOWN

Pier 1:	T2 ₁ = 3308 lb	SIMPSON MST48
Pier 2:	T2 ₂ = 1 lb	
Pier 3:	T2 ₃ = 1 lb	
Pier 4:	T2 ₄ = 1 lb	
Pier 5:	T2 ₅ = 1 lb	
Pier 6:	T2 ₆ = 1 lb	
Pier 7:	T2 ₇ = 1 lb	
Pier 8:	T2 ₈ = 1 lb	

SUMMARY, STORY 1

Reduction in shear walls due to height to width ratio less than 2:1

$$\text{ratio}_{i1} := \frac{l_{1i1}}{h_{1i1}} \quad r1 := \text{if}(2 \cdot \min(\text{ratio}) > 1.0, 1.0, 2 \cdot \min(\text{ratio})) \quad r1 = 1$$

Unit Shear

$$\frac{v_1}{r1} = 211 \cdot \text{plf}$$

SHEAR WALLS

Sheathing: 7/16", APA, Exp. 1
 Blocking: All Panel Edges
 Edge Nailing: 8d @ 6" o.c.
 Field Nailing: 8d @ 12" o.c.

Uplift

HOLD DOWN

Pier 1:	T1 ₁ = 1031 lb	SIMPSON MST48
Pier 2:	T1 ₂ = 1 lb	
Pier 3:	T1 ₃ = 1 lb	
Pier 4:	T1 ₄ = 1 lb	
Pier 5:	T1 ₅ = 1 lb	
Pier 6:	T1 ₆ = 1 lb	
Pier 7:	T1 ₇ = 1 lb	
Pier 8:	T1 ₈ = 1 lb	

SHEAR WALLS - LINE C'

STORY2		PIERS	Length	Height	Tributary
# Piers in Shear Line:	$n_2 := 1$ (n = 8 max)	1:	$l_{21} := 5\text{-ft}$	$h_{21} := 9\text{-ft}$	$t_{21} := 1\text{-ft}$
Story Shear:	$F_{a2} := 5.2\cdot k$ (Allowable)	2:	$l_{22} := 0\text{-ft}$	$h_{22} := 0\text{-ft}$	$t_{22} := 0\text{-ft}$
Shear Attributed To Line:	$V_{a2} := 2.6\cdot k$ (Allowable)	3:	$l_{23} := 0\text{-ft}$	$h_{23} := 0\text{-ft}$	$t_{23} := 0\text{-ft}$
Story DL:	$DL_2 := 15\text{-psf}$	4:	$l_{24} := 0\text{-ft}$	$h_{24} := 0\text{-ft}$	$t_{24} := 0\text{-ft}$
Wall DL:	$DLw_2 := 15\text{-psf}$	5:	$l_{25} := 0\text{-ft}$	$h_{25} := 0\text{-ft}$	$t_{25} := 0\text{-ft}$
Redundancy	$\rho_2 := 1$	6:	$l_{26} := 0\text{-ft}$	$h_{26} := 0\text{-ft}$	$t_{26} := 0\text{-ft}$
		7:	$l_{27} := 0\text{-ft}$	$h_{27} := 0\text{-ft}$	$t_{27} := 0\text{-ft}$
		8:	$l_{28} := 0\text{-ft}$	$h_{28} := 0\text{-ft}$	$t_{28} := 0\text{-ft}$

SHEAR CALCULATIONS

Unit Shear (for walls):
$$v_2 := \frac{\rho_2 \cdot V_{a2}}{\sum l_2}$$

OVERTURNING CALCULATIONS $i_2 := 1..n_2$

Overturning Moment: $Mo_{2i_2} := v_2 \cdot h_{2i_2} \cdot l_{2i_2}$ $Mo_2 = (23.4) \cdot k \cdot ft$

Resisting Moment:
$$Mr_{2i_2} := 0.6 \cdot \left[\left[(DL_2 \cdot t_{2i_2}) \cdot l_{2i_2} \cdot \left(\frac{l_{2i_2}}{2} \right) \right] + \left[(DLw_2 \cdot h_{2i_2}) \cdot l_{2i_2} \cdot \left(\frac{l_{2i_2}}{2} \right) \right] \right]$$

Nominal Overturning: $M_{2i_2} := Mo_{2i_2} - Mr_{2i_2}$

Tension at Pier Ends:
$$T_{2i_2} := \frac{M_{2i_2}}{l_{2i_2}}$$

STORY 1

			PIERS	Length	Height	Tributary
# Piers in Shear Line:	$n_1 := 1$	($n = 8$ max)	1:	$l_{11} := 9\text{-ft}$	$h_{11} := 10\text{-ft}$	$t_{11} := 1\text{-ft}$
Story Shear:	$F_{a1} := 2.4\text{-k}$	(Allowable)	2:	$l_{12} := 0\text{-ft}$	$h_{12} := 0\text{-ft}$	$t_{12} := 0\text{-ft}$
Shear Attributed To Line:	$V_{a1} := 1.2\text{-k}$	(Allowable)	3:	$l_{13} := 0\text{-ft}$	$h_{13} := 0\text{-ft}$	$t_{13} := 0\text{-ft}$
Story DL:	$DL_1 := 50\text{-psf}$		4:	$l_{14} := 0\text{-ft}$	$h_{14} := 0\text{-ft}$	$t_{14} := 0\text{-ft}$
Wall DL:	$DL_{w1} := 15\text{-psf}$		5:	$l_{15} := 0\text{-ft}$	$h_{15} := 0\text{-ft}$	$t_{15} := 0\text{-ft}$
Sill Plate Length:	$L_{s1} := 9\text{-ft}$		6:	$l_{16} := 0\text{-ft}$	$h_{16} := 0\text{-ft}$	$t_{16} := 0\text{-ft}$
Redundancy	$\rho_1 := 1$		7:	$l_{17} := 0\text{-ft}$	$h_{17} := 0\text{-ft}$	$t_{17} := 0\text{-ft}$
			8:	$l_{18} := 0\text{-ft}$	$h_{18} := 0\text{-ft}$	$t_{18} := 0\text{-ft}$

SHEAR CALCULATIONS

Unit Shear (for walls):
$$v_1 := \frac{(\rho_2 \cdot V_{a2} + \rho_1 \cdot V_{a1})}{\sum l_{1i}}$$

OVERTURNING CALCULATIONS $i1 := 1..n1$

Overturing Moment:
$$M_{o1i1} := \left[\frac{(\rho_2 \cdot V_{a2} + \rho_1 \cdot V_{a1}) \cdot h_{1i1}}{\sum l_{1i}} \right] \cdot l_{1i1}$$

Resisting Moment:
$$M_{r1i1} := 0.6 \cdot \left[\left[(DL_1 \cdot t_{1i1}) \cdot l_{1i1} \cdot \left(\frac{l_{1i1}}{2} \right) \right] + \left[(DL_{w1}) \cdot h_{1i1} \cdot l_{1i1} \cdot \left(\frac{l_{1i1}}{2} \right) \right] \right]$$

Nominal Overturing:
$$M_{1i1} := M_{o1i1} - M_{r1i1}$$

Tension at Pier Ends:
$$T_{1i1} := \frac{M_{1i1}}{l_{1i1}}$$

ANCHOR BOLTS

Unit Shear (for bolts):
$$v_{b1} := \frac{\left[\sum_{i=1}^2 (\rho_i \cdot V_{a_i}) \right]}{L_{s1}}$$

1/2" bolt in 1 1/2" sill:
$$s_{0.5} := \frac{(650 \cdot \text{lb}) \cdot 1.6}{v_{b1}}$$

5/8" bolt in 1 1/2" sill:
$$s_{0.625} := \frac{(930 \cdot \text{lb}) \cdot 1.6}{v_{b1}}$$

SUMMARY, STORY 2

Reduction in shear walls due to height to width ratio less than 2:1

$$\text{ratio}_{i2} := \frac{l_{2i2}}{h_{2i2}} \quad r2 := \text{if}(2 \cdot \min(\text{ratio}) > 1.0, 1.0, 2 \cdot \min(\text{ratio})) \quad r2 = 1$$

Unit Shear

$$\frac{v_2}{r2} = 520 \cdot \text{plf}$$

SHEAR WALLS

Sheathing: 7/16", APA, Exp. 1
 Blocking: All Panel Edges
 Edge Nailing: 8d @ 2" o.c.
 Field Nailing: 8d @ 12" o.c.

Uplift

HOLD DOWN

Pier 1:	T ₂₁ = 4455 lb	SIMPSON MST72
Pier 2:	T ₂₂ = ■ lb	
Pier 3:	T ₂₃ = ■ lb	
Pier 4:	T ₂₄ = ■ lb	
Pier 5:	T ₂₅ = ■ lb	
Pier 6:	T ₂₆ = ■ lb	
Pier 7:	T ₂₇ = ■ lb	
Pier 8:	T ₂₈ = ■ lb	

SUMMARY, STORY 1

Reduction in shear walls due to height to width ratio less than 2:1

$$\text{ratio}_{i1} := \frac{l_{1i1}}{h_{1i1}} \quad r1 := \text{if}(2 \cdot \min(\text{ratio}) > 1.0, 1.0, 2 \cdot \min(\text{ratio})) \quad r1 = 1$$

Unit Shear

$$\frac{v_1}{r1} = 422 \cdot \text{plf}$$

SHEAR WALLS

Sheathing: 7/16", APA, Exp. 1
 Blocking: All Panel Edges
 Edge Nailing: 8d @ 3" o.c.
 Field Nailing: 8d @ 12" o.c.

Uplift

HOLD DOWN

Pier 1:	T ₁₁ = 3682 lb	SIMPSON MST48
Pier 2:	T ₁₂ = ■ lb	
Pier 3:	T ₁₃ = ■ lb	
Pier 4:	T ₁₄ = ■ lb	
Pier 5:	T ₁₅ = ■ lb	
Pier 6:	T ₁₆ = ■ lb	
Pier 7:	T ₁₇ = ■ lb	
Pier 8:	T ₁₈ = ■ lb	

Seismic Base Shear (full structure)

This worksheet calculates the Seismic Loads applied to the building's main lateral load resisting system per ASCE 7-10, Chapters 11 and 12.

Number of Stories

$$N_{ww} = 3$$

$$x = 1 - N$$

Parapet

$$h_p = 0 \text{ ft}$$

$$D_p = 0 \text{ psf}$$

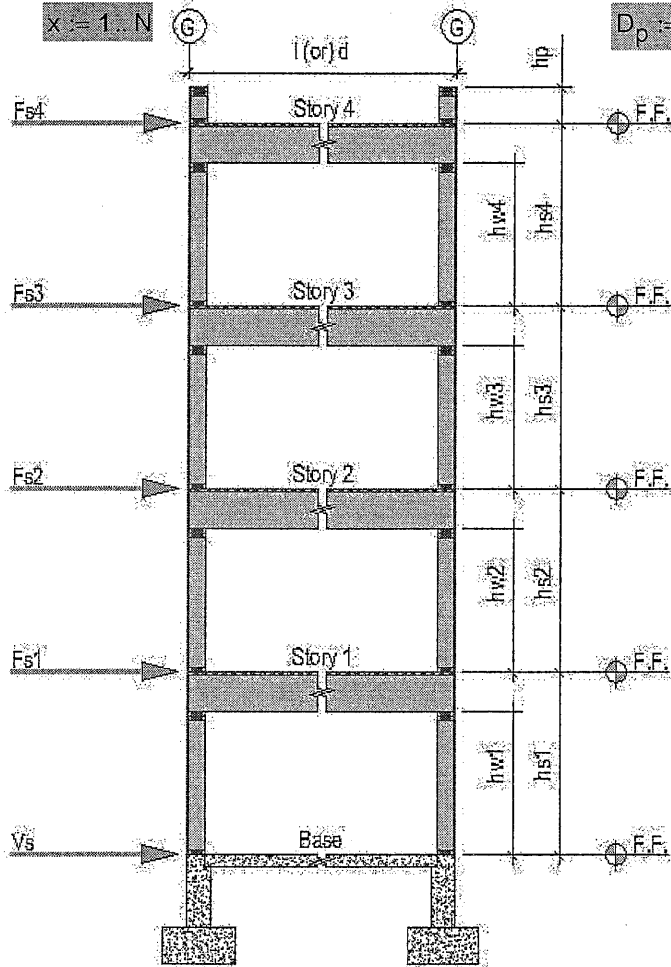

Story 4

$$l_4 = 0 \text{ ft}$$

$$d_4 = 0 \text{ ft}$$

$$h_{s4} = 0 \text{ ft}$$

$$D_4 = 0 \text{ psf}$$

$$D_{W4} = 0 \text{ psf}$$

Story 3

$$l_3 = 40 \text{ ft}$$

$$d_3 = 24.5 \text{ ft}$$

$$h_{s3} = 9 \text{ ft}$$

$$D_3 = (15 + 58) \text{ psf}$$

$$D_{W3} = 15 \text{ psf}$$

Story 2

$$l_2 = 40 \text{ ft}$$

$$d_2 = 24.5 \text{ ft}$$

$$h_{s2} = 10 \text{ ft}$$

$$D_2 = 50 \text{ psf}$$

$$D_{W2} = 15 \text{ psf}$$

Story 1

$$l_1 = 40 \text{ ft}$$

$$d_1 = 24.5 \text{ ft}$$

$$h_{s1} = 8 \text{ ft}$$

$$D_1 = 50 \text{ psf}$$

$$D_{W1} = 15 \text{ psf}$$

30% snow

Wood Shear Walls:

$$R_{ww} = 6.5$$

(Table 12.2-1)

Determine the MCE SRA Parameters per Section 11.4:

Site Class:	SC := "D"	(Table 20.3-1)
<u>@ Short Periods</u>	<u>@ 1-second Period</u>	
S _s := 0.898	S ₁ := 0.304	(Figures 22-1 thr. 22-14)
S _{ds} := 0.683	S _{d1} := 0.363	(Equations 11.4-3 & 11.4-4)

Determine the Seismic Design Category per Section 11.6:

Occupancy Category:	OC := 2	(IBC Table 1604.5)
I _e := 1.0		(Table 11.5-1)
SDC = "D"		(Table 11.6-1)

Calculate the Effective Seismic Weight per Section 12.7.2:

Diaphragms:	wd _x := D _x · l _x · d _x	h _{sN+1} := 2 · h _{sN+1}
Walls:	ww _x := $\left(D_{w_x} \cdot \frac{h_{s_x}}{2} + D_{w_{x+1}} \cdot \frac{h_{s_{x+1}}}{2} \right)$	
Story Weight:	w _x := wd _x + ww _x · (2 · l _x + 2 · d _x)	h _{sN+1} := 0.5 · h _{sN+1}
Total Weight:	W _{ww} := ∑ w	
	W = 214.0 · kip	

Calculate the Approximate Fundamental Period per Section 12.7.2:

h _n := ∑ _{i=1} ^{N+1} $\frac{h_{s_i}}{ft}$	(Section 12.8.2.1)
C _t := 0.02	(Table 12.8-2)
X := 0.75	(Table 12.8-2)
T _a := C _t · h _n ^X	(Equation 12.8-7)

Calculate the Fundamental Period per Section 12.7.2:

$$C_U := 1.5 \quad (\text{Table 12.8-1})$$

$$T_m := C_U \cdot T_a \quad (\text{Section 12.8.2})$$

$$T = 0.355$$

Determine the Long-period Transition Period per Section 11.4.5:

$$T_L := 8.0 \quad (\text{Figure 22-15})$$

Calculate the Seismic Response Coefficient per Section 12.8.1.1:

$$C_S := \frac{S_{ds} \cdot I_e}{R} \quad (\text{Equation 12.8-2})$$

$$C_{smin} := \begin{cases} \frac{0.5 \cdot S_1 \cdot I_e}{R} & \text{if } S_1 > 0.60 \\ 0.01 & \text{otherwise} \end{cases} \quad (\text{Equations 12.8-5 \& 12.8-6})$$

$$C_{smax} := \begin{cases} \frac{S_{d1} \cdot I_e}{R \cdot T} & \text{if } T \leq T_L \\ \frac{S_{d1} \cdot I_e \cdot T_L}{R \cdot T^2} & \text{if } T > T_L \end{cases} \quad (\text{Equations 12.8-3 \& 12.8-4})$$

$$C_{sv} := \begin{cases} C_{smin} & \text{if } C_S < C_{smin} \\ C_{smax} & \text{if } C_S > C_{smax} \\ C_S & \text{otherwise} \end{cases}$$

$$C_S = 0.105$$

Calculate the Seismic Base Shear per Section 12.8.1:

$$V_S := C_S \cdot W \quad (\text{Equation 12.8-1})$$

$$V_S = 22.5 \cdot \text{kip} \quad \text{STRENGTH}$$

$$\frac{V_S}{1.4} = 16.1 \cdot \text{kip} \quad \text{ALLOWABLE}$$

Vertically Distribute the Seismic Base Shear per Section 12.8.3:

$$k1 := \begin{pmatrix} 1 \\ 2 \end{pmatrix}$$

$$t1 := \begin{pmatrix} 0.5 \\ 2.5 \end{pmatrix}$$

$$k_w := \begin{cases} 1.0 & \text{if } T < 0.5 \\ \text{interp}(t1, k1, T) & \text{if } 0.5 \leq T \leq 2.5 \\ 2.0 & \text{if } T > 2.5 \end{cases}$$

$$C_{Vx} := \frac{w_x \cdot \left(\sum_{i=1}^x \frac{h_{s_i}}{ft} \right)^k}{\sum_{i=1}^N \left[w_i \cdot \left(\sum_{j=1}^i \frac{h_{s_j}}{ft} \right)^k \right]}$$

(Equation 12.8-12)

$$F_{S_x} := C_{V_x} \cdot V_s$$

(Equation 12.8-11)

	STRENGTH	ALLOWABLE
(Story 4)	$F_{S_4} = 1 \cdot \text{kip}$	$0.71 F_{S_4} = 0.71 \cdot \text{kip}$
(Story 3)	$F_{S_3} = 12.5 \cdot \text{kip}$	$0.71 F_{S_3} = 8.8 \cdot \text{kip}$
(Story 2)	$F_{S_2} = 7.0 \cdot \text{kip}$	$0.71 F_{S_2} = 5.0 \cdot \text{kip}$
(Story 1)	$F_{S_1} = 3.1 \cdot \text{kip}$	$0.71 F_{S_1} = 2.2 \cdot \text{kip}$

Calculate the Diaphragm Design Force (perpendicular to L) per Section 12.10.1.1:

$$F_{psl_x} := \frac{\sum_{i=x}^N F_{S_i}}{\sum_{i=x}^N w_i} \cdot \left(\frac{wd_x}{l_x} + 2 \cdot ww_x \right)$$

(Equation 12.10-1)

$$F_{psl_{min_x}} := 0.2 \cdot S_{ds} \cdot l_e \cdot \left(\frac{wd_x}{l_x} + 2 \cdot ww_x \right)$$

(Section 12.10.1.1)

$$F_{psl_{max_x}} := 0.4 \cdot S_{ds} \cdot l_e \cdot \left(\frac{wd_x}{l_x} + 2 \cdot ww_x \right)$$

(Section 12.10.1.1)

$$F_{psl_x} := \begin{cases} F_{pslmin_x} & \text{if } F_{psl_x} < F_{pslmin_x} \\ F_{pslmax_x} & \text{if } F_{psl_x} > F_{pslmax_x} \\ F_{psl_x} & \text{otherwise} \end{cases}$$

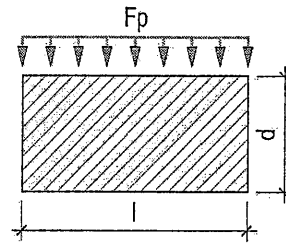

$$F_{psl_4} = 1 \cdot p \cdot l \quad (\text{Story 4})$$

$$F_{psl_3} = 298.7 \cdot p \cdot l \quad (\text{Story 3})$$

$$F_{psl_2} = 206.3 \cdot p \cdot l \quad (\text{Story 2})$$

$$F_{psl_1} = 204.2 \cdot p \cdot l \quad (\text{Story 1})$$

Calculate the Diaphragm Design Force (perpendicular to D) per Section 12.10.1.1:

$$F_{psd_x} := \frac{\sum_{i=x}^N F_{s_i}}{\sum_{i=x}^N w_i} \cdot \left(\frac{w d_x}{d_x} + 2 \cdot w w_x \right) \quad (\text{Equation 12.10-1})$$

$$F_{psdmin_x} := 0.2 \cdot S_{ds} \cdot I_e \cdot \left(\frac{w d_x}{d_x} + 2 \cdot w w_x \right) \quad (\text{Section 12.10.1.1})$$

$$F_{psdmax_x} := 0.4 \cdot S_{ds} \cdot I_e \cdot \left(\frac{w d_x}{d_x} + 2 \cdot w w_x \right) \quad (\text{Section 12.10.1.1})$$

$$F_{psd_x} := \begin{cases} F_{psdmin_x} & \text{if } F_{psd_x} < F_{psdmin_x} \\ F_{psdmax_x} & \text{if } F_{psd_x} > F_{psdmax_x} \\ F_{psd_x} & \text{otherwise} \end{cases}$$

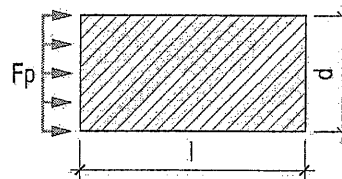

$$F_{psd_4} = 1 \cdot p \cdot l \quad (\text{Story 4})$$

$$F_{psd_3} = 474.4 \cdot p \cdot l \quad (\text{Story 3})$$

$$F_{psd_2} = 312.1 \cdot p \cdot l \quad (\text{Story 2})$$

$$F_{psd_1} = 310.1 \cdot p \cdot l \quad (\text{Story 1})$$

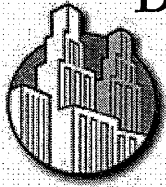

DYNAMIC STRUCTURES

1887 North 1120 West
 Provo, UT 84604
 Tel: (801) 356-1140

JOB _____

SHEET NO _____ OF _____

CALCULATED BY _____ DATE _____

GLOBAL OVERTURNING

SAFER DIRECTION WILL CONTROL

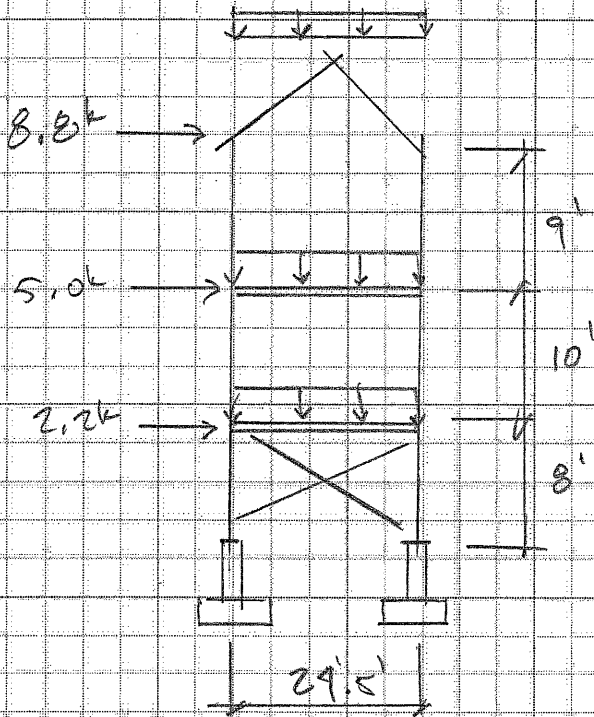

OVERTURNING (ASA)

$$OTM = 0.7 \left[(8.8k)(27') + 5.0k(10') + 2.2k(8') \right] = 291.6 \text{ k-ft}$$

RIGHTING FORCE (ASD)

$$RM = 0.6(15 \text{ PSF} + 50 \text{ PSF} + 50 \text{ PSF})(29.5')(40') \left(\frac{29.5'}{2} \right) / 1000 = 828.3 \text{ k-ft}$$

BUILDING STABLE

$$ASD \text{ FORCE ON FOOTING} = 291.2 \text{ k-ft} / 29.5' = 9.9 \text{ k}$$

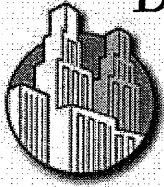

DYNAMIC STRUCTURES

1887 North 1120 West
Provo, UT 84604
Tel: (801) 356-1140

JOB _____

SHEET NO _____ OF _____

CALCULATED BY _____ DATE _____

FOUNDATIONS

WORST CASE TRIBUTARY TO COLUMN

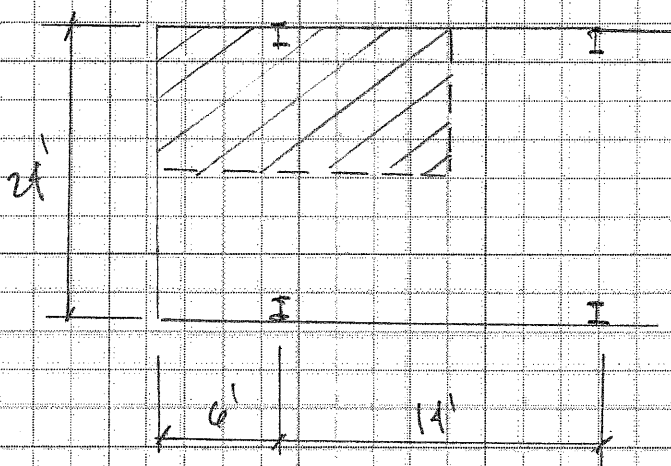

$$\begin{aligned} \text{AREA} &= 12' (6' + 7') \\ &= 156 \text{ FT}^2 \end{aligned}$$

$$P = \left[\frac{15 \text{ PSF} + 192 \text{ PSF} + 2(50 \text{ PSF} + 40 \text{ PSF})}{1000} \right] (156 \text{ FT}^2) = 6 \text{ k}$$

ADD 10^k FROM OVERTURNING

$$6 \text{ k} + 10 \text{ k} = 16 \text{ k}$$

ALLOWABLE SOIL PRESSURE = 2600 PSF

$$\left(\frac{16 \text{ k}}{2.6 \text{ k/ft}^2} \right)^{1/2} = 5.2' \quad \text{USE } \underline{\underline{6' \times 6' \times 14'}}$$

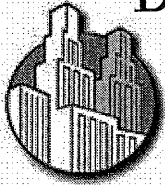

DYNAMIC STRUCTURES

1887 North 1120 West
Provo, UT 84604
Tel: (801) 356-1140

JOB _____

SHEET NO _____ OF _____

CALCULATED BY _____ DATE _____

CROSS BRACING BETWEEN LOWER LEVEL
AND FOUNDATION

- (3) BRACES IN SHORT DIRECTION
- (2) BRACES IN LONG DIRECTION,

LONG DIRECTION BRACES WILL CONTROL

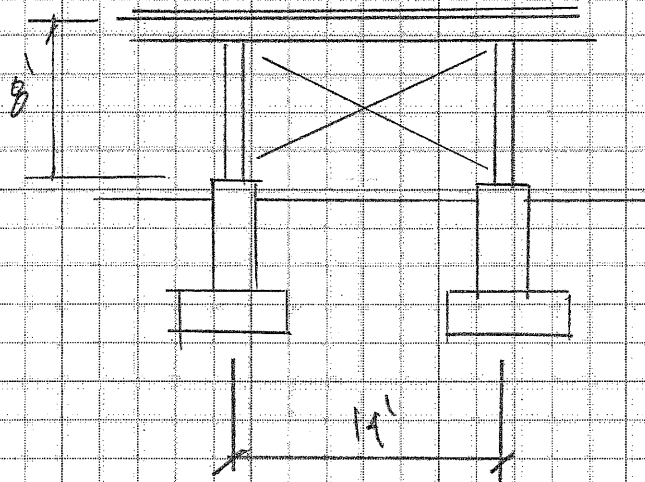

UPPER LEVEL BASE
SHARE FOR $R=6.5$
 $= 16k$

R FOR ORDINARY STEEL
CONCENTRICALLY
BRACED FRAMES $= 3.25$

$$V = 16k \left(\frac{6.5}{3.25} \right) = 32k$$

$$32k / 2 \text{ BAYS} = 16k \text{ PER BAY}$$

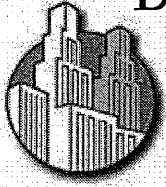

DYNAMIC STRUCTURES

1887 North 1120 West
Provo, UT 84604
Tel: (801) 356-1140

JOB _____

SHEET NO _____ OF _____

CALCULATED BY _____ DATE _____

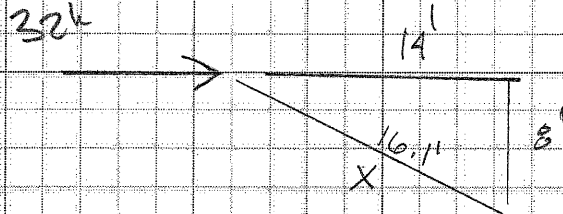

FORCE IN ROD

$$\frac{X}{16.1'} = \frac{32k}{14'} \quad X = 36.8k$$

$$A_{\text{rod}} = \frac{36.8k}{0.9 (36ksf)} = 1.14 \text{ in}^2$$

USE 1 1/4" DIA GR 36 ROD, $A = 1.23 \text{ in}^2$

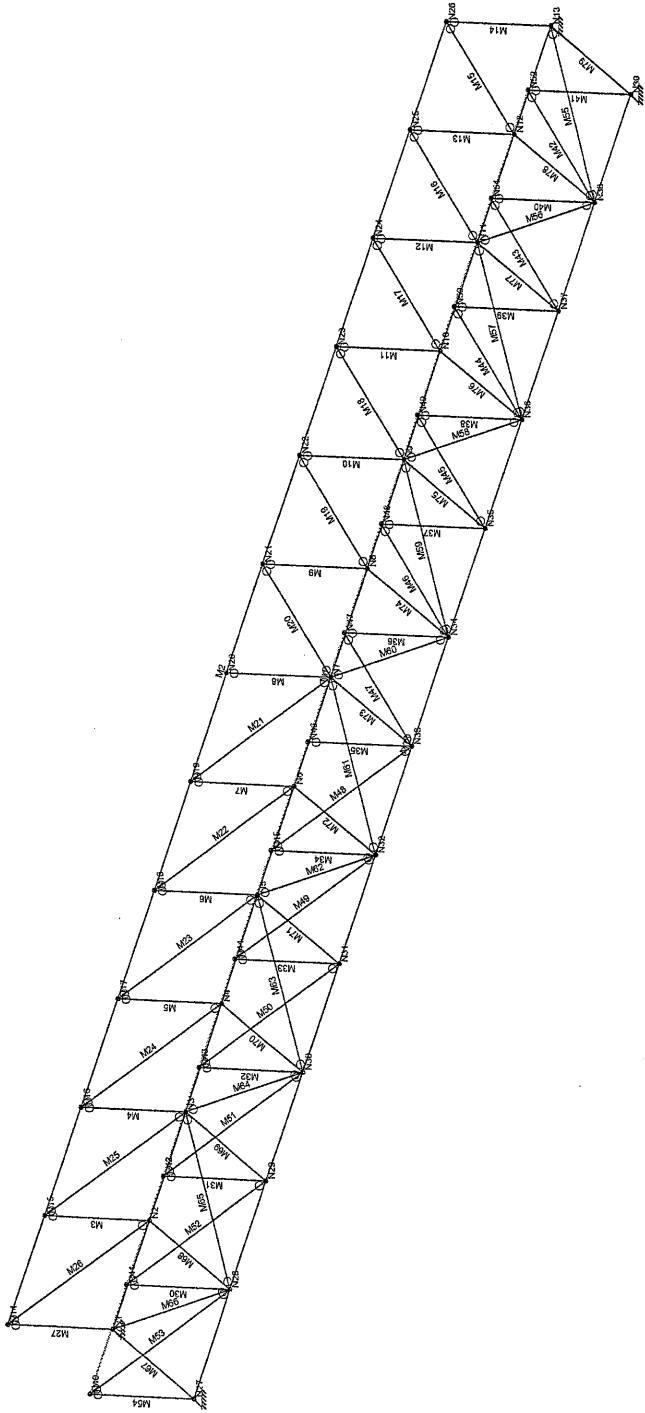

ACCESS RAMP / BRIDGE
 48' MAX. SPAN





Company :
 Designer :
 Job Number :
 Model Name :

July 13, 2017
 4:22 PM
 Checked By: _____

(Global) Model Settings

Display Sections for Member Calcs	5
Max Internal Sections for Member Calcs	97
Include Shear Deformation?	Yes
Increase Nailing Capacity for Wind?	Yes
Include Warping?	Yes
Trans Load Btwn Intersecting Wood Wall?	Yes
Area Load Mesh (in^2)	144
Merge Tolerance (in)	.12
P-Delta Analysis Tolerance	0.50%
Include P-Delta for Walls?	Yes
Automatically Iterate Stiffness for Walls?	Yes
Max Iterations for Wall Stiffness	3
Gravity Acceleration (ft/sec^2)	32.2
Wall Mesh Size (in)	24
Eigensolution Convergence Tol. (1.E-)	4
Vertical Axis	Y
Global Member Orientation Plane	XZ
Static Solver	Sparse Accelerated
Dynamic Solver	Accelerated Solver

Hot Rolled Steel Code	AISC 14th(360-10): LRFD
Adjust Stiffness?	Yes(Iterative)
RISAConnection Code	AISC 14th(360-10): LRFD
Cold Formed Steel Code	None
Wood Code	None
Wood Temperature	< 100F
Concrete Code	None
Masonry Code	None
Aluminum Code	None - Building

Number of Shear Regions	4
Region Spacing Increment (in)	4
Biaxial Column Method	Exact Integration
Parme Beta Factor (PCA)	.65
Concrete Stress Block	Rectangular
Use Cracked Sections?	Yes
Use Cracked Sections Slab?	Yes
Bad Framing Warnings?	No
Unused Force Warnings?	Yes
Min 1 Bar Diam. Spacing?	No
Concrete Rebar Set	REBAR SET ASTMA615
Min % Steel for Column	1
Max % Steel for Column	8

(Global) Model Settings, Continued

Seismic Code	None
Seismic Base Elevation (ft)	Not Entered
Add Base Weight?	Yes
Ct X	.02
Ct Z	.02
T X (sec)	Not Entered
T Z (sec)	Not Entered
R X	3
R Z	3

Hot Rolled Steel Properties

	Label	E [ksi]	G [ksi]	Nu	Therm (1/E...Density[k/ft...	Yield[ksi]	Ry	Fu[ksi]	Rt	
1	A992	29000	11154	.3	.65	.49	50	1.1	65	1.1
2	A36 Gr.36	29000	11154	.3	.65	.49	36	1.5	58	1.2
3	A572 Gr.50	29000	11154	.3	.65	.49	50	1.1	65	1.1
4	A500 Gr.B RND	29000	11154	.3	.65	.527	42	1.4	58	1.3
5	A500 Gr.B Rect	29000	11154	.3	.65	.527	46	1.4	58	1.3
6	A53 Gr.B	29000	11154	.3	.65	.49	35	1.6	60	1.2
7	A1085	29000	11154	.3	.65	.49	50	1.4	65	1.3

Hot Rolled Steel Section Sets

	Label	Shape	Type	Design List	Material	Design ...	A [in2]	Iyy [in4]	Izz [in4]	J [in4]
1	ContCho..	L4x4x6	Beam	Wide Flange	A992	Typical	2.86	4.32	4.32	.141
2	VertGuard	LL3.5x3.5x6x3	Beam	Wide Flange	A992	Typical	5	12.8	5.72	.246
3	CrossBr...	L3.5x3.5x6	Beam	Wide Flange	A992	Typical	2.5	2.86	2.86	.123
4	BottomC...	C6x10.5	Beam	Channel	A992	Typical	3.07	.86	15.1	.128
5	DiagChord	L3.5x3.5x4	None	None	A992	Typical	1.7	2	2	.039
6	End Me...	HSS3.5x3.5x6	None	None	A992	Typical	4.09	6.49	6.49	11.2

Joint Coordinates and Temperatures

	Label	X [ft]	Y [ft]	Z [ft]	Temp [F]	Detach From Diap...
1	N1	0	0	0	0	
2	N2	4	0	0	0	
3	N3	8	0	0	0	
4	N4	12	0	0	0	
5	N5	16	0	0	0	
6	N6	20	0	0	0	
7	N7	24	0	0	0	
8	N8	28	0	0	0	
9	N9	32	0	0	0	
10	N10	36	0	0	0	
11	N11	40	0	0	0	
12	N12	44	0	0	0	
13	N13	48	0	0	0	
14	N14	0	4.5	0	0	
15	N15	4	4.5	0	0	
16	N16	8	4.5	0	0	
17	N17	12	4.5	0	0	
18	N18	16	4.5	0	0	
19	N19	20	4.5	0	0	
20	N20	24	4.5	0	0	
21	N21	28	4.5	0	0	
22	N22	32	4.5	0	0	



Company :
 Designer :
 Job Number :
 Model Name :

July 13, 2017
 4:22 PM
 Checked By: _____

Joint Coordinates and Temperatures (Continued)

	Label	X [ft]	Y [ft]	Z [ft]	Temp [F]	Detach From Diap...
23	N23	36	4.5	0	0	
24	N24	40	4.5	0	0	
25	N25	44	4.5	0	0	
26	N26	48	4.5	0	0	
27	N27	0	0	5	0	
28	N28	4	0	5	0	
29	N29	8	0	5	0	
30	N30	12	0	5	0	
31	N31	16	0	5	0	
32	N32	20	0	5	0	
33	N33	24	0	5	0	
34	N34	28	0	5	0	
35	N35	32	0	5	0	
36	N36	36	0	5	0	
37	N37	40	0	5	0	
38	N38	44	0	5	0	
39	N39	48	0	5	0	
40	N40	0	4.5	5	0	
41	N41	4	4.5	5	0	
42	N42	8	4.5	5	0	
43	N43	12	4.5	5	0	
44	N44	16	4.5	5	0	
45	N45	20	4.5	5	0	
46	N46	24	4.5	5	0	
47	N47	28	4.5	5	0	
48	N48	32	4.5	5	0	
49	N49	36	4.5	5	0	
50	N50	40	4.5	5	0	
51	N51	44	4.5	5	0	
52	N52	48	4.5	5	0	

Joint Boundary Conditions

	Joint Label	X [k/in]	Y [k/in]	Z [k/in]	X Rot.[k-ft/rad]	Y Rot.[k-ft/rad]	Z Rot.[k-ft/rad]
1	N1	Reaction	Reaction	Fixed			
2	N13	Reaction	Reaction	Fixed			
3	N27	Reaction	Reaction	Fixed			
4	N39	Reaction	Reaction	Fixed			

Member Primary Data

	Label	I Joint	J Joint	K Joint	Rotate(...)	Section/Shape	Type	Design List	Material	Design Rules
1	M1	N1	N13			ContChord	Beam	Wide Flange	A992	Typical
2	M2	N14	N26			ContChord	Beam	Wide Flange	A992	Typical
3	M3	N2	N15		90	VertGuard	Beam	Wide Flange	A992	Typical
4	M4	N3	N16		90	VertGuard	Beam	Wide Flange	A992	Typical
5	M5	N4	N17		90	VertGuard	Beam	Wide Flange	A992	Typical
6	M6	N5	N18		90	VertGuard	Beam	Wide Flange	A992	Typical
7	M7	N6	N19		90	VertGuard	Beam	Wide Flange	A992	Typical
8	M8	N7	N20		90	VertGuard	Beam	Wide Flange	A992	Typical
9	M9	N8	N21		90	VertGuard	Beam	Wide Flange	A992	Typical
10	M10	N9	N22		90	VertGuard	Beam	Wide Flange	A992	Typical
11	M11	N10	N23		90	VertGuard	Beam	Wide Flange	A992	Typical
12	M12	N11	N24		90	VertGuard	Beam	Wide Flange	A992	Typical
13	M13	N12	N25		90	VertGuard	Beam	Wide Flange	A992	Typical
14	M14	N13	N26			End Members	None	None	A992	Typical



Company :
 Designer :
 Job Number :
 Model Name :

July 13, 2017
 4:22 PM
 Checked By: _____

Member Primary Data (Continued)

	Label	I Joint	J Joint	K Joint	Rotate(...)	Section/Shape	Type	Design List	Material	Design Rules
15	M15	N26	N12			CrossBrace	Beam	Wide Flange	A992	Typical
16	M16	N25	N11			CrossBrace	Beam	Wide Flange	A992	Typical
17	M17	N24	N10			CrossBrace	Beam	Wide Flange	A992	Typical
18	M18	N23	N9			CrossBrace	Beam	Wide Flange	A992	Typical
19	M19	N22	N8			CrossBrace	Beam	Wide Flange	A992	Typical
20	M20	N21	N7			CrossBrace	Beam	Wide Flange	A992	Typical
21	M21	N7	N19			CrossBrace	Beam	Wide Flange	A992	Typical
22	M22	N18	N6			CrossBrace	Beam	Wide Flange	A992	Typical
23	M23	N5	N17			CrossBrace	Beam	Wide Flange	A992	Typical
24	M24	N4	N16			CrossBrace	Beam	Wide Flange	A992	Typical
25	M25	N3	N15			CrossBrace	Beam	Wide Flange	A992	Typical
26	M26	N2	N14			CrossBrace	Beam	Wide Flange	A992	Typical
27	M27	N1	N14			End Members	None	None	A992	Typical
28	M28	N27	N39			ContChord	Beam	Wide Flange	A992	Typical
29	M29	N40	N52			ContChord	Beam	Wide Flange	A992	Typical
30	M30	N28	N41		270	VertGuard	Beam	Wide Flange	A992	Typical
31	M31	N29	N42		270	VertGuard	Beam	Wide Flange	A992	Typical
32	M32	N30	N43		270	VertGuard	Beam	Wide Flange	A992	Typical
33	M33	N31	N44		270	VertGuard	Beam	Wide Flange	A992	Typical
34	M34	N32	N45		270	VertGuard	Beam	Wide Flange	A992	Typical
35	M35	N33	N46		270	VertGuard	Beam	Wide Flange	A992	Typical
36	M36	N34	N47		270	VertGuard	Beam	Wide Flange	A992	Typical
37	M37	N35	N48		270	VertGuard	Beam	Wide Flange	A992	Typical
38	M38	N36	N49		270	VertGuard	Beam	Wide Flange	A992	Typical
39	M39	N37	N50		270	VertGuard	Beam	Wide Flange	A992	Typical
40	M40	N38	N51		270	VertGuard	Beam	Wide Flange	A992	Typical
41	M41	N39	N52			End Members	None	None	A992	Typical
42	M42	N52	N38			CrossBrace	Beam	Wide Flange	A992	Typical
43	M43	N51	N37			CrossBrace	Beam	Wide Flange	A992	Typical
44	M44	N50	N36			CrossBrace	Beam	Wide Flange	A992	Typical
45	M45	N49	N35			CrossBrace	Beam	Wide Flange	A992	Typical
46	M46	N48	N34			CrossBrace	Beam	Wide Flange	A992	Typical
47	M47	N47	N33			CrossBrace	Beam	Wide Flange	A992	Typical
48	M48	N33	N45			CrossBrace	Beam	Wide Flange	A992	Typical
49	M49	N44	N32			CrossBrace	Beam	Wide Flange	A992	Typical
50	M50	N31	N43			CrossBrace	Beam	Wide Flange	A992	Typical
51	M51	N30	N42			CrossBrace	Beam	Wide Flange	A992	Typical
52	M52	N29	N41			CrossBrace	Beam	Wide Flange	A992	Typical
53	M53	N28	N40			CrossBrace	Beam	Wide Flange	A992	Typical
54	M54	N27	N40			End Members	None	None	A992	Typical
55	M55	N13	N38			DiagChord	None	None	A992	Typical
56	M56	N38	N11			DiagChord	None	None	A992	Typical
57	M57	N11	N36			DiagChord	None	None	A992	Typical
58	M58	N36	N9			DiagChord	None	None	A992	Typical
59	M59	N9	N34			DiagChord	None	None	A992	Typical
60	M60	N34	N7			DiagChord	None	None	A992	Typical
61	M61	N7	N32			DiagChord	None	None	A992	Typical
62	M62	N32	N5			DiagChord	None	None	A992	Typical
63	M63	N5	N30			DiagChord	None	None	A992	Typical
64	M64	N30	N3			DiagChord	None	None	A992	Typical
65	M65	N3	N28			DiagChord	None	None	A992	Typical
66	M66	N28	N1			DiagChord	None	None	A992	Typical
67	M67	N1	N27			End Members	None	None	A992	Typical
68	M68	N2	N28			BottomChord	Beam	Channel	A992	Typical
69	M69	N3	N29			BottomChord	Beam	Channel	A992	Typical
70	M70	N4	N30			BottomChord	Beam	Channel	A992	Typical
71	M71	N5	N31			BottomChord	Beam	Channel	A992	Typical



Company :
 Designer :
 Job Number :
 Model Name :

July 13, 2017
 4:22 PM
 Checked By: _____

Member Primary Data (Continued)

	Label	I Joint	J Joint	K Joint	Rotate(...)	Section/Shape	Type	Design List	Material	Design Rules
72	M72	N6	N32			BottomChord	Beam	Channel	A992	Typical
73	M73	N7	N33			BottomChord	Beam	Channel	A992	Typical
74	M74	N8	N34			BottomChord	Beam	Channel	A992	Typical
75	M75	N9	N35			BottomChord	Beam	Channel	A992	Typical
76	M76	N10	N36			BottomChord	Beam	Channel	A992	Typical
77	M77	N11	N37			BottomChord	Beam	Channel	A992	Typical
78	M78	N12	N38			BottomChord	Beam	Channel	A992	Typical
79	M79	N13	N39			End Members	None	None	A992	Typical

Member Advanced Data

	Label	I Release	J Release	I Offset[in]	J Offset[in]	T/C Only	Physical	Analysis Offset[in]	Inactive	Seismic Desig...
1	M1						Yes			None
2	M2						Yes			None
3	M3		BenPIN				Yes			None
4	M4		BenPIN				Yes			None
5	M5		BenPIN				Yes			None
6	M6		BenPIN				Yes			None
7	M7		BenPIN				Yes			None
8	M8		BenPIN				Yes			None
9	M9		BenPIN				Yes			None
10	M10		BenPIN				Yes			None
11	M11		BenPIN				Yes			None
12	M12		BenPIN				Yes			None
13	M13		BenPIN				Yes			None
14	M14		BenPIN				Yes			None
15	M15	BenPIN	BenPIN				Yes			None
16	M16	BenPIN	BenPIN				Yes			None
17	M17	BenPIN	BenPIN				Yes			None
18	M18	BenPIN	BenPIN				Yes			None
19	M19	BenPIN	BenPIN				Yes			None
20	M20	BenPIN	BenPIN				Yes			None
21	M21	BenPIN	BenPIN				Yes			None
22	M22	BenPIN	BenPIN				Yes			None
23	M23	BenPIN	BenPIN				Yes			None
24	M24	BenPIN	BenPIN				Yes			None
25	M25	BenPIN	BenPIN				Yes			None
26	M26	BenPIN	BenPIN				Yes			None
27	M27		BenPIN				Yes			None
28	M28						Yes			None
29	M29						Yes			None
30	M30		BenPIN				Yes			None
31	M31		BenPIN				Yes			None
32	M32		BenPIN				Yes			None
33	M33		BenPIN				Yes			None
34	M34		BenPIN				Yes			None
35	M35		BenPIN				Yes			None
36	M36		BenPIN				Yes			None
37	M37		BenPIN				Yes			None
38	M38		BenPIN				Yes			None
39	M39		BenPIN				Yes			None
40	M40		BenPIN				Yes			None
41	M41		BenPIN				Yes			None
42	M42	BenPIN	BenPIN				Yes			None
43	M43	BenPIN	BenPIN				Yes			None
44	M44	BenPIN	BenPIN				Yes			None



Company :
 Designer :
 Job Number :
 Model Name :

July 13, 2017
 4:22 PM
 Checked By: _____

Member Advanced Data (Continued)

	Label	I Release	J Release	I Offset[in]	J Offset[in]	T/C Only	Physical	Analysis Offset[in]	Inactive	Seismic Desig...
45	M45	BenPIN	BenPIN				Yes			None
46	M46	BenPIN	BenPIN				Yes			None
47	M47	BenPIN	BenPIN				Yes			None
48	M48	BenPIN	BenPIN				Yes			None
49	M49	BenPIN	BenPIN				Yes			None
50	M50	BenPIN	BenPIN				Yes			None
51	M51	BenPIN	BenPIN				Yes			None
52	M52	BenPIN	BenPIN				Yes			None
53	M53	BenPIN	BenPIN				Yes			None
54	M54		BenPIN				Yes			None
55	M55	BenPIN	BenPIN				Yes			None
56	M56	BenPIN	BenPIN				Yes			None
57	M57	BenPIN	BenPIN				Yes			None
58	M58	BenPIN	BenPIN				Yes			None
59	M59	BenPIN	BenPIN				Yes			None
60	M60	BenPIN	BenPIN				Yes			None
61	M61	BenPIN	BenPIN				Yes			None
62	M62	BenPIN	BenPIN				Yes			None
63	M63	BenPIN	BenPIN				Yes			None
64	M64	BenPIN	BenPIN				Yes			None
65	M65	BenPIN	BenPIN				Yes			None
66	M66	BenPIN	BenPIN				Yes			None
67	M67						Yes			None
68	M68						Yes			None
69	M69						Yes			None
70	M70						Yes			None
71	M71						Yes			None
72	M72						Yes			None
73	M73						Yes			None
74	M74						Yes			None
75	M75						Yes			None
76	M76						Yes			None
77	M77						Yes			None
78	M78						Yes			None
79	M79						Yes			None

Hot Rolled Steel Design Parameters

	Label	Shape	Length[ft]	Lbyy[ft]	Lbzz[ft]	Lcomp top[ft]	Lcomp bot[ft]	L-torqu...	Kyy	Kzz	Cb	Function
1	M1	ContChord	48	4	4	4	4					Lateral
2	M2	ContChord	48	4	4	4	4					Lateral
3	M3	VertGuard	4.5									Lateral
4	M4	VertGuard	4.5									Lateral
5	M5	VertGuard	4.5									Lateral
6	M6	VertGuard	4.5									Lateral
7	M7	VertGuard	4.5									Lateral
8	M8	VertGuard	4.5									Lateral
9	M9	VertGuard	4.5									Lateral
10	M10	VertGuard	4.5									Lateral
11	M11	VertGuard	4.5									Lateral
12	M12	VertGuard	4.5									Lateral
13	M13	VertGuard	4.5									Lateral
14	M14	End Membe...	4.5									Lateral
15	M15	CrossBrace	6.021									Lateral
16	M16	CrossBrace	6.021									Lateral
17	M17	CrossBrace	6.021									Lateral



Company :
 Designer :
 Job Number :
 Model Name :

July 13, 2017
 4:22 PM
 Checked By: _____

Hot Rolled Steel Design Parameters (Continued)

	Label	Shape	Length[ft]	Lby[ft]	Lbzz[ft]	Lcomp top[ft]	Lcomp bot[ft]	L-torqu...	Kyy	Kzz	Cb	Function
18	M18	CrossBrace	6.021									Lateral
19	M19	CrossBrace	6.021									Lateral
20	M20	CrossBrace	6.021									Lateral
21	M21	CrossBrace	6.021									Lateral
22	M22	CrossBrace	6.021									Lateral
23	M23	CrossBrace	6.021									Lateral
24	M24	CrossBrace	6.021									Lateral
25	M25	CrossBrace	6.021									Lateral
26	M26	CrossBrace	6.021									Lateral
27	M27	End Membe...	4.5									Lateral
28	M28	ContChord	48	4	4	4	4					Lateral
29	M29	ContChord	48	4	4	4	4					Lateral
30	M30	VertGuard	4.5									Lateral
31	M31	VertGuard	4.5									Lateral
32	M32	VertGuard	4.5									Lateral
33	M33	VertGuard	4.5									Lateral
34	M34	VertGuard	4.5									Lateral
35	M35	VertGuard	4.5									Lateral
36	M36	VertGuard	4.5									Lateral
37	M37	VertGuard	4.5									Lateral
38	M38	VertGuard	4.5									Lateral
39	M39	VertGuard	4.5									Lateral
40	M40	VertGuard	4.5									Lateral
41	M41	End Membe...	4.5									Lateral
42	M42	CrossBrace	6.021									Lateral
43	M43	CrossBrace	6.021									Lateral
44	M44	CrossBrace	6.021									Lateral
45	M45	CrossBrace	6.021									Lateral
46	M46	CrossBrace	6.021									Lateral
47	M47	CrossBrace	6.021									Lateral
48	M48	CrossBrace	6.021									Lateral
49	M49	CrossBrace	6.021									Lateral
50	M50	CrossBrace	6.021									Lateral
51	M51	CrossBrace	6.021									Lateral
52	M52	CrossBrace	6.021									Lateral
53	M53	CrossBrace	6.021									Lateral
54	M54	End Membe...	4.5									Lateral
55	M55	DiagChord	6.403									Lateral
56	M56	DiagChord	6.403									Lateral
57	M57	DiagChord	6.403									Lateral
58	M58	DiagChord	6.403									Lateral
59	M59	DiagChord	6.403									Lateral
60	M60	DiagChord	6.403									Lateral
61	M61	DiagChord	6.403									Lateral
62	M62	DiagChord	6.403									Lateral
63	M63	DiagChord	6.403									Lateral
64	M64	DiagChord	6.403									Lateral
65	M65	DiagChord	6.403									Lateral
66	M66	DiagChord	6.403									Lateral
67	M67	End Membe...	5									Lateral
68	M68	BottomChord	5									Lateral
69	M69	BottomChord	5									Lateral
70	M70	BottomChord	5									Lateral
71	M71	BottomChord	5									Lateral
72	M72	BottomChord	5									Lateral
73	M73	BottomChord	5									Lateral
74	M74	BottomChord	5									Lateral



Company :
 Designer :
 Job Number :
 Model Name :

July 13, 2017
 4:22 PM
 Checked By: _____

Hot Rolled Steel Design Parameters (Continued)

	Label	Shape	Length[ft]	Lbyy[ft]	Lbzz[ft]	Lcomp top[ft]	Lcomp bot[ft]	L-torqu...	Kyy	Kzz	Cb	Function
75	M75	BottomChord	5									Lateral
76	M76	BottomChord	5									Lateral
77	M77	BottomChord	5									Lateral
78	M78	BottomChord	5									Lateral
79	M79	End Membe...	5									Lateral

Member Area Loads (BLC 1 : Dead)

	Joint A	Joint B	Joint C	Joint D	Direction	Distribution	Magnitude[ksf]
1	N27	N1	N13	N39	Y	Perp to A-B	-02

Member Area Loads (BLC 2 : Snow)

	Joint A	Joint B	Joint C	Joint D	Direction	Distribution	Magnitude[ksf]
1	N27	N1	N13	N39	Y	Perp to A-B	-0192

Load Combination Design

	Description	ASIF	CD	ABIF	Service	Hot Rolled	Cold For...	Wood	Concrete	Masonry	Footings	Aluminum	Connecti...
1	IBC 16-1				Yes	Yes			Yes	Yes	Yes		Yes
2	IBC 16-3 (c)				Yes	Yes			Yes	Yes	Yes		Yes

Envelope Joint Reactions

	Joint		X [k]	LC	Y [k]	LC	Z [k]	LC	MX [k-ft]	LC	MY [k-ft]	LC	MZ [k-ft]	LC
1	N1	max	33.672	2	21.72	2	NC	NC	0	1	0	1	0	1
2		min	5.85	1	3.847	1	NC	NC	0	1	0	1	0	1
3	N13	max	-5.85	1	21.72	2	NC	NC	0	1	0	1	0	1
4		min	-33.672	2	3.847	1	NC	NC	0	1	0	1	0	1
5	N27	max	34.009	2	21.739	2	NC	NC	0	1	0	1	0	1
6		min	5.869	1	3.847	1	NC	NC	0	1	0	1	0	1
7	N39	max	-5.869	1	21.739	2	NC	NC	0	1	0	1	0	1
8		min	-34.009	2	3.847	1	NC	NC	0	1	0	1	0	1
9	Totals:	max	0	2	86.917	2	0	1						
10		min	0	1	15.387	1	0	1						

Envelope Joint Displacements

	Joint		X [in]	LC	Y [in]	LC	Z [in]	LC	X Rotati...	LC	Y Rotation...	LC	Z Rotation [rad]	LC
1	N1	max	0	1	0	1	0	1	1.36e-03	2	-4.248e-05	1	-7.628e-04	1
2		min	0	2	0	2	0	1	1.807e-04	1	-2.729e-04	2	-4.319e-03	2
3	N2	max	-004	1	-042	1	.018	2	1.568e-03	2	-9.495e-05	1	-7.541e-04	1
4		min	-024	2	-242	2	.003	1	1.663e-04	1	-5.466e-04	2	-4.349e-03	2
5	N3	max	-006	1	-082	1	.009	2	1.413e-03	2	-2.e-05	1	-6.954e-04	1
6		min	-036	2	-474	2	.002	1	1.503e-04	1	-1.151e-04	2	-4.005e-03	2
7	N4	max	-006	1	-117	1	.01	2	1.637e-03	2	-6.448e-05	1	-5.811e-04	1
8		min	-037	2	-674	2	.002	1	1.68e-04	1	-3.722e-04	2	-3.348e-03	2
9	N5	max	-005	1	-145	1	.015	2	1.417e-03	2	-1.265e-05	1	-4.175e-04	1
10		min	-03	2	-833	2	.003	1	1.466e-04	1	-7.282e-05	2	-2.405e-03	2
11	N6	max	-003	1	-162	1	.006	2	1.662e-03	2	-3.387e-05	1	-2.291e-04	1
12		min	-016	2	-934	2	0	1	1.712e-04	1	-1.945e-04	2	-1.319e-03	2
13	N7	max	0	1	-17	1	.018	2	1.399e-03	2	0	2	0	1
14		min	0	2	-978	2	.003	1	1.437e-04	1	0	1	0	2
15	N8	max	.016	2	-162	1	.006	2	1.662e-03	2	1.945e-04	2	1.319e-03	2
16		min	.003	1	-934	2	0	1	1.712e-04	1	3.387e-05	1	2.291e-04	1



Company :
 Designer :
 Job Number :
 Model Name :

July 13, 2017
 4:22 PM
 Checked By: _____

Envelope Joint Displacements (Continued)

Joint	X [in]	LC	Y [in]	LC	Z [in]	LC	X Rotati...	LC	Y Rotation...	LC	Z Rotation [rad]	LC		
17	N9	max	.03	2	-.145	1	.015	2	1.417e-03	2	7.282e-05	2	2.405e-03	2
18		min	.005	1	-.833	2	.003	1	1.466e-04	1	1.265e-05	1	4.175e-04	1
19	N10	max	.037	2	-.117	1	.01	2	1.637e-03	2	3.722e-04	2	3.348e-03	2
20		min	.006	1	-.674	2	.002	1	1.68e-04	1	6.448e-05	1	5.811e-04	1
21	N11	max	.036	2	-.082	1	.009	2	1.413e-03	2	1.151e-04	2	4.005e-03	2
22		min	.006	1	-.474	2	.002	1	1.503e-04	1	2.e-05	1	6.954e-04	1
23	N12	max	.024	2	-.042	1	.018	2	1.568e-03	2	5.466e-04	2	4.349e-03	2
24		min	.004	1	-.242	2	.003	1	1.663e-04	1	9.495e-05	1	7.541e-04	1
25	N13	max	0	2	0	1	0	1	1.36e-03	2	2.729e-04	2	4.319e-03	2
26		min	0	1	0	2	0	1	1.807e-04	1	4.248e-05	1	7.628e-04	1
27	N14	max	.187	2	-.002	1	.08	2	1.716e-03	2	-1.679e-05	1	-9.082e-04	1
28		min	.033	1	-.011	2	.01	1	2.159e-04	1	-2.955e-04	2	-5.026e-03	2
29	N15	max	.175	2	-.044	1	.092	2	1.681e-03	2	-7.472e-06	1	-8.482e-04	1
30		min	.03	1	-.249	2	.011	1	2.061e-04	1	-1.407e-04	2	-4.933e-03	2
31	N16	max	.152	2	-.083	1	.093	2	1.723e-03	2	1.358e-05	1	-7.888e-04	1
32		min	.026	1	-.48	2	.011	1	2.069e-04	1	-2.269e-06	2	-4.529e-03	2
33	N17	max	.12	2	-.118	1	.095	2	1.68e-03	2	1.671e-06	1	-6.496e-04	1
34		min	.021	1	-.678	2	.011	1	1.952e-04	1	-9.535e-06	2	-3.745e-03	2
35	N18	max	.083	2	-.145	1	.094	2	1.687e-03	2	-8.339e-07	1	-4.675e-04	1
36		min	.014	1	-.835	2	.01	1	1.919e-04	1	-4.26e-06	2	-2.69e-03	2
37	N19	max	.042	2	-.163	1	.094	2	1.645e-03	2	7.308e-05	2	-2.702e-04	1
38		min	.007	1	-.935	2	.01	1	1.843e-04	1	9.794e-06	1	-1.555e-03	2
39	N20	max	0	1	-.17	1	.089	2	1.645e-03	2	0	2	0	1
40		min	0	2	-.978	2	.01	1	1.843e-04	1	0	1	0	2
41	N21	max	-.007	1	-.163	1	.094	2	1.645e-03	2	-9.794e-06	1	1.555e-03	2
42		min	-.042	2	-.935	2	.01	1	1.843e-04	1	-7.308e-05	2	2.702e-04	1
43	N22	max	-.014	1	-.145	1	.094	2	1.687e-03	2	4.26e-06	2	2.69e-03	2
44		min	-.083	2	-.835	2	.01	1	1.919e-04	1	8.339e-07	1	4.675e-04	1
45	N23	max	-.021	1	-.118	1	.095	2	1.68e-03	2	9.535e-06	2	3.745e-03	2
46		min	-.12	2	-.678	2	.011	1	1.952e-04	1	-1.671e-06	1	6.496e-04	1
47	N24	max	-.026	1	-.083	1	.093	2	1.723e-03	2	2.269e-06	2	4.529e-03	2
48		min	-.152	2	-.48	2	.011	1	2.069e-04	1	-1.358e-05	1	7.888e-04	1
49	N25	max	-.03	1	-.044	1	.092	2	1.681e-03	2	1.407e-04	2	4.933e-03	2
50		min	-.175	2	-.249	2	.011	1	2.061e-04	1	7.472e-06	1	8.482e-04	1
51	N26	max	-.033	1	-.002	1	.08	2	1.716e-03	2	2.955e-04	2	5.026e-03	2
52		min	-.187	2	-.011	2	.01	1	2.159e-04	1	1.679e-05	1	9.082e-04	1
53	N27	max	0	1	0	1	0	1	-1.814e...	1	-4.899e-05	1	-7.681e-04	1
54		min	0	2	0	2	0	1	-1.413e...	2	-2.909e-04	2	-4.38e-03	2
55	N28	max	-.004	1	-.043	1	.018	2	-1.438e...	1	-9.383e-05	1	-7.562e-04	1
56		min	-.024	2	-.246	2	.003	1	-1.291e...	2	-5.438e-04	2	-4.374e-03	2
57	N29	max	-.006	1	-.083	1	.01	2	-1.513e...	1	-1.986e-05	1	-6.97e-04	1
58		min	-.036	2	-.477	2	.002	1	-1.45e-03	2	-1.135e-04	2	-4.027e-03	2
59	N30	max	-.006	1	-.118	1	.01	2	-1.322e...	1	-6.404e-05	1	-5.819e-04	1
60		min	-.037	2	-.681	2	.002	1	-1.242e...	2	-3.702e-04	2	-3.362e-03	2
61	N31	max	-.005	1	-.145	1	.015	2	-1.529e...	1	-1.241e-05	1	-4.18e-04	1
62		min	-.029	2	-.837	2	.003	1	-1.453e...	2	-7.168e-05	2	-2.414e-03	2
63	N32	max	-.003	1	-.163	1	.005	2	-1.299e...	1	-3.368e-05	1	-2.293e-04	1
64		min	-.017	2	-.942	2	0	1	-1.217e...	2	-1.939e-04	2	-1.323e-03	2
65	N33	max	0	1	-.17	1	.018	2	-1.565e...	1	0	2	0	1
66		min	0	2	-.982	2	.003	1	-1.467e...	2	0	1	0	2
67	N34	max	.017	2	-.163	1	.005	2	-1.299e...	1	1.939e-04	2	1.323e-03	2
68		min	.003	1	-.942	2	0	1	-1.217e...	2	3.368e-05	1	2.293e-04	1
69	N35	max	.029	2	-.145	1	.015	2	-1.529e...	1	7.168e-05	2	2.414e-03	2
70		min	.005	1	-.837	2	.003	1	-1.453e...	2	1.241e-05	1	4.18e-04	1
71	N36	max	.037	2	-.118	1	.01	2	-1.322e...	1	3.702e-04	2	3.362e-03	2
72		min	.006	1	-.681	2	.002	1	-1.242e...	2	6.404e-05	1	5.819e-04	1
73	N37	max	.036	2	-.083	1	.01	2	-1.513e...	1	1.135e-04	2	4.027e-03	2

1" MAX DEFLECTION



Company :
 Designer :
 Job Number :
 Model Name :

July 13, 2017
 4:22 PM
 Checked By: _____

Envelope Joint Displacements (Continued)

	Joint		X [in]	LC	Y [in]	LC	Z [in]	LC	X Rotati...	LC	Y Rotation...	LC	Z Rotation [rad]	LC
74		min	.006	1	-.477	2	.002	1	-1.45e-03	2	1.986e-05	1	6.97e-04	1
75	N38	max	.024	2	-.043	1	.018	2	-1.438e-...	1	5.438e-04	2	4.374e-03	2
76		min	.004	1	-.246	2	.003	1	-1.291e-...	2	9.383e-05	1	7.562e-04	1
77	N39	max	0	2	0	1	0	1	-1.814e-...	1	2.909e-04	2	4.38e-03	2
78		min	0	1	0	2	0	1	-1.413e-...	2	4.899e-05	1	7.681e-04	1
79	N40	max	.189	2	-.002	1	-.009	1	-1.111e-...	1	-4.103e-05	1	-9.243e-04	1
80		min	.033	1	-.012	2	-.071	2	-1.115e-...	2	-2.488e-04	2	-5.116e-03	2
81	N41	max	.176	2	-.044	1	-.006	1	-1.179e-...	1	-4.086e-05	1	-8.472e-04	1
82		min	.03	1	-.254	2	-.061	2	-1.155e-...	2	-1.048e-04	2	-4.948e-03	2
83	N42	max	.153	2	-.084	1	-.006	1	-1.102e-...	1	3.218e-05	2	-7.914e-04	1
84		min	.026	1	-.483	2	-.061	2	-1.121e-...	2	1.336e-06	1	-4.555e-03	2
85	N43	max	.121	2	-.119	1	-.006	1	-1.156e-...	1	1.983e-07	1	-6.501e-04	1
86		min	.021	1	-.685	2	-.061	2	-1.173e-...	2	-2.336e-07	2	-3.757e-03	2
87	N44	max	.083	2	-.146	1	-.006	1	-1.152e-...	1	1.607e-06	1	-4.684e-04	1
88		min	.014	1	-.84	2	-.061	2	-1.173e-...	2	-1.316e-06	2	-2.702e-03	2
89	N45	max	.042	2	-.163	1	-.006	1	-1.211e-...	1	6.617e-05	2	-2.697e-04	1
90		min	.007	1	-.943	2	-.062	2	-1.218e-...	2	1.101e-05	1	-1.553e-03	2
91	N46	max	0	1	-.17	1	-.006	1	-1.211e-...	1	0	2	0	1
92		min	0	2	-.983	2	-.065	2	-1.218e-...	2	0	1	0	2
93	N47	max	-.007	1	-.163	1	-.006	1	-1.211e-...	1	-1.101e-05	1	1.553e-03	2
94		min	-.042	2	-.943	2	-.062	2	-1.218e-...	2	-6.617e-05	2	2.697e-04	1
95	N48	max	-.014	1	-.146	1	-.006	1	-1.152e-...	1	1.316e-06	2	2.702e-03	2
96		min	-.083	2	-.84	2	-.061	2	-1.173e-...	2	-1.607e-06	1	4.684e-04	1
97	N49	max	-.021	1	-.119	1	-.006	1	-1.156e-...	1	2.336e-07	2	3.757e-03	2
98		min	-.121	2	-.685	2	-.061	2	-1.173e-...	2	-1.983e-07	1	6.501e-04	1
99	N50	max	-.026	1	-.084	1	-.006	1	-1.102e-...	1	-1.336e-06	1	4.555e-03	2
100		min	-.153	2	-.483	2	-.061	2	-1.121e-...	2	-3.218e-05	2	7.914e-04	1
101	N51	max	-.03	1	-.044	1	-.006	1	-1.179e-...	1	1.048e-04	2	4.948e-03	2
102		min	-.176	2	-.254	2	-.061	2	-1.155e-...	2	4.086e-05	1	8.472e-04	1
103	N52	max	-.033	1	-.002	1	-.009	1	-1.111e-...	1	2.488e-04	2	5.116e-03	2
104		min	-.189	2	-.012	2	-.071	2	-1.115e-...	2	4.103e-05	1	9.243e-04	1

Member AISC 14th(360-10): LRFD Steel Code Checks

	LC	Member	Shape	UC Max	Loc[ft]	Shear..	Loc[ft]...	phi*P...	phi*P...	phi*M...	phi*M...	Cb	Eqn	
1	1	M1	L4x4x6	.080	4	.002	48	y	97.503	128.7	6.109	12.844	1	H2-1
2	1	M2	L4x4x6	.111	22.5	.001	28	y	97.503	128.7	6.109	12.844	1	H2-1
3	1	M3	LL3.5x3...	.017	0	.001	0	z	186.7...	225	20.827	8.58	1.6...	H1-1b
4	1	M4	LL3.5x3...	.013	0	.000	0	z	186.7...	225	20.827	13.728	1.6...	H1-1b
5	1	M5	LL3.5x3...	.010	0	.000	0	z	186.7...	225	20.827	8.58	1.6...	H1-1b
6	1	M6	LL3.5x3...	.007	0	.000	0	z	186.7...	225	20.827	8.58	1.6...	H1-1b
7	1	M7	LL3.5x3...	.004	0	.000	0	z	186.7...	225	20.827	13.728	1.6...	H1-1b
8	1	M8	LL3.5x3...	.002	0	.000	0	y	186.7...	225	20.827	8.58	1	H1-1b
9	1	M9	LL3.5x3...	.004	0	.000	0	z	186.7...	225	20.827	13.728	1.6...	H1-1b
10	1	M10	LL3.5x3...	.007	0	.000	0	z	186.7...	225	20.827	8.58	1.6...	H1-1b
11	1	M11	LL3.5x3...	.010	0	.000	0	z	186.7...	225	20.827	8.58	1.6...	H1-1b
12	1	M12	LL3.5x3...	.013	0	.000	0	z	186.7...	225	20.827	13.728	1.6...	H1-1b
13	1	M13	LL3.5x3...	.017	0	.001	0	z	186.7...	225	20.827	8.58	1.6...	H1-1b
14	1	M14	HSS3.5...	.022	0	.001	0	y	160.91	184.05	17.588	17.588	1.6...	H1-...
15	1	M15	L3.5x3...	.048	2.948	.001	6.021	y	49.639	112.5	4.639	9.175	1.1...	H2-1
16	1	M16	L3.5x3...	.042	2.948	.001	0	y	49.639	112.5	4.639	9.175	1.1...	H2-1
17	1	M17	L3.5x3...	.033	2.948	.001	6.021	y	49.639	112.5	4.639	9.175	1.1...	H2-1
18	1	M18	L3.5x3...	.027	2.948	.001	6.021	y	49.639	112.5	4.639	9.175	1.1...	H2-1
19	1	M19	L3.5x3...	.019	2.948	.001	6.021	y	49.639	112.5	4.639	9.175	1.1...	H2-1
20	1	M20	L3.5x3...	.012	2.948	.001	0	y	49.639	112.5	4.639	9.175	1.1...	H2-1
21	1	M21	L3.5x3...	.012	3.073	.001	6.021	y	49.639	112.5	4.639	9.175	1.1...	H2-1



Company :
 Designer :
 Job Number :
 Model Name :

July 13, 2017
 4:22 PM
 Checked By: _____

Member AISC 14th(360-10): LRFD Steel Code Checks (Continued)

LC	Member	Shape	UC Max	Locfft	Shear	Locfft	phi*P	phi*P	phi*M	phi*M	Cb	Eqn	
22	1	M22	L3.5x3...	.019	2.948	.001	6.021	y	49.639	112.5	4.639	9.175	1.1..H2-1
23	1	M23	L3.5x3...	.027	3.073	.001	6.021	y	49.639	112.5	4.639	9.175	1.1..H2-1
24	1	M24	L3.5x3...	.033	3.073	.001	6.021	y	49.639	112.5	4.639	9.175	1.1..H2-1
25	1	M25	L3.5x3...	.042	3.073	.001	0	y	49.639	112.5	4.639	9.175	1.1..H2-1
26	1	M26	L3.5x3...	.048	3.073	.001	6.021	y	49.639	112.5	4.639	9.175	1.1..H2-1
27	1	M27	HSS3.5...	.022	0	.001	0	y	160.91	184.05	17.588	17.588	1.6..H1-...
28	1	M28	L4x4x6	.080	44	.002	48	y	97.503	128.7	6.109	12.844	1 H2-1
29	1	M29	L4x4x6	.111	25.5	.001	28	y	97.503	128.7	6.109	12.844	1 H2-1
30	1	M30	LL3.5x3...	.017	0	.001	0	z	186.7..	225	20.827	13.728	1.6..H1-1b
31	1	M31	LL3.5x3...	.014	0	.000	0	z	186.7..	225	20.827	8.58	1.6..H1-1b
32	1	M32	LL3.5x3...	.010	0	.000	0	z	186.7..	225	20.827	13.728	1.6..H1-1b
33	1	M33	LL3.5x3...	.007	0	.000	0	z	186.7..	225	20.827	13.728	1.6..H1-1b
34	1	M34	LL3.5x3...	.004	0	.000	0	z	186.7..	225	20.827	8.58	1.6..H1-1b
35	1	M35	LL3.5x3...	.001	0	.000	0	y	186.7..	225	20.827	13.728	1 H1-1b
36	1	M36	LL3.5x3...	.004	0	.000	0	z	186.7..	225	20.827	8.58	1.6..H1-1b
37	1	M37	LL3.5x3...	.007	0	.000	0	z	186.7..	225	20.827	13.728	1.6..H1-1b
38	1	M38	LL3.5x3...	.010	0	.000	0	z	186.7..	225	20.827	13.728	1.6..H1-1b
39	1	M39	LL3.5x3...	.014	0	.000	0	z	186.7..	225	20.827	8.58	1.6..H1-1b
40	1	M40	LL3.5x3...	.017	0	.001	0	z	186.7..	225	20.827	13.728	1.6..H1-1b
41	1	M41	HSS3.5...	.022	0	.001	0	y	160.91	184.05	17.588	17.588	1.6..H1-...
42	1	M42	L3.5x3...	.050	2.948	.001	6.021	y	49.639	112.5	4.639	9.175	1.1..H2-1
43	1	M43	L3.5x3...	.041	2.948	.001	6.021	y	49.639	112.5	4.639	9.175	1.1..H2-1
44	1	M44	L3.5x3...	.035	2.948	.001	0	y	49.639	112.5	4.639	9.175	1.1..H2-1
45	1	M45	L3.5x3...	.026	2.948	.001	0	y	49.639	112.5	4.639	9.175	1.1..H2-1
46	1	M46	L3.5x3...	.020	2.948	.001	6.021	y	49.639	112.5	4.639	9.175	1.1..H2-1
47	1	M47	L3.5x3...	.011	2.948	.001	0	y	49.639	112.5	4.639	9.175	1.1..H2-1
48	1	M48	L3.5x3...	.011	3.073	.001	0	y	49.639	112.5	4.639	9.175	1.1..H2-1
49	1	M49	L3.5x3...	.020	2.948	.001	6.021	y	49.639	112.5	4.639	9.175	1.1..H2-1
50	1	M50	L3.5x3...	.026	3.073	.001	6.021	y	49.639	112.5	4.639	9.175	1.1..H2-1
51	1	M51	L3.5x3...	.035	3.073	.001	0	y	49.639	112.5	4.639	9.175	1.1..H2-1
52	1	M52	L3.5x3...	.041	3.073	.001	0	y	49.639	112.5	4.639	9.175	1.1..H2-1
53	1	M53	L3.5x3...	.050	3.073	.001	6.021	y	49.639	112.5	4.639	9.175	1.1..H2-1
54	1	M54	HSS3.5...	.022	0	.001	0	y	160.91	184.05	17.588	17.588	1.6..H1-...
55	1	M55	L3.5x3...	.093	3.202	.007	0	y	30.289	76.5	3.313	5.593	1.1..H2-1
56	1	M56	L3.5x3...	.091	3.202	.007	0	y	30.289	76.5	3.313	5.593	1.1..H2-1
57	1	M57	L3.5x3...	.091	3.202	.007	0	y	30.289	76.5	3.313	5.593	1.1..H2-1
58	1	M58	L3.5x3...	.091	3.202	.007	0	y	30.289	76.5	3.313	5.593	1.1..H2-1
59	1	M59	L3.5x3...	.091	3.202	.007	0	y	30.289	76.5	3.313	5.593	1.1..H2-1
60	1	M60	L3.5x3...	.091	3.202	.007	6.403	y	30.289	76.5	3.313	5.593	1.1..H2-1
61	1	M61	L3.5x3...	.091	3.202	.007	6.403	y	30.289	76.5	3.313	5.593	1.1..H2-1
62	1	M62	L3.5x3...	.091	3.202	.007	0	y	30.289	76.5	3.313	5.593	1.1..H2-1
63	1	M63	L3.5x3...	.091	3.202	.007	6.403	y	30.289	76.5	3.313	5.593	1.1..H2-1
64	1	M64	L3.5x3...	.091	3.202	.007	6.403	y	30.289	76.5	3.313	5.593	1.1..H2-1
65	1	M65	L3.5x3...	.091	3.202	.007	6.403	y	30.289	76.5	3.313	5.593	1.1..H2-1
66	1	M66	L3.5x3...	.093	3.202	.007	0	y	30.289	76.5	3.313	5.593	1.1..H2-1
67	1	M67	HSS3.5...	.009	3.177	.003	5	y	155.9..	184.05	17.588	17.588	1.1..H1-1b
68	1	M68	C6x10.5	.012	1.771	.005	0	y	53.985	138.15	3.373	21.675	1.1..H1-1b
69	1	M69	C6x10.5	.010	2.865	.004	5	y	53.985	138.15	3.373	21.756	1.1..H1-1b
70	1	M70	C6x10.5	.011	1.875	.004	0	y	53.985	138.15	3.373	21.835	1.1..H1-1b
71	1	M71	C6x10.5	.010	2.917	.004	5	y	53.985	138.15	3.373	21.875	1.1..H1-1b
72	1	M72	C6x10.5	.011	1.979	.004	0	y	53.985	138.15	3.373	21.874	1.1..H1-1b
73	1	M73	C6x10.5	.011	2.865	.004	5	y	53.985	138.15	3.373	21.98	1.1..H1-1b
74	1	M74	C6x10.5	.011	1.979	.004	0	y	53.985	138.15	3.373	21.874	1.1..H1-1b
75	1	M75	C6x10.5	.010	2.917	.004	5	y	53.985	138.15	3.373	21.875	1.1..H1-1b
76	1	M76	C6x10.5	.011	1.875	.004	0	y	53.985	138.15	3.373	21.835	1.1..H1-1b
77	1	M77	C6x10.5	.010	2.865	.004	5	y	53.985	138.15	3.373	21.756	1.1..H1-1b
78	1	M78	C6x10.5	.012	1.771	.005	0	y	53.985	138.15	3.373	21.675	1.1..H1-1b



Company :
 Designer :
 Job Number :
 Model Name :

July 13, 2017
 4:22 PM
 Checked By: _____

Member AISC 14th(360-10): LRFD Steel Code Checks (Continued)

LC	Member	Shape	UC Max	Loc(ft)	Shear	Loc(ft)	phi*P	phi*P	phi*M	phi*M	Cb	Eqn	
79	1	M79	HSS3.5...	.009	3.177	.003	5	y	155.9	184.05	17.588	17.588	1.1..H1-1b
80	2	M1	L4x4x6	.452	44	.009	48	y	97.503	128.7	6.109	12.844	1 H2-1
81	2	M2	L4x4x6	.643	24	.002	28	y	97.503	128.7	6.109	12.844	1 H2-1
82	2	M3	LL3.5x3...	.102	0	.004	0	z	186.7	.225	20.827	8.58	1.6..H1-1b
83	2	M4	LL3.5x3...	.074	0	.003	0	z	186.7	.225	20.827	13.728	1.6..H1-1b
84	2	M5	LL3.5x3...	.059	0	.003	0	z	186.7	.225	20.827	8.58	1.6..H1-1b
85	2	M6	LL3.5x3...	.037	0	.002	0	z	186.7	.225	20.827	13.728	1.6..H1-1b
86	2	M7	LL3.5x3...	.023	0	.002	0	z	186.7	.225	20.827	8.58	1.6..H1-1b
87	2	M8	LL3.5x3...	.006	0	.000	0	y	186.7	.225	20.827	8.58	1 H1-1b
88	2	M9	LL3.5x3...	.023	0	.002	0	z	186.7	.225	20.827	8.58	1.6..H1-1b
89	2	M10	LL3.5x3...	.037	0	.002	0	z	186.7	.225	20.827	13.728	1.6..H1-1b
90	2	M11	LL3.5x3...	.059	0	.003	0	z	186.7	.225	20.827	8.58	1.6..H1-1b
91	2	M12	LL3.5x3...	.074	0	.003	0	z	186.7	.225	20.827	13.728	1.6..H1-1b
92	2	M13	LL3.5x3...	.102	0	.004	0	z	186.7	.225	20.827	8.58	1.6..H1-1b
93	2	M14	HSS3.5...	.120	0	.004	0	y	160.91	184.05	17.588	17.588	1.6..H1-...
94	2	M15	L3.5x3....	.235	2.948	.001	0	y	49.639	112.5	4.639	9.175	1.1..H2-1
95	2	M16	L3.5x3....	.207	2.948	.001	0	y	49.639	112.5	4.639	9.175	1.1..H2-1
96	2	M17	L3.5x3....	.151	2.948	.001	6.021	y	49.639	112.5	4.639	9.175	1.1..H2-1
97	2	M18	L3.5x3....	.120	2.948	.001	0	y	49.639	112.5	4.639	9.175	1.1..H2-1
98	2	M19	L3.5x3....	.066	2.948	.001	0	y	49.639	112.5	4.639	9.175	1.1..H2-1
99	2	M20	L3.5x3....	.033	2.948	.001	0	y	49.639	112.5	4.639	9.175	1.1..H2-1
100	2	M21	L3.5x3....	.033	3.073	.001	0	y	49.639	112.5	4.639	9.175	1.1..H2-1
101	2	M22	L3.5x3....	.066	2.948	.001	6.021	y	49.639	112.5	4.639	9.175	1.1..H2-1
102	2	M23	L3.5x3....	.120	3.073	.001	0	y	49.639	112.5	4.639	9.175	1.1..H2-1
103	2	M24	L3.5x3....	.151	3.073	.001	6.021	y	49.639	112.5	4.639	9.175	1.1..H2-1
104	2	M25	L3.5x3....	.207	3.073	.001	6.021	y	49.639	112.5	4.639	9.175	1.1..H2-1
105	2	M26	L3.5x3....	.235	3.073	.001	0	y	49.639	112.5	4.639	9.175	1.1..H2-1
106	2	M27	HSS3.5...	.120	0	.004	0	y	160.91	184.05	17.588	17.588	1.6..H1-...
107	2	M28	L4x4x6	.458	44	.010	48	y	97.503	128.7	6.109	12.844	1 H2-1
108	2	M29	L4x4x6	.636	24.5	.001	8	y	97.503	128.7	6.109	12.844	1 H2-1
109	2	M30	LL3.5x3...	.093	0	.004	0	z	186.7	.225	20.827	13.728	1.6..H1-1b
110	2	M31	LL3.5x3...	.082	0	.003	0	z	186.7	.225	20.827	8.58	1.6..H1-1b
111	2	M32	LL3.5x3...	.056	0	.003	0	z	186.7	.225	20.827	13.728	1.6..H1-1b
112	2	M33	LL3.5x3...	.041	0	.002	0	z	186.7	.225	20.827	8.58	1.6..H1-1b
113	2	M34	LL3.5x3...	.021	0	.002	0	z	186.7	.225	20.827	13.728	1.6..H1-1b
114	2	M35	LL3.5x3...	.003	0	.000	0	y	186.7	.225	20.827	13.728	1 H1-1b
115	2	M36	LL3.5x3...	.021	0	.002	0	z	186.7	.225	20.827	13.728	1.6..H1-1b
116	2	M37	LL3.5x3...	.041	0	.002	0	z	186.7	.225	20.827	8.58	1.6..H1-1b
117	2	M38	LL3.5x3...	.056	0	.003	0	z	186.7	.225	20.827	13.728	1.6..H1-1b
118	2	M39	LL3.5x3...	.082	0	.003	0	z	186.7	.225	20.827	8.58	1.6..H1-1b
119	2	M40	LL3.5x3...	.093	0	.004	0	z	186.7	.225	20.827	13.728	1.6..H1-1b
120	2	M41	HSS3.5...	.126	0	.004	0	y	160.91	184.05	17.588	17.588	1.6..H1-...
121	2	M42	L3.5x3....	.247	2.948	.001	0	y	49.639	112.5	4.639	9.175	1.1..H2-1
122	2	M43	L3.5x3....	.194	2.948	.001	0	y	49.639	112.5	4.639	9.175	1.1..H2-1
123	2	M44	L3.5x3....	.163	2.948	.001	0	y	49.639	112.5	4.639	9.175	1.1..H2-1
124	2	M45	L3.5x3....	.107	2.948	.001	0	y	49.639	112.5	4.639	9.175	1.1..H2-1
125	2	M46	L3.5x3....	.078	2.948	.001	6.021	y	49.639	112.5	4.639	9.175	1.1..H2-1
126	2	M47	L3.5x3....	.020	2.948	.001	0	y	49.639	112.5	4.639	9.175	1.1..H2-1
127	2	M48	L3.5x3....	.020	3.073	.001	0	y	49.639	112.5	4.639	9.175	1.1..H2-1
128	2	M49	L3.5x3....	.078	2.948	.001	6.021	y	49.639	112.5	4.639	9.175	1.1..H2-1
129	2	M50	L3.5x3....	.107	3.073	.001	6.021	y	49.639	112.5	4.639	9.175	1.1..H2-1
130	2	M51	L3.5x3....	.163	3.073	.001	6.021	y	49.639	112.5	4.639	9.175	1.1..H2-1
131	2	M52	L3.5x3....	.194	3.073	.001	0	y	49.639	112.5	4.639	9.175	1.1..H2-1
132	2	M53	L3.5x3....	.247	3.073	.001	6.021	y	49.639	112.5	4.639	9.175	1.1..H2-1
133	2	M54	HSS3.5...	.126	0	.004	0	y	160.91	184.05	17.588	17.588	1.6..H1-...
134	2	M55	L3.5x3....	.930	3.202	.073	0	y	30.289	76.5	3.313	5.593	1.1..H2-1
135	2	M56	L3.5x3....	.919	3.202	.073	0	y	30.289	76.5	3.313	5.593	1.1..H2-1



Company :
 Designer :
 Job Number :
 Model Name :

July 13, 2017
 4:22 PM
 Checked By: _____

Member AISC 14th(360-10): LRFD Steel Code Checks (Continued)

LC	Member	Shape	UC Max	Locfft]	Shear..	Locfft]	...	phi*P...	phi*P...	phi*M...	phi*M...	Cb	Ean
136	2	M57	L3.5x3...	.917	3.202	.072	6.403	y	30.289	76.5	3.313	5.593	1.1... H2-1
137	2	M58	L3.5x3...	.915	3.202	.072	0	y	30.289	76.5	3.313	5.593	1.1... H2-1
138	2	M59	L3.5x3...	.916	3.202	.072	6.403	y	30.289	76.5	3.313	5.593	1.1... H2-1
139	2	M60	L3.5x3...	.918	3.202	.072	0	y	30.289	76.5	3.313	5.593	1.1... H2-1
140	2	M61	L3.5x3...	.918	3.202	.072	0	y	30.289	76.5	3.313	5.593	1.1... H2-1
141	2	M62	L3.5x3...	.916	3.202	.072	0	y	30.289	76.5	3.313	5.593	1.1... H2-1
142	2	M63	L3.5x3...	.915	3.202	.072	6.403	y	30.289	76.5	3.313	5.593	1.1... H2-1
143	2	M64	L3.5x3...	.917	3.202	.072	0	y	30.289	76.5	3.313	5.593	1.1... H2-1
144	2	M65	L3.5x3...	.919	3.202	.073	6.403	y	30.289	76.5	3.313	5.593	1.1... H2-1
145	2	M66	L3.5x3...	.930	3.202	.073	6.403	y	30.289	76.5	3.313	5.593	1.1... H2-1
146	2	M67	HSS3.5...	.068	3.177	.026	5	y	155.9...	184.05	17.588	17.588	1.1... H1-1b
147	2	M68	C6x10.5	.103	1.875	.045	0	y	53.985	138.15	3.373	21.894	1.1... H1-1b
148	2	M69	C6x10.5	.099	2.917	.045	5	y	53.985	138.15	3.373	21.913	1.1... H1-1b
149	2	M70	C6x10.5	.102	1.927	.044	0	y	53.985	138.15	3.373	21.955	1.1... H1-1b
150	2	M71	C6x10.5	.099	2.917	.044	5	y	53.985	138.15	3.373	21.98	1.1... H1-1b
151	2	M72	C6x10.5	.102	2.031	.044	0	y	53.985	138.15	3.373	21.983	1.1... H1-1b
152	2	M73	C6x10.5	.100	2.917	.044	5	y	53.985	138.15	3.373	22.07	1.1... H1-1b
153	2	M74	C6x10.5	.102	2.031	.044	0	y	53.985	138.15	3.373	21.983	1.1... H1-1b
154	2	M75	C6x10.5	.099	2.917	.044	5	y	53.985	138.15	3.373	21.98	1.1... H1-1b
155	2	M76	C6x10.5	.102	1.927	.044	0	y	53.985	138.15	3.373	21.955	1.1... H1-1b
156	2	M77	C6x10.5	.099	2.917	.045	5	y	53.985	138.15	3.373	21.913	1.1... H1-1b
157	2	M78	C6x10.5	.103	1.875	.045	0	y	53.985	138.15	3.373	21.894	1.1... H1-1b
158	2	M79	HSS3.5...	.068	3.177	.026	5	y	155.9...	184.05	17.588	17.588	1.1... H1-1b

↖ ALL ≤ 1.0