

Old Town Eden Condominiums

An Expandable Utah Condominium Project
 A Part of Section 35, Township 7 North, Range 1 East, SLB&M
 Eden, Weber County, Utah
 November 2016

SURVEYOR'S CERTIFICATE

I, Andy Hubbard, do hereby certify that I am a Professional Land Surveyor in the State of Utah, and that I hold Certificate No. 6242920 in accordance with Title 58, Chapter 22, of the Professional Engineers and Land Surveyors Licensing Act. I also certify that I have completed a survey of the property described herein in accordance with Section 17-23-17 and that I have verified all measurements shown hereon this plat of Old Town Eden Condominiums, in Eden, Weber County, Utah and that it has been correctly drawn to the designated scale and is a true and correct representation of the following description of lands included in said subdivision, based on data compiled from records in the Weber County Recorder's Office. Monuments have been found or placed as represented on this plat. I furthermore certify that all lots within this Subdivision hereby meet all current lot width and area requirements of the Weber County Zoning Ordinance.

Signed this _____ day of _____, 2016.

NARRATIVE

This survey was requested by Mr Ben Toone for the purpose of preparing a Condominium Plat on the subject property.

A line bearing $S 89^{\circ}15'29'' E$ between the Southwest corner and the Southeast corner of the Southwest Quarter of Section 35, T7N, R1E, SLB&M Was used as the Basis of bearings.

Right of way plans for SR-166 (5500 East) were acquired from UDOT Region 1 for Project S-242(1). Sheet 3 shows the pertinent information to locate the right of way.

A Right of way marker was found on the West side of 5500 East Street, and was used to aide in the positioning of the right of way in a East-west direction.

Using the information shown on the plans ties to Existing structures were checked and found to be in tolerance. Angular information was also checked on the plan and was found to generally conform to the plan information, once the location for 5500 East Street was established.

A strong metallic signal under asphalt paving was found on the East side of the right of way perpendicular to the found monument on the West side. The Property owner mentioned he remembered a monument at that location but that it had been paved over a few years ago.

A right of way monument was also found at the Northwest corner of the intersection of 2200 North and 5500 East Streets, but it did not fit nor check with the established location of the right of way or occupation of 5500 East Street.

The North line of the property was established from occupational evidence and by extending the North line of E.P. Subdivision.

The East line of the property was established adjacent to the West line of line of E.P. Subdivision.

The South line of the Property was established along the North line of 2200 North Street. The Centerline of 2200 North Street was established from information provided by the Weber County Surveyor's Office, which is based on the original Eden Township deeds and conveyances. Once Offset the North right of way line generally fits the location shown on a record of survey drawing for Gale Armstrong.

The South line of the Property was established along the North line of 2200 North Street. The Centerline of 2200 North Street was established from information provided by the Weber County Surveyor's Office, which is based on the original Eden Township deeds and conveyances. Once Offset the North right of way line generally fits the location shown on a record of survey drawing for Gale Armstrong.

The South line of the Property was established along the North line of 2200 North Street. The Centerline of 2200 North Street was established from information provided by the Weber County Surveyor's Office, which is based on the original Eden Township deeds and conveyances. Once Offset the North right of way line generally fits the location shown on a record of survey drawing for Gale Armstrong.

The South line of the Property was established along the North line of 2200 North Street. The Centerline of 2200 North Street was established from information provided by the Weber County Surveyor's Office, which is based on the original Eden Township deeds and conveyances. Once Offset the North right of way line generally fits the location shown on a record of survey drawing for Gale Armstrong.

The South line of the Property was established along the North line of 2200 North Street. The Centerline of 2200 North Street was established from information provided by the Weber County Surveyor's Office, which is based on the original Eden Township deeds and conveyances. Once Offset the North right of way line generally fits the location shown on a record of survey drawing for Gale Armstrong.

The South line of the Property was established along the North line of 2200 North Street. The Centerline of 2200 North Street was established from information provided by the Weber County Surveyor's Office, which is based on the original Eden Township deeds and conveyances. Once Offset the North right of way line generally fits the location shown on a record of survey drawing for Gale Armstrong.

This is to certify that this subdivision plat was duly approved by the Weber County Planning Commission.

Signed this _____ day of _____, 2016.

Chairman, Weber County Planning Commission

WEBER COUNTY COMMISSION ACCEPTANCE

This is to certify that this subdivision plat, the dedication of streets and other public ways and financial guarantee of public improvements associated with this subdivision, thereon are hereby approved and will be accepted by the Commissioners of Weber County, Utah this _____ day of _____, 20_____.

Chairman, Weber County Commission

Attest: _____
 Title: _____

WEBER COUNTY ATTORNEY

I have examined the financial guarantee and other documents associated with this subdivision plat, and in my opinion they conform with the County Ordinance applicable hereto and now in force and effect.

Signed this _____ day of _____, 2016.

Weber County Attorney

6242920
 License No.

Andy Hubbard

OWNER'S DEDICATION

Know all men by these presents that I/we, the undersigned owner(s) of the hereon described tract of land, hereby set apart and subdivide the same into lots and streets as shown on this plat and name said plat

Old Town Eden Condominiums and do hereby dedicate, grant and convey to Weber County, Utah: (1) Grant and dedicate a perpetual right and easement over, upon and under the lands designated hereon as public utility, storm water detention ponds, drainage easements and canal maintenance easement, the same to be used for the installation maintenance and operation of Public Utility service lines, storm drainage facilities, irrigation canals for the perpetual preservation of water channels erected within such easements and (2) Grant and convey the Subdivision Lot (unit) for owners association, all those parts or portions of said tract of land designated as common areas to be used for recreational and open space purposes for the benefit of each lot (unit) owners association member in common with all others in the subdivision and grant and dedicate to the county a perpetual open space right and easement on and over the common areas to guarantee to Weber County that the common areas remain open and undeveloped except for approved recreational, parking and open space purposes. We have hereunto set our hands this _____ day of _____, 20_____.

Old Town Eden LLC

Ben Toone - Managing Member

ACKNOWLEDGMENT

State of Utah
 County of _____ } ss

The foregoing instrument was acknowledged before me this _____ day of _____, 2016 by _____.

Residing At: _____

Commission Number: _____

Commission Expires: _____

A Notary Public commissioned in Utah

Print Name

BOUNDARY DESCRIPTION

A part of the Southwest Quarter of Section 35, Township 7 North, Range 1 East, Salt Lake Base and Meridian, U.S. Survey, Eden, Weber County, Utah.

Beginning at the Intersection of the North right of way line of 2200 North Street (established from Record of Survey #0764) and the East line of State Highway 166 (5500 East Street) said point is 2074.21 feet North $0^{\circ}18'51'' E$ East along the Section line and 144.08 feet South $89^{\circ}41'09'' E$ East from the Southwest corner of said Quarter Section, and running thence North $02^{\circ}10'53'' E$ East 302.23 feet along said East right of way line to the North line extended of E.P. Subdivision, in Weber County, Utah; thence South $88^{\circ}49'36'' E$ East 194.77 feet along said North line extended to the Northwest corner of said E.P. Subdivision; thence South $01^{\circ}06'53'' W$ West 303.91 feet along the West line of said E.P. Subdivision to said North right of way line of 2200 North Street; thence North $88^{\circ}20'03'' W$ West 200.41 feet along said North right of way line to the Point of Beginning.

Containing 59,880 square feet
 or 1.3746 acres, more or less.

WEBER COUNTY SURVEYOR

I hereby certify that the Weber County Surveyor's Office has reviewed this plat for mathematical correctness, section corner data, and for harmony with lines and monument on record in County Offices. The approval of this plat by the Weber County Surveyor does not relieve the licensed Land Surveyor who executed this plat from the responsibilities and/or liabilities associated therewith.

Signed this _____ day of _____, 2016.

Weber County Surveyor

NOTES:

1. Each condominium unit contained within the project is shown and is designated by one of the following:

- Unit, consisting of 4 Units followed by a unit number (See Sheets 2 thru 4).
- General Common areas and facilities - [Symbol]
- Private ownership - [Symbol]
- Limited common areas and facilities - [Symbol]
- Convertible Space - [Symbol]

2. All patios, decks, or balconies, contained within the project are considered Limited Common Areas. They are set aside and reserved for the use of the respective condominium unit to which they are attached and/or appurtenant.

3. All other areas contained within the project, but not shown with diagonal stripe or cross hatched lines are considered Common Area, including sanitary sewer drain field area.

4. Dimensions on Sheet 1 are to exterior foundation only.

5. All Common Area is considered to be an easement for public utility and drainage purposes.

6. Convertible Lands shall not occur after 5 years from the recording of the declaration (or shorter if specified in declaration) unless $\frac{3}{4}$ of unit owners vote in favor of conversion.

7. Due to the property at the location of this Subdivision, Lot Owners within the Development will accept responsibility for any storm water run off for roads adjacent to this property until curb and gutter is installed.

Sheet 1 of 5

WEBER COUNTY RECORDER

ENTRY NO. _____ FEE PAID _____
 RECORDED _____ FILED FOR RECORD AND AT _____
 IN BOOK _____ OF OFFICIAL RECORDS, PAGE _____ RECORDED FOR _____

WEBER COUNTY RECORDER

BY: _____ DEPUTY

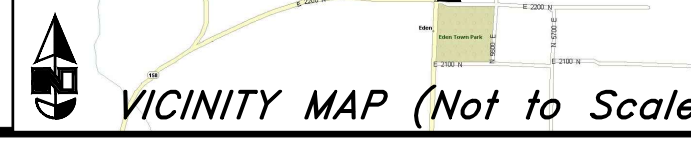
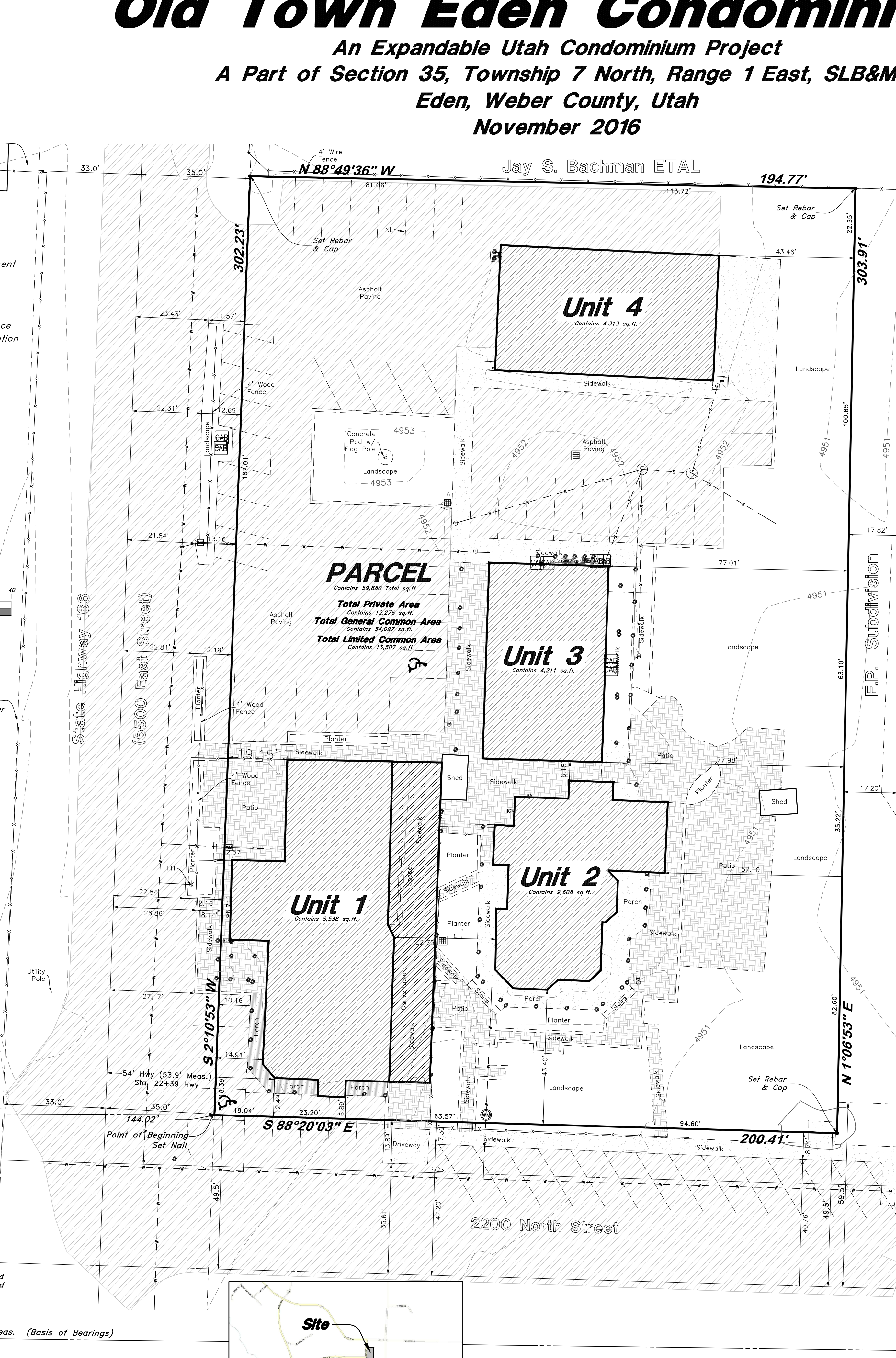
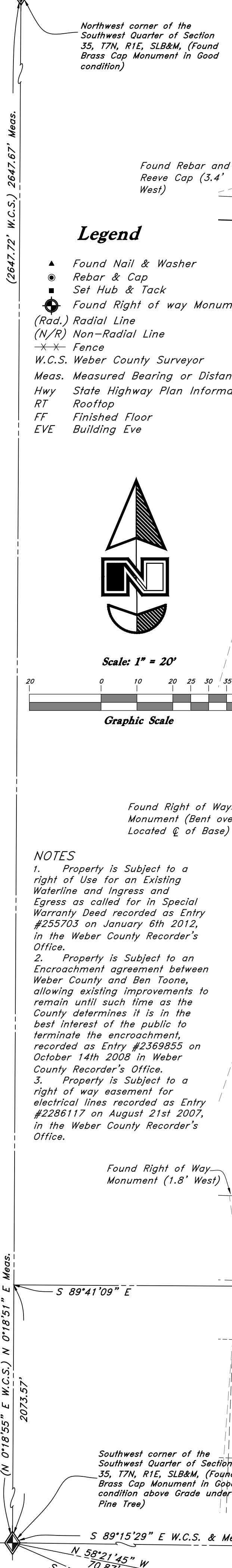

GREAT BASIN ENGINEERING
 5746 SOUTH 1475 EAST OGDEN, UTAH 84403
 MAIN (801)394-4515 S.L.C (801)521-0222 FAX (801)392-7544
 WWW.GREATBASINENGINEERING.COM

ENGINEER:
 Great Basin Engineering, Inc.
 c/o Andy Hubbard
 5746 South 1475 East Suite 200
 Ogden, Utah 84403
 (801) 394-4515

DEVELOPER:
 Ben Toone LLC
 c/o Ben Toone
 5510 East 2200 North
 Eden, UT 84310
 (801) 447-9625

Old Town Eden Condominiums

An Expandable Utah Condominium Project
 A Part of Section 35, Township 7 North, Range 1 East, SLB&M
 Eden, Weber County, Utah
 November 2016

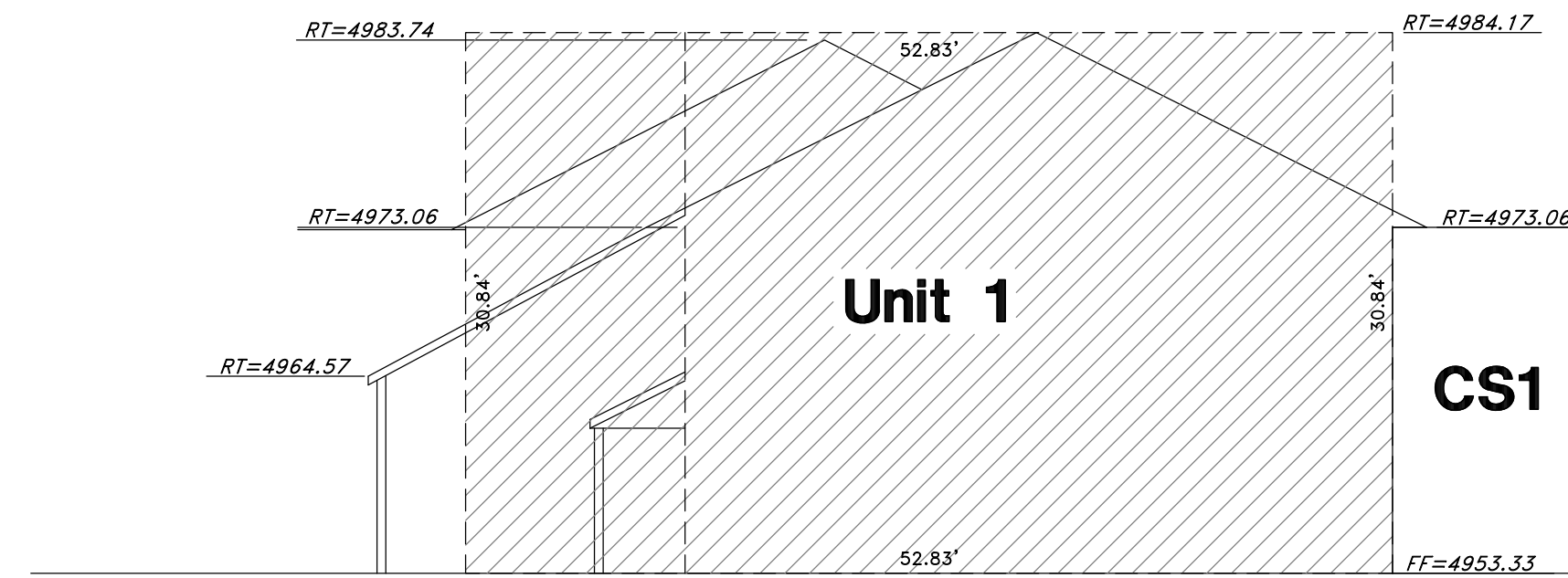
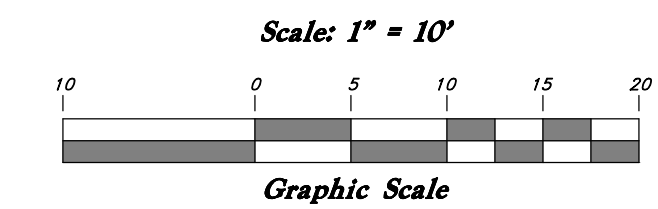
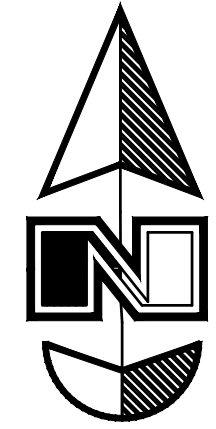

Section A-A

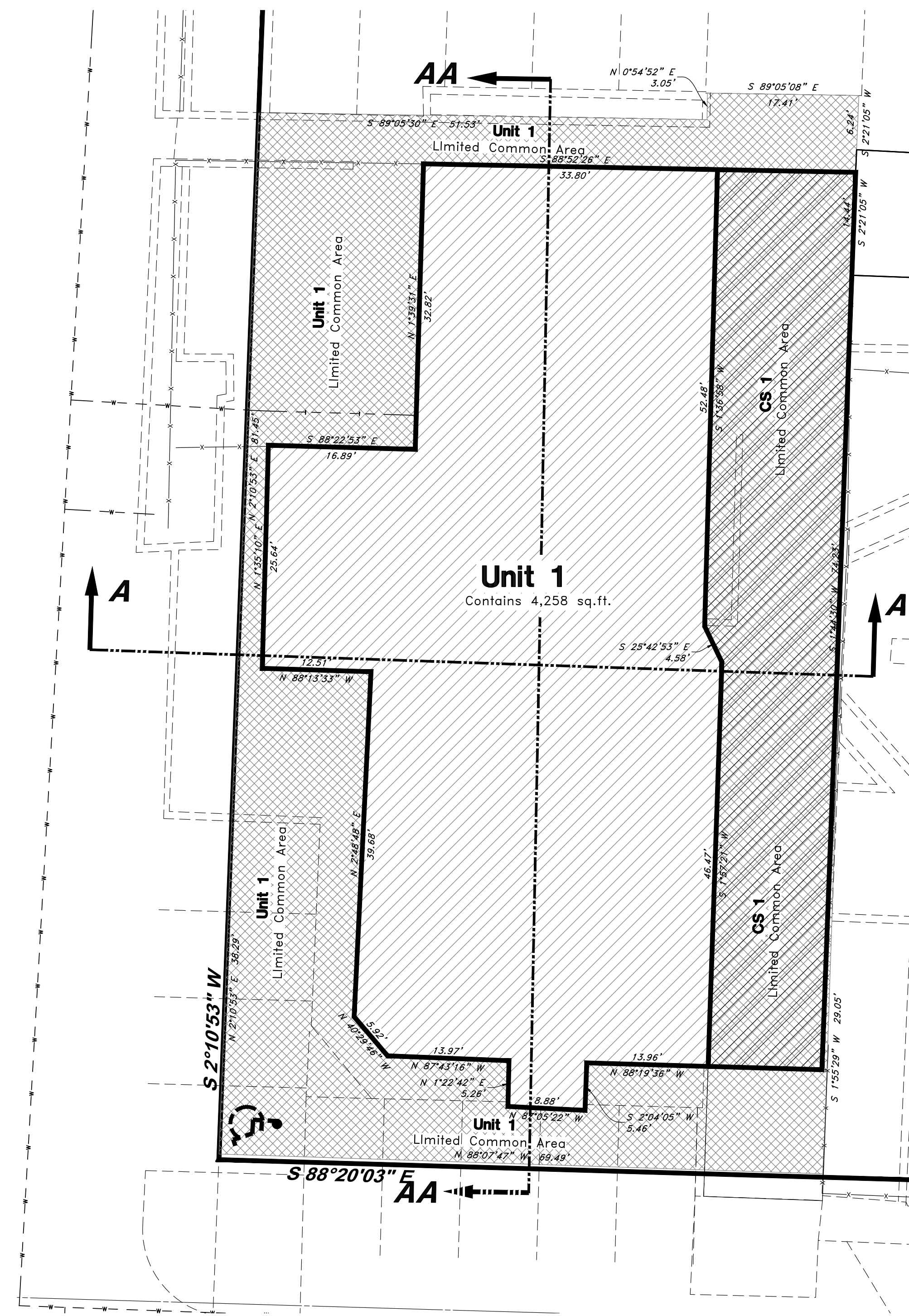

Unit 1

Parking Site Table					
Rental Units	Tenant	Usage	Total Sq. Ft.	Sq. Ft. For Parking	Required Parking
General Store (Restaurant Main Level)	Carlos & Harleys	Restaurant	4,258	3,169	1 Space per Table
General Store North (Office Upstairs)	PPR	Real Estate	600	600	1 Space per Two Employees (+4 Spaces for Client Use)
General Store Main (Upstairs Showroom)	PPR	Showroom	1,300	845	0? Unknown Use Defined
General Store (Small Offices Upstairs)	PPR	Office x 4	415	415	1 Space per Employee (+4 Spaces for Client use)
Old Victorian House	Gravitea/Yoga	Tea Bar (No Seating)	1,450	1,141	2 Stools + Yoga Class
Old Victorian House	Dale Smith	Residence	2,446	2,446	2 Side by Side
A Bay	Valley Hair	Hair Salon	800	740	2 Spaces per Staff Member (rarely there all together)
B Bay	Free Spirit Spa	Spa	800	402	2 Spaces per staff Member
C Bay 2/3	Free Spirit Spa	Spa	800	402	Same Business as above
C Bay 1/3	Shan Yao	Therapy	242	144	Single Massage Table
Suite 1 (Full Service)	Citywide Mortgage	Mortgage	288	250	1 Space per Staff Member (+3 for Client Use)
Suite 2 (Full Service)	Envision Homes	Contractors Office	288	250	Single Office of Contractor
Suite 3 (Full Service)	Keller Williams	Real Estate	192	192	1 Space per Two Employees (+4 Spaces for Client Use)
Suite 4 (Full Service)	Leasing Office	Vacant	192	192	
Suite 5 (Full Service)	Citywide Mortgage	Mortgage	192	192	1 Space per Two Employee (+4 Spaces for Client Use)
Suite 6 (Full Service)	Vacant	Office	144	144	
Metal Building	Summit	Warehouse	2,800	2,800	2 Spaces per 3 Employees
Total			17,207	14,324	

Legend

- ▲ Found Nail & Washer
- Rebar & Cap
- Set Hub & Tack
- ⊕ Found Right of way Monument
- (Rad.) Radial Line
- (N/R) Non-Radial Line
- - - Fence
- W.C.S. Weber County Surveyor
- Meas. Measured Bearing or Distance
- Hwy State Highway Plan Information
- RT Rooftop
- FF Finished Floor
- EVE Building Eve

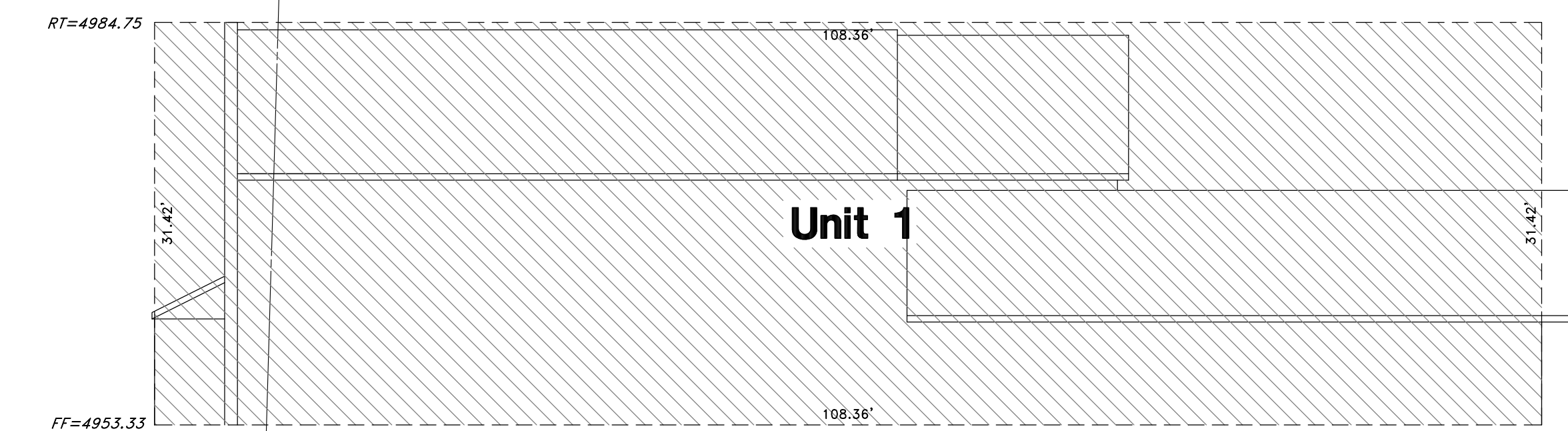

Section AA-AA

NOTES:

1. Each condominium unit contained within the project is as shown and is designated by one of the following:
 Unit, consisting of 4 Units followed by a unit number (See Sheets 2 thru 4).
 General Common areas and facilities -
 Private ownership -
 Limited common areas and facilities -
 Convertible Space -
2. All patios, decks, or balconies, contained within the project are considered Limited Common Areas. They are set aside and reserved for the use of the respective condominium unit to which they are attached and/or appurtenant.
3. All other areas contained within the project, but not shown with diagonal stripe or cross hatched lines are considered Common Area, including sanitary sewer drain field area.
4. Dimensions on Sheet 1 are to exterior foundation only.
5. All Common Area is considered to be an easement for public utility and drainage purposes.
6. Convertible Lands shall not occur after 5 years from the recording of the declaration (or shorter if specified in declaration) unless 3/4 of unit owners vote in favor of conversion.

GREAT BASIN ENGINEERING
 5746 SOUTH 1475 EAST OGDEN, UTAH 84403
 MAIN (801)394-4515 S.L.C (801)521-0222 FAX (801)392-7544
 WWW.GREATBASINENGINEERING.COM

WEBER COUNTY RECORDER
 ENTRY NO. _____ FEE PAID _____
 RECORDED _____ FILED FOR RECORD AND
 _____ AT _____
 IN BOOK _____ OF OFFICIAL
 RECORDS, PAGE _____ RECORDED
 FOR _____
 WEBER COUNTY RECORDER
 BY: _____ DEPUTY _____

Old Town Eden Condominiums

An Expandable Utah Condominium Project
 A Part of Section 35, Township 7 North, Range 1 East, SLB&M
 Eden, Weber County, Utah
 November 2016

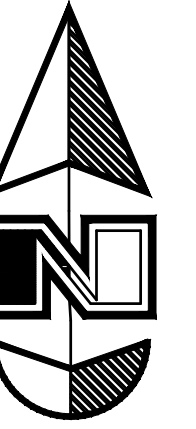
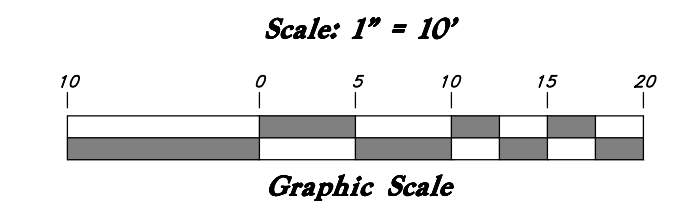

Line	Bearing	Length
L1	N 2°03'10" E	15.75
L2	S 87°56'50" E	3.46
L3	N 45°05'18" E	7.00
L4	S 12°04'44" W	1.56
L5	S 70°47'18" E	2.97
L6	S 54°38'16" E	1.34
L7	N 67°52'25" E	0.46
L8	S 86°32'40" E	12.14
L9	S 3°45'15" W	19.26
L10	N 86°23'29" E	4.76
L11	S 3°36'31" E	8.09
L12	S 87°09'43" W	6.99
L13	S 4°20'53" W	50.64
L14	N 86°02'16" W	27.03
L15	S 3°57'44" W	11.98
L16	N 87°13'57" W	10.37
L17	S 4°28'37" W	15.33
L18	N 87°11'43" W	24.97
L19	S 2°38'06" W	2.90
L20	N 87°21'54" W	9.78

Line	Bearing	Length
L21	N 2°40'09" E	2.97
L22	N 87°43'21" W	11.67
L23	S 1°50'04" W	1.73
L24	N 86°31'15" W	5.93
L25	S 2°00'03" W	5.97
L26	S 88°41'09" E	9.65
L27	S 1°12'50" W	4.62
L28	N 87°58'34" W	9.82
L29	S 2°23'49" W	13.75
L30	N 88°07'47" W	5.82
L31	N 2°33'00" E	29.00
L32	N 87°49'30" W	9.07
L33	N 1°44'30" E	74.23
L34	N 2°21'05" E	14.44
L35	S 86°59'58" E	8.39
L36	S 2°19'50" W	0.70
L37	S 88°07'39" E	4.64
L38	S 88°07'39" E	38.38
L39	S 87°11'00" E	8.83

Curve	Delta	Radius	Length	Chord	Chord Bearing
C1	92°34'04"	4.25	6.87	6.14'	N 88°08'28" E
C2	50°27'24"	7.33	6.46	6.25'	S 20°20'48" E
C3	58°19'41"	1.89	1.92	1.84'	S 1°51'32" E
C4	52°38'35"	9.13	8.39	8.10'	S 57°20'41" E
C5	37°35'19"	17.94	11.77	11.56'	N 58°27'30" E

Legend

- ▲ Found Nail & Washer
- Rebar & Cap
- Set Hub & Tack
- ⊕ Found Right of way Monument
- (Rad.) Radial Line
- (N/R) Non-Radial Line
- - - Fence
- W.C.S. Weber County Surveyor
- Meas. Measured Bearing or Distance
- Hwy State Highway Plan Information
- RT Rooftop
- FF Finished Floor
- EVE Building Eve

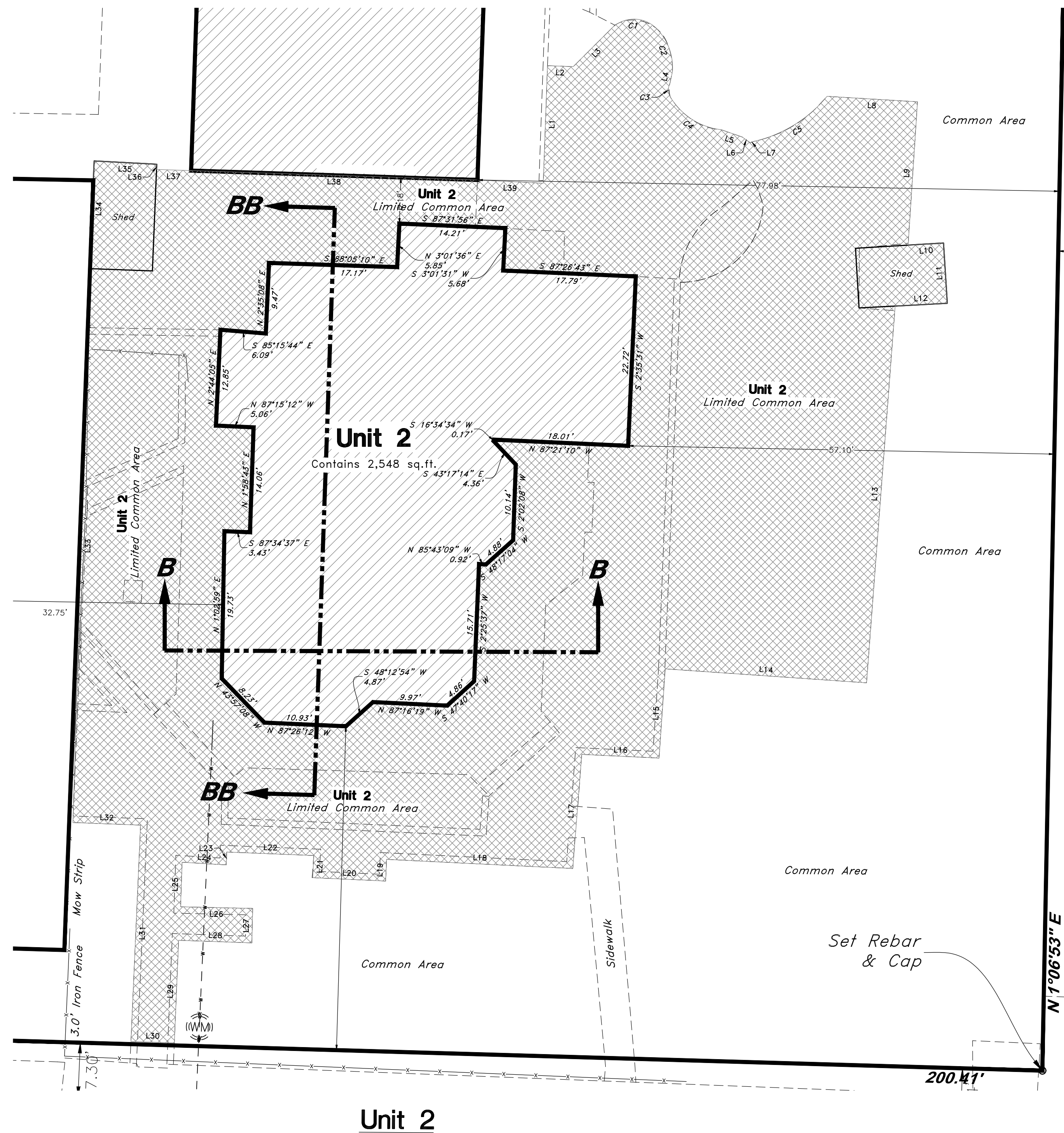

Parking Site Table					
Rental Units	Tenant	Usage	Total Sq. Ft.	Sq. Ft. For Parking	Required Parking
General Store (Restaurant Main Level)	Carlos & Harleys	Restaurant	4,258	3,169	1 Space per Table
General Store North (Office Upstairs)	PPR	Real Estate	600	600	1 Space per Two Employees (+4 Spaces for Client Use)
General Store Main (Upstairs Showroom)	PPR	Showroom	1,300	845	0? Unknown Use Defined
General Store (Small Offices Upstairs)	PPR	Office x 4	415	415	1 Space per Employee (+4 Spaces for Client use)
Old Victorian House	Gravitea/Yoga	Tea Bar (No Seating)	1,450	1,141	2 Stools + Yoga Class
Old Victorian House	Dale Smith	Residence	2,446	2,446	2 Side by Side
A Bay	Valley Hair	Hair Salon	800	740	2 Spaces per Staff Member (rarely there all together)
B Bay	Free Spirit Spa	Spa	800	402	2 Spaces per staff Member
C Bay 2/3	Free Spirit Spa	Spa	800	402	Same Business as above
C Bay 1/3	Shan Yao	Therapy	242	144	Single Massage Table
Suite 1 (Full Service)	Citywide Mortgage	Mortgage	288	250	1 Space per Staff Member (+3 for Client Use)
Suite 2 (Full Service)	Envision Homes	Contractors Office	288	250	Single Office of Contractor
Suite 3 (Full Service)	Keller Williams	Real Estate	192	192	1 Space per Two Employees (+4 Spaces for Client Use)
Suite 4 (Full Service)	Leasing Office	Vacant	192	192	
Suite 5 (Full Service)	Citywide Mortgage	Mortgage	192	192	1 Space per Two Employees (+4 Spaces for Client Use)
Suite 6 (Full Service)	Vacant	Office	144	144	
Metal Building	Summit	Warehouse	2,800	2,800	2 Spaces per 3 Employees
Total			17,207	14,324	

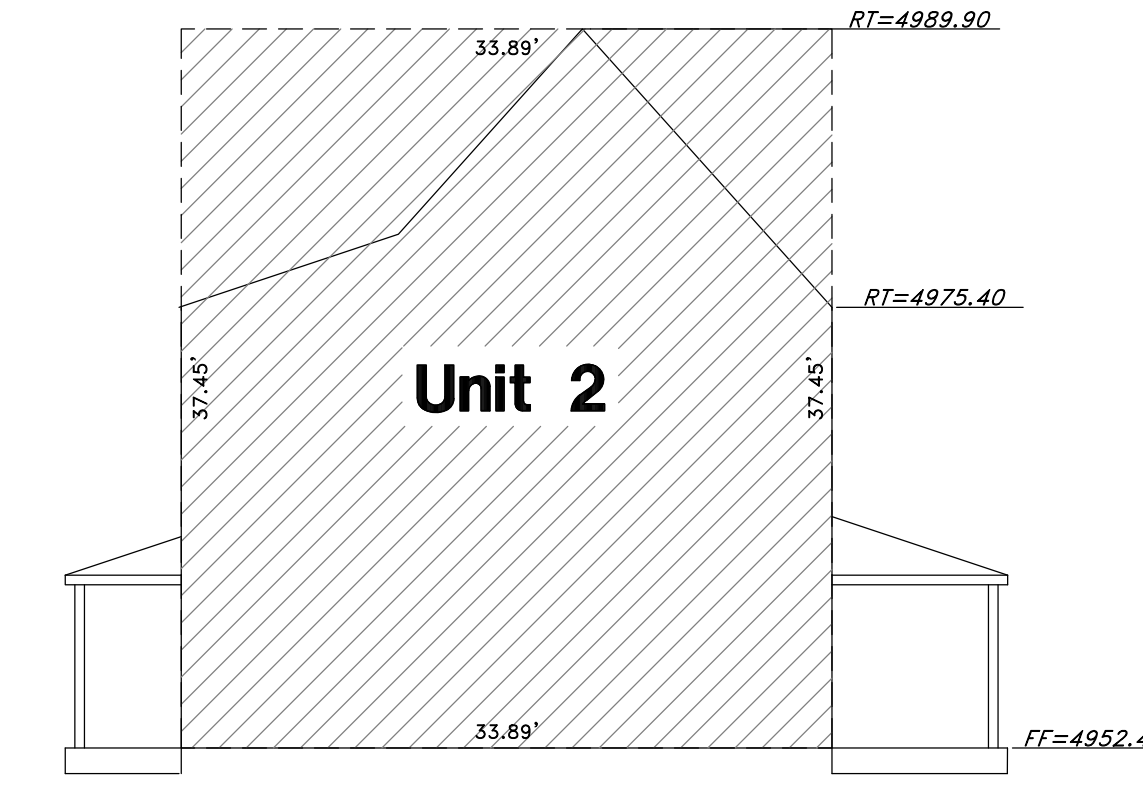

Section B-B

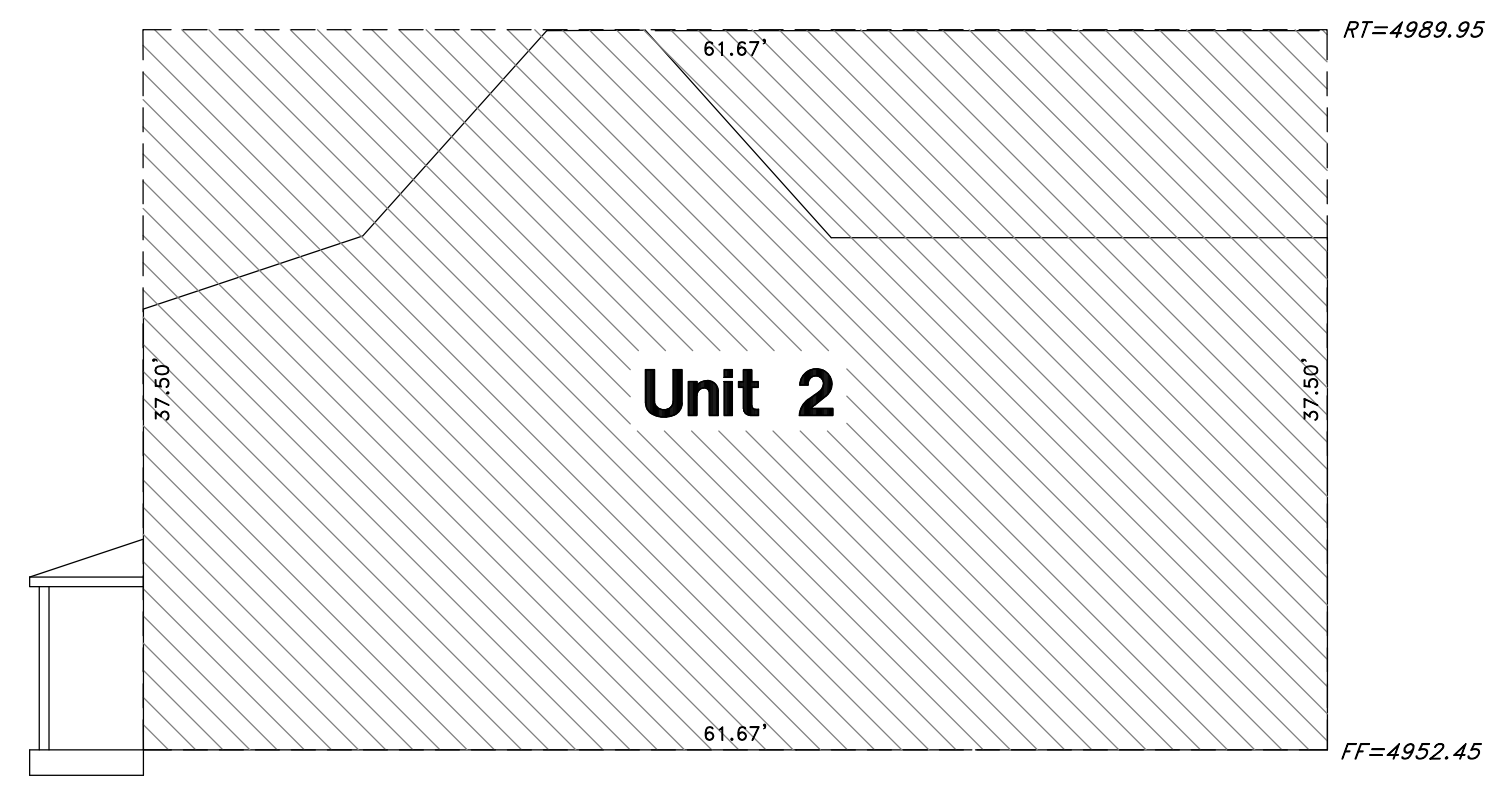

Section BB-BB

- NOTES:**
- Each condominium unit contained within the project is as shown and is designated by one of the following:
 Unit, consisting of 4 Units followed by a unit number (See Sheets 2 thru 4).
 General Common areas and facilities -
 Private ownership -
 Limited common areas and facilities -
 Convertible Space -
 - All patios, decks, or balconies, contained within the project are considered Limited Common Areas. They are set aside and reserved for the use of the respective condominium unit to which they are attached and/or appurtenant.
 - All other areas contained within the project, but not shown with diagonal stripes or cross hatched lines are considered Common Area, including sanitary sewer drain field area.
 - Dimensions on Sheet 1 are to exterior foundation only.
 - All Common Area is considered to be an easement for public utility and drainage purposes.
 - Convertible Lands shall not occur after 5 years from the recordation of the declaration (or shorter if specified in declaration) unless 3/4 of unit owners vote in favor of conversion.

Sheet 3 of 5

GREAT BASIN ENGINEERING
 5746 SOUTH 1475 EAST OGDEN, UTAH 84403
 MAIN (801)394-4515 S.L.C (801)521-0222 FAX (801)392-7544
 WWW.GREATBASINENGINEERING.COM

WEBER COUNTY RECORDER
 ENTRY NO. _____ FEE PAID _____
 RECORDED _____ FILED FOR RECORD AND
 IN BOOK _____ OF OFFICIAL
 RECORDS, PAGE _____ RECORDED
 FOR _____
 WEBER COUNTY RECORDER
 BY: _____ DEPUTY

Old Town Eden Condominiums

An Expandable Utah Condominium Project
 A Part of Section 35, Township 7 North, Range 1 East, SLB&M
 Eden, Weber County, Utah
 November 2016

Legend

- ▲ Found Nail & Washer
- Rebar & Cap
- Set Hub & Tack
- ◆ Found Right of way Monument
- (Rad.) Radial Line
- (N/R) Non-Radial Line
- - - Fence
- W.C.S. Weber County Surveyor
- Meas. Measured Bearing or Distance
- Hwy State Highway Plan Information
- RT Rooftop
- FF Finished Floor
- EVE Building Eve

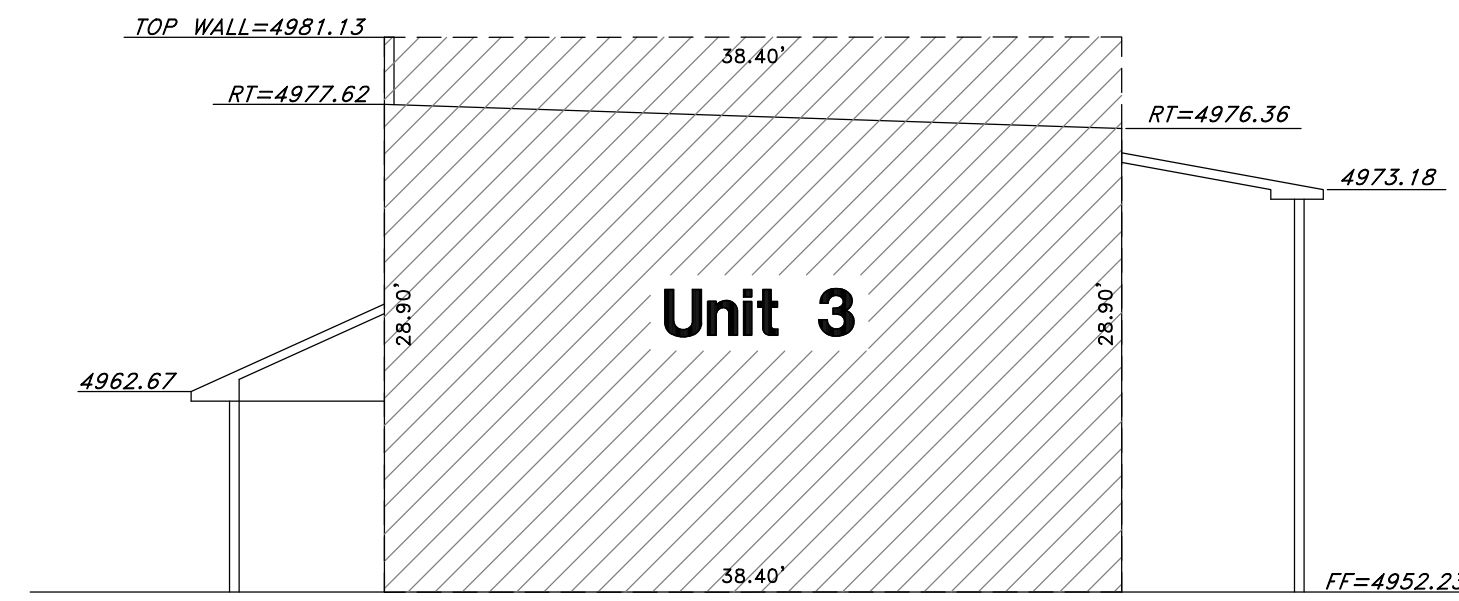
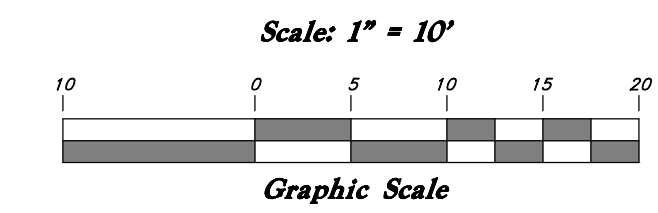
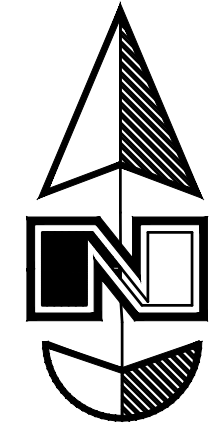

Section C-C

Parking Site Table					
Rental Units	Tenant	Usage	Total Sq. Ft.	Sq. Ft. For Parking	Required Parking
General Store (Restaurant Main Level)	Carlos & Harleys	Restaurant	4,258	3,169	1 Space per Table
General Store North (Office Upstairs)	PPR	Real Estate	600	600	1 Space per Two Employees (+4 Spaces for Client Use)
General Store Main (Upstairs Showroom)	PPR	Showroom	1,300	845	0? Unknown Use Defined
General Store (Small Offices Upstairs)	PPR	Office x 4	415	415	1 Space per Employee (+4 Spaces for Client use)
Old Victorian House	Gravitea/Yoga	Tea Bar (No Seating)	1,450	1,141	2 Stools + Yoga Class
Old Victorian House	Dale Smith	Residence	2,446	2,446	2 Side by Side
A Bay	Valley Hair	Hair Salon	800	740	2 Spaces per Staff Member (rarely there all together)
B Bay	Free Spirit Spa	Spa	800	402	2 Spaces per staff Member
C Bay 2/3	Free Spirit Spa	Spa	800	402	Same Business as above
C Bay 1/3	Shan Yao	Therapy	242	144	Single Massage Table
Suite 1 (Full Service)	Citywide Mortgage	Mortgage	288	250	1 Space per Staff Member (+3 for Client Use)
Suite 2 (Full Service)	Envision Homes	Contractors Office	288	250	Single Office of Contractor
Suite 3 (Full Service)	Keller Williams	Real Estate	192	192	1 Space per Two Employees (+4 Spaces for Client Use)
Suite 4 (Full Service)	Leasing Office	Vacant	192	192	
Suite 5 (Full Service)	Citywide Mortgage	Mortgage	192	192	1 Space per Two Employee (+4 Spaces for Client Use)
Suite 6 (Full Service)	Vacant	Office	144	144	
Metal Building	Summit	Warehouse	2,800	2,800	2 Spaces per 3 Employees
Total			17,207	14,324	

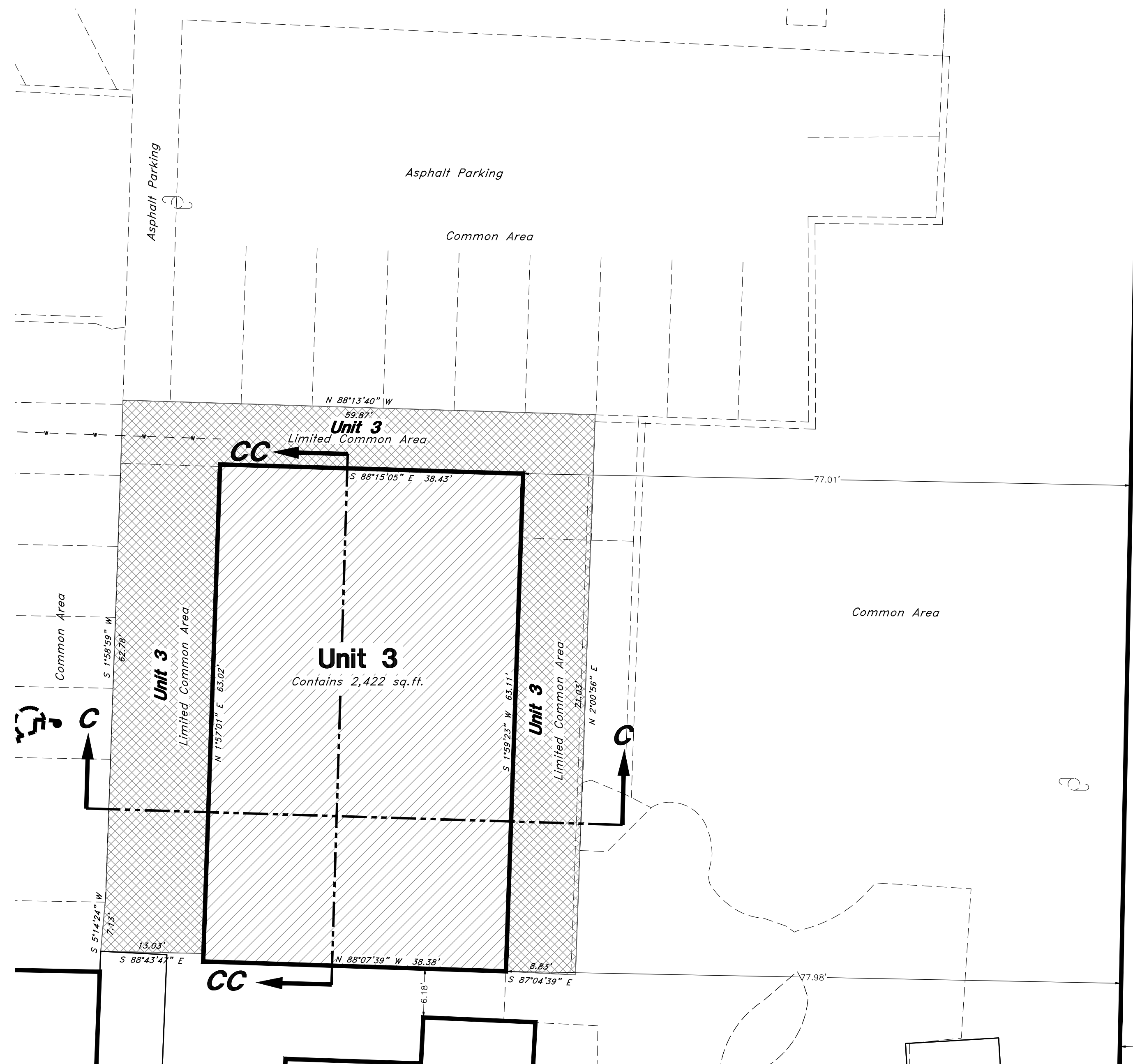

Unit 3

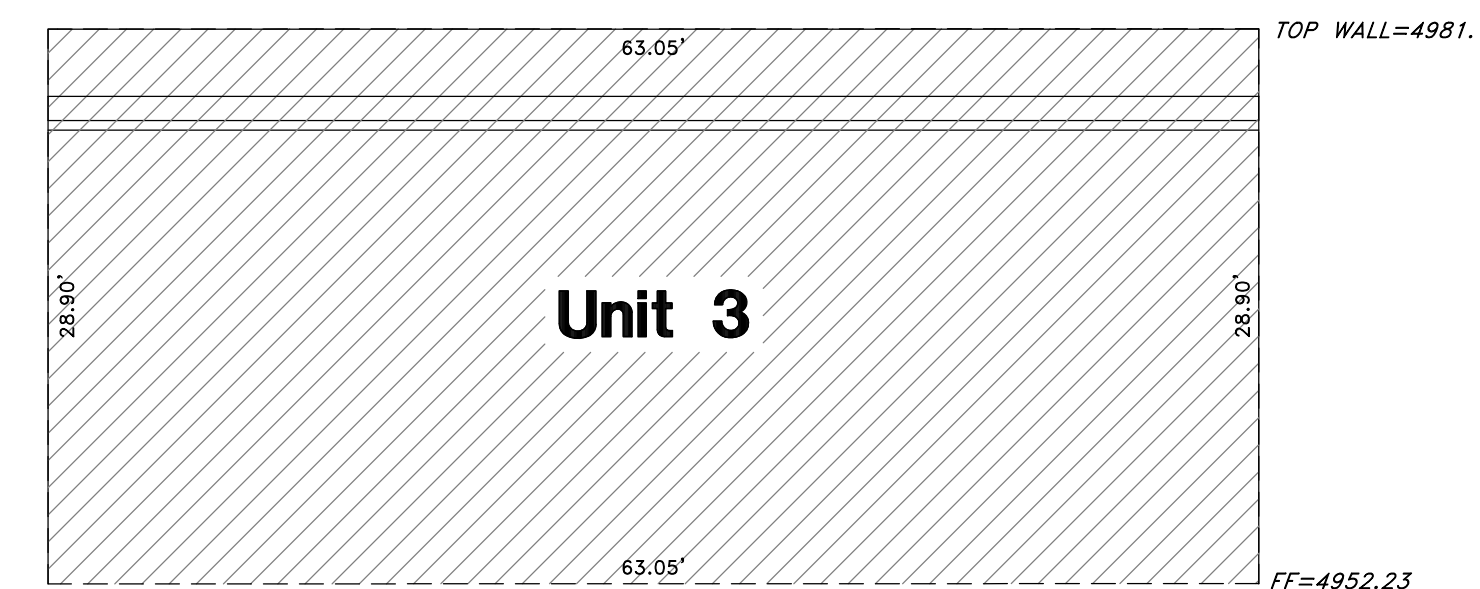

Section CC-CC

NOTES:

- Each condominium unit contained within the project is shown and is designated by one of the following:
 Unit, consisting of 4 Units followed by a unit number (See Sheets 2 thru 4).
 General Common areas and facilities -
 Private ownership -
 Limited common areas and facilities -
 Convertible Space -
- All patios, decks, or balconies, contained within the project are considered Limited Common Areas. They are set aside and reserved for the use of the respective condominium unit to which they are attached and/or appurtenant.
- All other areas contained within the project, but not shown with diagonal stripe or cross hatched lines are considered Common Area, including sanitary sewer drain field area.
- Dimensions on Sheet 1 are to exterior foundation only.
- All Common Area is considered to be an easement for public utility and drainage purposes.
- Convertible Lands shall not occur after 5 years from the recordation of the declaration (or shorter if specified in declaration) unless 3/4 of unit owners vote in favor of conversion.

GREAT BASIN ENGINEERING
 5746 SOUTH 1475 EAST OGDEN, UTAH 84403
 MAIN (801)394-4515 S.L.C (801)521-0222 FAX (801)392-7544
 WWW.GREATBASINENGINEERING.COM

Sheet 4 of 5

WEBER COUNTY RECORDER
 ENTRY NO. _____ FEE PAID _____
 RECORDED _____ FILED FOR RECORD AND
 _____ AT _____
 IN BOOK _____ OF OFFICIAL
 RECORDS, PAGE _____ RECORDED
 FOR _____
 WEBER COUNTY RECORDER
 BY: _____ DEPUTY _____

Old Town Eden Condominiums

An Expandable Utah Condominium Project
 A Part of Section 35, Township 7 North, Range 1 East, SLB&M
 Eden, Weber County, Utah
 November 2016

Legend

- ▲ Found Nail & Washer
- Rebar & Cap
- ⊙ Set Hub & Tack
- ⊕ Found Right of way Monument
- (Rad.) Radial Line
- (N/R) Non-Radial Line
- X-X- Fence
- W.C.S. Weber County Surveyor
- Meas. Measured Bearing or Distance
- Hwy State Highway Plan Information
- RT Rooftop
- FF Finished Floor
- EVE Building Eve

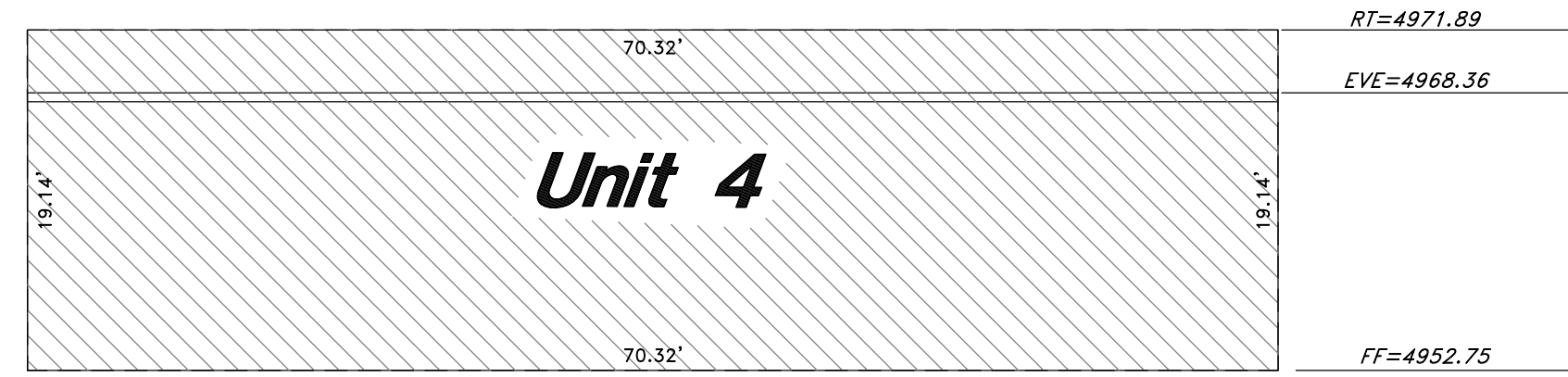
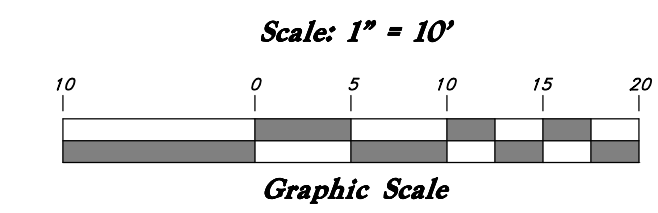
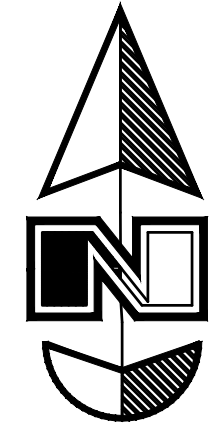

Unit 4

Section C-C

Parking Site Table					
Rental Units	Tenant	Usage	Total Sq. Ft.	Sq. Ft. For Parking	Required Parking
General Store (Restaurant Main Level)	Carlos & Harleys	Restaurant	4,258	3,169	1 Space per Table
General Store North (Office Upstairs)	PPR	Real Estate	600	600	1 Space per Two Employees (+4 Spaces for Client Use)
General Store Main (Upstairs Showroom)	PPR	Showroom	1,300	845	0? Unknown Use Defined
General Store (Small Offices Upstairs)	PPR	Office x 4	415	415	1 Space per Employee (+4 Spaces for Client use)
Old Victorian House	Gravitea/Yoga	Tea Bar (No Seating)	1,450	1,141	2 Stools + Yoga Class
Old Victorian House	Dale Smith	Residence	2,446	2,446	2 Side by Side
A Bay	Valley Hair	Hair Salon	800	740	2 Spaces per Staff Member (rarely there all together)
B Bay	Free Spirit Spa	Spa	800	402	2 Spaces per staff Member
C Bay 2/3	Free Spirit Spa	Spa	800	402	Same Business as above
C Bay 1/3	Shan Yao	Therapy	242	144	Single Massage Table
Suite 1 (Full Service)	Citywide Mortgage	Mortgage	288	250	1 Space per Staff Member (+3 for Client Use)
Suite 2 (Full Service)	Envision Homes	Contractors Office	288	250	Single Office of Contractor
Suite 3 (Full Service)	Keller Williams	Real Estate	192	192	1 Space per Two Employees (+4 Spaces for Client Use)
Suite 4 (Full Service)	Leasing Office	Vacant	192	192	
Suite 5 (Full Service)	Citywide Mortgage	Mortgage	192	192	1 Space per Two Employee (+4 Spaces for Client Use)
Suite 6 (Full Service)	Vacant	Office	144	144	
Metal Building	Summit	Warehouse	2,800	2,800	2 Spaces per 3 Employees
Total			17,207	14,324	

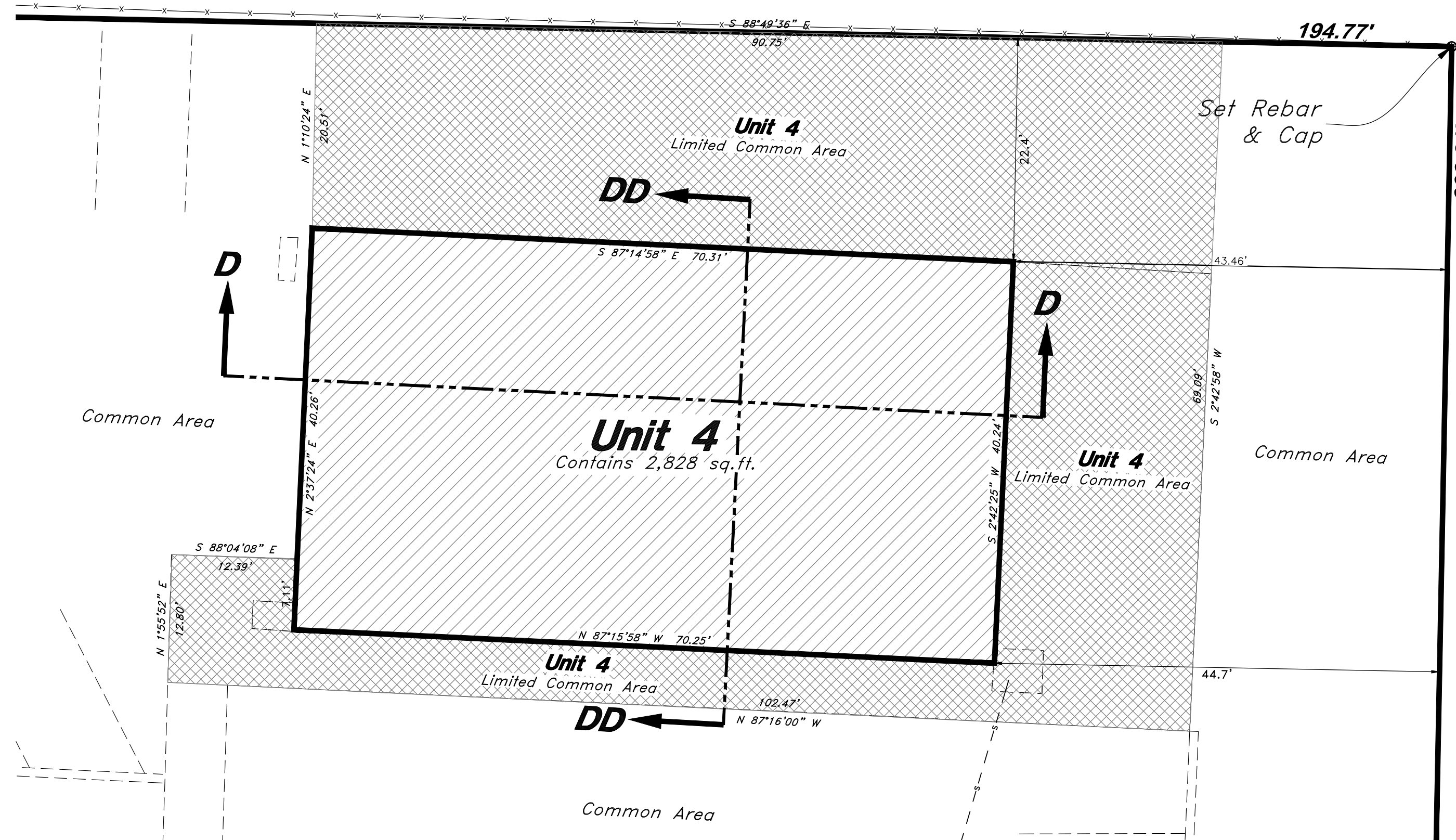

Unit 4

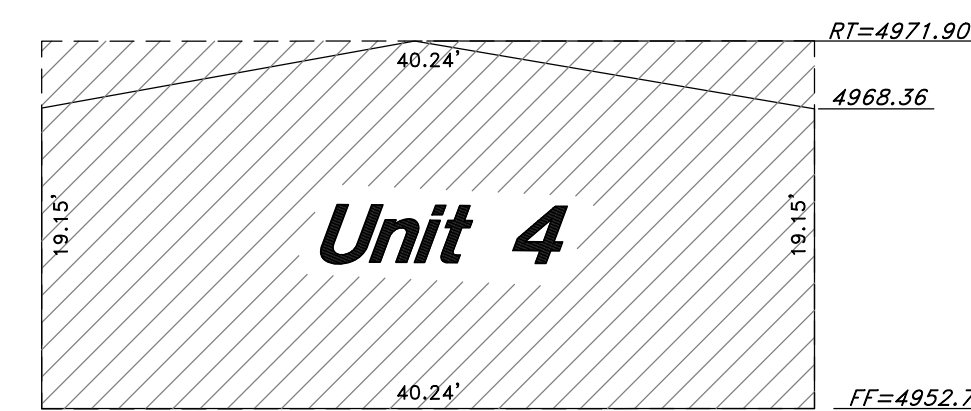

Section DD-DD

NOTES:

- Each condominium unit contained within the project is as shown and is designated by one of the following:
 Unit, consisting of 4 Units followed by a unit number (See Sheets 2 thru 4).
 General Common areas and facilities -
 Private ownership -
 Limited common areas and facilities -
 Convertible Space -
- All patios, decks, or balconies, contained within the project are considered Limited Common Areas. They are set aside and reserved for the use of the respective condominium unit to which they are attached and/or appurtenant.
- All other areas contained within the project, but not shown with diagonal stripe or cross hatched lines are considered Common Area, including sanitary sewer drain field area.
- Dimensions on Sheet 1 are to exterior foundation only.
- All Common Area is considered to be an easement for public utility and drainage purposes.
- Convertible Lands shall not occur after 5 years from the recordation of the declaration (or shorter if specified in declaration) unless 3/4 of unit owners vote in favor of conversion.

GREAT BASIN ENGINEERING
 5746 SOUTH 1475 EAST OGDEN, UTAH 84403
 MAIN (801)394-4515 S.L.C (801)521-0222 FAX (801)392-7544
 WWW.GREATBASINENGINEERING.COM

Sheet 5 of 5

WEBER COUNTY RECORDER
 ENTRY NO. _____ FEE PAID _____
 RECORDED _____, AT _____
 IN BOOK _____ OF OFFICIAL RECORDS, PAGE _____ RECORDED FOR _____
 WEBER COUNTY RECORDER
 BY: _____ DEPUTY