

Old Town Eden Condominiums

An Expandable Utah Condominium Project
 A Part of Section 35, Township 7 North, Range 1 East, SLB&M
 Eden, Weber County, Utah

SURVEYOR'S CERTIFICATE

I, Andy Hubbard, do hereby certify that I am a Professional Land Surveyor in the State of Utah, and that I hold Certificate No. 6242920 in accordance with Title 58, Chapter 22, of the Professional Engineers and Land Surveyors Licensing Act. I also certify that I have completed a survey of the property described hereon in accordance with Section 17-23-17 and that I have verified all measurements shown hereon this plat of Old Town Eden Condominiums, in Eden, Weber County, Utah and that it has been correctly drawn to the designated scale and is a true and correct representation of the following description of lands included in said subdivision, based on data compiled from records in the Weber County Recorder's Office. Monuments have been found or placed as represented on this plat.

Signed this _____ day of _____, 2016.

6242920
 License No.

Andy Hubbard

OWNER'S DEDICATION

Know all men by these presents that I/we, the undersigned owner(s) of the hereon described tract of land, hereby set apart and subdivide the same into lots and streets as shown on this plat and name said plat: Old Town Eden Condominiums and do hereby dedicate, grant and convey to Weber County, Utah: (1) all those parts or portions of said tract of land designated as streets, the same to be used as public thoroughfares forever; (2) those certain public utility and drainage easements as shown hereon, the same to be used for the installation, maintenance, and operations of public utility service lines and drainage; and (3) those parcels designated as public open space, parks, trail, or easements, or of similar designation. In witness whereof, we have hereunto set our hands this _____ day of _____, 20__.

Old Town Eden Condominiums LC????????

Authorized Agent

ACKNOWLEDGMENT

State of Utah } ss
 County of _____

The foregoing instrument was acknowledged before me this _____ day of _____, 2016 by _____.

Residing At: _____ A Notary Public commissioned in Utah

Commission Number: _____

Commission Expires: _____

Print Name

BOUNDARY DESCRIPTION

A part of the Southwest Quarter of Section 35, Township 7 North, Range 1 East, Salt Lake Base and Meridian, U.S. Survey, Eden, Weber County, Utah.

Beginning at the intersection of the North right of way line of 2200 North Street (established from Record of Survey #0764) and the East line of State Highway 166 (5500 East Street) said point is 2074.21 feet North 0°18'51" East along the Section line and 144.08 feet South 89°41'09" East from the Southwest corner of said Quarter Section; and running thence North 02°10'53" East 301.59 feet along said East right of way line to the North line extended of E.P. Subdivision, in Weber County, Utah; thence South 88°49'36" East 194.77 feet along said North line extended to the Northwest corner of said E.P. Subdivision; thence South 01°06'53" West 303.98 feet along the West line of said E.P. Subdivision to said North right of way line of 2200 North Street; thence North 88°07'47" West 200.41 feet along said North right of way line to the Point of Beginning. Containing 59,823 square feet or 1.3733 acres, more or less.

WEBER COUNTY PLANNING COMMISSION APPROVAL

This is to certify that this subdivision plat was duly approved by the Weber County Planning Commission.
 Signed this _____ day of _____, 2016.

Chairman, Weber County Planning Commission

WEBER COUNTY COMMISSION ACCEPTANCE

This is to certify that this subdivision plat, the dedication of streets and other public ways and financial guarantee of public improvements associated with this subdivision, thereon are hereby approved and accepted by the commissioners of Weber County, Utah.
 Signed this _____ day of _____, 2016.

Chairman, Weber County Commission

WEBER COUNTY ATTORNEY

I have examined the financial guarantee and other documents associated with this subdivision plat, and in my opinion they conform with the County Ordinance applicable thereto and now in force and effect.
 Signed this _____ day of _____, 2016.

Weber County Attorney

WEBER COUNTY SURVEYOR

I hereby certify that the Weber County Surveyor's Office has reviewed this plat for mathematical correctness, section corner data, and for harmony with lines and monument on record in County Offices. The approval of this plat by the Weber County Surveyor does not relieve the licensed Land Surveyor who executed this plat from the responsibilities and/or liabilities associated therewith.
 Signed this _____ day of _____, 2016.

Weber County Surveyor

WEBER-MORGAN HEALTH DEPARTMENT

I hereby certify that the soils, percolation rates, and site conditions for this subdivision have been investigated by this office and are approved for on-site wastewater disposal systems.
 Signed this _____ day of _____, 2016.

Director - Weber Morgan Health Department

WEBER COUNTY ENGINEER

I hereby certify that the required public improvement standards and drawings for this subdivision conform with County standards and the amount of the financial guarantee is sufficient for the installation of these improvements.

Weber County Engineer

Sheet 1 of 5

WEBER COUNTY RECORDER

ENTRY NO. _____ FEE PAID _____
 FILED FOR RECORD AND RECORDED _____ AT _____
 IN BOOK _____ OF OFFICIAL RECORDS, PAGE _____ RECORDED FOR _____

WEBER COUNTY RECORDER

BY: _____ DEPUTY

(2647.72' W.C.S.) 2647.67' Meas.

(N 0°18'55" E W.C.S.) N 0°18'51" E Meas. 2074.21

S 89°15'29" E W.C.S. & Meas. (Basis of Bearings) N 58°21'45" W 70.87' S 46°05'45" E 80.21'

Southwest corner of the Southwest Quarter of Section 35, T7N, R1E, SLB&M, (Found Brass Cap Monument in Good condition above Grade under Pine Tree)

Found Rebar and Reeve Cap (3.4' West)

NARRATIVE

This survey was requested by Mr. Ben Toone for the purpose of preparing a Condominium Plat on the subject property.
 A line bearing S 89°15'29" E between the Southwest corner and the Southeast corner of the Southwest Quarter of Section 35, T7N, R1E, SLB&M Was used as the Basis of bearings.
 Right of way plans for SR-166 (5500 East) were acquired from UDOT Region 1 for Project S-242(1). Sheet 3 shows the pertinent information to locate the right of way.
 A Right of way marker was found on the West side of 5500 East Street, and was used to aid in the positioning of the right of way in a East-west direction.
 Using the information shown on the plans files to existing structures were checked and found to be in tolerance. Angular information was also checked on the plan and was found to generally conform to the plan information, once the location for 5500 East Street was established.
 A strong metallic signal under asphalt paving was found on the East side of the right of way perpendicular to the found monument on the West side. The Property owner mentioned he remembered a monument at that location but that it had been paved over a few years ago.
 A right of way monument was also found at the Northwest corner of the intersection of 2200 North and 5500 East Streets, but it did not fit nor check with the established location of the right of way or occupation of 5500 East Street.
 The North line of the property was established from occupational evidence and by extending the North line of E.P. Subdivision.
 The East line of the property was established adjacent to the West line of line of E.P. Subdivision.
 The South line of the Property was established along the North line of 2200 North Street as shown on a record of survey drawing for Gale Armstrong, performed by Mountainwest Professional Land Surveyors dated 5/26/1992, filed September 22, 1992 as Survey #0764.

Found Right of Way Monument (Bent over Located 1/2 of Base)

Found Right of Way Monument (1.8' West)

State Highway 166 (5500 East Street)

E.P. Subdivision

GREAT BASIN ENGINEERING
 5746 SOUTH 1475 EAST OGDEN, UTAH 84403
 MAIN (801) 394-4515 S.L.C. (801) 521-0222 FAX (801) 392-7544
 WWW.GREATBASINENGINEERING.COM

Southeast corner of the Southwest Quarter of Section 35, T7N, R1E, SLB&M, (Found Weber County Brass Cap)

(2644.85' W.C.S.) 2644.80' Meas.

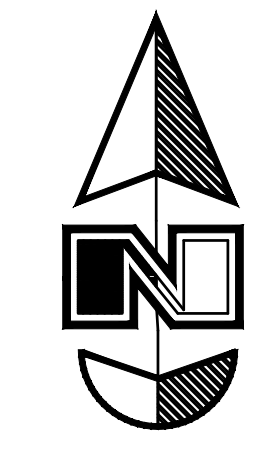

Scale: 1" = 20'

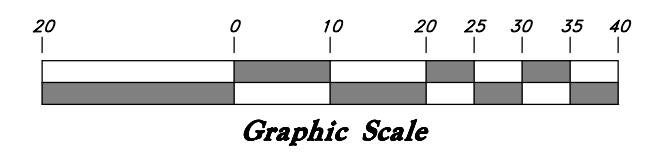

Legend

- ▲ Found Nail & Washer
- Rebar & Cap
- Set Hub & Tack
- ◆ Found Right of way Monument
- (Rad.) Radial Line
- (N/R) Non-Radial Line
- Fence
- W.C.S. Weber County Surveyor
- Meas. Measured Bearing or Distance
- Hwy State Highway Plan Information
- RT Rooftop
- FF Finished Floor
- EVE Building Eve

TENTATIVE FINAL

Old Town Eden Condominiums

An Expandable Utah Condominium Project
 A Part of Section 35, Township 7 North, Range 1 East, SLB&M
 Eden, Weber County, Utah

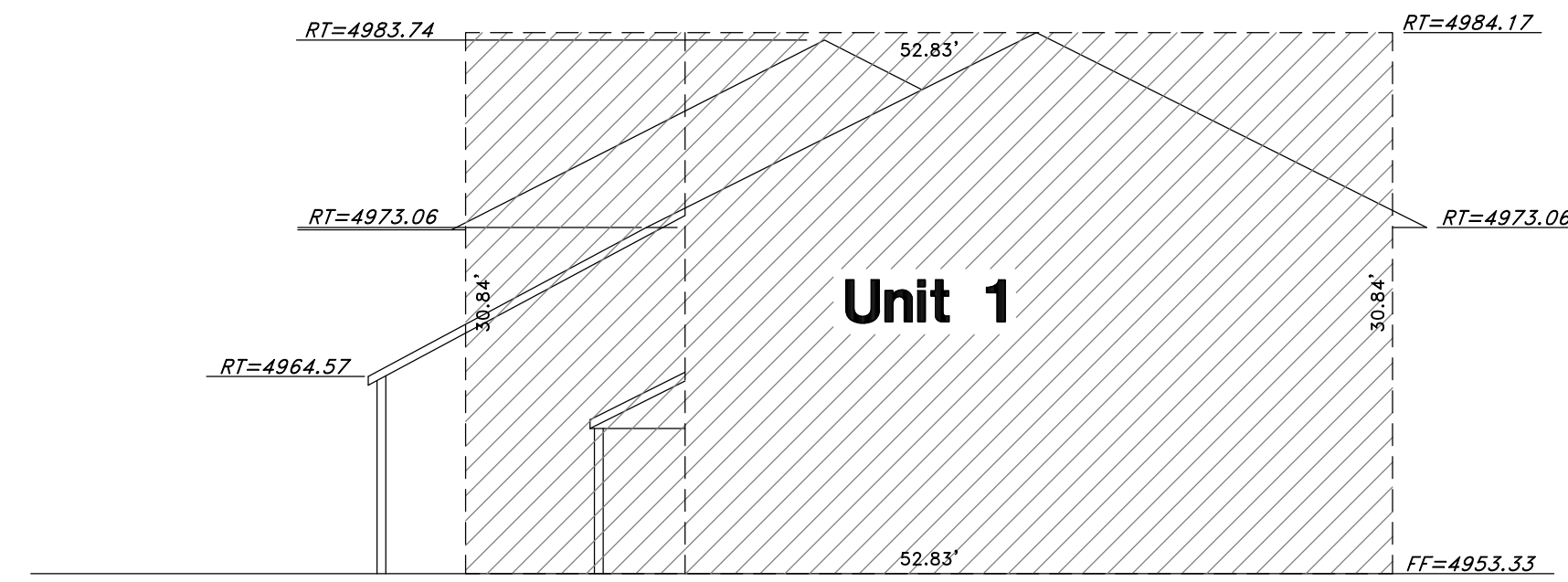
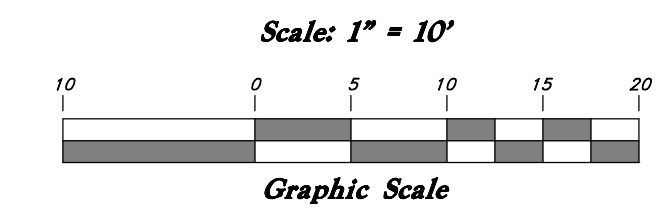
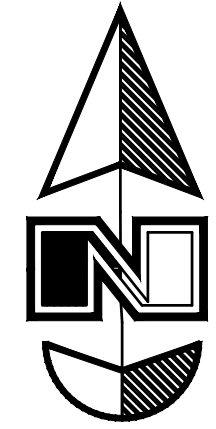

Section A-A

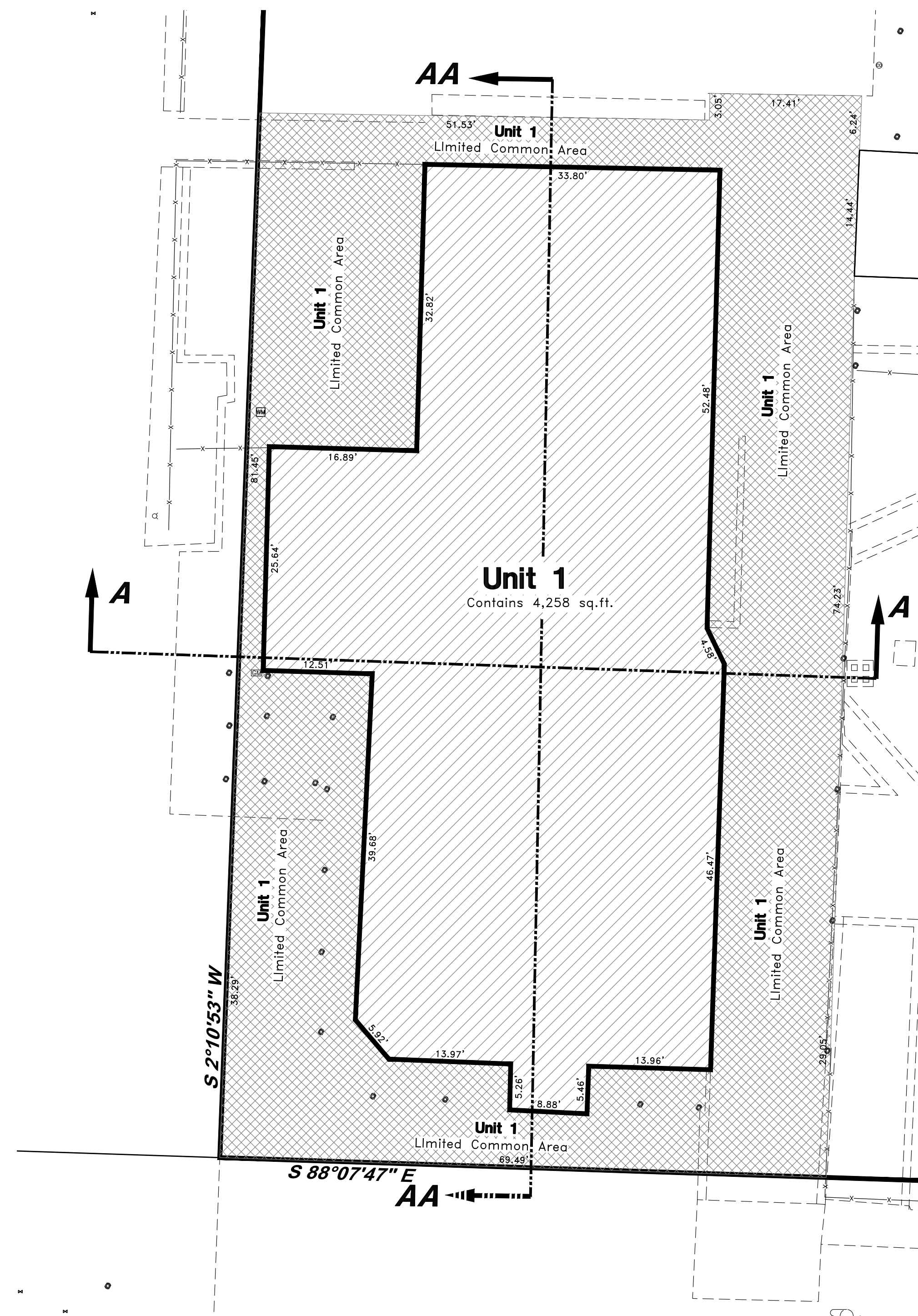

Unit 1

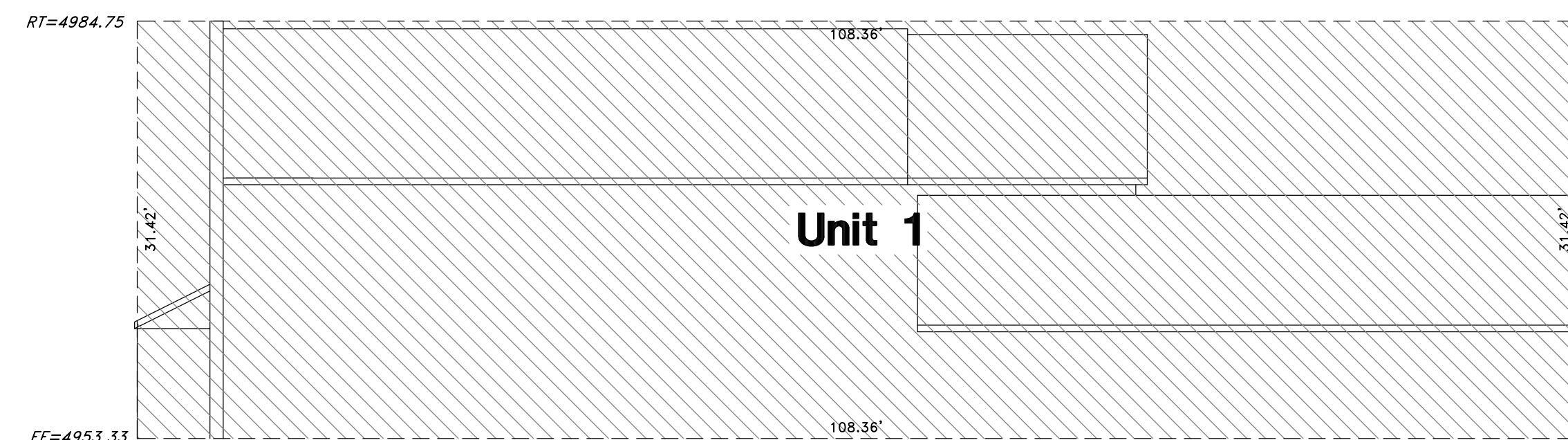

Section AA-AA

Legend

- ▲ Found Nail & Washer
- Rebar & Cap
- Set Hub & Tack
- ⊕ Found Right of way Monument
- (Rad.) Radial Line
- (N/R) Non-Radial Line
- - - Fence
- W.C.S. Weber County Surveyor
- Meas. Measured Bearing or Distance
- Hwy State Highway Plan Information
- RT Rooftop
- FF Finished Floor
- EVE Building Eve

NOTES:

1. Each condominium unit contained within the project is as shown and is designated by one of the following:
 Unit, consisting of 4 Units followed by a unit number (See Sheets 2 thru 4).
 General Common areas and facilities -
 Private ownership -
 Limited common areas and facilities -
2. All patios, decks, or balconies, contained within the project are, considered Limited Common Areas. They are set aside and reserved for the use of the respective condominium unit to which they are attached and/or appurtenant.
3. All other areas contained within the project, but not shown with diagonal stripe or cross hatched lines are considered Common Area, including sanitary sewer drain field area.
4. Dimensions on Sheet 1 are to exterior foundation only.
5. All Common Area is considered to be an easement for public utility and drainage purposes.

Sheet 2 of 5

GREAT BASIN ENGINEERING
 5746 SOUTH 1475 EAST OGDEN, UTAH 84403
 MAIN (801)394-4515 S.L.C (801)521-0222 FAX (801)392-7544
 WWW.GREATBASINENGINEERING.COM

TENTATIVE FINAL

WEBER COUNTY RECORDER
 ENTRY NO. _____ FEE PAID _____
 RECORDED _____ FILED FOR RECORD AND _____ AT _____
 IN BOOK _____ OF OFFICIAL RECORDS, PAGE _____ RECORDED FOR _____
 WEBER COUNTY RECORDER
 BY: _____ DEPUTY _____

Old Town Eden Condominiums

An Expandable Utah Condominium Project
 A Part of Section 35, Township 7 North, Range 1 East, SLB&M
 Eden, Weber County, Utah

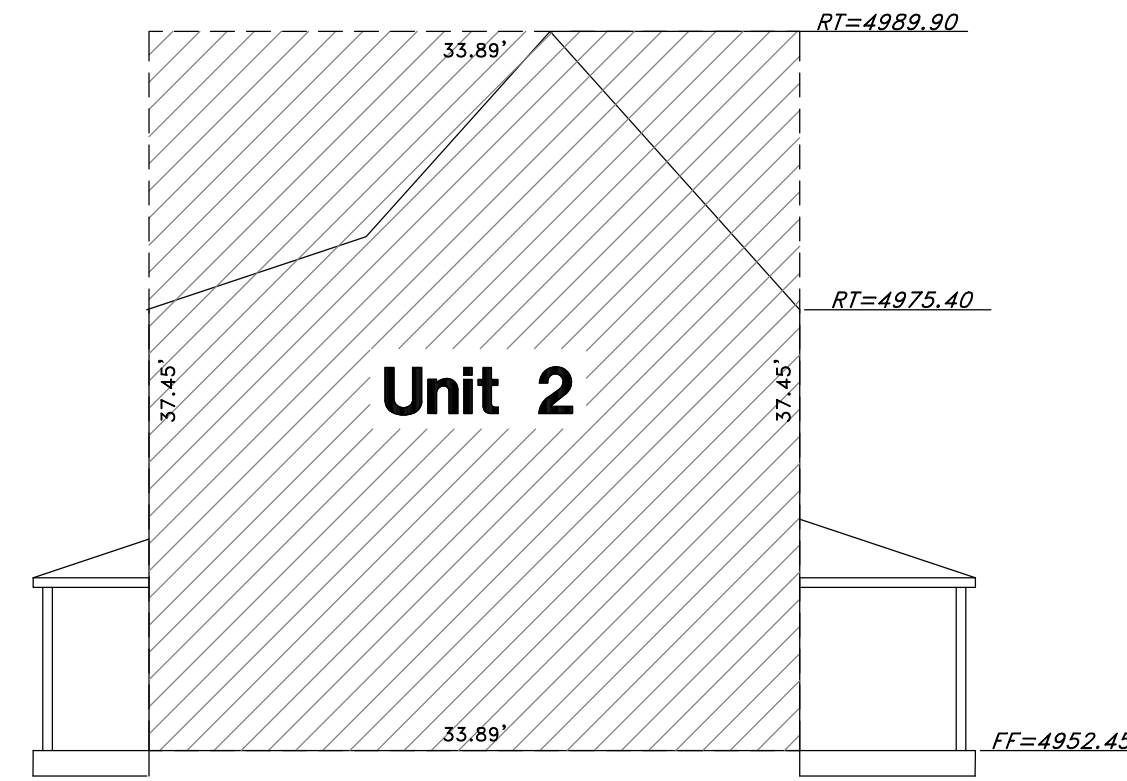
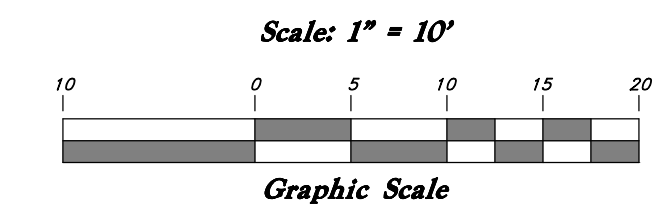
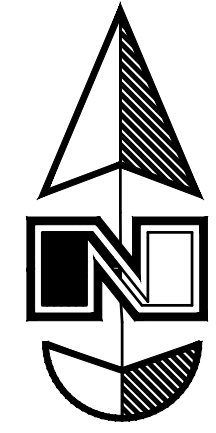

Section B-B

Legend

- ▲ Found Nail & Washer
- Rebar & Cap
- Set Hub & Tack
- ⊕ Found Right of way Monument
- (Rad.) Radial Line
- (N/R) Non-Radial Line
- Fence
- W.C.S. Weber County Surveyor
- Meas. Measured Bearing or Distance
- Hwy State Highway Plan Information
- RT Rooflop
- FF Finished Floor
- EVE Building Eve

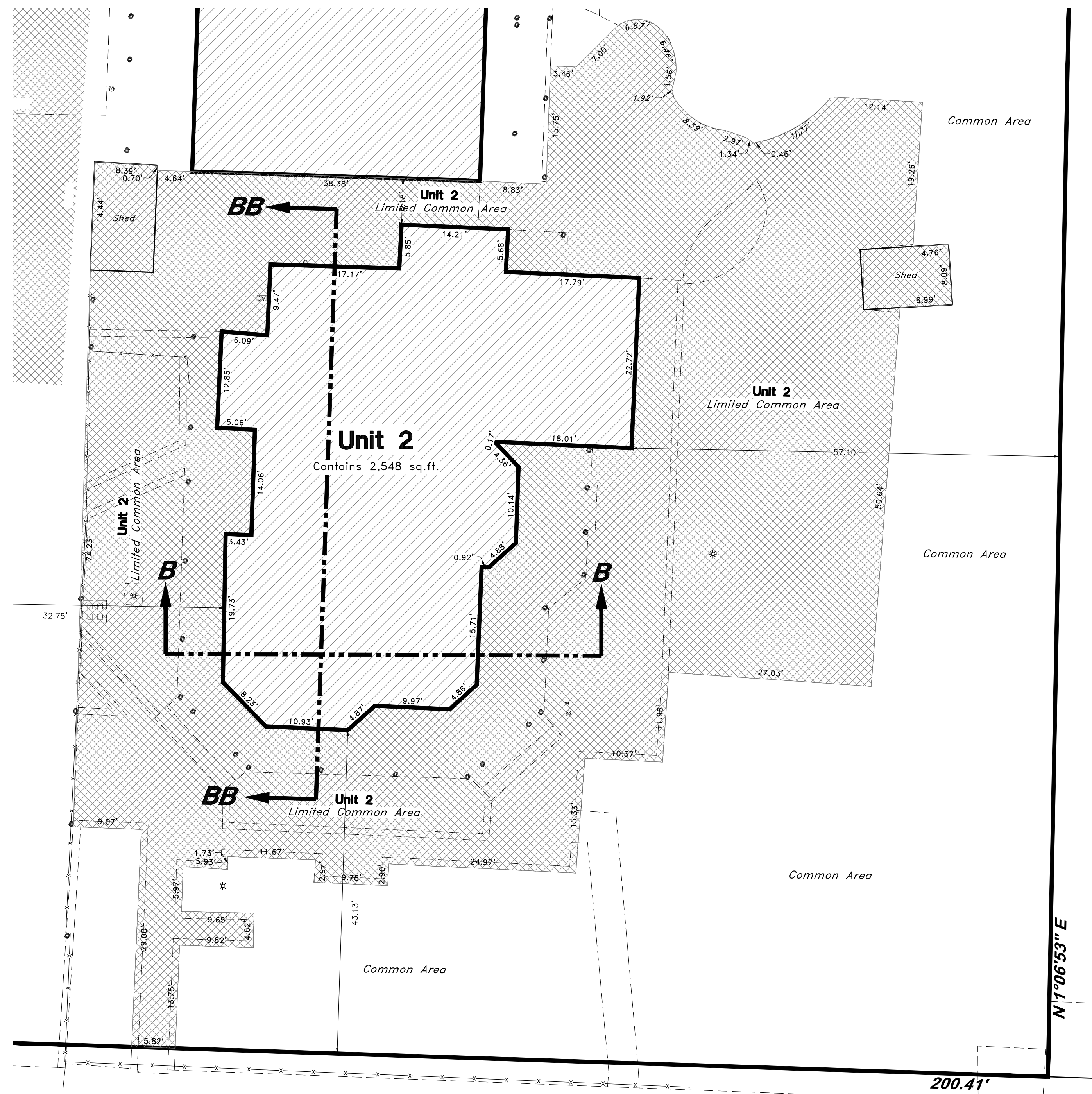

Unit 2

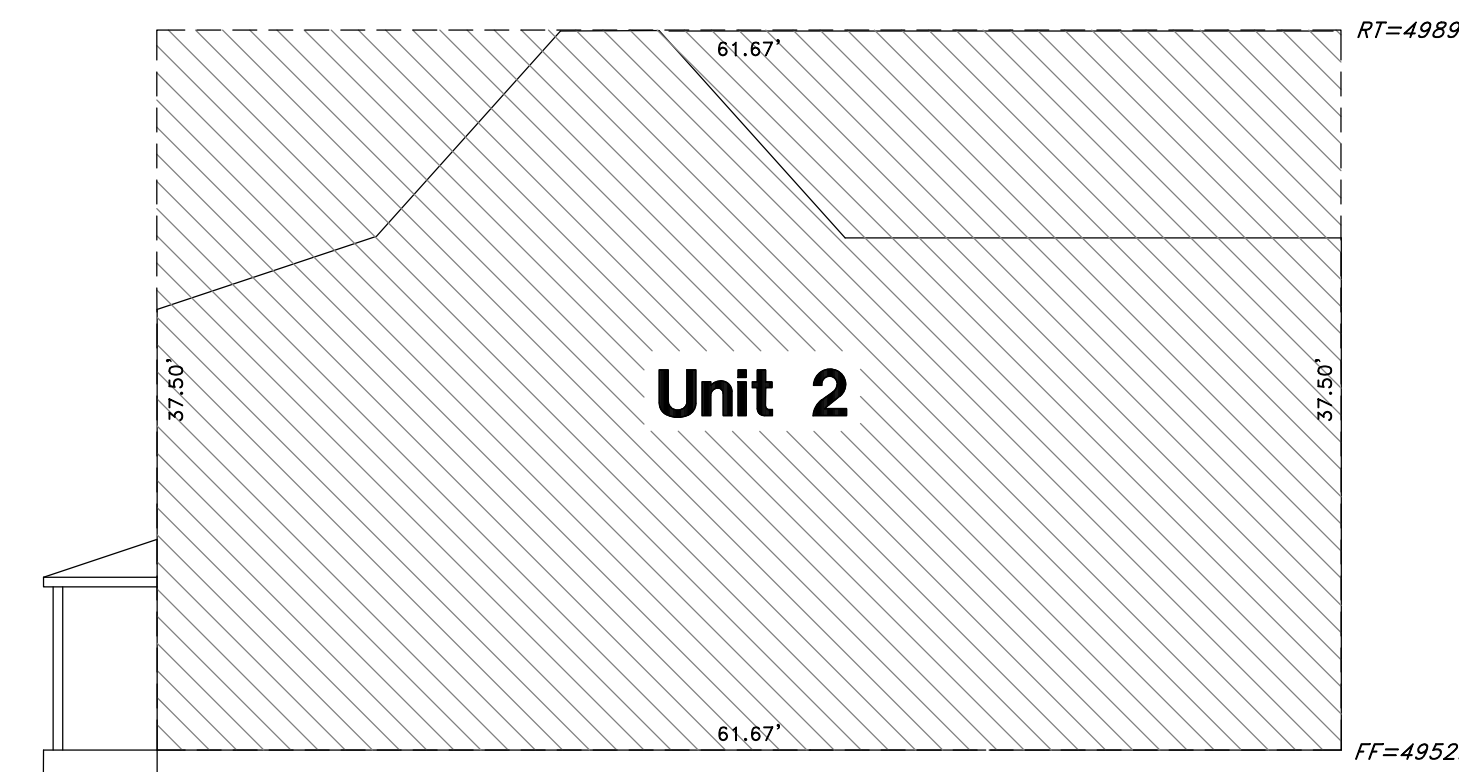

Section BB-BB

NOTES:

1. Each condominium unit contained within the project is as shown and is designated by one of the following:
 Unit, consisting of 4 Units followed by a unit number (See Sheets 2 thru 4).
 General Common areas and facilities -
 Private ownership -
 Limited common areas and facilities -
2. All patios, decks, or balconies, contained within the project are considered Limited Common Areas. They are set aside and reserved for the use of the respective condominium unit to which they are attached and/or appurtenant.
3. All other areas contained within the project, but not shown with diagonal stripe or cross hatched lines are considered Common Area, including sanitary sewer drain field area.
4. Dimensions on Sheet 1 are to exterior foundation only.
5. All Common Area is considered to be an easement for public utility and drainage purposes.

GREAT BASIN ENGINEERING
 5746 SOUTH 1475 EAST OGDEN, UTAH 84403
 MAIN (801)394-4515 S.L.C (801)521-0222 FAX (801)392-7544
 WWW.GREATBASINENGINEERING.COM

TENTATIVE FINAL

WEBER COUNTY RECORDER
 ENTRY NO. _____ FEE PAID _____
 RECORDED _____ FILED FOR RECORD AND
 _____ AT _____
 _____ IN BOOK _____ OF OFFICIAL
 RECORDS, PAGE _____ RECORDED
 FOR _____
 WEBER COUNTY RECORDER
 BY: _____ DEPUTY _____

Old Town Eden Condominiums

An Expandable Utah Condominium Project
 A Part of Section 35, Township 7 North, Range 1 East, SLB&M
 Eden, Weber County, Utah

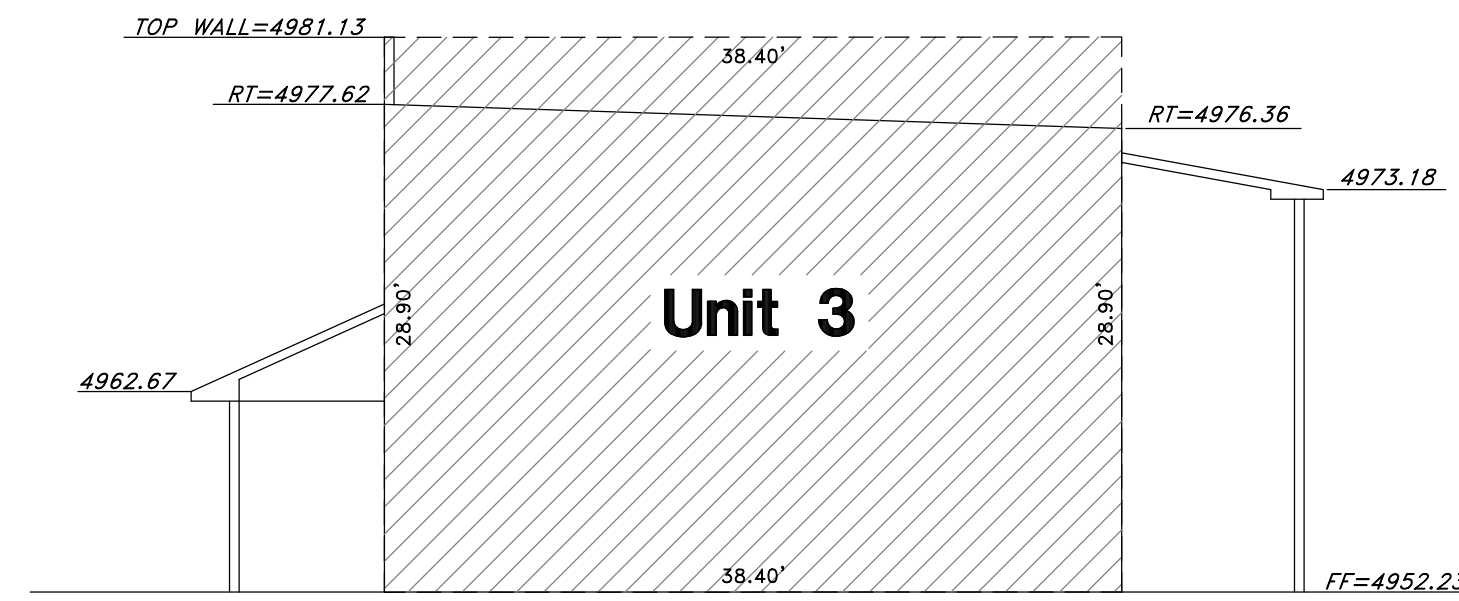
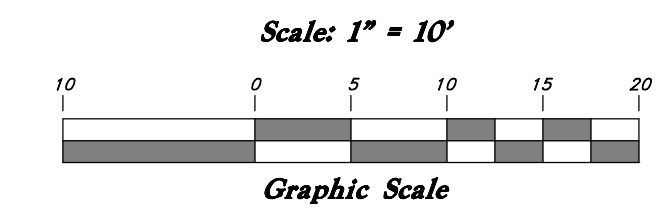
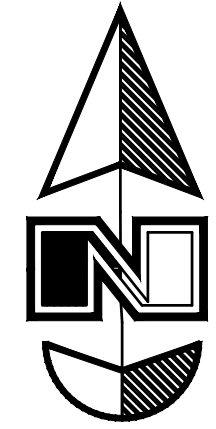

Section C-C

Legend

- ▲ Found Nail & Washer
- Rebar & Cap
- Set Hub & Tack
- ⊕ Found Right of way Monument
- (Rad.) Radial Line
- (N/R) Non-Radial Line
- Fence
- W.C.S. Weber County Surveyor
- Meas. Measured Bearing or Distance
- Hwy State Highway Plan Information
- RT Rooftop
- FF Finished Floor
- EVE Building Eve

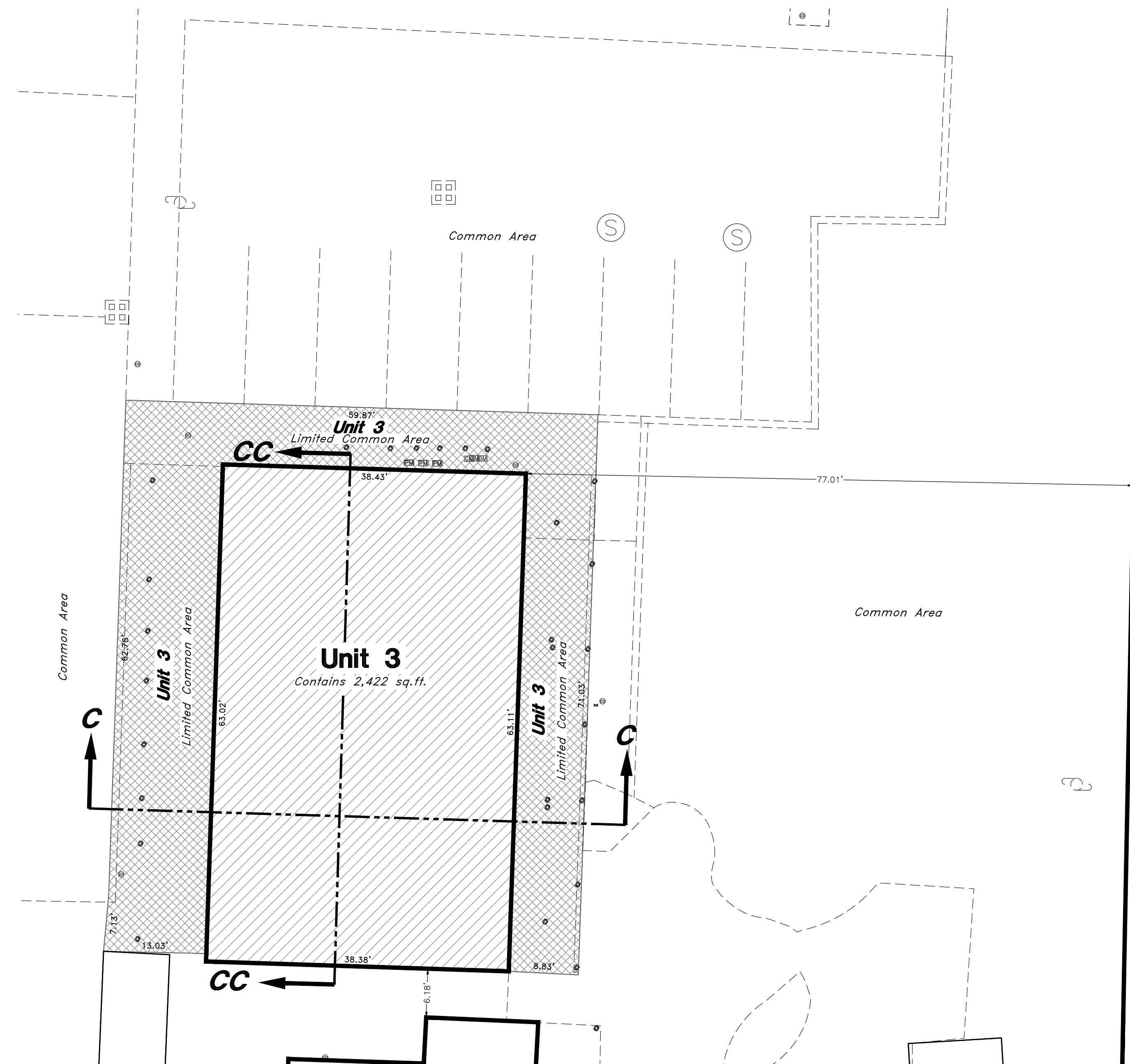

Unit 3

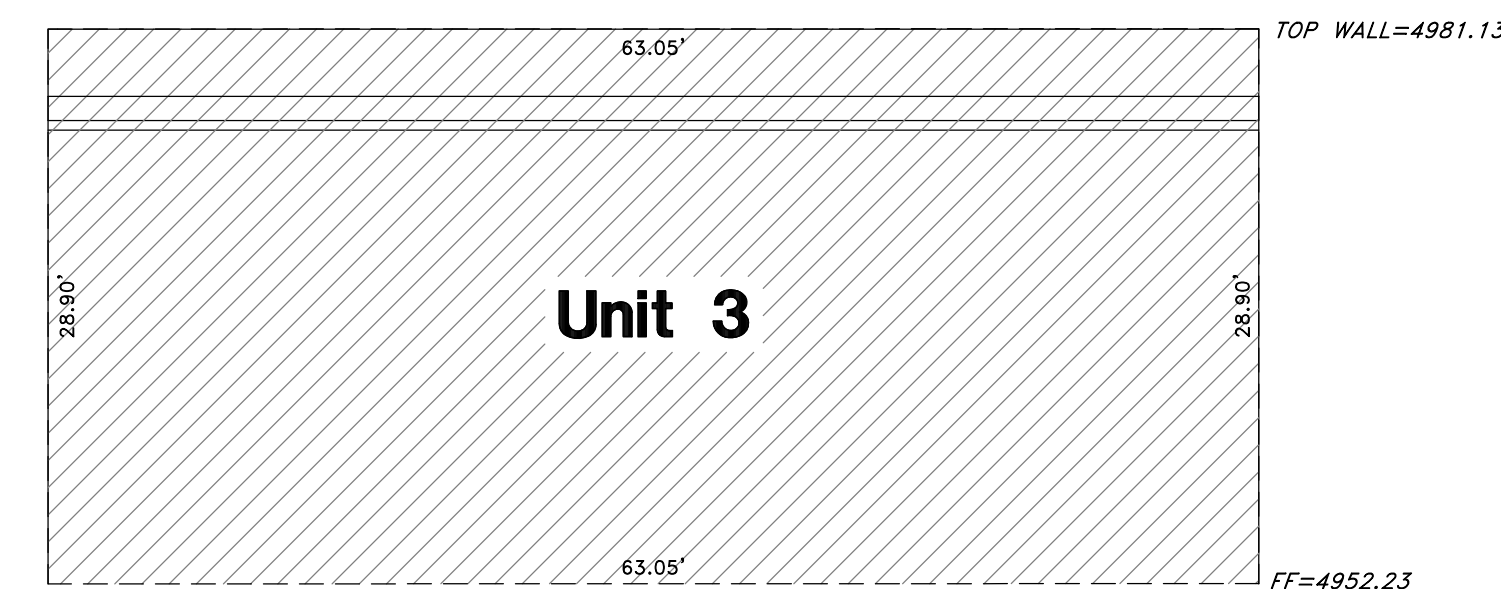

Section CC-CC

NOTES:

1. Each condominium unit contained within the project is as shown and is designated by one of the following:
 Unit, consisting of 4 Units followed by a unit number (See Sheets 2 thru 4).
 General Common areas and facilities -
 Private ownership -
 Limited common areas and facilities -
2. All patios, decks, or balconies, contained within the project are considered Limited Common Areas. They are set aside and reserved for the use of the respective condominium unit to which they are attached and/or appurtenant.
3. All other areas contained within the project, but not shown with diagonal stripe or cross hatched lines are considered Common Area, including sanitary sewer drain field area.
4. Dimensions on Sheet 1 are to exterior foundation only.
5. All Common Area is considered to be an easement for public utility and drainage purposes.



5746 SOUTH 1475 EAST OGDEN, UTAH 84403
 MAIN (801)394-4515 S.L.C (801)521-0222 FAX (801)392-7544
 WWW.GREATBASINENGINEERING.COM

TENTATIVE FINAL

Sheet 4 of 5

WEBER COUNTY RECORDER
 ENTRY NO. _____ FEE PAID _____
 RECORDED _____ FILED FOR RECORD AND
 _____ AT _____
 _____ IN BOOK _____ OF OFFICIAL
 RECORDS, PAGE _____ RECORDED
 FOR _____
 WEBER COUNTY RECORDER
 BY: _____ DEPUTY _____

Old Town Eden Condominiums

An Expandable Utah Condominium Project
 A Part of Section 35, Township 7 North, Range 1 East, SLB&M
 Eden, Weber County, Utah

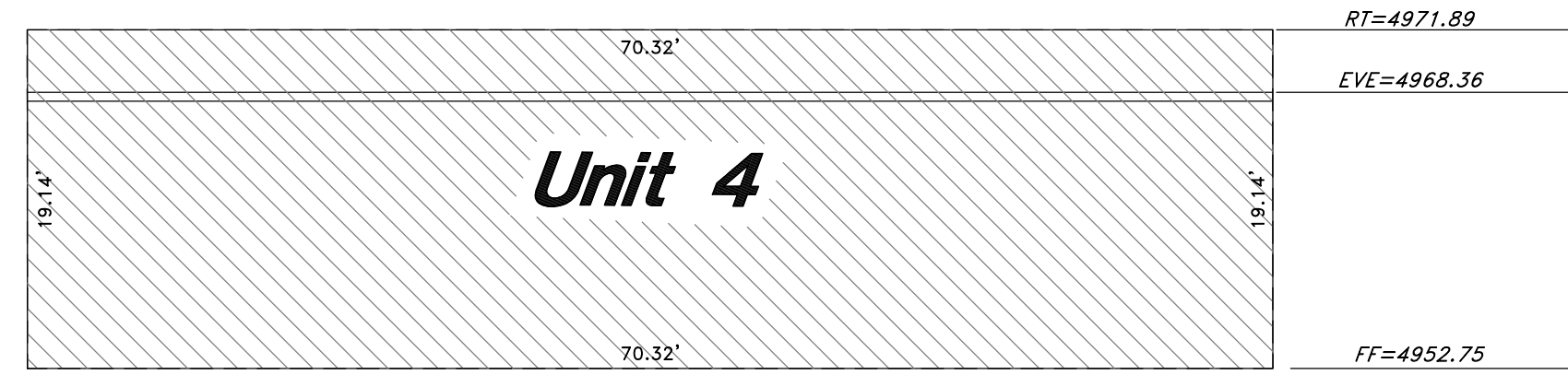
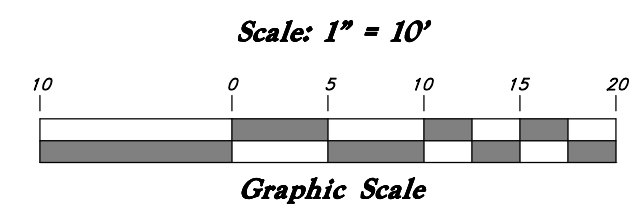
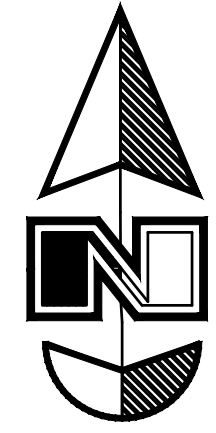

Unit 4

Section C-C

Legend

- ▲ Found Nail & Washer
- Rebar & Cap
- Set Hub & Tack
- ⊕ Found Right of way Monument
- (Rad.) Radial Line
- (N/R) Non-Radial Line
- - - Fence
- W.C.S. Weber County Surveyor
- Meas. Measured Bearing or Distance
- Hwy State Highway Plan Information
- RT Rooftop
- FF Finished Floor
- EVE Building Eve

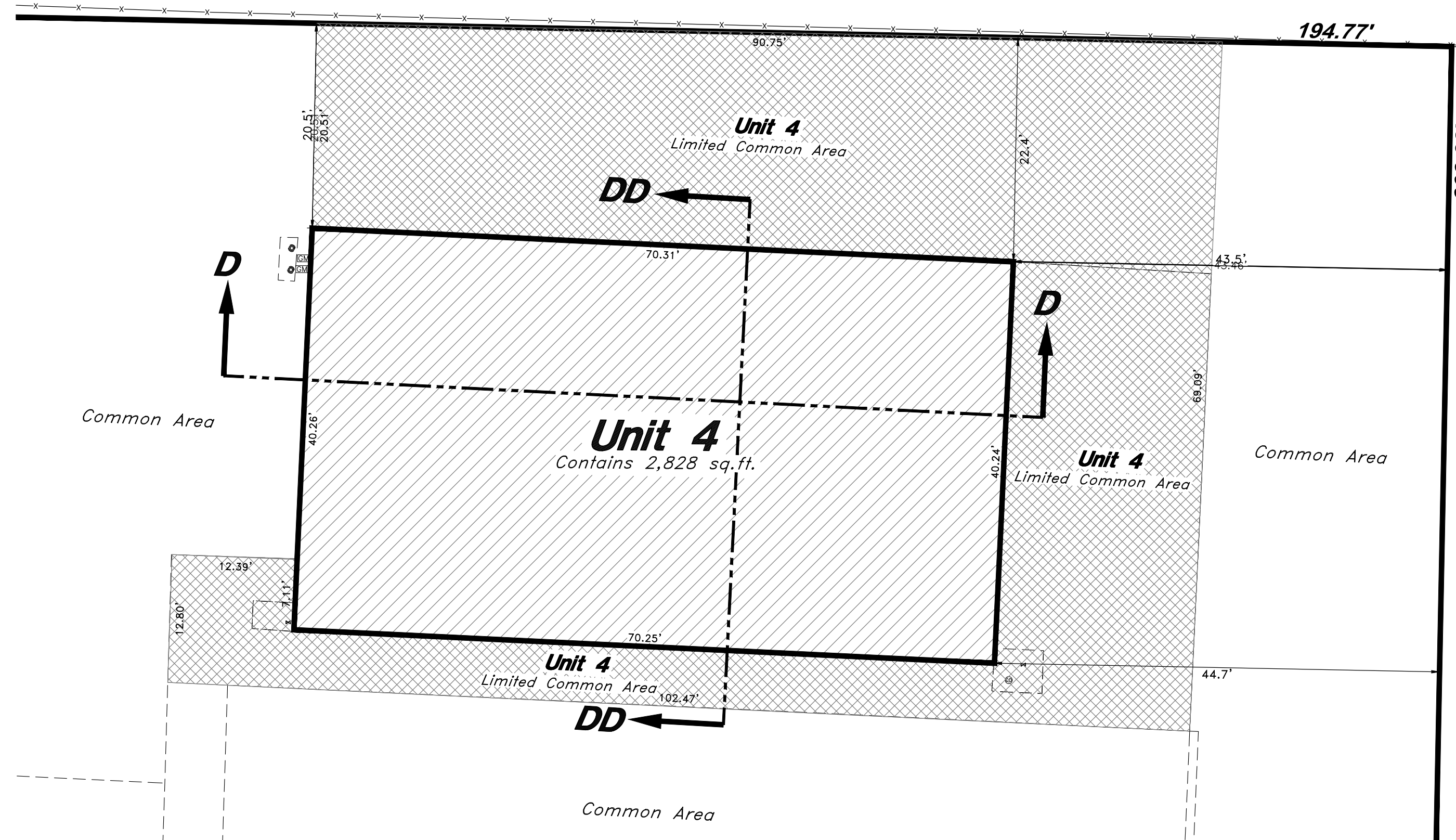

Unit 4

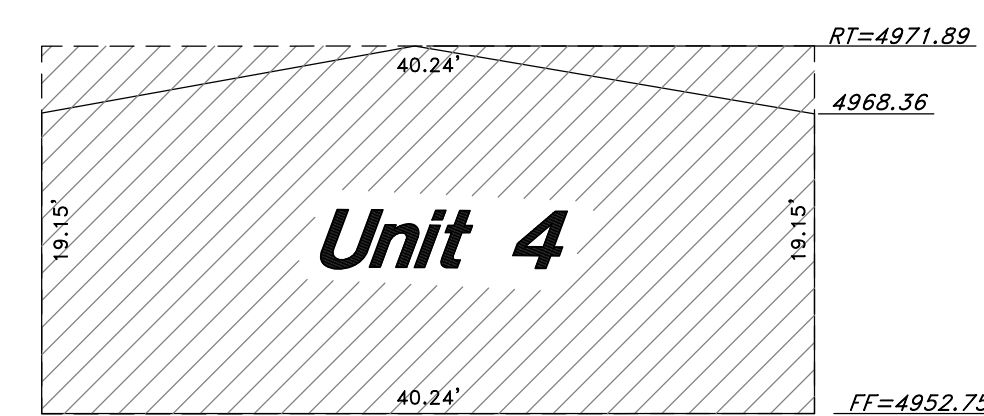

Section DD-DD

NOTES:

1. Each condominium unit contained within the project is as shown and is designated by one of the following:
 Unit, consisting of 4 Units followed by a unit number (See Sheets 2 thru 4).
 General Common areas and facilities -
 Private ownership -
 Limited common areas and facilities -
2. All patios, decks, or balconies, contained within the project are considered Limited Common Areas. They are set aside and reserved for the use of the respective condominium unit to which they are attached and/or appurtenant.
3. All other areas contained within the project, but not shown with diagonal stripe or cross hatched lines are considered Common Area, including sanitary sewer drain field area.
4. Dimensions on Sheet 1 are to exterior foundation only.
5. All Common Area is considered to be an easement for public utility and drainage purposes.

GREAT BASIN ENGINEERING
 5746 SOUTH 1475 EAST OGDEN, UTAH 84403
 MAIN (801)394-4515 S.L.C (801)521-0222 FAX (801)392-7544
 WWW.GREATBASINENGINEERING.COM

Sheet 5 of 5

WEBER COUNTY RECORDER

ENTRY NO. _____ FEE PAID _____

RECORDED _____ AT _____

IN BOOK _____ OF OFFICIAL RECORDS, PAGE _____ RECORDED FOR _____

WEBER COUNTY RECORDER

BY: _____ DEPUTY

TENTATIVE FINAL