

# Storm Water Pollution Prevention Plan

## for:

Sandhill Crane Cluster Subdivision  
2500 North Street  
Eden, UT

## Operator(s):

E.K. Bailey Construction  
1243 N. Washington Blvd.  
Ogden, UT 84414  
801-782-4748  
Mike.grow@ekbailey.com

## SWPPP Contact(s):

E.K. Bailey Construction  
Mike Grow  
1243 N. Washington Blvd.  
Ogden, UT 8414  
801-782-4748  
Mike.grow@ekbailey.com

## SWPPP Preparation Date:

*Estimated Project Dates:*

**Project Start Date: June 2016**  
**Project Completion Date: October 2016**

---

## Contents

---

<b>SECTION 1: CONTACT INFORMATION/ RESPONSIBLE PARTIES .....</b>	<b>1</b>
1.1 Owner(s), Operator, Contractors .....	1
1.2 Storm Water Team .....	2
<b>SECTION 2: SITE EVALUATION, ASSESSMENT, &amp; PLANNING .....</b>	<b>3</b>
2.1 Project/Site Information .....	3
2.2 Nature of Construction Activity .....	3
2.3 Construction Site Estimates .....	4
2.4 Soils, Slopes, Vegetation, and Current Drainage Patterns .....	4
2.5 Emergency Related Projects .....	5
2.6 Phase/Sequence of Construction Activity .....	5
2.7 Site Features and Sensitive Areas to be Protected .....	5
2.8 Maps .....	5
<b>SECTION 3: POLLUTION PREVENTION STANDARDS .....</b>	<b>6</b>
3.1 Potential Sources of Pollution .....	6
3.2 Non-Storm Water Discharges .....	7
3.3 Natural Buffers or Equivalent Sediment Controls .....	7
<b>SECTION 4: EROSION AND SEDIMENT CONTROLS .....</b>	<b>11</b>
4.1 Minimize Disturbed Area and Protect Natural Features and Soil .....	11
4.2 Establish Perimeter Controls and Sediment Barriers .....	11
4.3 Retain Sediment On-Site .....	11
4.4 Establish Stabilized Construction Exits .....	12
4.5 Protect Slopes .....	12
4.6 Stockpiled Sediment or Soil .....	13
4.7 Minimize Dust .....	13
4.8 Topsoil .....	13
4.9 Soil Compaction .....	14
4.10 High Altitude/Heavy Snows .....	14
4.11 Linear Activities .....	15
4.12 Chemical Treatment .....	15
4.13 Stabilize Soils .....	16
4.14 Final Stabilization .....	16
<b>SECTION 5: POLLUTION PREVENTION .....</b>	<b>17</b>
5.1 Spill Prevention and Response .....	17
5.2 Construction and Domestic Waste .....	17
5.3 Washing of Applicators and Containers used for Concrete, Paint or Other Materials .....	18
5.4 Establish Proper Building Material Staging Areas .....	18
5.5 Establish Proper Equipment/Vehicle Fueling and Maintenance Practices .....	19
5.6 Control Equipment/Vehicle Washing .....	19
5.7 Pesticides, Herbicides, Insecticides, Fertilizers, and Landscape Materials .....	20
5.8 Other Pollution Prevention Practices .....	20
<b>SECTION 6: INSPECTIONS &amp; CORRECTIVE ACTIONS .....</b>	<b>21</b>
6.1 Inspections .....	21
Reduction in Inspection Frequency (if applicable) .....	21

---

6.2	Corrective Actions .....	21
6.3	Delegation of Authority .....	22
<b>SECTION 7: TRAINING AND RECORDKEEPING .....</b>		<b>23</b>
7.1	Training .....	23
7.2	Recordkeeping .....	23
7.3	Log of Changes to the SWPPP .....	24
<b>SECTION 8: WATER QUALITY .....</b>		<b>25</b>
8.1	UIC Class 5 Injection Wells .....	
8.2	Discharge Information .....	25
8.3	Receiving Waters .....	25
8.4	Impaired Waters .....	25
8.5	High Water Quality .....	26
8.6	Dewatering Practices .....	26
8.7	Control Storm Water Flowing onto and through the Project .....	26
8.8	Protect Storm Drain Inlets .....	27
<b>SECTION 9: POST-CONSTRUCTION BMPs .....</b>		<b>28</b>
<b>SECTION 10: CERTIFICATION.....</b>		<b>28</b>
<b>SWPPP APPENDICES .....</b>		<b>29</b>
Appendix A – General Location Map .....		29
Appendix B – Site Maps .....		29
Appendix C – Construction General Permit .....		29
Appendix D – NOI and Acknowledgement Letter from EPA/State/MS4.....		29
Appendix E – Inspection Reports.....		29
Appendix F – Corrective Action Log (or in Part 5.3).....		29
Appendix G – SWPPP Amendment Log (or in Part 7.4) .....		29
Appendix H – Subcontractor Certifications/Agreements .....		29
Appendix I – Grading and Stabilization Activities Log.....		29
Appendix J – Training Log .....		29
Appendix K – Delegation of Authority .....		29
Appendix L – Additional Information (i.e. Documentation; other permits such as dewatering, stream alteration, wetland; and out of date swppp documents).....		29
Appendix M – BMP Specifications.....		29

## **SECTION 1: CONTACT INFORMATION/ RESPONSIBLE PARTIES**

### **1.1 Owner(s), Operator, Contractors**

**Owner(s):**

Blake Wahlen  
2080 East Oakridge Circle  
Layton, UT 84040  
801-510-6136

JW Valley Investments  
Steve Waldrip  
2844 N 4975 E  
Eden, UT 84310  
801-540-2349

**Operator & Project Manager:**

E.K. Bailey Construction  
Mike Grow  
1243 N. Washington Blvd  
Ogden, UT 84414  
801-782-4748:  
Mike.grow@ekbailey.com

**Site Supervisor(s):**

E.K. Bailey Construction  
Mike Grow  
1243 N. Washington Blvd.  
Ogden, UT 84414  
801-698-7986

**SWPPP Contact(s):**

E.K. Bailey Construction  
Mike Grow  
1243 N. Washington Blvd:  
Ogden, UT 84414:  
801-782-4748:  
Mike.grow@ekbailey.com



**This SWPPP was Prepared by:**

E.K. Bailey Construction:  
Kraig Urry  
1243 N. Washington Blvd.  
Ogden, UT 84414  
801-782-4748:  
Kraig.urry@ekbailey.com

**Emergency 24-Hour Contact:**

E.K Bailey Construction:  
Mike Grow  
801-698-7986

**1.2 Storm Water Team**

Overall Site supervision:  
Superintendent  
Steve Edstrom  
951-533-3242

Excavation & Demolition Management:  
Field Operations Supervisor  
Mike Grow  
801-698-7986  
Mike.grow@ekbailey.com

SWPPP Inspections  
Safety Manager/SWPPP Inspector  
Mark Horton  
801-430-5765  
Mark.horton@ekbailey.com

## SECTION 2: SITE EVALUATION, ASSESSMENT, & PLANNING

### 2.1 Project/Site Information

Project/Site Name: Sandhill Crane Cluster Subdivision

Project Street/Location: 2500 North Street

City: Eden State: UT ZIP Code: 84310

County or Similar Subdivision: Weber

Latitude/Longitude (Use **one** of three possible formats, and specify method)

Latitude:

1. 40 ° 18 ' 12" N (degrees, minutes, seconds)

2. \_\_ ° \_\_ ' \_\_" N (degrees, minutes, decimal)

3. \_\_ . \_\_\_\_\_ ° N (decimal)

Longitude:

1. 111 ° 48 ' 33" W (degrees, minutes, seconds)

2. \_\_ ° \_\_ ' \_\_" W (degrees, minutes, decimal)

3. \_\_ . \_\_\_\_\_ ° W (decimal)

Method for determining latitude/longitude: Google Earth

USGS topographic map (specify scale: \_\_\_\_\_)  EPA Web site  GPS

Other (please specify): Google Earth

Is the project located in Indian country?  Yes  No

If yes, name of Reservation, or if not part of a Reservation, indicate "not applicable." \_\_\_\_\_

Is this project considered a federal facility?  Yes  No

UPDES project or permit tracking number\*: \_\_\_\_\_

*\*(This is the unique identifying number assigned to your project by your permitting authority after you have applied for coverage under the appropriate National Pollutant Discharge Elimination System (UPDES) construction general permit.)*

### 2.2 Nature of Construction Activity

Describe the general scope of the work for the project, major phases of construction, etc:

Construction of 480 feet of new road with a cul-de-sac.

What is the function of the construction activity?

Residential  Commercial  Industrial  Road Construction  Linear Utility

Other (please specify):

Estimated Project Start Date: June 1, 2016  
Estimated Project Completion Date: October 1, 2016

### **2.3 Construction Site Estimates**

The following are estimates of the construction site.

Total project area:	18 acres
Construction site area to be disturbed:	3 acres
Percentage impervious area before construction:	
Runoff coefficient before construction:	
Percentage impervious area after construction:	
Runoff coefficient after construction	

### **2.4 Soils, Slopes, Vegetation, and Current Drainage Patterns**

Soil type(s): The geotechnical study identifies the near-surface soils as clayey and or silty soils.

Slopes (describe current slopes and note any changes due to grading or fill activities):

The site slopes to the South East corner where a detention basin will be constructed.

Drainage Patterns (describe current drainage patterns and note any changes dues to grading or fill activities):

After cut and fill operations the overall drainage will remain similar to the existing.

Vegetation: Currently the site is a hay field.

Other:

## **2.5 Emergency Related Projects**

Emergency-Related Project?       Yes       No

## **2.6 Phase/Sequence of Construction Activity**

### Phase I

- Clearing & Grubbing
- June 2016
- Inlet protection at all existing storm drain boxes, silt fence as needed, seeding, controlled staging area, concrete washout, surface roughening, vehicle tracking control,
- Seeding, Landscaping, Asphalt and concrete hardscape.

### Phase II

- Installation of utilities and construction of roadway
- July 2016
- List BMPs associated with this phase
- Inlet protection, silt fence, surface roughening, seeding, controlled staging area, tracking control,
- Describe stabilization methods for this phase  
Seeding, Landscaping, Asphalt and concrete hardscape.

## **2.7 Site Features and Sensitive Areas to be Protected**

## **2.8 Maps**

See Appendix A

## SECTION 3: POLLUTION PREVENTION STANDARDS

### 3.1 Potential Sources of Pollution

Potential sources of sediment to storm water runoff:

Excavation piles, stock piles

Potential pollutants and sources, other than sediment, to storm water runoff:

Motor Oil, Hydraulic Fluid, Antifreeze, Grease, Diesel Fuel, Gasoline.

<b>Pollutant-Generating Activity</b>	<b>Pollutants or Pollutant Constituents</b> (that could be discharged if exposed to storm water)	<b>Location on Site</b> (or reference SWPPP site map where this is shown)
Clearing & Grubbing	Silt	Entire Site
Excavation	Oils and Fuel	Entire Site
Concrete	Concrete wash out	Wash out area
Debris Disposal	Trash & Debris	Trash Dumpster locations
Material Delivery & Storage	Nutrients, Trash, Oils, Fuels etc.	Material staging areas
Vehicle/equipment fueling, use and maintenance	Fuels & Oils	Vehicle fueling area

### 3.2 Non-Storm Water Discharges

List allowable non-storm water discharges and the measures used to eliminate or reduce them and to prevent them from becoming contaminated:

Authorized Non-Storm Water Discharges	Comments
Water to control dust	
Landscape irrigation	

Include additional rows as necessary.

<b><i>BMP Description: Employee Training</i></b>	
<b><i>Installation Schedule:</i></b>	As needed
<b><i>Maintenance and Inspection:</i></b>	
<b><i>Responsible Staff:</i></b>	SWPPP Inspector – Mark Horton

<b><i>BMP Description:</i></b>	
<b><i>Installation Schedule:</i></b>	
<b><i>Maintenance and Inspection:</i></b>	
<b><i>Responsible Staff:</i></b>	

Repeat as needed

### 3.3 Natural Buffers or Equivalent Sediment Controls

**Buffer Compliance Alternatives**

Are there any surface waters within 50 feet of your project’s earth disturbances?  YES  NO

(Note: If no, no further documentation is required for the SWPPP Template.)

Check the compliance alternative that you have chosen:

- I will provide and maintain a 50-foot undisturbed natural buffer.

*(Note (1): You must show the 50-foot boundary line of the natural buffer on your site map.)*

*(Note (2): You must show on your site map how all discharges from your construction disturbances through the natural buffer area will first be treated by the site's erosion and sediment controls. Also, show on the site map any velocity dissipation devices used to prevent erosion within the natural buffer area.)*

- I will provide and maintain an undisturbed natural buffer that is less than 50 feet and is supplemented by additional erosion and sediment controls, which in combination achieves the sediment load reduction equivalent to a 50-foot undisturbed natural buffer.

*(Note (1): You must show the boundary line of the natural buffer on your site map.)*

*(Note (2): You must show on your site map how all discharges from your construction disturbances through the natural buffer area will first be treated by the site's erosion and sediment controls. Also, show on the site map any velocity dissipation devices used to prevent erosion within the natural buffer area.)*

- INSERT WIDTH OF NATURAL BUFFER TO BE RETAINED
- INSERT EITHER ONE OF THE FOLLOWING:
  - (1) THE ESTIMATED SEDIMENT REMOVAL FROM A 50-FOOT BUFFER USING APPLICABLE INFORMATION IN APP. D, 2.2.2. INCLUDE INFORMATION ABOUT THE BUFFER VEGETATION AND SOIL TYPE THAT PREDOMINATE AT YOUR SITE
- OR
- (2) IF YOU CONDUCTED A SITE-SPECIFIC CALCULATION FOR THE ESTIMATED SEDIMENT REMOVAL OF A 50-FOOT BUFFER, PROVIDE THE SPECIFIC REMOVAL EFFICIENCY, AND INFORMATION YOU RELIED UPON TO MAKE YOUR SITE-SPECIFIC CALCULATION.
- INSERT DESCRIPTION OF ADDITIONAL EROSION AND SEDIMENT CONTROLS TO BE USED IN COMBINATION WITH NATURAL BUFFER AREA
- INSERT THE FOLLOWING INFORMATION:
  - (1) SPECIFY THE MODEL OR OTHER TOOL USED TO ESTIMATE SEDIMENT LOAD REDUCTIONS FROM THE COMBINATION OF THE BUFFER AREA AND ADDITIONAL EROSION AND SEDIMENT CONTROLS INSTALLED AT YOUR SITE, AND
  - (2) INCLUDE THE RESULTS OF CALCULATIONS SHOWING THAT THE COMBINATION OF YOUR BUFFER AREA AND THE ADDITIONAL EROSION AND SEDIMENT CONTROLS INSTALLED AT YOUR SITE WILL MEET OR EXCEED THE SEDIMENT REMOVAL EFFICIENCY OF A 50-FOOT BUFFER

- It is infeasible to provide and maintain an undisturbed natural buffer of any size, therefore I will implement erosion and sediment controls that achieve the sediment load reduction equivalent to a 50-foot undisturbed natural buffer.

- INSERT RATIONALE FOR CONCLUDING THAT IT IS INFEASIBLE TO PROVIDE AND MAINTAIN A NATURAL BUFFER OF ANY SIZE
- INSERT EITHER ONE OF THE FOLLOWING:
  - OR

(2) IF YOU CONDUCTED A SITE-SPECIFIC CALCULATION FOR THE ESTIMATED SEDIMENT REMOVAL OF A 50-FOOT BUFFER, PROVIDE THE SPECIFIC REMOVAL EFFICIENCY, AND INFORMATION YOU RELIED UPON TO MAKE YOUR SITE-SPECIFIC CALCULATION.

- INSERT DESCRIPTION OF ADDITIONAL EROSION AND SEDIMENT CONTROLS TO BE USED IN COMBINATION WITH NATURAL BUFFER AREA
- INSERT THE FOLLOWING INFORMATION:
  - (1) SPECIFY THE MODEL OR OTHER TOOL USED TO ESTIMATE SEDIMENT LOAD REDUCTIONS FROM THE EROSION AND SEDIMENT CONTROLS INSTALLED AT YOUR SITE, AND
  - (2) INCLUDE THE RESULTS OF CALCULATIONS SHOWING THAT THE ADDITIONAL EROSION AND SEDIMENT CONTROLS INSTALLED AT YOUR SITE WILL MEET OR EXCEED THE SEDIMENT REMOVAL EFFICIENCY OF A 50-FOOT BUFFER

- I qualify for one of the exceptions in Part 2.1.2.a.v. (If you have checked this box, provide information on the applicable buffer exception that applies, below.)

### Buffer Exceptions

Which of the following exceptions to the buffer requirements applies to your site?

- There is no discharge of storm water to the surface water that is located 50 feet from my construction disturbances.

*(Note: If this exception applies, no further documentation is required for Section 4.1 of the Template.)*

- No natural buffer exists due to preexisting development disturbances that occurred prior to the initiation of planning for this project.

*(Note (1): If this exception applies, no further documentation is required for Section 2.2 of the Template.)*

*(Note (2): Where some natural buffer exists but portions of the area within 50 feet of the surface water are occupied by preexisting development disturbances, you must still comply with the one of the CGP Part 2.1.2.a compliance alternatives.)*

- For a “linear project” (defined in Appendix A), site constraints (e.g., limited right-of-way) make it infeasible for me to meet any of the CGP Part 2.1.2.a.v.3 compliance alternatives. Include documentation here of the following:

*(1) Why it is infeasible for you to meet one of the buffer compliance alternative, and (2) Buffer width retained and/or supplemental erosion and sediment controls to treat discharges to the surface water.*

- The project qualifies as “small residential lot” construction (defined in Part 2.1.2.a.v.3 and in Appendix D).

For Alternative 1 (see Appendix D, Part 2.3.a):

- INSERT WIDTH OF NATURAL BUFFER TO BE RETAINED
- INSERT APPLICABLE REQUIREMENTS BASED ON TABLE D-1
- INSERT DESCRIPTION OF HOW YOU WILL COMPLY WITH THESE REQUIREMENTS

For Alternative 2 (see Appendix D, Part 2.3.b):



- INSERT (1) THE ASSIGNED RISK LEVEL BASED ON APPLICABLE TABLE IN APP. D, PART 2.3.2.b, AND (2) THE PREDOMINANT SOIL TYPE AND AVERAGE SLOPE AT YOUR SITE
- INSERT APPLICABLE REQUIREMENTS BASED ON APP. D, TABLE D-2
- INSERT DESCRIPTION OF HOW YOU WILL COMPLY WITH THESE REQUIREMENTS

- Buffer disturbances are authorized under a CWA Section 404 permit.  
INSERT DESCRIPTION OF ANY EARTH DISTURBANCES THAT WILL OCCUR WITHIN THE BUFFER AREA

*(Note (1): If this exception applies, no further documentation is required for Section 2.2 of the Template.)*

*(Note (2): This exception only applies to the limits of disturbance authorized under the Section 404 permit, and does not apply to any upland portion of the construction project.)*

- Buffer disturbances will occur for the construction of a water-dependent structure or water access area (e.g., pier, boat ramp, and trail). INSERT DESCRIPTION OF ANY EARTH DISTURBANCES THAT WILL OCCUR WITHIN THE BUFFER AREA

*(Note (1): If this exception applies, no further documentation is required for Section 2.2 of the Template.)*

## SECTION 4: EROSION AND SEDIMENT CONTROLS

### 4.1 Minimize Disturbed Area and Protect Natural Features and Soil

Phase 1 will consist of clearing and grubbing the site and installing the SWPPP BMPs. Phase 2 will consist of the construction of the two building. Phase 3 will be the completion of the site including asphalt paving, sidewalk and landscaping.

### 4.2 Establish Perimeter Controls and Sediment Barriers

<b><i>BMP Description: Silt Fence</i></b>	
<b><i>Installation Schedule:</i></b>	June 2016
<b><i>Maintenance and Inspection:</i></b>	Weekly
<b><i>Responsible Staff:</i></b>	Mark Horton – SWPPP Inspector
<b><i>BMP Description: Inlet Protection</i></b>	
<b><i>Installation Schedule:</i></b>	June 2016
<b><i>Maintenance and Inspection:</i></b>	Weekly
<b><i>Responsible Staff:</i></b>	Mark Horton – SWPPP Inspector

### 4.3 Retain Sediment On-Site

<b><i>BMP Description: Silt Fence</i></b>	
<b><i>Installation Schedule:</i></b>	June 2016
<b><i>Maintenance and Inspection:</i></b>	Weekly
<b><i>Responsible Staff:</i></b>	Mark Horton – SWPPP Inspector
<b><i>BMP Description: Street Sweeping</i></b>	
<b><i>Installation Schedule:</i></b>	June 2016 to project completion
<b><i>Maintenance and Inspection:</i></b>	Weekly
<b><i>Responsible Staff:</i></b>	Mark Horton – SWPPP Inspector

<b><i>BMP Description: Inlet protection – Wattle/fabric</i></b>	
<b><i>Installation Schedule:</i></b>	June 2016
<b><i>Maintenance and Inspection:</i></b>	Weekly
<b><i>Responsible Staff:</i></b>	Mark Horton – SWPPP Inspector

#### **4.4 Establish Stabilized Construction Exits**

<b><i>BMP Description: Vehicle Tacking Pad</i></b>	
<b><i>Installation Schedule:</i></b>	June 2016
<b><i>Maintenance and Inspection:</i></b>	Weekly
<b><i>Responsible Staff:</i></b>	Mark Horton – SWPPP Inspector

<b><i>BMP Description:</i></b>	
<b><i>Installation Schedule:</i></b>	
<b><i>Maintenance and Inspection:</i></b>	
<b><i>Responsible Staff:</i></b>	

#### **4.5 Protect Slopes**

<b><i>BMP Description: Tracking</i></b>	
<b><i>Installation Schedule:</i></b>	As needed
<b><i>Maintenance and Inspection:</i></b>	Weekly
<b><i>Responsible Staff:</i></b>	Mark Horton – SWPPP Inspector

<b><i>BMP Description:</i></b>	
<b><i>Installation Schedule:</i></b>	
<b><i>Maintenance and Inspection:</i></b>	
<b><i>Responsible Staff:</i></b>	

#### 4.6 Stockpiled Sediment or Soil

***BMP Description: Cover stockpiles w/ Geotextiles***

<b><i>Installation Schedule:</i></b>	As needed
<b><i>Maintenance and Inspection:</i></b>	Weekly
<b><i>Responsible Staff:</i></b>	Mark Horton – SWPPP Inspector

***BMP Description: Place berms at base of stockpiles***

<b><i>Installation Schedule:</i></b>	As needed
<b><i>Maintenance and Inspection:</i></b>	Weekly
<b><i>Responsible Staff:</i></b>	Mark Horton - SWPPP Inspector

#### 4.7 Minimize Dust

***BMP Description: Water site and stock piles***

<b><i>Installation Schedule:</i></b>	As needed
<b><i>Maintenance and Inspection:</i></b>	Weekly
<b><i>Responsible Staff:</i></b>	Site Foreman

***BMP Description:***

<b><i>Installation Schedule:</i></b>	
<b><i>Maintenance and Inspection:</i></b>	
<b><i>Responsible Staff:</i></b>	

#### 4.8 Topsoil

***BMP Description:***

<b><i>Installation Schedule:</i></b>	
<b><i>Maintenance and Inspection:</i></b>	
<b><i>Responsible Staff:</i></b>	

***BMP Description:***

<b><i>Installation Schedule:</i></b>	
<b><i>Maintenance and Inspection:</i></b>	
<b><i>Responsible Staff:</i></b>	

**4.9 Soil Compaction**

***BMP Description:***

<b><i>Installation Schedule:</i></b>	
<b><i>Maintenance and Inspection:</i></b>	
<b><i>Responsible Staff:</i></b>	

***BMP Description:***

<b><i>Installation Schedule:</i></b>	
<b><i>Maintenance and Inspection:</i></b>	
<b><i>Responsible Staff:</i></b>	

**4.10 High Altitude/Heavy Snows**

<b>Date Snow is Expected</b>	<b>Date of High Altitude/Heavy Snow Conditions BMPs to be Installed</b>	<b>Date of First Heavy Snow</b>
Not expected	Scheduled:	
	Actual:	

***BMP Description: N/A***

<b><i>Installation Schedule:</i></b>	
<b><i>Maintenance and Inspection:</i></b>	
<b><i>Responsible Staff:</i></b>	

---

---

<b><i>BMP Description:</i></b>	
<b><i>Installation Schedule:</i></b>	
<b><i>Maintenance and Inspection:</i></b>	
<b><i>Responsible Staff:</i></b>	

---

#### **4.11 Linear Activities**

Description of why perimeter controls are not practicable.

#### **4.12 Chemical Treatment**

##### **Soil Types**

List all the soil types (including soil types expected to be found in fill material) that are expected to be exposed during construction and that will be discharged to locations where chemicals will be applied: [Unknown](#)

##### **Treatment Chemicals**

List all treatment chemicals that will be used at the site and explain why these chemicals are suited to the soil characteristics:

Describe the dosage of all treatment chemicals you will use at the site or the methodology you will use to determine dosage:

Provide information from any applicable Material Safety Data Sheets (MSDS):

Describe how each of the chemicals will stored:

Include references to applicable state or local requirements affecting the use of treatment chemicals, and copies of applicable manufacturer's specifications regarding the use of your specific treatment chemicals and/or chemical treatment systems:

##### **Special Controls for Cationic Treatment Chemicals (if applicable)**

If you have been authorized by the Division of Water Quality to use cationic treatment chemicals, include the official DWQ authorization letter or other communication, and identify the specific controls and implementation procedures you are required to implement to ensure that your use of cationic treatment chemicals will not lead to a violation of water quality standards:

##### **Schematic Drawings of Storm Water Controls/Chemical Treatment Systems**

Provide schematic drawings of any chemically-enhanced storm water controls or chemical treatment systems to be used for application of treatment chemicals:

**Training**

Describe the training that personnel who handle and apply chemicals have received prior to permit coverage, or will receive prior to the use of treatment chemicals:

**4.13 Stabilize Soils**

<b>BMP Description: Asphalt</b>	
<input checked="" type="checkbox"/> <b>Permanent</b> <span style="margin-left: 150px;"><input type="checkbox"/> <b>Temporary</b></span>	
<b>Installation Schedule:</b>	Project completion
<b>Maintenance and Inspection:</b>	Weekly
<b>Responsible Staff:</b>	Mark Horton – SWPPP Inspector

<b>BMP Description: Concrete</b>	
<input checked="" type="checkbox"/> <b>Permanent</b> <span style="margin-left: 150px;"><input type="checkbox"/> <b>Temporary</b></span>	
<b>Installation Schedule:</b>	Project Completion
<b>Maintenance and Inspection:</b>	Weekly
<b>Responsible Staff:</b>	Mark Horton – SWPPP Inspector

**4.14 Final Stabilization**

<b>BMP Description: Asphalt</b>	
<b>Installation Schedule:</b>	Project Completion
<b>Maintenance and Inspection:</b>	Weekly
<b>Responsible Staff:</b>	Mark Horton – SWPPP Inspector

<b>BMP Description: Seeding</b>	
<b>Installation Schedule:</b>	Project Completion
<b>Maintenance and Inspection:</b>	Weekly
<b>Responsible Staff:</b>	Mark Horton – SWPPP Inspector

SECTION 5: POLLUTION PREVENTION

**5.1 Spill Prevention and Response**

Fuel will be stored in a proper manner with impermeable membranes under any tanks.

Any discharges in 24 hours equal to or in excess of the reportable quantities listed in 40 CFR 117, 40 CFR 110, and 40 CFR 302 will be reported to the National Response Center and the Division of Water Quality (DWQ) as soon as practical after knowledge of the spill is known to the permittees. The permittee shall submit within 14 calendar days of knowledge of the release a written description of: the release (including the type and estimate of the amount of material released), the date that such release occurred, the circumstances leading to the release, and measures taken and/or planned to be taken to the Division of Water Quality (DWQ), 288 North 1460 West, P.O. Box 144870, Salt Lake City, Utah 84114-4870. The Storm Water Pollution Prevention Plan must be modified within 14 calendar days of knowledge of the release to provide a description of the release, the circumstances leading to the release, and the date of the release. In addition, the plan must be reviewed to identify measures to prevent the reoccurrence of such releases and to respond to such releases, and the plan must be modified where appropriate.

Agency	Phone Number
National Response Center	(800) 424-8802
Division of Water Quality ( DWQ) 24-Hr Reporting	(801) 538-6146 (801) 536-4123
Utah Department of Health Emergency Response	(801) 580-6681

Material	Media Released To	Reportable Quantity
Engine oil, fuel, hydraulic & brake fluid	Land	25 gallons
Paints, solvents, thinners	Land	100 lbs (13 gallons)
Engine oil, fuel, hydraulic & brake fluid	Water	Visible Sheen
Antifreeze, battery acid, gasoline, engine degreasers	Air, Land, Water	100 lbs (13 gallons)
Refrigerant	Air	1 lb

**5.2 Construction and Domestic Waste**



***BMP Description: Portable Toilets staked down***

<b><i>Installation Schedule:</i></b>	June 2016
<b><i>Maintenance and Inspection:</i></b>	Weekly
<b><i>Responsible Staff:</i></b>	Mark Horton – SWPPP Inspector

***BMP Description:***

<b><i>Installation Schedule:</i></b>	
<b><i>Maintenance and Inspection:</i></b>	
<b><i>Responsible Staff:</i></b>	

Repeat as needed

**5.3 Washing of Applicators and Containers used for Concrete, Paint or Other Materials**

***BMP Description: Concrete Washout***

<b><i>Installation Schedule:</i></b>	June 2016
<b><i>Maintenance and Inspection:</i></b>	Weekly
<b><i>Responsible Staff:</i></b>	Mark Horton – SWPPP Inspector

***BMP Description:***

<b><i>Installation Schedule:</i></b>	
<b><i>Maintenance and Inspection:</i></b>	
<b><i>Responsible Staff:</i></b>	

**5.4 Establish Proper Building Material Staging Areas**

***BMP Description:***

<b><i>Installation Schedule:</i></b>	
<b><i>Maintenance and Inspection:</i></b>	
<b><i>Responsible Staff:</i></b>	

<b><i>BMP Description:</i></b>	
<b><i>Installation Schedule:</i></b>	
<b><i>Maintenance and Inspection:</i></b>	
<b><i>Responsible Staff:</i></b>	

### **5.5 Establish Proper Equipment/Vehicle Fueling and Maintenance Practices**

<b><i>BMP Description: Fueling in designated areas only</i></b>	
<b><i>Installation Schedule:</i></b>	June 2016
<b><i>Maintenance and Inspection:</i></b>	Weekly
<b><i>Responsible Staff:</i></b>	Site Super

<b><i>BMP Description: Place fuel tanks in containment device</i></b>	
<b><i>Installation Schedule:</i></b>	As needed
<b><i>Maintenance and Inspection:</i></b>	Weekly
<b><i>Responsible Staff:</i></b>	Mark Horton – SWPPP Inspector

### **5.6 Control Equipment/Vehicle Washing**

<b><i>BMP Description: No Vehicle Washing On Site</i></b>	
<b><i>Installation Schedule:</i></b>	June 2016
<b><i>Maintenance and Inspection:</i></b>	Weekly
<b><i>Responsible Staff:</i></b>	Mark Horton – SWPPP Inspection

<b><i>BMP Description:</i></b>	
<b><i>Installation Schedule:</i></b>	
<b><i>Maintenance and Inspection:</i></b>	
<b><i>Responsible Staff:</i></b>	

Repeat as needed

**5.7 Pesticides, Herbicides, Insecticides, Fertilizers, and Landscape Materials**

<b><i>BMP Description: No Pesticide Or Herbicides on site</i></b>	
<b><i>Installation Schedule:</i></b>	
<b><i>Maintenance and Inspection:</i></b>	
<b><i>Responsible Staff:</i></b>	
<b><i>BMP Description:</i></b>	
<b><i>Installation Schedule:</i></b>	
<b><i>Maintenance and Inspection:</i></b>	
<b><i>Responsible Staff:</i></b>	

**5.8 Other Pollution Prevention Practices**

<b><i>BMP Description:</i></b>	
<b><i>Installation Schedule:</i></b>	
<b><i>Maintenance and Inspection:</i></b>	
<b><i>Responsible Staff:</i></b>	
<b><i>BMP Description:</i></b>	
<b><i>Installation Schedule:</i></b>	
<b><i>Maintenance and Inspection:</i></b>	
<b><i>Responsible Staff:</i></b>	

## **SECTION 6: INSPECTIONS & CORRECTIVE ACTIONS**

### **6.1 Inspections**

- 1. *Inspection Personnel:*** Identify the person(s) who will be responsible for conducting inspections and describe their qualifications:

[Mark Horton, RSI certified inspector](#)

- 2. *Inspection Schedule and Procedures:***

Describe the inspection schedules and procedures you have developed for your site (include frequency of inspections for each BMP or group of BMPs, indicate when you will inspect, e.g., before/during/and after rain events, spot inspections):

[Weekly](#)

Describe the general procedures for correcting problems when they are identified. Include responsible staff and time frames for making corrections:

Attach a copy of the inspection report you will use for your site.

[See attached Inspection Report](#)

Reduction in Inspection Frequency (if applicable)

For the reduction in inspections resulting from stabilization:

For the reduction in inspections in arid, semi-arid, or drought-stricken areas:

For reduction in inspections due to frozen conditions:

### **6.2 Corrective Actions**

Corrective Action Log: See the Appendix

### **6.3 Delegation of Authority**

**Duly Authorized Representative(s) or Position(s):**

E.K. Bailey Construction:  
Mark Horton:  
Safety/ SWPPP Inspector:  
1243 N. Washington Blvd.  
Ogden, UT 84404  
801-782-4748

Attach a copy of the signed delegation of authority form in Appendix K.

## **SECTION 7: TRAINING AND RECORDKEEPING**

### **7.1 Training**

Individual(s) Responsible for Training:

Mark Horton

Describe Training Conducted:

- General storm water and BMP awareness training for staff and subcontractors:
  
- Detailed training for staff and subcontractors with specific stormwater responsibilities:

<b>Training Attendee Name</b>	<b>Title of Training</b>	<b>Duration</b>	<b>Date of Training</b>

Additional training documentation should be included in Appendix J.

### **7.2 Recordkeeping**

Records will be retained for a minimum period of at least 3 years after the permit is terminated.

Date(s) when major grading activities occur:

Date(s) when construction activities temporarily or permanently cease on a portion of the site:

Date(s) when an area is either temporarily or permanently stabilized:

### **7.3 *Log of Changes to the SWPPP***

See the appendix

## SECTION 8: WATER QUALITY

### 8.2 Discharge Information

Does your project/site discharge storm water into a Municipal Separate Storm Sewer System (MS4)?  Yes  No

List the MS4 that receives the discharge from the construction project: Clearfield City Storm System

Are there any surface waters that are located within 50 feet of your construction disturbances?

Yes  No

List the water body:

### 8.3 Receiving Waters

**Table 1 – Names of Receiving Waters**

Name(s) of the first surface water that receives storm water directly from your site and/or from the MS4. (note: multiple rows provided where your site has more than one point of discharge that flows to different surface waters)	
<b>1.</b>	<b>Site drains to existing storm drains</b>
<b>2.</b>	
<b>3.</b>	
<b>4.</b>	
<b>5.</b>	
<b>6.</b>	

### 8.4 Impaired Waters

	Is this surface water listed as "impaired"?	If you answered yes, then answer the following:		
		What pollutant(s) are causing the impairment?	Has a TMDL been completed?	Pollutant(s) for which there is a TMDL
1.	<input type="checkbox"/> Yes <input type="checkbox"/> No		<input type="checkbox"/> Yes <input type="checkbox"/> No	
2.	<input type="checkbox"/> Yes <input type="checkbox"/> No		<input type="checkbox"/> Yes <input type="checkbox"/> No	
3.	<input type="checkbox"/> Yes <input type="checkbox"/> No		<input type="checkbox"/> Yes <input type="checkbox"/> No	
4.	<input type="checkbox"/> Yes <input type="checkbox"/> No		<input type="checkbox"/> Yes <input type="checkbox"/> No	
5.	<input type="checkbox"/> Yes <input type="checkbox"/> No		<input type="checkbox"/> Yes <input type="checkbox"/> No	
6.	<input type="checkbox"/> Yes <input type="checkbox"/> No		<input type="checkbox"/> Yes <input type="checkbox"/> No	



### 8.5 High Water Quality

**Table 3 – High Water Quality** (Answer the following for each surface water listed in Table 1 above)

	Is this surface water designated as High Water Quality? (see Appendix C)		If you answered yes, specify which category the surface water is designated as?	
1.	<input type="checkbox"/> Yes	<input type="checkbox"/> No	<input type="checkbox"/> Category 1	<input type="checkbox"/> Category 2
2.	<input type="checkbox"/> Yes	<input type="checkbox"/> No	<input type="checkbox"/> Category 1	<input type="checkbox"/> Category 2
3.	<input type="checkbox"/> Yes	<input type="checkbox"/> No	<input type="checkbox"/> Category 1	<input type="checkbox"/> Category 2
4.	<input type="checkbox"/> Yes	<input type="checkbox"/> No	<input type="checkbox"/> Category 1	<input type="checkbox"/> Category 2
5.	<input type="checkbox"/> Yes	<input type="checkbox"/> No	<input type="checkbox"/> Category 1	<input type="checkbox"/> Category 2
6.	<input type="checkbox"/> Yes	<input type="checkbox"/> No	<input type="checkbox"/> Category 1	<input type="checkbox"/> Category 2

### 8.6 Dewatering Practices

<b><i>BMP Description:</i></b> Not Applicable	
<b><i>Installation Schedule:</i></b>	
<b><i>Maintenance and Inspection:</i></b>	
<b><i>Responsible Staff:</i></b>	
<b><i>BMP Description:</i></b>	
<b><i>Installation Schedule:</i></b>	
<b><i>Maintenance and Inspection:</i></b>	
<b><i>Responsible Staff:</i></b>	

### 8.7 Control Storm Water Flowing onto and through the Project

<b><i>BMP Description:</i></b> Silt Fence	
<b><i>Installation Schedule:</i></b>	June 2016

<b>Maintenance and Inspection:</b>	Weekly
<b>Responsible Staff:</b>	Site Super
<b>BMP Description:</b>	
<b>Installation Schedule:</b>	
<b>Maintenance and Inspection:</b>	
<b>Responsible Staff:</b>	

### 8.8 Protect Storm Drain Inlets

<b>BMP Description: Inlet Protection – Wattles</b>	
<b>Installation Schedule:</b>	June 2016
<b>Maintenance and Inspection:</b>	Weekly
<b>Responsible Staff:</b>	Mark Horton – SWPPP Inspector
<b>BMP Description:</b>	
<b>Installation Schedule:</b>	
<b>Maintenance and Inspection:</b>	
<b>Responsible Staff:</b>	

## SECTION 9: POST-CONSTRUCTION BMPs

<i>BMP Description:</i>	
<i>Installation Schedule:</i>	
<i>Maintenance and Inspection:</i>	
<i>Responsible Staff:</i>	
<i>BMP Description:</i>	
<i>Installation Schedule:</i>	
<i>Maintenance and Inspection:</i>	
<i>Responsible Staff:</i>	

## SECTION 10: CERTIFICATION

### *Professional/SWPPP Author*

I certify under penalty of law that this document and all attachments were prepared under my direction or supervision in accordance with a system designed to assure that qualified personnel properly gathered and evaluated the information submitted. Based on my inquiry of the person or persons who manage the system, or those persons directly responsible for gathering the information, the information submitted is, to the best of my knowledge and belief, true, accurate, and complete. I am aware that there are significant penalties for submitting false information, including the possibility of fine and imprisonment for knowing violations.

Name: Kraig Urry Title: Project Engineer

Signature: \_\_\_\_\_ Date: May 26, 2016

## **SWPPP APPENDICES**

Attach the following documentation to the SWPPP:

***Appendix A – General Location Map***

***Appendix B – Site Maps***

***Appendix C – Construction General Permit***

***Appendix D – NOI and Acknowledgement Letter from EPA/State/MS4***

***Appendix E – Inspection Reports***

***Appendix F – Corrective Action Log (or in Part 5.3)***

***Appendix G – SWPPP Amendment Log (or in Part 7.4)***

***Appendix H – Subcontractor Certifications/Agreements***

***Appendix I – Grading and Stabilization Activities Log***

***Appendix J – Training Log***

***Appendix K – Delegation of Authority***

***Appendix L – Additional Information (i.e. Documentation; other permits such as dewatering, stream alteration, wetland; and out of date swppp documents)***

***Appendix M – BMP Specifications***

# SANDHILL CRANE Cluster Subdivision

## Storm Water Pollution Prevention Plan Exhibit

EDEN, WEBER COUNTY, UTAH  
FEBRUARY 2015

Appendix A & B

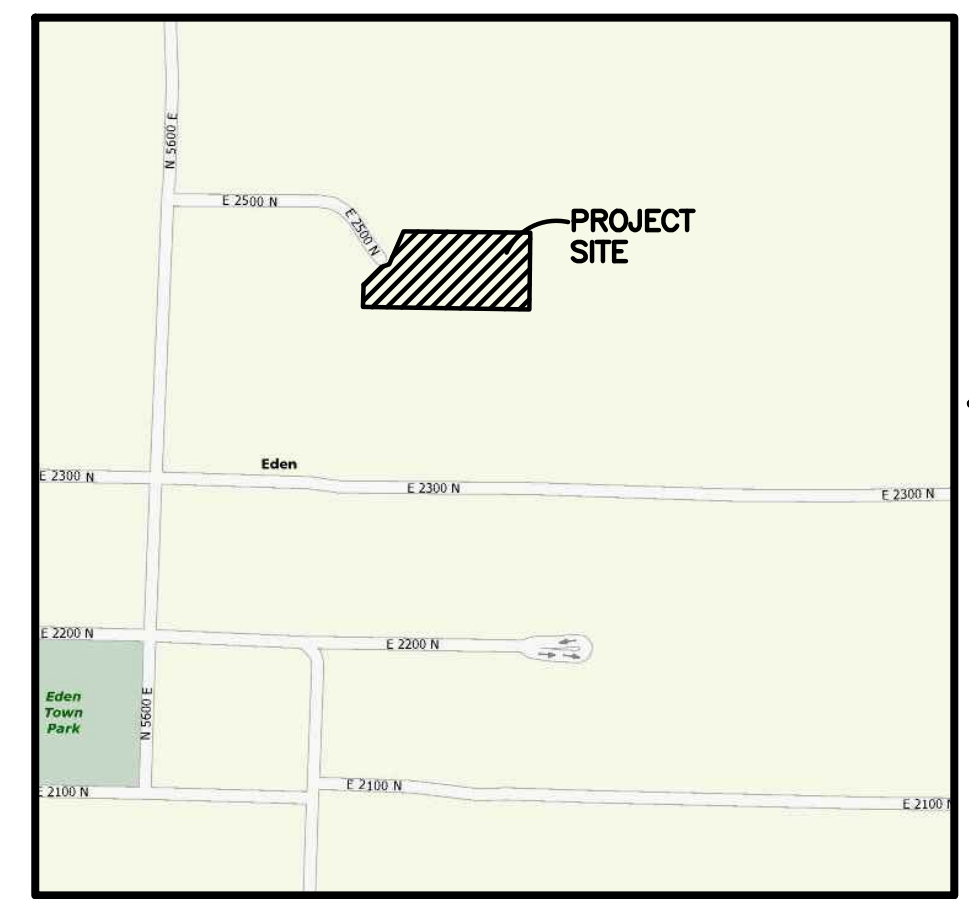

Vicinity Map  
NOT TO SCALE

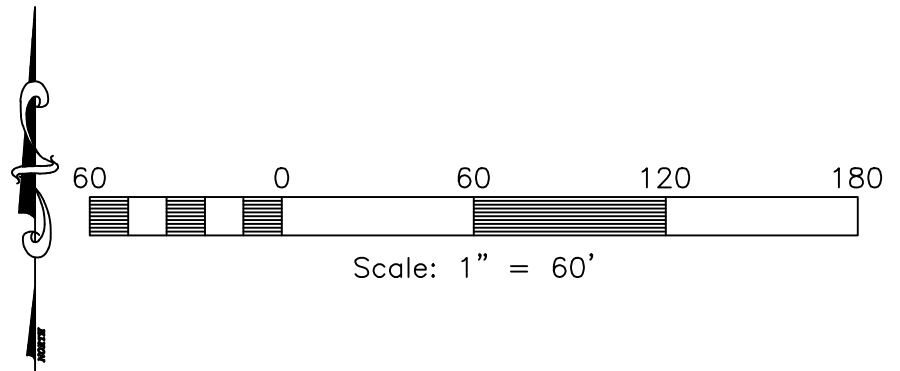
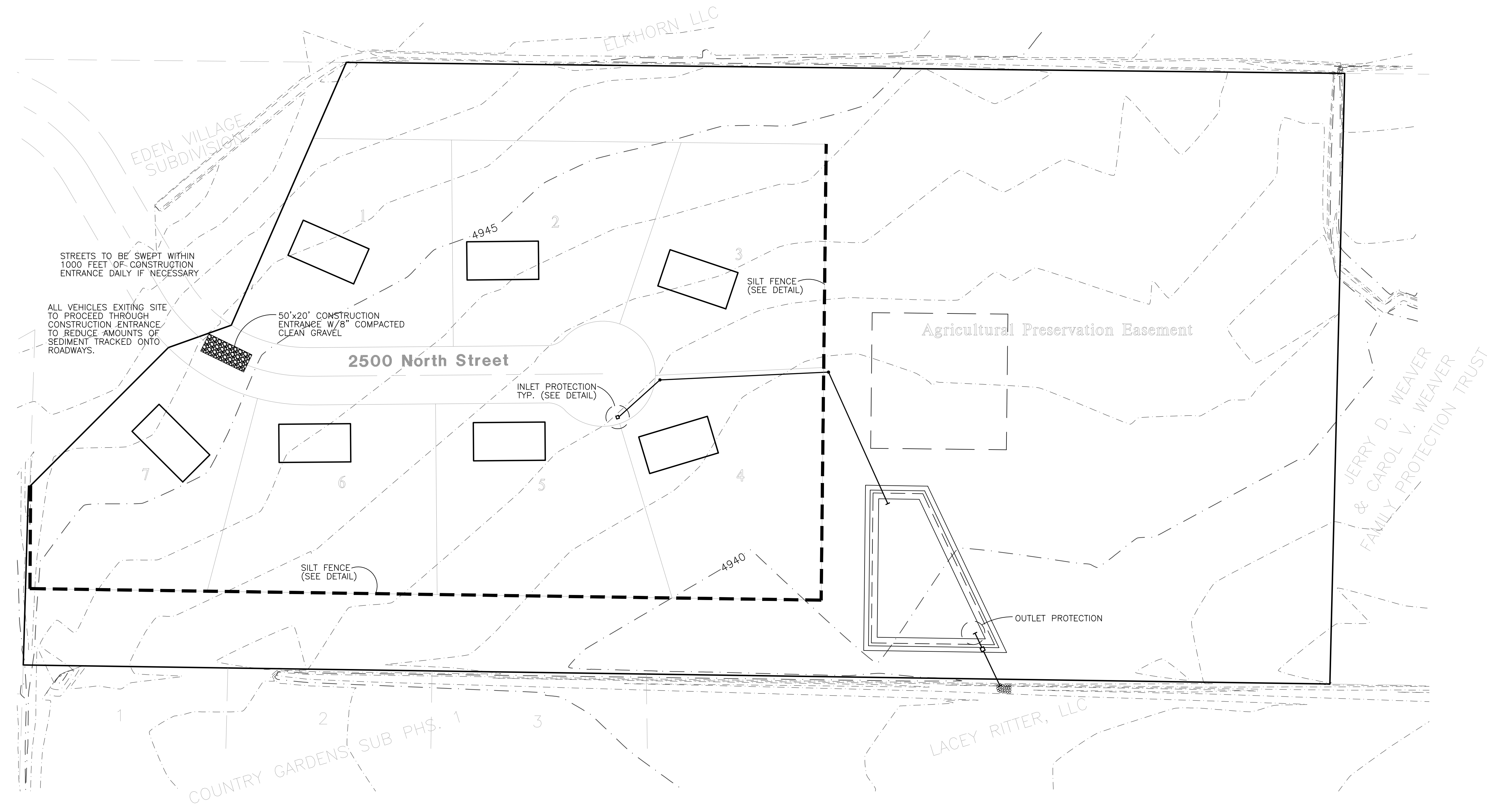

Construction Activity Schedule	
- PROJECT LOCATION.....	EDEN, WEBER COUNTY, UTAH
- PROJECT BEGINNING DATE.....	FEBRUARY 2015
- BMP'S DEPLOYMENT DATE.....	FEBRUARY 2015
- STORM WATER MANAGEMENT CONTACT / INSPECTOR.....	BLAKE WAHLEN (801) 510-6136
- SPECIFIC CONSTRUCTION SCHEDULE INCLUDING BMP CONSTRUCTION SCHEDULE TO BE INCLUDED WITH SWPPP BY OWNER/DEVELOPER	

**Reeve & Associates, Inc.**  
920 CHAMBERS STREET, SUITE 14, OGDEN, UTAH 84403  
TEL: (801) 621-2100 FAX: (801) 621-2666 www.reeve-assoc.com  
LAND PLANNERS • CIVIL ENGINEERS • LAND SURVEYORS  
TRAFFIC ENGINEERS • STRUCTURAL ENGINEERS • LANDSCAPE ARCHITECTS

DATE	DESCRIPTION
3-2-15	RH City Comments
4-6-15	JP City Comments
02/04/16	JM City Comments

**Sandhill Crane Cluster Subdivision**  
EDEN, WEBER COUNTY, UTAH

**Storm Water Pollution Prevention Plan Exhibit**

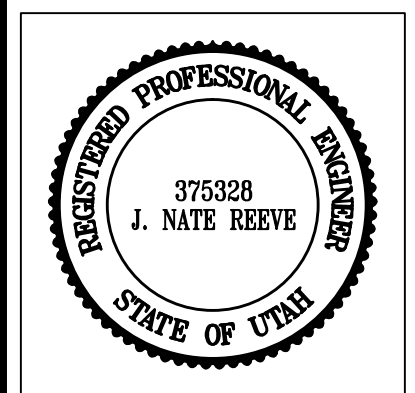

<b>Project Info.</b>	
Engineer:	J. NATE REEVE, P.E.
Drafter:	R. HANSEN
Begin Date:	FEBRUARY 4, 2015
Name:	SANDHILL CRANE CLUSTER SUBDIVISION
Number:	6460-01

Sheet	<b>6</b>
<b>5</b>	Sheets



**Notes:**

- Describe all BMP's to protect storm water inlets:  
All storm water inlets to be protected by straw wattle barriers, or gravel bags (see detail).
- Describe BMP's to eliminate/reduce contamination of storm water from:
  - Equipment / building / concrete wash areas:  
To be performed in designated areas only and surrounded with silt fence barriers.
  - Soil contaminated by soil amendments:  
If any contaminants are found or generated, contact environmental engineer and contacts listed.
  - Areas of contaminated soil:  
If any contaminants are found or generated, contact environmental engineer and contacts listed.
  - Fueling area:  
To be performed in designated areas only and surrounded with silt fence.
  - Vehicle maintenance areas:  
To be performed in designated areas only and surrounded with silt fence.
  - Vehicle parking areas:  
To be performed in designated areas only and surrounded with silt fence.
  - Equipment storage areas:  
To be performed in designated areas only and surrounded with silt fence.
  - Materials storage areas:  
To be performed in designated areas only and surrounded with silt fence.
  - Waste containment areas:  
To be performed in designated areas only and surrounded with silt fence.
  - Service areas:  
To be performed in designated areas only and surrounded with silt fence.
- BMP's for wind erosion:  
Stockpiles and site as needed to be watered regularly to eliminate / control wind erosion
- Construction Vehicles and Equipment:
  - Maintenance
    - Maintain all construction equipment to prevent oil or other fluid leaks.
    - Keep vehicles and equipment clean, prevent excessive build-up of oil and grease.
    - Regularly inspect on-site vehicles and equipment for leaks, and repair immediately.
    - Check incoming vehicles and equipment (including delivery trucks, and employee and subcontractor vehicles) for leaking oil and fluids. Do not allow leaking vehicles or equipment on-site.
    - Segregate and recycle wastes, such as greases, used oil or oil filters, antifreeze, cleaning solutions, automotive batteries, hydraulic, and transmission fluids.
  - Fueling
    - If fueling must occur on-site, use designated areas away from drainage.
    - Locate on-site fuel storage tanks within a bermed area designed to hold the tank volume.
    - Cover retention area with an impervious material and install in a manner to ensure that any spills will be contained in the retention area. To catch spills or leaks when removing or changing fluids.
    - Use drip pans for any oil or fluid changes.
  - Washing
    - Use as little water as possible to avoid installing erosion and sediment controls for the wash area.
    - If washing must occur on-site, use designated, bermed wash areas to prevent waste water discharge into storm water, creeks, rivers, and other water bodies.
    - Use phosphate-free, biodegradable soaps.
    - Do not permit steam cleaning on-site.
- Spill Prevention and Control
  - Minor Spills:  
Minor spills are those which are likely to be controlled by on-site personnel. After contacting local emergency response agencies, the following actions should occur upon discovery of a minor spill:
    - Contain the spread of the spill.
    - If the spill occurs on paved or impermeable surfaces, clean up using "dry" methods (i.e. absorbent materials, cat litter, and / or rags).
    - If the spill occurs in dirt areas, immediately contain the spill by constructing an earth dike. Dig up property dispose of contaminated soil.
    - If the spill occurs during rain, cover the impacted area to avoid runoff.
    - Record all steps taken to report and contain spill.
  - Major Spills:  
On-site personnel should not attempt to control major spills until the appropriate and qualified emergency response staff have arrived at the site. For spills of federal reportable quantities, also notify the National Response Center at (800) 424-8802. A written report should be sent to all notified authorities. Failure to report major spills can result in significant fines and penalties.
- Post Roadway / Utility Construction
  - Maintain good housekeeping practices.
  - Enclose or cover building material storage areas.
  - Properly store materials such as paints and solvents.
  - Store dry and wet materials under cover, away from drainage areas.
  - Avoid mixing excess amounts of fresh concrete or cement on-site.
  - Perform washout of concrete trucks offsite or in designated areas only.
  - Do not wash out concrete trucks into storm drains, open ditches, streets or streams.
  - Do not place material or debris into streams, gutters or catch basins that stop or reduce the flow of runoff water.
  - All public streets and storm drain facilities shall be maintained free of building materials, mud and debris caused by grading or construction operations. Roads will be swept within 1000' of construction entrance daily, if necessary.
  - Install straw wattle around all inlets contained within the development and all others that receive runoff from the development.
- Erosion Control Plan Notes
  - The contractor will designate an emergency contact that can be reached 24 hours a day 7 days a week.
  - A stand-by crew for emergency work shall be available at all times during potential rain or snow runoff events. Necessary materials shall be available on site and stockpiled at convenient locations to facilitate rapid construction of emergency devices when rain or runoff is eminent.
  - Erosion control devices shown on the plans and approved for the project may not be removed without approval of the engineer of record. If devices are removed, no work may continue that have the potential of erosion without consulting the engineer of record. If deemed necessary erosion control should be reestablished before this work begins.
  - Graded areas adjacent to fill slopes located at the site perimeter must drain away from the top of the slope at the conclusion of each working day. This should be confirmed by survey or other means acceptable to the engineer of record.
  - All silt and debris shall be removed from all devices within 24 hours after each rain or runoff event.
  - Except as otherwise approved by the inspector, all removable protective devices shown shall be in place at the end of each working day and through weekends until removal of the system is approved.
  - All loose soil and debris, which may create a potential hazard to offsite property, shall be removed from the site as directed by the Engineer of record of the governing agency.
  - The placement of additional devices to reduce erosion damage within the site is left to the discretion of the Engineer of record.
  - Desilting basins may not be removed or made inoperable without the approval of the engineer of record and the governing agency.
  - Erosion control devices will be modified as need as the project progresses, and plans of these changes submitted for approval by the engineer of record and the governing agency.
- Conduct a minimum of one inspection of the erosion and sediment controls every two weeks. Maintain documentation on site.
  - Part III.D.4 of general permit UTR300000 identifies the minimum inspection requirements.
  - Part II.D.4.C identifies the minimum inspection report requirements.
  - failure to complete and/or document storm water inspections is a violation of part III.D.4 of Utah General Permit UTR 300000.

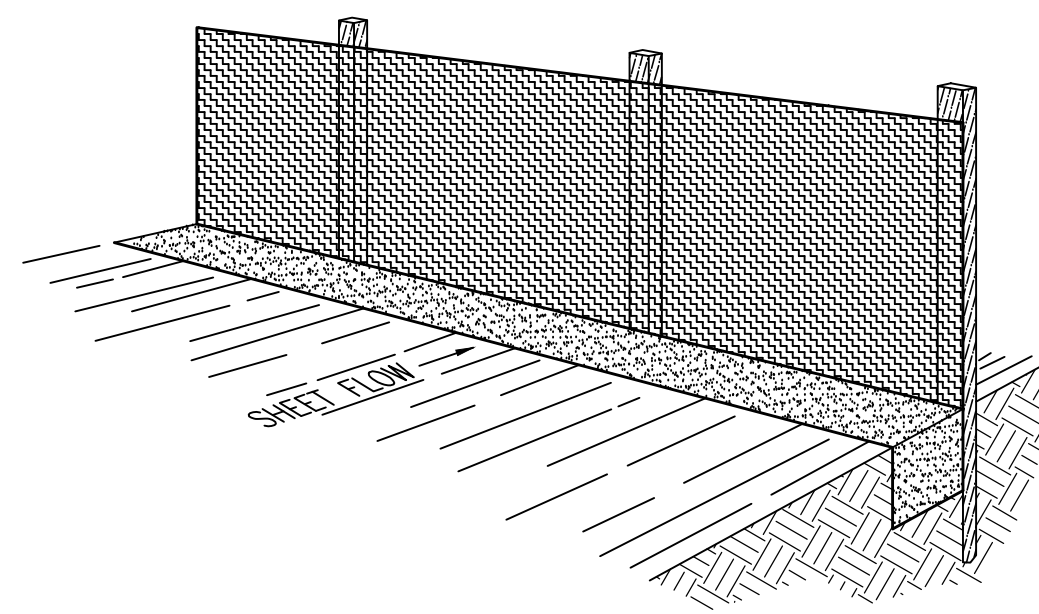

**Perspective View**

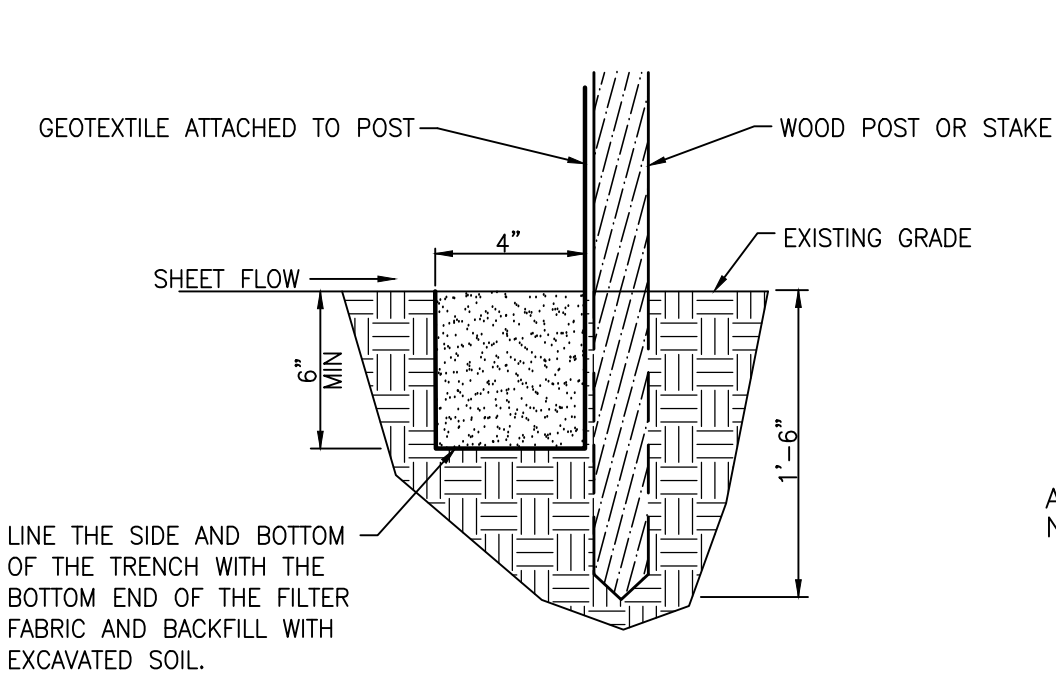

**Section**

**INSTALLATION**

The silt fence should be installed prior to major soil disturbances in the drainage area. The fence should be placed across the slope along a line of uniform elevation wherever flow of sediment is anticipated. Table 1 shows generally-recommended maximum slope lengths (slope spacing between fences) at various site grades for most silt fence applications.

TABLE 1: Recommended Maximum Slope Lengths for Silt Fence (Richardson & Middlebrooks, 1991)	
Slope Steepness (%)	Max. Slope Length m (ft)
<2%	30.5m (100ft)
2-5%	22.9m (75ft)
5-10%	15.2m (50ft)
10-20%	7.6m (25ft)
>20%	4.5m (15ft)

**PREFABRICATED SILT FENCE ROLLS**

- \*Excavate a minimum 15.2cm x 15.2cm (6"x6") trench at the desired location.
- \*Unroll the silt fence, positioning the post against the downstream wall of the trench.
- \*Adjacent rolls of silt fence should be joined by nesting the end post of one fence into the other. Before nesting the end posts, rotate each post until the geotextile is wrapped completely around the post, then abut the end posts to create a tight seal as shown in Figure 1.
- \*Drive posts into the ground until the required fence height and/or anchorage depth is obtained.
- \*Bury the loose geotextile at the bottom of the fence in the upstream trench and backfill with natural soil, tamping the backfill to provide good compaction and anchorage. Figure 2 illustrates a typical silt fence installation and anchor trench placement.

should generally be less than three (3) times the height of the fence.

- \*If a steel or plastic mesh is required to reinforce the geotextile, it shall have a minimum mesh opening of 15.2cm (6").
- \*Fasten the mesh to the upslope side of the posts using heavy duty wire staples, tie wires or hog strings. Extend the mesh into the bottom of the trench.
- \*The geotextile shall then be stapled or wired to the posts. An extra 20-50cm (8-20") of geotextile shall extend into the trench.

**INSPECTION**

- \*Inspect the silt fence daily during periods of rainfall, immediately after significant rainfall event and weekly during periods of no rainfall. Make any repairs immediately.
- \*When sediment deposits behind the silt fence are one-third of the fence height, remove and properly dispose of the silt accumulations. Avoid damage to the fabric during cleanout.

**REMOVAL**

- \*Silt fence should not be removed until construction ceases and the upslope area has been properly stabilized and/or revegetated.

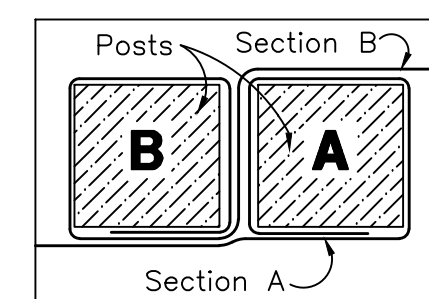
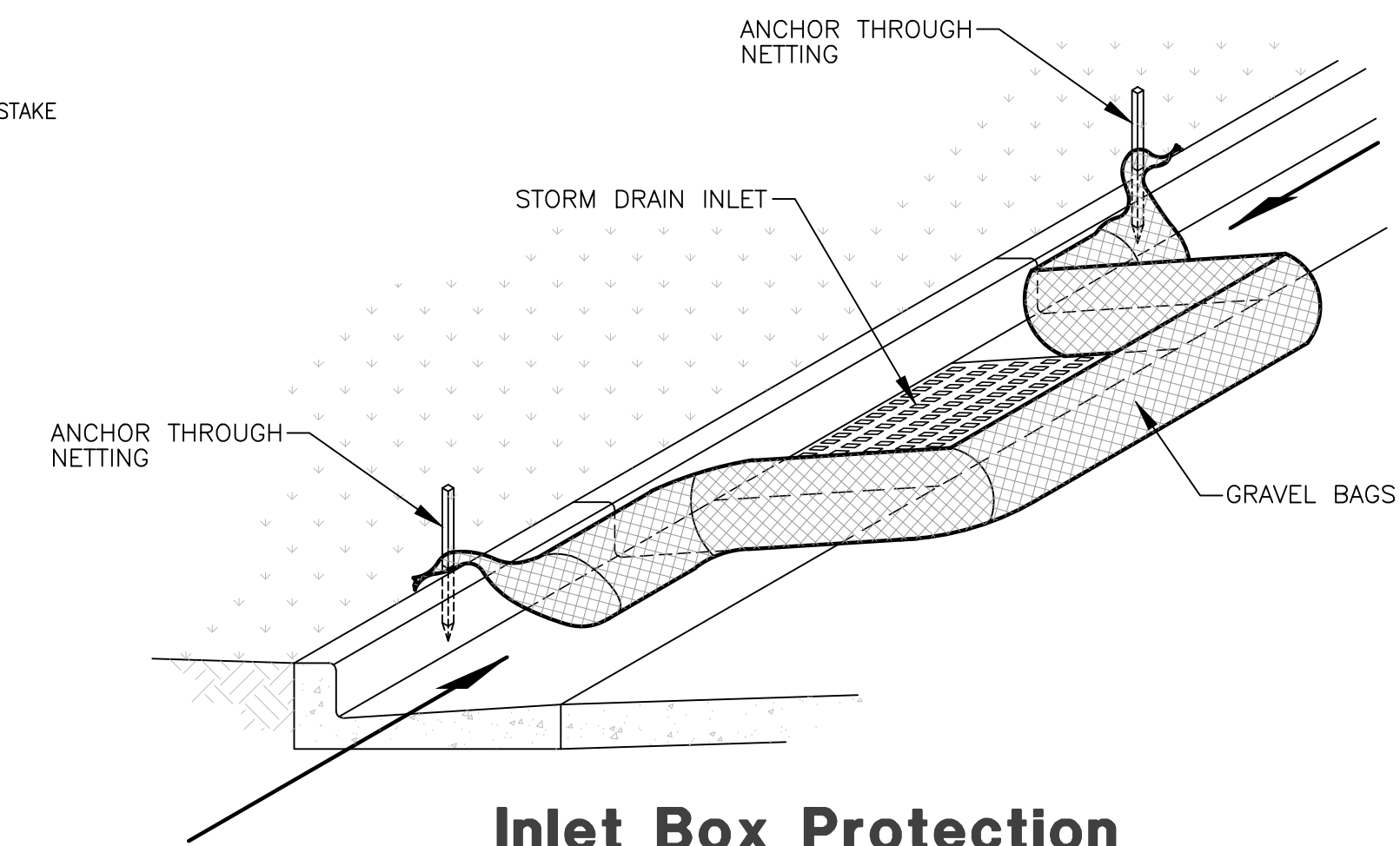

Figure 1:  
Top View of  
Roll-to-Roll Connection

**Silt Fence Detail**

SCALE: NONE



**Inlet Box Protection**

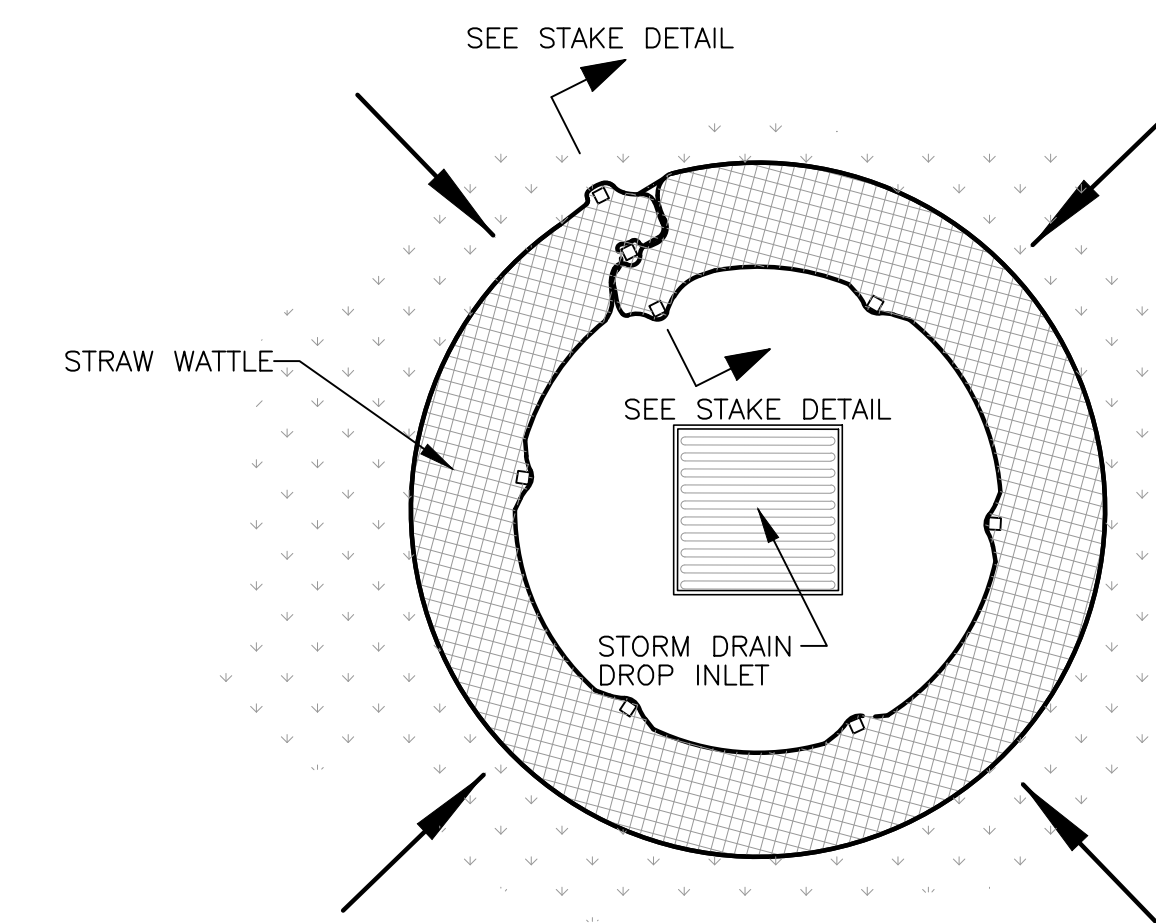

**Plan View**

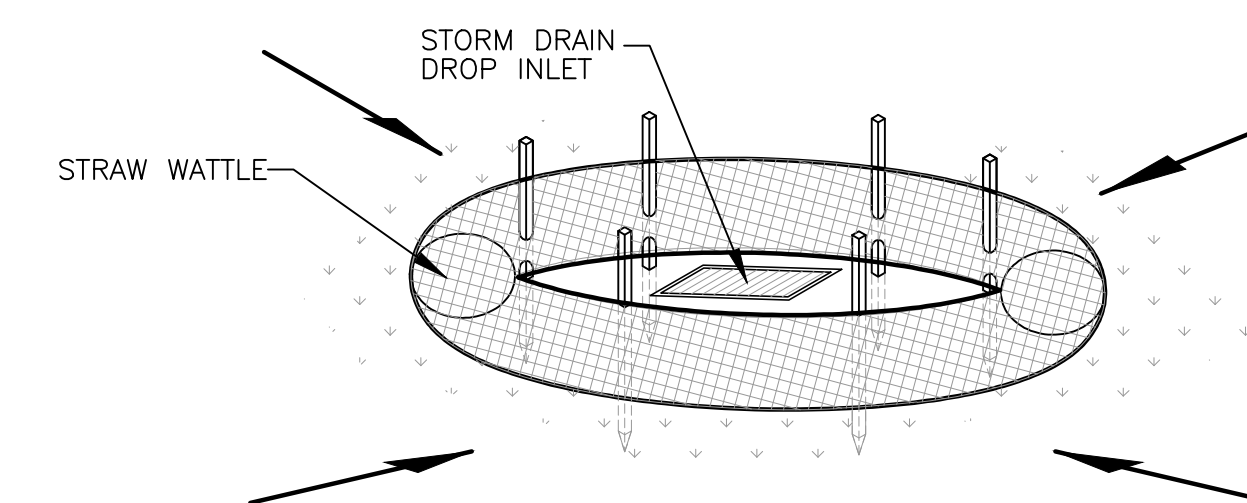

**Drop Inlet Protection**

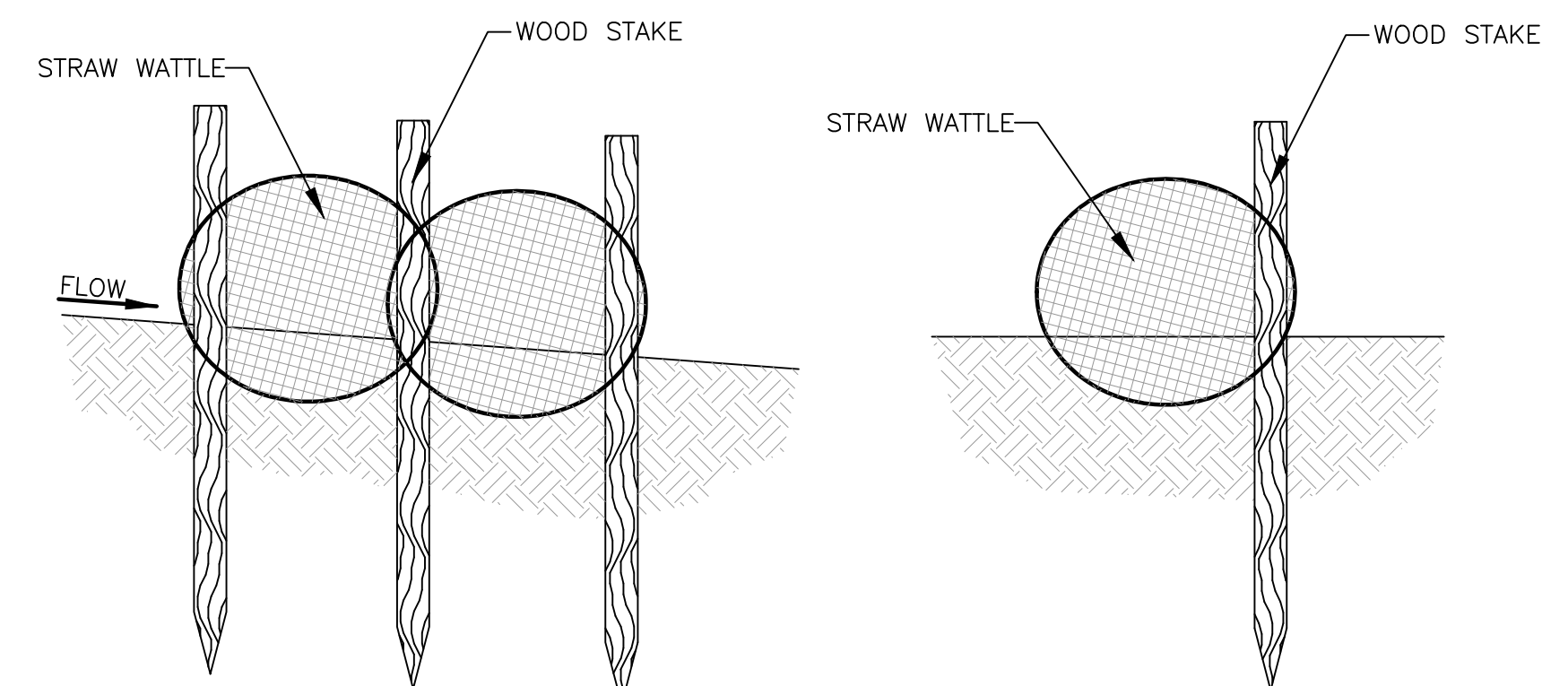

**Stake Detail**

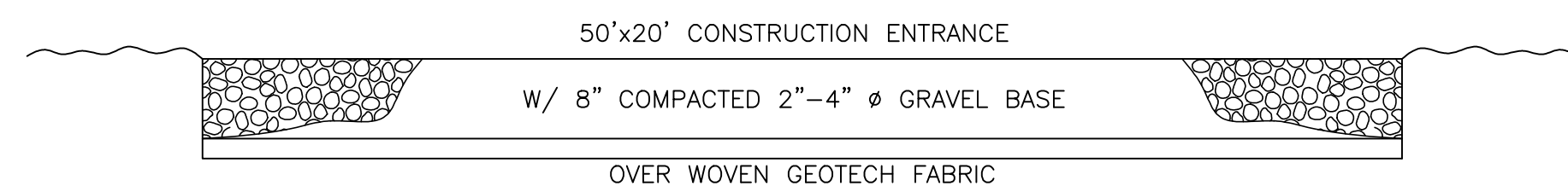

**Cross Section 50' x 20' Construction Entrance**

**Reeve & Associates, Inc.**  
 920 CHAMBERS STREET, SUITE 14, OGDEN, UTAH 84403  
 TEL: (801) 621-2100 FAX: (801) 621-2666 www.reeve-assoc.com  
**IRA**  
 LAND PLANNERS • CIVIL ENGINEERS • LAND SURVEYORS  
 PUBLIC ENGINEERS • LANDSCAPE ARCHITECTS

REVISIONS	DATE	DESCRIPTION
3-2-15	RH	City Comments
4-6-15	JP	City Comments
02/04/16	JM	City Comments

**Sandhill Crane Cluster Subdivision**  
 EDEN, WEBER COUNTY, UTAH  
**Storm Water Pollution Prevention Plan Details**

**REGISTERED PROFESSIONAL ENGINEER**  
 375328  
**J. NATE REEVE**  
 STATE OF UTAH

**Project Info.**

Engineer:	J. NATE REEVE, P.E.
Drafter:	R. HANSEN
Begin Date:	FEBRUARY 4, 2015
Name:	SANDHILL CRANE CLUSTER SUBDIVISION
Number:	6460-01

Sheet	<b>6</b>
<b>6</b>	Sheets



STATE OF UTAH  
DEPARTMENT OF ENVIRONMENTAL QUALITY  
DIVISION OF WATER QUALITY  
Utah Pollutant Discharge Elimination System (UPDES)  
General Permit for Discharges from Construction Activities  
UPDES Permit No. UTRC00000

This Permit is issued in compliance with the provisions of the Utah Water Quality Act, Title 19, Chapter 5, Utah Code Annotated 2004, as amended (the "Act") and the federal Water Pollution Control Act (33 U.S.c. §§ 1251 et. seq., as amended by the Water Quality Act of 1987, P.L. 100-4), and the rules and Regulations made pursuant to those statutes. This permit authorizes "owners/operators" of construction activities (defined in Part 1.1.1 and Appendix A) that meet the requirements of Part 1. of this Utah Pollutant Discharge Elimination System (UPDES) general permit, to discharge pollutants in accordance with the effluent limitations and conditions set forth herein. Permit coverage is required from the "commencement of earth-disturbing activities" (see Appendix A) until "final stabilization" (see Part 2.2.4).

This permit becomes effective on July 1, 2014.

This permit and the authorization to discharge expire at midnight on June 30, 2019.

Signed this 10 day of June, 2014

  
\_\_\_\_\_  
Walter L. Baker, P.E.  
Director

**Table of Contents**

**1. HOW TO OBTAIN PERMIT COVERAGE UNDER THE UTAH CGP..... 1**

**1.1. ELIGIBILITY CONDITIONS REQUIRED OF ALL PROJECTS..... 1**

**1.2. ELIGIBILITY CONDITIONS THAT APPLY DEPENDING ON TYPE OF PROJECT..... 3**

**1.3. TYPES OF DISCHARGES AUTHORIZED UNDER THIS PERMIT..... 4**

**1.4. SUBMITTING YOUR NOTICE OF INTENT (NOI) AND PERMIT FEE..... 5**

**1.5. REQUIREMENT TO POST A NOTICE OF YOUR PERMIT COVERAGE..... 8**

**2. EFFLUENT LIMITATIONS APPLICABLE TO ALL DISCHARGES FROM CONSTRUCTION SITES (including support activities)..... 9**

**2.1. EROSION AND SEDIMENT CONTROL REQUIREMENTS..... 9**

**2.2. STABILIZATION REQUIREMENTS..... 19**

**2.3. POLLUTION PREVENTION REQUIREMENTS..... 23**

**3. WATER QUALITY-BASED EFFLUENT LIMITATIONS..... 29**

**3.1. GENERAL EFFLUENT LIMITATION TO MEET APPLICABLE WATER QUALITY STANDARDS..... 29**

**3.2. DISCHARGE LIMITATIONS FOR IMPAIRED WATERS..... 29**

**3.3. DISCHARGES TO WATERS IDENTIFIED AS CATEGORY 1 or 2..... 30**

**4. INSPECTIONS..... 31**

**4.1. SITE INSPECTIONS..... 31**

**4.2. INSPECTIONS BY DWQ OR MS4 OF JURISDICTION..... 35**

**5. CORRECTIVE ACTIONS..... 37**

**5.1. “CORRECTIVE ACTIONS” DEFINED..... 37**

**5.2. REQUIREMENTS FOR TAKING CORRECTIVE ACTION..... 37**

**5.3. CORRECTIVE ACTION REQUIRED BY DWQ..... 37**

**5.4. CORRECTIVE ACTION REPORT..... 37**

**6. STAFF TRAINING REQUIREMENTS..... 39**

**7. STORM WATER POLLUTION PREVENTION PLAN (SWPPP)..... 40**

**7.1. GENERAL REQUIREMENTS..... 40**

**7.2. SWPPP CONTENTS..... 40**

**7.3. ON-SITE AVAILABILITY OF YOUR SWPPP..... 47**

**7.4. REQUIRED SWPPP MODIFICATIONS..... 48**

**8. HOW TO TERMINATE COVERAGE..... 50**

**8.1. MINIMUM INFORMATION REQUIRED IN NOT..... 50**

**8.2. CONDITIONS FOR TERMINATING PERMIT COVERAGE..... 51**

**8.3. FINAL INSPECTION ASSOCIATED WITH TERMINATION..... 52**

**8.4. HOW TO SUBMIT YOUR NOT..... 52**

**8.5. DEADLINE FOR SUBMITTING NOTS..... 52**

**8.6. EFFECTIVE DATE OF TERMINATION OF COVERAGE..... 52**

Appendix A – Definitions and Acronyms

Appendix B – Small Construction Waivers and Instructions

Appendix C – List with Information on Utah’s Waters

Appendix D – Buffer Guidance

Appendix E – List of MS4s with Municipal Storm Water Permits

Appendix F – 2 Year, 24 Hour Storm Frequencies in Utah and Average Annual Rainfall in Utah

Appendix G – Standard Permit Conditions

Appendix H – Notice of Intent Form (NOI)

Appendix I – Notice of Termination (NOT)



Appendix J – Visual Monitoring Form

Appendix K – Erosivity Waiver Form

Appendix L – Example Self-Inspection Form

Appendix M – Notice for New Owner/General Contractor Operations

**1. HOW TO OBTAIN PERMIT COVERAGE UNDER THE UTAH CGP.**

To be covered under this permit, you must meet the eligibility conditions and follow the requirements for applying for permit coverage in this Part.

Discharges referred to in this permit are discharges that are typical to construction activity, as described in the following section, that outfall to a surface water in the State of Utah. Typical discharges associated with construction activity present a risk of contaminants for soil, sediment, silt, including soil nutrients (phosphorus and possibly nitrogen), and including chemical pollutants (chemicals in the construction process, and/or oils/grease/fuels). The focus of the EPA and DWQ for the most part is risk of pollution to surface waters.

Construction activity that presents risks of fuel and other normal quantities and types of construction chemicals present a risk of pollution of surface and groundwaters.

Construction activity that presents risks of quantities and types of chemicals that are not normal to typical construction activity may need to pursue permit coverage under an individual UPDES permit.

If storm water is contained on the site (coupled with a rational containment plan with calculations to back it up) no permit is necessary because there will be no discharge from the site, excluding those sites that present a risk to groundwater as said above.

**1.1. ELIGIBILITY CONDITIONS REQUIRED OF ALL PROJECTS.**

Only those parties and projects that meet all of the following eligibility conditions may be covered under this permit:

1.1.1. Parties that must sign the NOI are the parties shown below that are involved with construction activity on a construction project.

- a. Owner: The party that owns/leases the land on which the construction activities occur and has ultimate control over the project and the destiny of a project. The owner has control over construction plans and specifications, including the ability to make modifications at the highest level, to those plans and specifications.
- b. Operator: The party (usually the general contractor) that has day-to-day operational control of those activities at a project that are necessary to ensure compliance with the permit conditions (e.g., they are authorized to direct workers at a site to carry out activities required by the permit).

*Note: In the case of land development there may be sub-projects (such as construction of a house in a residential development) associated with the main project. In the case that the parcel of land for the subordinate project is sold to another owner, it must be covered under a separate permit and cannot be covered under the same permit for the development. If the developer is the owner of the development and owner of houses being built in the development (this would be for a house(s) built for speculation unless the prospective owner of the house has not secured ownership yet), the house building may continue to be covered under the original development permit provided the SWPPP for the main project covers the details concerning the activities of the subordinate project.*

Note: *Only one NOI permit application can provide coverage for one area under one owner and one operator. If a development gets to the point where lots are sold and another party(ies) takes over control and ownership on sub-project(s) in the development, a new permit must cover the area for the new owner. The developer's original permit can no longer cover that area and the original owner/developer must submit a partial NOT for the area that is sold.*

- c. **Operators must provide information, coordination, and/or contract obligations** so that all parties involved in the project perform by SWPPP (see Part 7.) and permit requirements.

1.1.2. The Project:

- a. A project covered by this permit will **disturb 1 or more acres of land**, or will disturb less than 1 acre of land but be part of a **common plan** of development or sale that will ultimately disturb 1 or more acres of land; or
- b. **A project's discharges have been designated** by the Executive Secretary as needing a permit under UAC 317-8-3.9(1)(a)5. or UAC 317-8-3.9(6)(e)2.;

1.1.3. A project is **located within the state of Utah**, except for Indian Country (Storm water permits for Indian Country within the State must be acquired through EPA Region VIII, except for facilities on the Navajo Reservation or on the Goshute Reservation which must acquire storm water permits through EPA Region IX);

1.1.4. **Discharges** from a project area **cannot**;

- a. **already have coverage under** the UPDES CGP or an individual storm water permit for construction activity; or

Note: *There can be another UPDES wastewater permit for wastewater generated at the site in a discharge separate from the storm water discharge, and/or other industrial storm water permit coverage for industrial storm water discharged at the site. There cannot be double coverage under this CGP for the same area for construction activity.*

- b. **be in the process of having coverage** under a different UPDES permit for a storm water (from construction activities) discharge denied, terminated, or revoked.<sup>1,2</sup>

1.1.5. *Endangered Species Act (ESA)*: This permit does not diminish from or alter in any way a permittees responsibility under the ESA. It is the permittees responsibility to comply with the ESA as it pertains to your project's construction activities. There are no requirements in this permit concerning the ESA.

---

<sup>1</sup> Parts 1.1.4.a. and 1.1.4.b. do not include sites currently covered under UTR100000 or UTR300000, which are in the process of obtaining coverage under this permit, and sites covered under this permit which are transferring coverage to a different operator.

<sup>2</sup> Notwithstanding a project being made ineligible for coverage under this permit because it falls under the description of Parts 1.1.4.a or 1.1.4.b, above, DWQ may waive the applicable requirement after specific review if it determines that coverage under this permit is appropriate.

1.1.6. *National Historic Preservation Act (NHPA):*

The permit does not diminish from or alter in any way a permittees responsibility under the NHPA. It is the permittees responsibility to comply with the NHPA as it pertains to your project's construction activities. There are no requirements in this permit concerning the NHPA.

1.2. **ELIGIBILITY CONDITIONS THAT APPLY DEPENDING ON TYPE OF PROJECT.** The following conditions (Parts 1.2.1 through 1.2.4), if applicable, must also be satisfied in order to obtain coverage under this permit.

1.2.1. **Eligibility for Emergency-Related Construction Activities.** If you are conducting earth-disturbing activities in response to a public emergency (e.g., natural disaster, widespread disruption in essential public services), and the related work requires immediate authorization to avoid imminent endangerment to human health, public safety, or the environment, or to reestablish essential public services, your requirements are:

- a. If the emergency related activity is accomplished within 30-days you are waived from the normal requirements to submit an NOI and prepare a SWPPP, but you must submit a report to DWQ within 45-days and show:
  - i. the nature of the emergency work performed,
  - ii. a description of earth disturbances that occurred,
  - iii. the proximity of the work to waters of the US, and what was done (if anything) to protect water quality during the emergency work, and
  - iv. the occurrence of the public emergency must be substantiated.
- b. If the emergency activity continues longer than 30-days you are authorized to discharge on the condition that a complete and accurate NOI is submitted within 30 calendar days after commencing earth-disturbing activities establishing that you are eligible under this permit. You are also required to provide documentation in your SWPPP to substantiate the occurrence of the public emergency (see 7.2.3.).

1.2.2. **Water Quality Standards – Eligibility for New Sources.** If you are a “new source” (as defined in Appendix A), you are not eligible for coverage under this permit for discharges that have the reasonable potential to cause, or contribute to an excursion above any applicable water quality standard. Where such a determination is made, DWQ may notify you that an individual permit application is necessary in accordance with Part 1.4.5. However, your coverage under this permit will be acceptable if you have included appropriate controls and implementation procedures designed to bring your discharge into compliance with water quality standards. In the absence of information demonstrating otherwise, DWQ expects that compliance with the storm water control requirements of this permit, including the requirements applicable to such discharges in Part 3.2, will result in discharges that will not cause, have the reasonable potential to cause, or contribute to an excursion above any applicable water quality standard.

- 1.2.3. **Discharging to Waters with High Water Quality – Eligibility for New Sources.** If you are a “new source” (as defined in Appendix A), you are eligible to discharge to a Category 1 water if your discharge is temporary and limited and where best management practices will be employed to minimize pollution effects, to a Category 2 water only if your discharge will not lower the water quality of the applicable water. In the absence of information demonstrating otherwise, DWQ expects that compliance with the storm water control requirements of this permit, including the requirements applicable to such discharges in Part 3.3.2, will result in discharges that will not lower the water quality of the applicable water. Please refer to Appendix C or look up your receiving waters for water quality information at <http://wq.deq.utah.gov/>.

**Note:** *Your project will be considered to discharge to a Category 1 or 2 water if the first surface water to which you discharge is identified by the state as a Category 1 or 2 water. For discharges that enter a storm sewer system prior to discharge, the first surface water to which you discharge is the water body that receives the storm water discharge from the storm sewer system.*

- 1.2.4. **Use of Cationic Treatment Chemicals.** If you plan to use cationic treatment chemicals (as defined in Appendix A), you are ineligible for coverage under this permit, unless you notify DWQ in advance and DWQ authorizes coverage under this permit (in writing) after you have included appropriate controls and implementation procedures designed to ensure that your use of cationic treatment chemicals will not lead to an impairment of the natural life cycle of any aquatic organism downstream.

1.3. **TYPES OF DISCHARGES AUTHORIZED UNDER THIS PERMIT.**

The following is a list of discharges that are allowed under this permit provided that appropriate storm water controls are designed, installed, and maintained:

- 1.3.1. **Storm water discharges**, including storm water runoff, snowmelt runoff, and surface runoff and drainage, associated with construction activity under UAC R317-8-3.9(6)(d)10. or UAC R317-8-3.9(6)(e)1.;
- 1.3.2. Storm water **discharges designated** by DWQ as needing a permit under UAC R317-8-3.9(1)(a)5 or UAC R317-8-3.9(6)(e)2;
- 1.3.3. Storm water discharges from **construction support activities** (e.g., concrete or asphalt batch plants, equipment staging yards, material storage areas, excavated material disposal areas, borrow areas) provided:
- The support activity is directly related to the construction site required to have permit coverage for storm water discharges;
  - The support activity does not serve multiple unrelated construction projects;
  - The support activity does not continue to operate beyond the completion of the construction activity at the project it supports; and
  - Storm water controls are implemented in accordance with Part 2 and, if applicable, Part 3, for discharges from the support activity areas.

- 1.3.4. **The following non-storm water discharges** from your construction activity are **allowed** under this permit, provided that you comply with all applicable requirements for these discharges in Part 2:
- a. Discharges from emergency fire-fighting activities;
  - b. Fire hydrant flushings;
  - c. Properly managed landscape irrigation;
  - d. Water used to wash vehicles and equipment, provided that there is no discharge of soaps, solvents, or detergents used for such purposes;
  - e. Water used to control dust;
  - f. Potable water including uncontaminated water line flushings;
  - g. Routine external building washdown that does not use detergents, or that have received chemicals to alter pH;
  - h. Pavement wash waters provided spills or leaks of toxic or hazardous materials have not occurred (unless all spill material has been removed) and where detergents (including Biodegradable soy bean oils and Biodegradable detergents) are not used. You are prohibited from directing pavement wash waters directly into any surface water, storm drain inlet, or storm water conveyance;
  - i. Uncontaminated air conditioning or compressor condensate;
  - j. Uncontaminated, non-turbid discharges of ground water (from natural sources) or spring water;
  - k. Foundation or footing drains where flows are not contaminated with process materials such as solvents, contaminated ground water, or sediment from construction activity; and

1.3.5. Discharges of storm water listed above in Parts 1.3.1, 1.3.2, and 1.3.3, or authorized non-storm water discharges in Part 1.3.4 above, commingled with a discharge authorized by a different UPDES permit and/or a discharge that does not require UPDES permit authorization.

- a. Construction dewatering must be permitted under UTG070000 (Construction Dewatering and Hydrostatic Test Permit), and the MS4 (of jurisdiction) notified of the discharge. It does not need to be permitted under UTG070000 if the construction dewatering does not leave the site (it is percolated into the ground at some place on the project site),

1.4. **SUBMITTING YOUR NOTICE OF INTENT (NOI) AND PERMIT FEE.**

Except for permittees with existing permit coverage (permittees with existing coverage from a CGP that was issued earlier and that has now expired just prior to the issuance of

this permit, who are automatically covered under this permit see 1.4.3.), to be covered under this permit, you must submit to DWQ a complete and accurate NOI and the permit fee prior to commencing construction activity. The permit fee is a yearly fee. To remain covered under the permit the permit fee must be submitted again once every year on the yearly anniversary of the submission date of the NOI along with a permit fee until the project is completed.

The NOI certifies to DWQ that you are eligible for coverage according to Part 1.1 and 1.2, and provides information about your construction operation and discharge.

There is one exception to the requirement. It is for an emergency-related project. For this type of project, the NOI must be submitted within 30 calendar days after the commencement of earth disturbing activities (see Part 1.2.1).

In every case a **Storm Water Pollution Prevention Plan (SWPPP)** consistent with Part 7 **must be completed prior to submitting your NOI** for coverage under this permit. Failure to develop a SWPPP and or have a sufficient SWPPP on site can result in fines and or work stoppages.

All NOI applications and project storm water compliance plans must be coordinated with storm water regulated MS4s (municipalities with storm water jurisdiction that are regulated with a municipal storm water permit, see the list of regulated MS4s in Appendix E). MS4s that are regulated under a municipal storm water permit are required to oversee construction activity on disturbances over an acre (or less than an acre if part of a common plan of development that is over an acre) within their jurisdiction. Utah DWQ directly reviews and inspects permittees in all other areas of Utah (except "Indian country").

1.4.1. **How to Submit Your NOI.** NOIs must be entered on DEQ's electronic NOI and storm water system. This can be done on <https://secure.utah.gov/stormwater>. If you do not have access to the internet or are having continual problems with the use of the NOI (CGP permit application) system, contact the DWQ Office at 801-536-4300, and submit a hard copy of the NOI form which can be found on the DWQ construction storm water web site (<http://www.waterquality.utah.gov/UPDES/stormwatercon.htm> -- see footnote 3 next page). DWQ advises that at some point you create an account for the on-line storm water permit data base so that you can track your permit and have the options to renew and/or terminate your permit (actions that should be done on-line).

1.4.2. **Start and End of Permit Coverage and Deadlines.** Except for projects initiated for emergency situations (for which either the NOI requirement is waived or the NOI must be submitted within 30-days after the commencement of soil disturbing activities, see paragraph 1.2.1), the construction storm water permit must be obtained before soil disturbing activities can begin on a construction site. This permit will officially cover construction activity on a project site immediately after the NOI has been successfully entered into the storm water data base,<sup>3</sup> and the

---

<sup>3</sup> All storm water NOIs are electronically entered into the SW data base. The vast majority are entered electronically by permittees in the on-line application process. For cases where a permittee is not able to electronically enter an NOI the permittee must submitted a paper form of the NOI to DWQ where it will be entered electronically by DWQ staff.

permit fee is paid. Coverage will remain active contingent on all of the following conditions:

- a. The permittee purposely terminates the permit:
  - i. a notice of termination (NOT) is submitted electronically (preferably) or in paper form to DWQ.
  - ii. where the permitted site is within a regulated MS4 jurisdiction (see Appendix E) the permittee must contact the local MS4 to inform that the project is completed and request a final inspection,

Note: *Termination of the project is not complete without approval through a final inspection.*

- b. the yearly permit fee is kept current and renewed year by year for the period of construction activity,
- c. when this general permit (UTRC00000) expires it is assumed at this point that coverages will automatically transfer to a succeeding permit, but if not the permittee will have to apply for continued coverage under a new or reissued replacement permit,
- d. coverage under the CGP is rescinded or revoked for the project site for administrative reasons for which the permittee will be notified in writing, or
- e. in the case, if or when all storm water discharges for the site are permitted under a different general or individual UPDES permit. For which case this permit is terminated on the day the other permit coverage begins.

1.4.3. **Exception to NOI Deadline for “Existing Permits”.** Existing permits are construction activities with soil disturbances which require coverage under a UPDES construction storm water permit, and which projects had active and legitimate coverage under UTR300000 at the time of expiration of that general permit, or that received coverage before this permit was issued. Existing projects are automatically “covered” under this permit. The same permit tracking number given under UPDES general storm water permit UTR300000 will continue to identify permit coverage for an existing project under this permit. **Existing projects have 6 months** from the issuance date of this permit to update site storm water controls and the site SWPPP to meet requirements in this permit.

1.4.4. **Continuation of Coverage for ‘Existing Permits’ After this Permit Expires.** If this permit is not reissued or replaced by the expiration date of the general permit, it will be administratively extended by the Director and remain in force and effect until issuance of a comparable CGP replacement. Permit coverage will continue under this permit until the earliest of:

- a. authorization of, and an application process, is provided for coverage under a reissued or replacement version of this permit; or
- b. the permittee’s submittal of a Notice of Termination; or



- c. the issuance of an individual permit or denial of coverage (see part 1.4.5 below) for the project's discharges; or
- d. A final permit decision by DWQ not to reissue a general permit, at which time DWQ will identify a reasonable time period for covered dischargers to seek coverage under an alternative general permit or an individual permit. Coverage under this permit will terminate at the end of this time period.

DWQ reserves the right to modify or revoke and reissue this permit under UAC317-8-5.6, in which case you will be notified of any relevant changes or procedures to which you may be subject.

- 1.4.5. **Procedures for Denial of Coverage.** Following your submittal of a complete and accurate NOI, you may be notified in writing by DWQ that you are not covered, and that you must either apply for and/or obtain coverage under an individual UPDES permit or an alternate general UPDES permit. This notification will include a brief statement of the reasons for this decision and will provide application information. Any interested person may request that DWQ consider requiring an individual permit under this paragraph.

If you are already a permittee with coverage under this permit, the notice will set a deadline to file the permit application, and will include a statement that on the effective date of the individual UPDES permit or alternate general UPDES permit, as it applies to you, coverage under this general permit will terminate. DWQ may grant additional time to submit the application if requested. If you are covered under this permit and fail to submit an individual UPDES permit application or an NOI for an alternate general UPDES permit as required by DWQ, then the applicability of this permit to you is terminated at the end of the day specified by DWQ as the deadline for application submittal. DWQ may take appropriate enforcement action for any unpermitted discharge. If you submit a timely permit application, then when an individual UPDES permit is issued to you or you are provided with coverage under an alternate general UPDES permit, your coverage under this permit is terminated on the effective date of the individual permit or date of coverage under the alternate general permit.

- 1.5. **REQUIREMENT TO POST A NOTICE OF YOUR PERMIT COVERAGE.** You must post a sign or other notice conspicuously at a safe, publicly accessible location in close proximity to the project site. At a minimum, the notice must include the UPDES Permit tracking number and an operator contact name (or designee) and phone number and/or email address for obtaining additional UPDES permit, SWPPP, and/or project information. The notice must be located so that it is visible from a public access point that is nearest to the active part of the construction site, and it must use a font large enough to be readily viewed from a public right-of-way. The posted contact number must have a person available for response during business hours. An inquiry made to the posted email address must receive a response within 24-hours week days.

**2. EFFLUENT LIMITATIONS APPLICABLE TO ALL DISCHARGES FROM CONSTRUCTION SITES** (including support activities).

**Note:** *If your project is an “existing project” (see Part 1.4.3) or if you are a “new owner/operator of an existing project” (see Part 1.4.3), and it is infeasible for you to comply with a specific requirement in this Part because (1) the requirement was not part of the permit you were previously covered under (i.e., the 2003 or 2008 CGP), you are required to document this fact in your SWPPP and are waived from complying with that requirement. This flexibility applies only to the requirements in Parts 2.1, and 2.3.3 through 2.3.5 (except for Parts 2.3.3.a, 2.3.3.b.ii, 2.3.3.c.iii.1), and 2.3.3.d). This only applies to those portions of your site that have already commenced earth-disturbing activities or where storm water controls implemented in compliance with the previous permit have already been installed.*

This section includes the following types of requirements:

- Erosion and Sediment Control Requirements (Part 2.1)
- Stabilization Requirements (Part 2.2)
- Pollution Prevention Requirements (Part 2.3)

**2.1. EROSION AND SEDIMENT CONTROL REQUIREMENTS.**

Erosion and sediment controls must be designed, installed, and maintained to minimize the discharge of pollutants from earth-disturbing activities.

**2.1.1. General Requirements Applicable to All Construction Sites.**

- a. **Area of Disturbance.** You are required to minimize the amount of disturbed and exposed soil during construction activities.
- b. **Design Requirements.**

**Note:** *Although many aspects of developing a SWPPP do not require a P.E., there are significant portions or items required in the development of a SWPPP that makes it to where many if not all SWPPPs must include a P.E. in its development. It is not required for a P.E. to stamp the entire SWPPP because operators must have the flexibility to modify a SWPPP. There may be facilities in a SWPPP that need to be stamped and would require a review and to be re-stamped by a P.E. again if modifications occur. For the most part SWPPPs should be designed so that operators have the flexibility to make modifications and updates in the field as is necessary so that improvements can be made for the protection of disturbed soils and the quality of storm water runoff if SWPPP plans prove to be ineffective, or if the conditions at the site turn out to be different than expected. A P.E. knows what is not safe without a stamp.*

- i. Storm water controls must be installed to handle what is estimated as normally expected for the area including seasonal considerations. Considerations include storm water run-on and run-off, flow from impervious surfaces, slopes, infiltration potential, and site drainage features.
- ii. For temporary/permanent sediment basins and channelized flows design must consider the following factors for storm water controls.
  - 1) expected frequency, intensity, and duration of precipitation;

- 2) peak flowrates and total storm water volume to minimize downstream channel and streambank erosion in the immediate vicinity of the discharge points; and
  - 3) the range of soil particle sizes expected to be present on the site.
- iii. The permittee must **preserve naturally vegetated areas where possible** and if feasible use these areas to maximize infiltration and to reduce pollutant discharges. The use of velocity dissipation devices may be necessary to prevent erosion.

c. **Installation Requirements.**

- i. Unless infeasible **storm water controls must be installed before commencing each phase of earth-disturbance** (e.g., buffers or equivalent sediment controls, perimeter controls, exit point controls, storm drain inlet protection) that control discharges from the initial site clearing, grading, and excavating.

**Note:** *Where it is infeasible to install storm water controls prior to the beginning of earth disturbing activities such controls must be installed immediately following the initial earth disturbance.*

- ii. **All storm water controls must be installed in accordance with good engineering and construction practices and manufacturer's specifications** including applicable design specifications.

**Note:** *Design specifications may be found in manufacturer specifications and/or in applicable erosion and sediment control manuals or ordinances. Any departures from such specifications must reflect good engineering practice, good construction practices and must be explained in your SWPPP.*

d. **Maintenance Requirements.**

- i. All erosion and sediment controls required in this Part must remain in effective operating condition during permit coverage and be protected from activities that would reduce their effectiveness.
- ii. All erosion and sediment controls must be inspected in accordance with the applicable requirements in Part 4.1, For problems discovered during inspections replacement, repairs, or maintenance must be done immediately following the inspection or in a timely manner as identified in the SWPPP. The permittee must maintain all preserved vegetation, erosion and sediment control measures and other protective measures identified in the SWPPP in effective operating condition for all precipitation events, or before if required by DWQ or MS4 oversight inspectors. . If maintenance prior to the next anticipated storm event is impracticable, maintenance must be scheduled and accomplished as soon as practicable.
- iii. Maintenance needs identified by means other than inspections shall be accomplished before the next anticipated storm event, or as necessary to

maintain the continued effectiveness of storm water controls. A description of procedures to ensure the timely maintenance of these measures shall be identified in the SWPPP.

**2.1.2. Erosion and Sediment Control Requirements Applicable to All Sites.**

- a. **Natural Buffers or Equivalent Sediment Controls.** (These requirements only apply when a surface water is located within 50 feet of your project's earth disturbances, and in the case of intermittent waters, only to surface waters that have visible water flowing or that typically flow continuously more than two months out of the year).

**Note:** *Areas that you do not own or that are otherwise outside your operational control may be considered areas of undisturbed natural buffer for purposes of compliance with this part.*

You must ensure that any discharges to surface waters through the area between the disturbed portions of the property and any surface waters located within 50 feet of your site are treated by an area of undisturbed natural buffer and/or additional erosion and sediment controls in order to achieve a reduction in sediment load equivalent to that achieved by a 50-foot natural buffer. Refer to Appendix D (Buffer Guidance) for information to assist you in complying with this requirement, and to Part 2.1.2.a.v. for exceptions to this requirement.

- i. **Compliance Alternatives.** You can comply with this requirement in one of the following ways:
- 1) Provide and maintain a 50-foot undisturbed natural buffer; or

**Note:** *If your earth disturbances are located 50 feet or further from a surface water, then you have complied with this alternative.*

- 2) Provide and maintain an undisturbed natural buffer that is less than 50 feet that is supplemented by additional erosion and sediment controls, which in combination achieves the sediment load reduction equivalent to a 50-foot undisturbed natural buffer (see Appendix D); or
- 3) If it is infeasible to provide and maintain an undisturbed natural buffer of any size, you must implement erosion and sediment controls that achieve the sediment load reduction equivalent to a 50-foot undisturbed natural buffer (see Appendix D).

**Note:** *For the compliance alternatives in Parts 2.1.2.a.i.1) and 2.1.2.a.i.2), you are not required to enhance the quality of the vegetation that already exists in the buffer, or provide vegetation if none exists (e.g., arid and semi-arid areas). You only need to retain and protect from disturbance the natural buffer that existed prior to the commencement of construction. Any preexisting structures or impervious surfaces are allowed in the natural buffer provided you retain and protect from disturbance the natural buffer area outside the preexisting disturbance. Similarly, for alternatives 2.1.2.a.i.2) and 2.1.2.a.i.3), you are required to implement and maintain sediment controls that achieve the sediment load reduction equivalent to the undisturbed natural buffer*

*that existed on the site prior to the commencement of construction. In determining equivalent sediment load reductions, you may consider naturally non-vegetated areas and prior disturbances. See Appendix D for a discussion of how to determine equivalent reductions.*

You must document the compliance alternative you have selected in your SWPPP, and comply with the applicable additional requirements described in Parts 2.1.2.a.ii. below.

The compliance alternative selected above must be maintained throughout the duration of permit coverage, unless you select a different compliance alternative during your period of permit coverage, in which case you must modify your SWPPP to reflect this change.

- ii. **Additional Requirements for the Compliance Alternatives in Parts 2.1.2.a.i.1) and 2.1.2.a.i.2).** If you choose either of the compliance alternatives in Parts 2.1.2.a.i.1) or 2.1.2.a.i.2) above, throughout your period of coverage under this permit, you must comply with the following additional requirements:
  - 1) Where there is a concentrated storm water discharge leaving the site's disturbed area and crossing the natural buffer area (whether the buffer area is a full 50 feet (2.1.2.a.i.1) or less than 50 feet with additional BMPs (2.1.2.a.i.2)), the concentrated flow must have treatment or BMPs to minimize sediment transport, found in the area generating the flow and not just as it crosses the buffer area. Additionally, velocity dissipation devices must be used where erosion is caused by the flow as it crosses the buffer area;
  - 2) Document in your SWPPP the natural buffer width retained on the property, and show the buffer boundary on your site plan; and;
  - 3) Delineate, and clearly mark off, with flags, tape, or other similar marking device all natural buffer areas.
- iii. **Additional Requirements for the Compliance Alternatives in Parts 2.1.2.a.i.2) and 2.1.2.a.i.3).** For compliance alternatives in Parts 2.1.2.a.i.2) and 2.1.2.a.i.3), you must document in your SWPPP the erosion and sediment control(s) you will use to achieve an equivalent sediment reduction, and any information you relied upon to demonstrate the equivalency.
- iv. **Additional Requirement for the Compliance Alternative in Part 2.1.2.a.i.3).** For compliance alternative in Part 2.1.2.a.i.3), you must also include in your SWPPP a description of why it is infeasible for you to provide and maintain an undisturbed natural buffer of any size.
- v. **Exceptions.**
  - 1) If there is no discharge of storm water to surface waters through the area between your site and any surface waters located within 50 feet of your site, you are not required to comply with the requirements in this Part.

This includes situations where you have implemented control measures such as a berm or other barrier that will prevent such discharges.

- 2) Where no natural buffer exists due to preexisting development disturbances (e.g., structures, impervious surfaces) that occurred prior to the initiation of planning for the current development of the site, you are not required to comply with the requirements in this Part, unless you will remove portions of the preexisting development.

Where some natural buffer exists but portions of the area within 50 feet of the surface water are occupied by preexisting development disturbances, you are required to comply with the requirements in this Part. For the purposes of calculating the sediment load reduction for either Part 2.1.2.a.i.2) or 2.1.2.a.i.3) above, you are not expected to compensate for the reduction in buffer function from the area covered by these preexisting disturbances. See Appendix D for further information about compliance alternatives in Part 2.1.2.a.i.2) or 2.1.2.a.i.3) above.

If during your project, you will disturb any portion of these preexisting disturbances, the area disturbed will be deducted from the area treated as natural buffer.

- 3) For “linear construction projects” (see Appendix A for a definition), you are not required to comply with the requirements in this Part if site constraints (e.g., limited right-of-way) prevent you from meeting any of the compliance alternatives in Part 2.1.2.a.i, provided that, to the extent practicable, you limit disturbances within 50 feet of the surface water and/or you provide supplemental erosion and sediment controls to treat storm water discharges from earth disturbances within 50 feet of the surface water. You must also document in your SWPPP your rationale as to why it is infeasible for you to comply with the requirements in Part 2.1.2.a.i, and describe any buffer width retained and/or supplemental erosion and sediment controls installed.
- 4) For “small residential lot” construction (i.e., a lot being developed for residential purposes that will disturb less than 1 acre of land, but is part of a common plan of development or sale that will ultimately disturb greater than or equal to 1 acre), you have the option of complying with the requirements in Appendix D, Part D.2.3.
- 5) The following disturbances within 50 feet of a surface water are exempt from the requirements in this Part:
  - Construction approved under a CWA Section 404 permit; or
  - Construction of a water-dependent structure or water access area (e.g., pier, boat ramp, trail).

You must document in your SWPPP if any of the above disturbances will occur within the buffer area on your site.

**b. Perimeter Controls.**

- i. **Installation Requirements:** You must install sediment controls along those perimeter areas of your site that will receive storm water from areas where earth disturbing activities are occurring<sup>4</sup> **For linear projects** with rights-of-way that restrict or prevent the use of such perimeter controls, you must maximize the use of these controls where practicable and document in your SWPPP why it is impracticable in other areas of the project.
  - ii. **Maintenance Requirements:** You must remove sediment before it has accumulated to the point where storm water controls becomes ineffective. Often that is one-half of the above-ground height of any perimeter control. The permittee must follow maintenance specifications for the BMP used.
- c. **Sediment Track-Out.** You must minimize the track-out of sediment onto off-site streets, other paved areas, and sidewalks from vehicles exiting your construction site. To comply with this requirement, you must:
- i. Restrict vehicle use to properly designated exit points;
  - ii. Use appropriate stabilization techniques<sup>5</sup> at all points that exit onto paved roads so that sediment removal occurs prior to vehicle exit;
  - iii. Where necessary, use additional controls<sup>6</sup> to remove sediment from vehicle tires prior to exit; and
  - iv. Where sediment has been tracked-out from your site onto the surface of off-site streets, other paved areas, and sidewalks, you must remove deposited sediment before it accumulates significantly and is tracked beyond the immediate vicinity of the project (that may be several times a day or once a week, whatever is required to control off site tracking). You must remove the track-out by sweeping, shoveling, or vacuuming these surfaces, or by using other similarly effective means of sediment removal. You are prohibited from hosing or sweeping tracked out sediment into any storm water conveyance, storm drain inlet, or surface water.

**Note:** *DWQ recognizes that some fine grains may remain visible on the surfaces of off-site streets, other paved areas, and sidewalks even after you have implemented sediment removal practices. Such "staining" is not a violation of Part 2.1.2.c.*

- d. **Control Discharges from Stockpiled Sediment or Soil.** For any stockpiles or land clearing debris composed, in whole or in part, of sediment or soil

---

<sup>4</sup> Examples of perimeter controls include, but are not limited to, natural buffer zones (on the site or off); vegetative filter strips; silt fences; filter berms such as staked or weighted straw wattles, other wattles (sand, gravel, or those that are of a proprietary design); and temporary diversion dikes.

<sup>5</sup> Examples of appropriate stabilization techniques include the use of aggregate stone with an underlying geotextile or non-woven filter fabric, or turf mats.

<sup>6</sup> Examples of additional controls to remove sediment from vehicle tires include, but are not limited to, wheel washing, rumble strips, and rattle plates.

**Note:** For the purposes of this permit, sediment or soil stockpiles are defined as the storage for multiple days of soil or other sediment material to be used in the construction project. If a sediment or soil pile is used within a short period of time (e.g., a day or three days especially during dry days), it does not fall under the requirements of this part.

You must comply with the following requirements:

- i. Stockpiles must be located outside of any natural buffers established under Part 2.1.2.a.i and physically separated from other storm water controls (such as perimeter controls or inlet protection) implemented in accordance with Part 2.1, but must be contained within the BMP protected area of the site;
- ii. Protect from contact with storm water (including run-on) using a temporary perimeter sediment barrier;<sup>7</sup>
- iii. Where practicable, provide cover or appropriate temporary stabilization to avoid direct contact with precipitation or to minimize sediment discharge;

**Note:** For 2.1.2.d.iii. the objective is to minimize sediment discharge, the best BMP is to cover the pile; the second best BMP is to stabilize the surface of the pile, the third best is to set filter berms, silt fence, or equivalent around the bottom of the pile, maybe there should be 2 of the 3 suggested BMPs applied. The degree of effort must be commensurate to the risk of sediment loss that could affect water quality.

- iv. Do not hose down or sweep soil or sediment accumulated on pavement or other impervious surfaces into any storm water conveyance, storm drain inlet, or surface water; and
  - v. Where practicable, contain and securely protect from wind.
- e. **Minimize Dust.** In order to avoid pollutants from being discharged into surface waters you must minimize the generation of dust through the appropriate application of water or other dust suppression techniques (as required in your air quality permit for those that are required to have air quality permits).
- i. **Minimize the Disturbance of Steep Slopes.** You must minimize the disturbance of “steep slopes” (see definition in Appendix A).

**Note:** The permit does not prevent or prohibit disturbance on steep slopes. For some projects, disturbance on steep slopes may be necessary for construction (e.g., a road cut in mountainous terrain). If a disturbance to steep slopes is required for the project, DWQ would recognize that it is not economically achievable to avoid the disturbance to steep slopes. However, in cases where steep slope disturbances are required, minimizing the disturbances to steep slopes consistent with this requirement can be accomplished through the implementation of a number of standard erosion and sediment control practices, such as by phasing disturbances to these areas and using stabilization practices designed to be used on steep grades.

- f. **Preserve Topsoil.** You must preserve native topsoil on your site, unless infeasible. Preserving topsoil is not required where the intended function of a

---

<sup>7</sup>Examples include berms, dikes, fiber rolls, silt fences, sandbag, gravel bags, or straw bale.



specific area of the site dictates that the topsoil be removed, and/or that the finished surface will be stabilized by a means other than re-vegetation.

**Note:** *Some projects may be designed to be highly impervious after construction, and therefore little or no vegetation is intended to remain. In these cases, preserving topsoil at the site would not be feasible. Some sites may not have space to stockpile topsoil on site for later use, in which case, it may also not be feasible to preserve topsoil.*

**Note:** *Stockpiling of topsoil at off-site locations, or transfer of topsoil to other locations, is an example of a practice that is consistent with the requirements in this Part.*

- g. **Minimize Soil Compaction.** In areas of your site where final vegetative stabilization will occur or where infiltration practices will be installed, you must either (minimizing soil compaction is not required where the intended function of the specific area of the site dictates that it be compacted):
  - i. **Restrict vehicle / equipment use.** Restrict vehicle and equipment use in these locations to avoid soil compaction (except for equipment used for seeding or cat tracking); or
  - ii. **Use soil conditioning techniques.** Prior to seeding or planting areas of exposed soil that have been compacted, use techniques that loosen or condition the soils to support vegetative growth, if necessary and feasible.
- h. **Protect Storm Drain Inlets.** If you discharge to any storm drain inlet that carries storm water flow from disturbed areas of your site directly to a surface water, and you have authority to access the storm drain inlet, you must:
  - i. **Installation Requirements.** Install inlet protection measures<sup>8</sup> that remove sediment from your discharge prior to entry into the storm drain inlet.

**Note:** *Inlet protection measures can be removed in the event of flood conditions or to prevent erosion.*

- ii. **Maintenance Requirements.** Clean, or remove and replace, storm water protection measures as sediment accumulates, the filter becomes clogged, and/or performance is compromised. Inlet protection measures should be maintained in effective working conditions at all times, but particular attention must be given to prepare inlets for a forecasted precipitation event.
- i. **Areas of High Altitude/Heavy Snow Conditions.** You must attempt to prepare for the heavy snows by deploying storm water controls prior to the first heavy snow, and have appropriate storm water control measures designed to handle snow melt before heavy snows occur. Dates when snow is expected should be noted in the SWPPP and updated as construction commences into the snow season. Stabilization measures should be deployed at the same time (see Section 2.2.1.c.).

---

<sup>8</sup> Examples of inlet protection measures include fabric filters, sandbags, gravel with filter fabric and concrete block barriers, weighted fiber rolls, wattles of filter fabric filled with sand/gravel, and proprietary devices designed for inlet protection.

2.1.3. **Requirements Applicable Only to Sites Using These Specific Storm Water Controls.** You are required to comply with the following requirements if you will install any of the following storm water controls at your site:

- a. **Constructed Storm Water Conveyance Channels.** Design storm water conveyance channels to avoid unstabilized areas on the site and to reduce erosion, unless infeasible. Minimize erosion of channels and their embankments, outlets, adjacent streambanks, slopes, and downstream waters during discharge conditions through the use of erosion controls and velocity dissipation devices<sup>9</sup> within and along the length of any constructed storm water conveyance channel, and at any outlet to provide a non-erosive flow velocity.
- b. **Sediment Basins.** If you install a sediment basin, you must comply with the following:
  - i. **Design requirements:**
    - 1) Provide storage for either (1) the calculated volume of runoff from a 2-year, 24-hour storm (see Appendix F), or (2) 3,600 cubic feet per acre drained;
    - 2) When discharging from the sediment basin, utilize outlet structures that withdraw water from the surface in order to minimize the discharge of sediment and floatable pollutants, unless infeasible; (taking water from the top is warmer, so in a case where you have a TMDL or water sensitive to temperature it would be better to take it from the middle)

*Note: DWQ believes that the circumstances in which it is infeasible to design outlet structures in this manner are rare. Exceptions may include areas with extended cold weather, where surface outlets may not be feasible during certain time periods (although it is expected that they would be used during other periods). If you have determined that it is infeasible to meet this requirement, you must provide documentation in your SWPPP to support your determination.*

- 3) Prevent erosion of (1) the sediment basin using stabilization controls (e.g., erosion control blankets), and (2) the inlet and outlet using erosion controls and velocity dissipation devices; and
    - 4) Sediment basins must be situated outside of surface waters and any natural buffers established under Part 2.1.2.a.i, and must be designed to avoid collecting water from wetlands.
  - ii. **Maintenance requirements.** Keep basins in effective operating condition and remove accumulated sediment when the basin reaches ½ of the design capacity of the sediment basin.

---

<sup>9</sup>Examples of velocity dissipation devices include check dams, sediment traps, riprap, or grouted riprap at outlets. Although piped slope drains and geotextile reinforced channels do not control velocity they prevent erosion on slopes.

- c. **Use of Treatment Chemicals.** If you plan to use cationic polymers and/or flocculants you must have an approval letter from DWQ. Otherwise you must comply with the following minimum requirements:
- i. **Use conventional erosion and sediment controls prior to and after the application of treatment chemicals.** Use conventional erosion and sediment controls prior to chemical addition to ensure effective treatment. Chemicals may only be applied where treated storm water is directed to a sediment control (e.g., sediment basin, perimeter control) prior to discharge.
  - ii. **Select appropriate treatment chemicals.** Chemicals must be selected that are appropriately suited to the types of soils likely to be exposed during construction and discharged to locations where chemicals will be applied, and to the expected turbidity, pH, and flow rate of storm water flowing into the chemical treatment system or area. If you cannot ensure the appropriate dosage, DWQ will not approve the chemical use.
  - iii. **Minimize discharge risk from stored chemicals.** Store all treatment chemicals in leak-proof containers that are kept under storm-resistant cover and surrounded by secondary containment structures (e.g., spill berms, decks, spill containment pallets), or provide equivalent measures, designed and maintained to minimize the potential discharge of treatment chemicals in storm water or by any other means (e.g., storing chemicals in covered area or having a spill kit available on site).
  - iv. **Comply with local requirements.** Comply with relevant local requirements affecting the use of treatment chemicals.
  - v. **Use chemicals in accordance with good engineering practices and specifications of the chemical provider/supplier.** You must also use treatment chemicals and chemical treatment systems in accordance with good engineering practices, and with dosing specifications and sediment removal design specifications provided by the provider/supplier of the applicable chemicals, or document specific departures from these practices or specifications and how they reflect good engineering practice.
  - vi. **Ensure proper training.** Ensure that all persons who handle and use treatment chemicals at the construction site are provided with appropriate, product-specific training. Among other things, the training must cover proper dosing requirements.
  - vii. **Comply with additional requirements for the approved use of cationic chemicals.** If you have been authorized to use cationic chemicals at your site pursuant to Part 1.2.4, and the authorization is conditioned on your compliance with additional requirements necessary to ensure that the use of such chemicals will not impair the life cycle of aquatic organisms downstream.
  - viii. **Provide proper SWPPP documentation.** You must include documentation in your SWPPP consistent with Parts 7.2.5.h. and 7.2.9.b. on the specific

chemicals and chemical treatment systems you will use, and how you will comply with the requirements in this Part.

- d. **Dewatering Practices.** You are prohibited from discharging ground water (or any water, even storm water, see note), that is extracted from excavations, trenches, foundations, vaults, or other similar points of accumulation, unless such waters are covered by the Utah UPDES permit for Construction Dewatering/Hydrostatic Testing. No additional permit is required if the water extracted is allowed to percolate back into the ground or that is otherwise managed where it does not have a surface discharge from the site.

**Note:** *Water that is present at construction sites, whether it is ground water, storm water, or from where ever, if it is heavily soiled from contact with construction activity it must be covered under the Construction Dewatering/Hydrostatic Testing permit with a total suspended solids limit if it is to be discharged.*

## 2.2. STABILIZATION REQUIREMENTS.

You are required to stabilize exposed portions of your site for all areas with an annual precipitation of over 20 inches in accordance with the requirements of this Part. This Part also includes stabilization and/or other requirements for areas with 20 inches of rainfall per year or less.

**Note:** *For the purposes of this permit, "exposed portions of your site" means areas of exposed soil that are required to be stabilized. Note that DWQ does not expect that temporary or permanent stabilization measures be applied to areas that are intended to be left unvegetated or unstabilized following construction (e.g., dirt access roads, utility pole pads, areas being used for storage of vehicles, equipment, or materials). However, areas constructed for these kinds of uses should have a finished surface conditioned with placement of a sufficient layer of soil similar to road base (or another kind of structural type soil/gravel layer that is resistant to erosion), and no top soil or organic material, and with compaction (unless gravel is used) to minimize the potential for erosion.*

### 2.2.1. Deadlines for Initiating and Completing Stabilization for areas receiving an annual precipitation of more than 20 inches a year.

- a. **Deadline to Initiate Stabilization.** You must initiate soil stabilization measures within 14 days of whenever earth-disturbing activities have permanently or temporarily ceased on any portion of the site.

**Note:** *Earth-disturbing activities have permanently ceased when clearing and excavation within any area of your construction site that will not include permanent structures has been completed.*

**Note:** *For the purposes of this permit, DWQ will consider any of the following types of activities to constitute the initiation of stabilization:*

1. *prepping the soil for vegetative or non-vegetative stabilization;*
2. *applying mulch or other non-vegetative product to the exposed area;*
3. *seeding or planting the exposed area;*
4. *starting any of the activities in # 1 to # 3 on a portion of the area to be stabilized, but not on the entire area; and*
5. *finalizing arrangements to have a stabilization product fully installed in compliance with the applicable deadline for completing stabilization in Parts*

2.2.1.b.ii. *This list of examples is not exhaustive.*

- b. **Deadline to Complete Stabilization Activities.** Within 14 calendar days after the initiation of soil stabilization measures consistent with Part 2.2.1.a<sup>10</sup>, you are required to have completed:
  - i. For vegetative stabilization, all activities<sup>11</sup> necessary to initially seed or plant the area to be stabilized; and/or
  - ii. For non-vegetative stabilization, the installation or application of all such non-vegetative measures.

**Note:** *During the days (14 days before initiating the process of stabilization) that the permittee has to determine if a section of the project must be temporarily or permanently stabilized, there must be perimeter controls around the area to prevent sediment transport off the site until surface stabilization is in place.*

- c. **Stabilization Requirements for High Altitudes and Areas Receiving Heavy Snow.** You must attempt to prepare for the heavy snows by deploying stabilization measures on all disturbed areas prior to the first heavy snow, and have appropriate stabilization measures designed to handle snow melt before heavy snows occur. Dates when snow is expected should be noted in the SWPPP and updated as construction commences into the snow season. Stabilization measures should be deployed at the same time as other runoff controls in anticipation of snow (see Section 2.1.2.i.).

2.2.2. **Stabilization and/or other requirements for areas receiving an annual precipitation of 20 inches of rainfall a year or less (arid and semi-arid areas), drought areas, and areas with seasonally dry periods.**

- a. Within 14 calendar days of a temporary or permanent cessation of work in any portion of your site you must initiate installation of one of the following or equivalent. The intensity of the application must be commensurate with the conditions at the site (e.g. soil type, steepness of slopes, weather patterns and seasons, proximity to water body.). The goal is to arrest all sediment transport to within the boundaries of the site up to storms with intensities of ½ inch/hour or greater. The permittee must explain the strategy for stabilization in the SWPPP, and times when higher or lower intense BMPs will be placed and why:
  - i. Preparation for seeding and seeding or planting (which should be during a wetter season or with irrigation),

**Note:** *It would be good in arid and semi-arid areas to plan the installation of any irrigation system early in construction sequence so that seeding and planting efforts will be effective.*

---

<sup>10</sup> DWQ may determine, based on an inspection carried out under Part 4.2 and corrective actions required under Part 5.3, that the level of sediment discharge on the site makes it necessary to require a faster schedule for completing stabilization. For instance, if sediment discharges from an area of exposed soil that is required to be stabilized are compromising the performance of existing storm water controls, DWQ may require stabilization to correct this problem.

<sup>11</sup> For example, such activities might include, but are not limited to, soil conditioning, application of seed or sod, planting of seedlings or other vegetation, application of fertilizer, and, as deemed appropriate, watering.

**Note:** *The lists found in 2.2.2.a.ii, iii, iv, and v. is a guideline. It is not necessary to deploy exactly as prescribed, but whatever is deployed must be effective at minimizing erosion and sediment transport from the site.*

- ii. For steeper slopes – geotextile blankets staked as necessary with or without seeding (possibly with mulch under the blanket), fiber rolls staked on the contours every 10 ‘ (or less) apart with mulch applied to the surface between,
- iii. Shallower slopes (15% or less):
  - 1) Cat tracking over straw mulch (moist),
  - 2) surface roughening in loose soil or cat tracking (depending on soil, mulch may have to be applied) with fiber rolls staked not more than 15 feet apart on the contours, on very shallow slopes and less distance apart for steeper slopes, (add mulch on steep end),
  - 3) mulch, hydromulch, possibly with seed, with tackifier if needed,
- iv. Flat areas:
  - 1) At minimum, loosened soil, surface roughening with larger depression areas (surface roughening should provide many small depressions to collect storm water) to collect storm water, and with peripheral controls. The surface must be reworked if the soil becomes hardened or compacted.
- v. Storm water conveyances:
  - 1) piped slope drains, check dams, rip-rap, geotextile channel protection, or other velocity control and channel protection for all storm water conveyance must be deployed on a slope .

- b. Within 14 calendar days after the initiation of seeding/ planting, or for application of control measure to initiate surface stabilization on inactive areas of the site, you must complete all activities necessary to initially seed/ plant, stabilize, or control the area to protect from sediment transport<sup>12</sup>.

**2.2.3. Deadlines for sites discharging to sensitive waters.** For any portion of the site that discharges to a sediment or nutrient-impaired water (see Part 3.2) or to a water that is identified as Category 1 or 2 for antidegradation purposes (see Part 3.3), you are required to complete the stabilization activities specified in Parts 2.2.1. and/or 2.2.2.

---

<sup>12</sup> Seed germination in the arid and semi-arid areas of Utah generally occurs in spring. Germination can occur in early fall if a wet season (if the “monsoons” come – a weather pattern that brings moist air from the southwest late summer into fall). Late fall is a good time to plant for spring germination. Germination timing is dictated by altitude, latitude, and often by dryer or wetter weather patterns. The application of seed qualifies as stabilization, however to be effective, seeding (hence stabilization) should be delayed until the spring or fall, or where irrigation can be provided.

within 7 calendar days after the temporary or permanent cessation of earth-disturbing activities.

- 2.2.4. **Criteria for Stabilization.** To be considered adequately stabilized, you must meet the criteria below depending on the type of cover you are using, either vegetative or non-vegetative.

**Note:** *Stabilization requirements are more difficult the more arid the area. Re-vegetation from seed in arid areas can take more than 3 years to fully develop. This permit allows termination in arid areas even if final stabilization as defined in Appendix A is not met. The terms to do this are spelled out in 2.2.4.a.ii.*

a. **Vegetative Stabilization.**

**Note:** *Vegetative stabilization measures for all areas, but especially in arid and semi-arid areas, is very important. Practices such as preservation of topsoil, and the use of compatible indigenous fill/borrow material pays off. Good vegetative management such as preserving existing vegetation, protecting natural buffers, and minimizing grading will prove valuable when attempting to stabilize and terminate the site and it will leave a better product.*

- i. For all sites, except those located in arid and semi-arid areas (areas with 20 inches or less of precipitation) or on agricultural lands.
  - 1) If you are vegetatively stabilizing any exposed portion of your site through the use of seed or planted vegetation, you must provide established uniform vegetation (e.g., evenly distributed without large bare areas), which provides 70 percent or more of the vegetative cover that was provided by vegetation prior to commencing earth-disturbing activities. You should avoid the use of invasive species;
  - 2) For final stabilization, vegetative cover must be perennial; and
  - 3) Immediately after seeding or planting the area to be vegetatively stabilized, to the extent necessary to prevent erosion on the seeded or planted area, you must select, design, and install non-vegetative erosion controls that provide cover (e.g., mulch, rolled erosion control products) to the area while vegetation is becoming established. Surface roughening or cat tracking perpendicular to the slope may also be used as a non-vegetative measure that can be used with seeding, but must be monitored because it may be susceptible to erosion during heavier storm events.
- ii. For sites located in arid and semi-arid areas (20 inches of precipitation or less), or drought-stricken areas, as these terms are defined in Appendix A, you are considered to have completed final stabilization if both of the following criteria are met:
  - 1) You must attempt to reestablish a vegetative cover using topsoil (topsoil preserved from the site and/or with additional (preferably local) topsoil from offsite), mulch, fertilizer, and/or other methods with seeding and planting to establish a perennial vegetative cover (preferably of an

indigenous seed mix) equivalent to the natural background cover, by design, so that permanent stabilization is expected occur by 3 to 3 and a half years after the project is completed with average precipitation; and

- 2) In addition to seeding or planting the area to be vegetatively stabilized, you must have non-vegetative erosion controls designed and installed either for permanent placement or temporary placement (of which degradation and decomposition is expected to be complete leaving no litter) that provide cover or BMP controls that are selected and designed purposely for protecting the seed and surface from erosion as much as is possible without active maintenance until the natural stabilizing effect of vegetation is established.
  - iii. For sites located on land used for agriculture. Disturbed areas on land used for agricultural purposes (e.g., pipelines across crop or range land, staging areas for highway construction) that are restored to their preconstruction agricultural use are not subject to these final stabilization criteria. Areas disturbed that were not previously used for agricultural activities, and areas that are not being returned to preconstruction agricultural use, must meet the conditions for stabilization in this Part.
- b. **Non-Vegetative Stabilization.** If you are using non-vegetative controls to stabilize exposed portions of your site, or if you are using such controls to temporarily protect areas that are being vegetatively stabilized, you must provide effective non-vegetative cover<sup>13</sup> to stabilize any such exposed portions of your site.

### 2.3. POLLUTION PREVENTION REQUIREMENTS.

You are required to design, install, and maintain effective pollution prevention measures in order to prevent the discharge of pollutants. Consistent with this requirement, you must:

- Eliminate certain pollutant discharges from your site (see Part 2.3.1);
- Properly maintain all pollution prevention controls (see Part 2.3.2); and
- Comply with pollution prevention standards for pollutant-generating activities that occur at your site (see Part 2.3.3).

These requirements apply to all areas of your construction site and any and all support activities covered by this permit consistent with Part 1.3.3.

2.3.1. **Prohibited Discharges.** You are prohibited from discharging the following from your construction site (this list is not a comprehensive list of prohibited discharges but are listed to clarify that although they are common practices on construction sites they are unacceptable to have in a discharge):

- a. Wastewater from washout of concrete, (see Part 2.3.2.d);

---

<sup>13</sup> For temporary stabilization, examples of temporary non-vegetative stabilization methods include, but are not limited to, hydromulch, straw mulch that is crimped in by cat-tracking or netted and staked, and erosion control blankets. For final stabilization, examples of permanent nonvegetative stabilization methods include, but are not limited to, riprap, gravel, gabions, and geotextiles.



- b. Wastewater from washout and cleanout of stucco, paint, form release oils, curing compounds and other construction materials, (see Part 2.3.1.d);
- c. Fuels, oils, or other pollutants used in vehicle and equipment operation and maintenance;
- d. Soaps, solvents, or detergents used in vehicle and equipment washing; and
- e. Toxic or hazardous substances from a spill or other release.

**2.3.2. General Maintenance Requirements.**

- a. You must ensure that all pollution prevention controls installed in accordance with this Part remain in effective operating condition and are protected from activities that would reduce their effectiveness. You must inspect all pollutant-generating activities and pollution prevention controls in accordance with your inspection frequency requirements in Parts 4.1.2 or 3.2.2.a. to avoid situations that may result in leaks, spills, and other releases of pollutants in storm water discharges to receiving waters, and must document your findings in accordance with Part 4.1.7. If you find that controls need to be replaced, repaired, or maintained, you must make the necessary repairs or modifications in accordance with the following:
  - i. Initiate work to fix the problem immediately after discovering the problem, and complete such work by the close of the next work day, if the problem does not require significant repair or replacement, or if the problem can be corrected through routine maintenance.
  - ii. When installation of a new pollution prevention control or a significant repair is needed, you must install the new or modified control and make it operational, or complete the repair, by no later than 7 calendar days from the time of discovery, or as directed by the DWQ, MS4, or EPA oversight inspector. If it is infeasible to complete the installation or repair within 7 calendar days, you must document in your records why it is infeasible to complete the installation or repair within the 7 calendar day timeframe and document your schedule for installing the storm water control(s) and making it operational as soon as practicable after the 7 calendar day timeframe. Where these actions result in changes to any of the pollution prevention controls or procedures documented in your SWPPP, you must modify your SWPPP accordingly within 7 calendar days of completing this work.

**2.3.3. Pollution Prevention Standards.** You are required to comply with the pollution prevention standards in this Part if you conduct any of the following activities at your site or at any construction support activity areas covered by this permit (see Part 1.3.3):

- Fueling and maintenance of equipment or vehicles;
- Washing of equipment and vehicles;
- Storage, handling, and disposal of construction materials, products, and wastes; and
- Washing of applicators and containers used for paint, concrete, or other materials.

**The pollution prevention standards are as follows:**

- a. **Fueling and Maintenance of Equipment or Vehicles.** If you conduct fueling and/or maintenance of equipment or vehicles at your site, you must provide an effective means of eliminating the discharge of spilled or leaked chemicals, including fuel, from the area where these activities will take place.<sup>14</sup>

To **comply** with the prohibition in Part 2.3.1.c, you must:

- i. If applicable, comply with the Spill Prevention Control and Countermeasures (SPCC) requirements in 40 CFR 112 and Section 311 of the CWA.
- ii. Ensure adequate supplies are available at all times to handle spills, leaks, and disposal of used liquids;
- iii. Use drip pans and absorbents under or around leaky vehicles;
- iv. Dispose of or recycle oil and oily wastes in accordance with other federal, state, tribal, or local requirements;
- v. Clean up spills or contaminated surfaces immediately, using dry clean up measures where possible, and eliminate the source of the spill to prevent a discharge or a furtherance of an ongoing discharge; and
- vi. Do not clean surfaces by hosing the area down.

- b. **Washing of Equipment and Vehicles.**

- i. You must provide an effective means of minimizing the discharge of pollutants from equipment and vehicle washing, wheel wash water, and other types of washing;<sup>15</sup> and
- ii. To comply with the prohibition in Part 2.3.1.d, for storage of soaps, detergents, or solvents, you must provide either (1) cover (e.g., plastic sheeting or temporary roofs) to prevent these detergents from coming into contact with rainwater, or (2) a similarly effective means designed to prevent the discharge of pollutants from these areas (such as tightly closed containers).

- c. **Storage, Handling, and Disposal of Construction Products, Materials, and Wastes.** You must minimize the exposure to storm water of any of the products,

---

<sup>14</sup>Examples of effective controls include, but are not limited to, locating activities away from surface waters and storm water inlets or conveyances, providing secondary containment (e.g., spill berms, decks, spill containment pallets) and cover where appropriate, and/or having spill kits readily available.

<sup>15</sup> Examples of effective controls include, but are not limited to, locating activities away from surface waters and storm water inlets or conveyances and directing wash waters to a sediment basin or sediment trap, using filtration devices, such as filter bags or sand filters, or using other similarly effective controls.

materials, or wastes specified below that are present at your site by complying with the requirements in this Part.

**Note:** *These requirements do not apply to those products, materials, or wastes that are not a source of storm water contamination or that are designed to be exposed to storm water.*

To ensure you **meet** this requirement, you must:

- i. For building products<sup>16</sup>: In storage areas, provide either (1) cover (e.g., plastic sheeting or temporary roofs) to prevent these products from coming into contact with rainwater, or (2) a similarly effective means designed to prevent the discharge of pollutants from these areas.
- ii. For pesticides, herbicides, insecticides, fertilizers, and landscape materials:
  - 1) In storage areas, provide either (1) cover (e.g., plastic sheeting or temporary roofs) to prevent these chemicals from coming into contact with rainwater, or (2) a similarly effective means designed to prevent the discharge of pollutants from these areas; and
  - 2) Comply with all application and disposal requirements included on the registered pesticide, herbicide, insecticide, and fertilizer label.
- iii. For diesel fuel, oil, hydraulic fluids, other petroleum products, and other chemicals:
  - 1) To comply with the prohibition in Part 2.3.1.c, store chemicals in water-tight containers, and provide either (1) cover (e.g., plastic sheeting or temporary roofs) to prevent these containers from coming into contact with rainwater, or (2) a similarly effective means designed to prevent the discharge of pollutants from these areas (e.g., spill kits), or provide secondary containment (e.g., spill berms, decks, spill containment pallets); and
  - 2) Clean up spills immediately, using dry clean-up methods where possible, and dispose of used materials properly. Do not clean surfaces or spills by hosing the area down. Eliminate the source of the spill to prevent a discharge or a continuation of an ongoing discharge.
- iv. For hazardous or toxic waste<sup>17</sup>:
  - 1) Separate hazardous or toxic waste from construction and domestic waste;
  - 2) Store waste in sealed containers, which are constructed of suitable materials to prevent leakage and corrosion, and which are labeled in

---

<sup>16</sup> Some examples of building products that are typically stored at construction sites include, but are not limited to, asphalt sealants, copper flashing, roofing materials, adhesives, concrete admixtures.

<sup>17</sup> Examples of hazardous or toxic waste that may be present at construction sites include, but are not limited to, paints, solvents, waste paints or solvents, petroleum-based products, wood preservatives, additives, curing compounds, acids.

- accordance with applicable Resource Conservation and Recovery Act (RCRA) requirements and all other applicable state, or local requirements;
- 3) Store all containers that will be stored outside within appropriately sized secondary containment (e.g., spill berms, decks, spill containment pallets) to prevent spills from being discharged, or provide a similarly effective means designed to prevent the discharge of pollutants from these areas (e.g., storing chemicals in covered area or having a spill kit available on site);
  - 4) Dispose of hazardous or toxic waste in accordance with the manufacturer's recommended method of disposal and in compliance with federal, state, tribal, and local requirements; and
  - 5) Clean up spills immediately, using dry clean-up methods where possible, and dispose of used materials properly. Do not clean surfaces or spills by hosing the area down. Eliminate the source of the spill to prevent a discharge or a furtherance of an ongoing discharge.
- v. For construction and domestic waste<sup>18</sup>: Provide waste containers (e.g., dumpster or trash receptacle) of sufficient size and number to contain construction and domestic wastes. In addition, you must:
- 1) On work days, clean up and dispose of waste in designated waste containers; and
  - 2) Clean up immediately if containers overflow.
- vi. For sanitary waste: Position portable toilets so that they are secure and will not be tipped or knocked over and that they will be positioned at least 10 feet from any storm water conveyance, inlet, curb or gutter; or that they will have secondary containment if tipped.
- d. **Washing of Applicators and Containers used for Paint, Concrete, or Other Materials.** To comply with the prohibition in Parts 2.3.1.a and 2.3.1.b, you must provide an effective means of eliminating the discharge of water from the washout and cleanout of stucco, paint, concrete, form release oils, curing compounds, and other construction materials. To comply with this requirement, you must:
- i. Direct all washwater into a leak-proof container or leak-proof pit. The container or pit must be designed so that no overflows can occur due to inadequate sizing or precipitation; you must segregate paint waste and oily waste from stucco/concrete washout waste and manage the proper disposal separately.

---

<sup>18</sup> Examples of construction and domestic waste include, but are not limited to, packaging materials, scrap construction materials, masonry products, timber, pipe and electrical cuttings, plastics, styrofoam, concrete, and other trash or building materials.

ii. Handle washout or cleanout wastes as follows:

- 1) Do not dump liquid wastes in storm sewers;
- 2) Dispose of liquid wastes in accordance with applicable requirements in Part 2.3.3.c; and
- 3) Washout or cleanout activities may be located near the areas where concrete or stucco application takes place (and in accordance with local ordinances), but it should be at least 50 feet and possibly further (where practical) from surface waters, and to the extent practicable, designate areas to be used for these activities and require all conducting such activities to only in these areas.

e. Dispose of hardened concrete waste in ways that are consistent with Utah disposal laws for inert material.

2.3.4. **Emergency Spill Notification.** You are prohibited from discharging toxic or hazardous substances from a spill or other release, consistent with Part 2.3.1.e. Where a leak, spill, or other release containing a hazardous substance or oil in an amount equal to or in excess of a reportable quantity established under either 40 CFR Part 110, 40 CFR Part 117, or 40 CFR Part 302 occurs during a 24-hour period, you must notify the National Response Center (NRC) at (800) 424-8802 in accordance with the requirements of 40 CFR Part 110, 40 CFR Part 117, and 40 CFR Part 302 (the federal requirement), and 801-536-4123 (for State agencies), but also you must look up numbers for local health departments and MS4 spill and hazardous waste release reporting as soon as you have knowledge of the discharge. You must also, within 7 calendar days of knowledge of the release, provide a description of the release, the circumstances leading to the release, and the date of the release.

2.3.5. **Fertilizer Discharge Restrictions.** You are required to minimize discharges of fertilizers containing nitrogen or phosphorus. To meet this requirement, you must comply with the following requirements:

- a. Apply at a rate and in amounts consistent with manufacturer's specifications, or document departures from the manufacturer specifications where appropriate in Part 7.2.6.b of the SWPPP;
- b. Apply at the appropriate time of year for your location, and preferably timed to coincide as closely as possible to the period of maximum vegetation uptake and growth;
- c. Avoid applying before heavy rains that could cause excess nutrients to be discharged;
- d. Never apply to frozen ground;
- e. Never apply to storm water conveyance channels with flowing water; and
- f. Follow all other state, and local requirements regarding fertilizer application.

### 3. WATER QUALITY-BASED EFFLUENT LIMITATIONS.

#### 3.1. GENERAL EFFLUENT LIMITATION TO MEET APPLICABLE WATER QUALITY STANDARDS.

Your discharge must be controlled as necessary to meet applicable water quality standards. In the absence of information demonstrating otherwise, DWQ expects that compliance with the conditions in this permit will result in storm water discharges being controlled as necessary to meet applicable water quality standards. If at any time you become aware, or DWQ (or a local inspector representing an MS4) determines, that your discharge is not being controlled as necessary to meet applicable water quality standards, you must take corrective action as required in Part 5.2.1, and document the corrective actions as required in Part 5.2.2 and Part 5.4. DWQ will also impose additional water quality-based limitations on a site-specific basis, or require you to obtain coverage under an individual permit, if information indicates that your discharges are not controlled as necessary to meet applicable water quality standards. This includes situations where additional controls are necessary to comply with a wasteload allocation in a DWQ established TMDL.

#### 3.2. DISCHARGE LIMITATIONS FOR IMPAIRED WATERS.

If you discharge to a surface water that is impaired for (1) sediment or a sediment related parameter, such as total suspended solids (TSS) or turbidity, and/or (2) nutrients, including impairments for nitrogen and/or phosphorus, you are required to comply with the requirements in Part 3.2.2.

**Note:** For the purposes of this Part, “impaired waters” are waters identified as impaired on the appropriate CWA Section 303(d) list, or waters with a DWQ and EPA-approved or established TMDL. Your construction site will be considered to discharge to an impaired water if the first surface water to which you discharge is identified by DWQ or the EPA pursuant to Section 303(d) of the CWA as not meeting an applicable water quality standard, or is included in a DWQ and EPA-approved or established total maximum daily load (TMDL). In the future discharges under this permit may be required to meet the requirements of an impaired water that may be somewhere down the line from the first water body that the discharge outfalls into. That time may be when this permit is modified or after it is renewed. For discharges that enter a storm sewer system prior to discharge, the first surface water to which you discharge is the waterbody that receives the storm water discharge from the storm sewer system. If you discharge to an impaired water that is impaired for a parameter other than a sediment-related parameter or nutrients, DWQ will inform you if any additional limits or controls are necessary for your discharge to be controlled as necessary to meet water quality standards, including for it to be consistent with the assumptions of any available wasteload allocation in any applicable TMDL, or if coverage under an individual permit is necessary in accordance with Part 1.4.5. If during your coverage under a previous permit, you were required to install and maintain storm water controls specifically to meet the assumptions and requirements of a DWQ established TMDL (for any parameter) or to otherwise control your discharge to meet water quality standards, you must continue to implement such controls as part of this permit.

**3.2.1. Identify If You Discharge To An Impaired Water.** If you discharge to an impaired water, you must provide the following information in your SWPPP:

- A list of all impaired waters to which you discharge;
- The pollutant(s) for which the surface water is impaired; and
- Whether a TMDL has been approved or established for the waters to which you

discharge.

3.2.2. **Requirements for Discharges to Sediment or Nutrient-Impaired Waters.** If you discharge to a surface water that is impaired for (1) sediment or a sediment related parameter (e.g., total suspended solids (TSS) or turbidity) and/or (2) nutrients (e.g., nitrogen and/or phosphorus), including impaired waters for which a TMDL has been approved or established for the impairment, you are required to comply with the following storm water control requirements, which supplement the requirements applicable to your site in other corresponding parts of the permit.

- a. **Frequency of Site Inspection.** You must conduct inspections at the frequency specified in Part 4.1.3.
- b. **Deadline to Complete Stabilization.** You must comply with the deadlines for completing site stabilization as specified in Part 2.2.3.

3.3. **DISCHARGES TO WATERS IDENTIFIED AS CATEGORY 1 or 2.**

3.3.1. **Identify if You Discharge to a Category 1 or Category 2 Water.** If you discharge to a water identified as a Category 1 or Category 2 water, you must indicate so on your NOI. See Appendix C for information on Utah waters.

**Note:** *For the purposes of this permit, you are considered to discharge to a Category 1 or 2 water if the first surface water to which you discharge is identified as Category 1 or 2. Category 1 or 2 refer to waters identified by the state as high quality waters. For discharges that enter a storm sewer system prior to discharge, the surface water to which you discharge is the first surface water that receives the storm water discharge from the storm sewer system.*

3.3.2. **Requirements for New Projects Discharging to Category 1 or 2 Waters.** For new projects, if you will discharge to a Category 1 or 2 water, you are required to comply with Parts 4.1.3 (inspection frequencies) and 2.2.3. (stabilization deadlines).

#### 4. INSPECTIONS.

##### 4.1. SITE INSPECTIONS.

###### 4.1.1. Person(s) Responsible for Inspecting the Site.

The person(s) inspecting your site may be a person on your staff or a third party you hire to conduct such inspections. You are responsible for ensuring that the person who conducts inspections is a “qualified person”, and currently certified.

**Note:** *A “qualified person” is a person knowledgeable in the principles and practice of erosion and sediment controls and pollution prevention, who possesses the skills to assess conditions at the construction site that could impact storm water quality, and the skills to assess the effectiveness of any storm water controls selected and installed to meet the requirements of this permit, such as but not limited to the following:*

- Utah Registered Storm Water Inspector (RSI)
- Certified Professional in Erosion and Sediment Control (CPESC)
- Certified Professional in Storm Water Quality (CPSWQ)
- Certified Erosion, Sediment, and Storm Water Inspector (CESSWI)
- Certified Inspector of Sediment and Erosion Control (CISEC)
- National Institute for Certification in Engineering Technologies, Erosion and Sediment Control, Level 3 (NICET)
- Utah Department of Transportation Erosion Control Supervisor (ECS)

4.1.2. **Frequency of Inspections.** At a minimum, you must conduct a site inspection in accordance with one of the two schedules listed below, unless you are subject to Part 4.1.3 or Part 4.1.4:

- a. At least once every 7 calendar days; or
- b. Once every 14 calendar days and within 24-hours of the occurrence of a storm event of 0.5 inches or greater. To determine if a storm event of 0.5 inches or greater has occurred on your site, you must either keep a properly maintained rain gauge on your site, or obtain the storm event information from a weather station that is representative of your location. For any day of rainfall that measures 0.5 inches or greater, you must record the total rainfall measured for that day in accordance with Part 4.1.7.a.iv.

**Note:** *Inspections are only required during the project’s normal working hours, however a rainfall event can happen after business hours. If a rain event occurs after hours on Friday it does not need to be inspected until Monday.*

**Note:** *You are required to specify in your SWPPP which schedule you will be following.*

**Note:** *“Within 24 hours of the occurrence of a storm event” means that you are required to conduct an inspection within 24 hours once a storm event has produced 0.5 inches, even if the storm event is still continuing. Thus, if you have elected to inspect bi-weekly in accordance with Part 4.1.2.b. and there is a storm event at your site that continues for multiple days, and each day of the storm produces 0.5 inches or more of rain, you are required to conduct an inspection*



*within 24 hours of the first day of the storm and within 24 hours after the end of the storm. Again, inspections are only required during the projects normal working hours.*

**4.1.3. Increase in Inspection Frequency for Sites Discharging to Sensitive Waters.** For any portion of the site that discharges to a sediment or nutrient-impaired water (see Part 3.2) or to a water that is identified as Category 1 or 2 (see Part 3.3), instead of the inspection frequency specified in Part 4.1.2, you must conduct inspections in accordance with the following inspection frequencies:

- a. Once every 7 calendar days; and
- b. Within 24 hours of the occurrence of a storm event of 0.5 inches or greater. To determine if a storm event of 0.5 inches or greater has occurred on your site, you must either keep a properly maintained rain gauge on your site, or obtain the storm event information from a weather station that is representative of your location. For any day of rainfall that measures 0.5 inches or greater, you must record the total rainfall measured for that day in accordance with Part 4.1.7.a.v

**Note:** *Inspections are only required during the project's normal working hours, however a rainfall event can happen after business hours. If a rain event occurs after hours on Friday it does not need to be inspected until Monday.*

**Note:** *"Within 24 hours of the occurrence of a storm event" means that you are required to conduct an inspection within 24 hours once a storm event has produced 0.5 inches, even if the storm event is still continuing. Thus, if there is a storm event at your site that continues for multiple days, and each day of the storm produces 0.5 inches or more of rain, you are required to conduct an inspection within 24 hours of the first day of the storm and within 24 hours after the end of the storm. Again inspections are only required during the projects normal working hours.*

**Note:** *If you qualify for any of the reduced inspection frequencies in Part 4.1.4, you may conduct inspections in accordance with Part 4.1.4 for any portion of your site that discharges to a sensitive water.*

**4.1.4. Reductions in Inspection Frequency.** Your inspection frequency may be reduced as follows:

- a. **For Temporarily Stabilized Areas.** You may reduce the frequency of inspections to once per month in any area of your site where the stabilization steps in Parts 2.2.1.b.i, 2.2.1.b.ii, and 2.2.2.b have been completed. When construction activity resumes in this portion of the site at a later date, the inspection frequency immediately increases to that required in Parts 4.1.2 or 4.1.3, if applicable. You must document the beginning and ending dates of this period in your records.
- b. **For Permanently Stabilized Areas.** If portions of the project area are permanently stabilized before the entire project is completed, stabilized, and terminated, these permanently stabilized areas no longer require an inspection, except in the case of inlet protection for drainage received from surrounding unstabilized areas.
- c. **For Frozen Conditions.**

- i. If you are suspending earth-disturbing activities due to frozen conditions, you may temporarily suspend inspections on your site until thawing conditions (see Appendix A, “thawing conditions”) begin to occur if:
  - 1) Runoff is unlikely due to continuous frozen conditions that are likely to continue at your site for at least 30 days based on historic seasonal averages. However, if unexpected weather conditions (such as above freezing temperatures or rain or snow events) make discharges likely, you must immediately resume your regular inspection frequency as described in Parts 4.1.2 or 4.1.3;
  - 2) Land disturbances have been suspended; and
  - 3) All disturbed areas of the site have been temporarily or permanently stabilized in accordance with Part 2.2.
- ii. If you are still conducting earth-disturbing activities during frozen conditions, you may reduce your inspection frequency to once per month if:
  - 1) Runoff is unlikely due to continuous frozen conditions that are likely to continue at your site for at least 30 days based on historic seasonal averages. However, if unexpected weather conditions (such as above freezing temperatures or rain or snow events) make discharges likely, you must immediately resume your regular inspection frequency as described in Parts 4.1.2 or 4.1.3; and
  - 2) Except for areas in which you are actively conducting earth disturbing activities, disturbed areas of the site have been temporarily or permanently stabilized in accordance with Part 2.2.

You must document the beginning and ending dates of this period in your SWPPP.

4.1.5. **Areas that Need to Be Inspected.** During your site inspection, you must at a minimum inspect the following areas of your site:

- a. All areas that have been cleared, graded, or excavated and that have not yet completed stabilization consistent with Part 2.2;
- b. All storm water controls (including pollution prevention measures) installed at the site to comply with this permit;
- c. Material, waste, borrow, or equipment storage and maintenance areas that are covered by this permit;
- d. All areas where storm water typically flows within the site, including drainage ways designed to divert, convey, and/or treat storm water;
- e. All points of discharge from the site; and

- f. All locations where stabilization measures have been implemented.

You are not required to inspect areas that, at the time of the inspection, are considered unsafe for your inspection personnel. You are also not required to inspect areas of the project that are permanently stabilized except for management of storm water flows flowing onto the area coming from other areas that have not been permanently stabilized.

**4.1.6. Requirements for Inspections.** During your site inspection, you must at a minimum:

- a. Check whether all erosion and sediment controls and pollution prevention controls are installed, appear to be operational, and are working as intended to minimize pollutant discharges. Determine if any controls need to be replaced, repaired, or maintained in accordance with Parts 2.1.1.d. and 2.3.2;
- b. Check for the presence of conditions that could lead to spills, leaks, or other accumulations of pollutants on the site;
- c. Identify any locations where new or modified storm water controls are necessary to meet the requirements of Parts 2 and/or 3;
- d. At points of discharge and, if applicable, the banks of any surface waters flowing within your property boundaries or immediately adjacent to your property, check for signs of visible erosion and sedimentation (i.e., sediment deposits) that have occurred and are attributable to discharges from your site; and
- e. Identify any and all incidents of noncompliance observed.
- f. If a discharge is occurring during your inspection, you are required to:
  - i. Identify all points of the property from which there is a discharge;
  - ii. Observe and document the visual quality of the discharge, and take note of the characteristics of the storm water discharge, including color; odor; floating, settled, or suspended solids; foam; oil sheen; and other obvious indicators of storm water pollutants (see the form in Appendix J); and
  - iii. Document whether your storm water controls are operating effectively, and describe any such controls that are clearly not operating as intended or are in need of maintenance.
- g. Based on the results of your inspection, initiate corrective action under Part 5.

**4.1.7. Inspection Report.**

- a. **Requirement to Complete Inspection Report.** You must complete an inspection report within 24 hours of completing any site inspection. Each inspection report must include the following:
  - i. The inspection date;

- ii. The UPDES CGP permit tracking number;
  - iii. Names and titles (or position) of personnel making the inspection;
  - iv. A summary of your inspection findings, covering at a minimum the observations you made in accordance with Part 4.1.6;
  - v. If you are inspecting your site at the frequency specified in Part 4.1.2.b, Part 4.1.3, or Part 4.1.4.c, and you conducted an inspection because of rainfall measuring 0.5 inches or greater, you must include the applicable rain gauge or weather station readings that triggered the inspection; and
  - vi. If you have determined that it is unsafe to inspect a portion of your site, you must describe the reason you found it to be unsafe and specify the locations that this condition applied to.
- b. **Signature Requirements.** Each inspection report must be signed in accordance with Appendix G, Part G.16 (Signatory Requirements) of this permit.
- c. **Recordkeeping Requirements.** You are required to keep a current, copy of all inspection reports at the site or at an easily accessible location, so that it can be made available at the time of an onsite inspection or upon request by DWQ. For purposes of this permit, your inspection reports may be kept electronically if the records are:
- i. In a format that can be read in a similar manner as a paper record;
  - ii. Legally defensible with no less evidentiary value than a paper equivalent; and
  - iii. Accessible to the inspector during an inspection to the same extent as a paper copy stored at the site would be, if the records were stored in paper form.

**Note:** *All inspection reports completed for this Part must be retained for at least 3 years from the date that your permit coverage expires or is terminated.*

#### 4.2. **INSPECTIONS BY DWQ OR MS4 OF JURISDICTION.**

You must allow an authorized representative of DWQ, the MS4 of jurisdiction, or the EPA; to conduct the following activities at reasonable times:

- 4.2.1. Enter onto areas of your site, including any construction support activity areas covered by this permit (see Part 1.3.3.), and onto locations where records are kept under the conditions of this permit;
- 4.2.2. Access and copy any records that must be kept under the conditions of this permit;
- 4.2.3. Inspect your construction site, including any construction support activity areas covered by this permit (see Part 1.3.3.) and any storm water controls installed and maintained at the site; and

- 4.2.4. Sample or monitor for the purpose of ensuring compliance.
- 4.2.5. Take photographs; videos; measurements; surveying; or other documentation to ensure or document compliance (with consideration to the permittee for legitimate confidentiality concerns, and for security concerns, including national security issues, if there are any).

5. **CORRECTIVE ACTIONS.**

5.1. **“CORRECTIVE ACTIONS” DEFINED.**

Corrective actions are actions you take in compliance with this Part to:

- Repair, modify, or replace any storm water control used at the site;
- Clean up and properly dispose of spills, releases, or other deposits; or
- Remedy a permit violation.

5.2. **REQUIREMENTS FOR TAKING CORRECTIVE ACTION.**

Immediately take all reasonable steps to minimize or prevent the discharge of pollutants until a permanent solution for the problem is installed and made operational.

*Note: In this context, the term “immediately” requires permittees to, on the same day a condition requiring corrective action is found (or as soon afterward as possible considering normal work schedule and task size), take all reasonable steps to minimize or prevent the discharge of pollutants until a permanent solution is installed and made operational.*

- 5.2.1. Install a new or modified control, make it operational, or complete the repair expeditiously and based on urgency<sup>19</sup> installing the storm water control(s), making them operational, or completing a repair as soon as practicable.

5.3. **CORRECTIVE ACTION REQUIRED BY DWQ, THE LOCAL MS4, OR THE EPA INSPECTORS.** You must comply with any corrective actions required by DWQ, the local MS4, or the EPA inspectors as a result of permit violations found during an inspection carried out under Part 4.2.

5.4. **TRACKING OF CORRECTIVE ACTION.** For each corrective action taken in accordance with this Part, you must make an entry in a corrective action report/log, inspection reports, or other method the permittee has devised to track corrective action, which includes the applicable information in Parts 5.4.1 and 5.4.2.

5.4.1. Within a day or so of discovering the occurrence of a storm water or pollution control problem at your site, you must make an entry in a report/log or other device for monitoring corrective action of the following:

- a. What condition was identified at your site that required corrective action (BMPs were not installed, installed incorrectly, were not effective, or need repairing);
- b. The date and time the condition was identified and how it was identified (inspection report, happened to notice it needed maintenance, etc.).

---

<sup>19</sup> What is meant by expeditiously based on urgency is assessing the difficulty of the task, the resources available to complete the task, and the time required to complete the task while considering the urgency of performing the task. A less urgent situation would be placing a storm water control measure in a flat area during a dry season of the year with no precipitation in the forecast and that is a significant distance from a water body or inlet. An urgent situation would be placing a storm water control measure on a slope with precipitation eminent in the forecast and having a water body or inlet close by that would receive the runoff from the area. In any case corrective action should not be put off many days. Direction given during an inspection from DWQ or an MS4 inspector may determine the immediacy needed for the action.

- 5.4.2. Within 7 calendar days of discovering the occurrence of a problem with a storm water or pollution control measure at your site, you must make an entry in a corrective action report/log (or other corrective action monitoring devise) of the following:
- a. Any follow-up actions taken to repair the problem, including the dates such actions occurred;
  - b. Notice of whether SWPPP modifications are required as a result of the condition identified or corrective action.
- 5.4.3. **Recordkeeping Requirements.** You are required to keep a current copy of all corrective action entries at the site or at an easily accessible location, so that it can be made available at the time of an onsite inspection or upon request by DWQ or the local jurisdictional MS4. For purposes of this permit, your corrective action entries may be kept electronically if the records are:
- a. In a format that can be read in a similar manner as a paper record;
  - b. Legally defensible with no less evidentiary value than a paper equivalent; and
  - c. Accessible to the inspector during an inspection to the same extent as a paper copy stored at the site would be, if the records were stored in paper form.

All corrective action entries completed for this Part must be retained for at least 3 years from the date that your permit coverage expires or is terminated.

**6. STAFF TRAINING REQUIREMENTS.**

Prior to the commencement of earth-disturbing activities or pollutant-generating activities, whichever occurs first, you must ensure and document that the following personnel understand the requirements of this permit and their specific responsibilities with respect to those requirements:

- Personnel who are responsible for the design, installation, maintenance, and/or repair of storm water controls (including pollution prevention measures);
- Personnel responsible for the application and storage of treatment chemicals (if applicable);
- Personnel who are responsible for conducting inspections as required in Part 4.1.1; and
- Personnel who are responsible for taking corrective actions as required in Part 5.

**Notes:** (1) *If the person requiring training is a new employee, who starts after you commence earth-disturbing or pollutant-generating activities, you must ensure that this person has the proper understanding as required above prior to assuming particular responsibilities related to compliance with this permit.* (2) *For emergency-related construction activities, the requirement to train personnel prior to commencement of earth-disturbing activities does not apply, however, such personnel must have the required training prior to NOI submission.*

You are responsible for ensuring that all activities on the site comply with the requirements of this permit. Although you are not required to provide or document formal training for subcontractors or other outside service providers, you must ensure (through a contract if necessary) that such personnel understand and perform by any requirements of the permit and the SWPPP that may be affected by the work they are subcontracted to perform.

At a minimum, personnel must be trained to understand the following if related to the scope of their job duties (e.g., only personnel responsible for conducting inspections need to understand how to conduct inspections):

- The location of all storm water controls on the site required by this permit, and how they are to be maintained;
- The proper procedures to follow with respect to the permit's pollution prevention requirements; and
- When and how to conduct inspections, record applicable findings, and take corrective actions.



**7. STORM WATER POLLUTION PREVENTION PLAN (SWPPP).**

**7.1. GENERAL REQUIREMENTS.**

**7.1.1. Requirement to Develop a SWPPP Prior to Submitting Your NOI.** All owner/operators associated with a construction project to be covered under this permit must develop a SWPPP. You are required to develop your site's SWPPP prior to submitting your NOI. At a minimum, your SWPPP must include the information required in Part 7.2 and as specified in other parts of the permit.<sup>20</sup> You must also update the SWPPP as required in Part 7.4.

**Note:** *Although many aspects of developing a SWPPP do not require a P.E., there are significant portions or items required in the development of a SWPPP that makes it to where many if not all SWPPPs must include a P.E. in its development. It is not required for a P.E. to stamp the entire SWPPP because operators must have the flexibility to modify a SWPPP. There may be facilities within a SWPPP that need to be stamped and would require a review and to be re-stamped by a P.E. again if modifications occur. For the most part SWPPPs should be designed so that operators have the flexibility to make modifications and updates in the field as is necessary so that improvements can be made for the protection of disturbed soils and the quality of storm water runoff if SWPPP plans prove to be ineffective, or if the conditions at the site turn out to be different than expected. A P.E. knows what is not safe without a stamp.*

**Note:** *You may develop an electronic SWPPP that is stored on the internet as long as, 1) the SWPPP can be accessed during an inspection, and 2) site personnel know how to, and regularly access the SWPPP to manage and modify the site and SWPPP in accordance with requirements of this permit as if it were as accessible as a hard copy on the site.*

**Note:** *If your project is an "existing project"<sup>21</sup> or if you are a new owner and/or operator of an existing project", you are not required to meet the requirements of this permit until 6 months after this permit has been issued, however, you must meet the requirements of the previous permit (UTR300000) during that 6 month period (see permit 1.4.3).*

**7.2. SWPPP CONTENTS.** Your SWPPP must include the following information, at a minimum.

**7.2.1. Storm Water Team.** Each owner/operator, must assemble a "storm water team," which is responsible for overseeing the development of the SWPPP, any later modifications to it, and for compliance with the requirements in this permit.

The SWPPP must identify the personnel (by name or position) that are part of the storm water team, as well as their individual responsibilities. Each member of the storm water team must have ready access to an electronic or paper copy of applicable portions of this permit, the most updated copy of your SWPPP, and other relevant documents or information that must be kept with the SWPPP.

---

<sup>20</sup>The SWPPP does not establish the effluent limits that apply to your site's discharges; these limits are established in this permit in Parts 2 and 3.

<sup>21</sup>Your project started before this permit was issued, and you had active and legitimate coverage under UTR300000 at the time of expiration of UTR300000.

- 7.2.2. **Nature of Construction Activities.** The SWPPP must describe the nature of your construction activities, including the size of the property (in acres) and the total area expected to be disturbed by the construction activities (in acres), construction support activity areas covered by this permit (see Part 1.3.3), and the maximum area expected to be disturbed at any one time.
- 7.2.3. **Emergency-Related Projects.** If you are conducting earth-disturbing activities in response to a public emergency (see Part 1.2.1), you must document the cause of the public emergency (e.g., natural disaster, extreme flooding conditions, etc.), provide information substantiating its occurrence (e.g., state disaster declaration or similar state or local declaration), and provide a description of the construction necessary to reestablish effected public services.
- 7.2.4. **Sequence and Estimated Dates of Construction Activities.** The SWPPP must include a description of the intended sequence of construction activities, including a schedule of the estimated start dates and the duration of the activity, for the following activities:
- a. Installation of storm water control measures, and when they will be made operational, including an explanation of how the sequence and schedule for installation of storm water control measures complies with Part 2.1.1.c.i. and of any departures from manufacturer specifications pursuant to Part 2.1.1.c.ii.;
  - b. Commencement and duration of earth-disturbing activities, including clearing and grubbing, mass grading, site preparation (i.e., excavating, cutting and filling), final grading, and creation of soil and vegetation stockpiles requiring stabilization;
  - c. Cessation, temporarily or permanently, of construction activities on the site, or in designated portions of the site;
  - d. Final or temporary stabilization of areas of exposed soil. The dates for stabilization must reflect the applicable deadlines to which you are subject in Part 2.2.1 and 2.2.2; and
  - e. Removal of temporary storm water conveyances/channels and other storm water control measures, removal of construction equipment and vehicles, and cessation of any pollutant-generating activities.

*Note: If plans change due to unforeseen circumstances or for other reasons, the requirement to describe the sequence and estimated dates of construction activities is not meant to “lock in” the permittee to meeting these projections. When departures from initial projections are necessary, this should be documented in the SWPPP itself or in associated records, as appropriate.*

- 7.2.5. **Site Map.** The SWPPP must include a legible site map, or series of maps, showing the following features of your project:

*Note: Included in the project site are any construction support activities covered by this permit (see Part 1.3.3).*

- a. Boundaries of the property and of the locations where construction activities will occur, including:
  - i. Locations where earth-disturbing activities will occur, noting any phasing of construction activities;
  - ii. Approximate slopes before and after major grading activities. Note areas of steep slopes, as defined in Appendix A;
  - iii. Locations where sediment, soil, or other construction materials will be stockpiled;
  - iv. Locations of any crossings of surface waters;
  - v. Designated points on the site where vehicles will exit onto paved roads;
  - vi. Locations of structures and other impervious surfaces upon completion of construction; and
  - vii. Locations of construction support activity areas covered by this permit (see Part 1.3.3).
- b. Locations of all surface waters, including wetlands, that exist within or in the immediate vicinity of the site. Indicate which water bodies are listed as impaired, and which are identified as Category 1 or 2 waters;
- c. The boundary lines of any natural buffers provided consistent with Part 2.1.2.a.i.
- d. Topography of the site, existing vegetative cover (e.g., forest, pasture, pavement, structures), and drainage pattern(s) of storm water and authorized non-storm water flow onto, over, and from the site property before and after major grading activities;
- e. Storm water and allowable non-storm water discharge locations, including:
  - i. Locations of any storm drain inlets on the site and in the immediate vicinity of the site; and

**Note:** *The requirement to show storm drain inlets in the immediate vicinity of the site on your site map only applies to those inlets that are easily identifiable from your site or from a publicly accessible area immediately adjacent to your site.*

- ii. Locations where storm water or allowable non-storm water will be discharged to surface waters (including storm sewer systems and/or wetlands) on or near the site.
- f. Locations of all potential pollutant-generating activities identified in Part 7.2.6;
- g. Locations of storm water control measures; and

- h. Locations where tackifiers, polymers, flocculants, fertilizers, or other treatment chemicals will be used and stored.

**7.2.6. Construction Site Pollutants.** The SWPPP must include the following:

- a. A list and description of all the pollutant-generating activities<sup>22</sup> on your site.
- b. For each pollutant-generating activity, an inventory of pollutants or pollutant constituents (e.g., sediment, fertilizers and/or pesticides, paints, solvents, fuels) associated with that activity, which could be exposed to rainfall, or snowmelt, and could be discharged from your construction site. You must take into account where potential spills and leaks could occur that contribute pollutants to storm water discharges. You must also document any departures from the manufacturer's specifications for applying fertilizers containing nitrogen and phosphorus, as required in Part 2.3.5.a.

**7.2.7. Non-Storm water Discharges.** The SWPPP must also identify all sources of allowable non-storm water discharges listed in Part 1.3.4. All non-storm water discharges must be managed or treated to prevent a discharge of pollutants.

*Note: Allowable discharges listed in section 1.3.4. must be managed such that they are infiltrated into the ground so sediment and any oil sheen will be filtered out into surface soils appropriately (not overloading soil capacity to degrade pollutants), or be otherwise treated so that pollutants are not discharged with storm water.*

**7.2.8. Buffer Documentation.** If you are required to comply with Part 2.1.2.a because a surface water is located within 50 feet of your project's earth disturbances, you must describe which compliance alternative you have selected for your site, and comply with any additional requirements to provide documentation in Part 2.1.2.a.

**7.2.9. Description of Storm water Control Measures.**

- a. **Storm water Control Measures to be Used During Construction Activity.**  
The SWPPP must describe all storm water control measures that are or will be installed and maintained at your site to meet the requirements of Part 2. For each storm water control measure, you must document:
  - i. Information on the type of storm water control measure to be installed and maintained, including design information;
  - ii. What specific sediment controls will be installed and made operational prior to conducting earth-disturbing activities in any given portion of your site to meet the requirement of Part 2.1.2.b.i.;
  - iii. For exit points on your site, document stabilization techniques you will use and any additional controls that are planned to remove sediment prior to vehicle exit consistent with Part 2.1.2.c.; and

---

<sup>22</sup> Examples of pollutant-generating activities include, but are not limited to: paving operations; concrete, paint, and stucco washout and waste disposal; solid waste storage and disposal; and dewatering operations.

- iv. For projects at high altitudes that expect long seasons of heavy snow, you must document in your SWPPP when the snow season is expected so spring runoff controls can be installed before snowfall.
  - v. For linear projects, where you have determined that the use of perimeter controls in portions of the site is impracticable, document why you believe this to be the case (see Part 2.1.2.b.i.).
- b. **Use of Treatment Chemicals.** If you plan to use cationic polymers and/or flocculants, you must have an approval letter from DWQ. Otherwise for treatment chemicals at your site you must include the following in your SWPPP:
- i. A listing of all soil types<sup>23</sup> that are expected to be exposed during construction and that will be discharged to locations where chemicals will be applied. Also include a listing of soil types expected to be found in fill material to be used in these same areas, to the extent you have this information prior to construction.
  - ii. A listing of all treatment chemicals to be used at the site, and why the selection of these chemicals is suited to the soil characteristics of your site;
  - iii. If you have been authorized by DWQ to use cationic treatment chemicals, include the specific controls and implementation procedures designed to ensure that your use of cationic treatment chemicals will not lead to a violation of water quality standards or a fish kill;
  - iv. The dosage of all treatment chemicals you will use at the site or the methodology you will use to determine dosage;
  - v. Information from any applicable Material Safety Data Sheets (MSDS);
  - vi. Schematic drawings of any chemically-enhanced storm water controls or chemical treatment systems to be used for application of the treatment chemicals;
  - vii. A description of how chemicals will be stored consistent with Part 2.1.3.c.iii.
  - viii. References to applicable state or local requirements affecting the use of treatment chemicals, and copies of applicable manufacturer's specifications regarding the use of your specific treatment chemicals and/or chemical treatment systems; and
  - ix. A description of the training that personnel who handle and apply chemicals have received prior to permit coverage, or will receive prior to use of the treatment chemicals at your site.
- c. **Stabilization Practices.** The SWPPP must describe the specific vegetative and/or non-vegetative practices that will be used to comply with the requirements in Part 2.2, including:

---

<sup>23</sup> Information on soils may be obtained at <http://websoilsurvey.nrcs.usda.gov/app/>.

- i. If you will be complying with the stabilization deadlines specified in Part 2.2.2., you must indicate in your SWPPP the beginning and ending dates of the seasonally dry period and your site conditions; and
- ii. For projects at high altitudes that expect long seasons of heavy snow, you must document in your SWPPP when the snow season is expected and so stabilization measures for spring runoff can be installed before snowfall.

**7.2.10. Pollution Prevention Procedures.**

- a. **Spill Prevention and Response Procedures.** The SWPPP must describe procedures that you will follow to prevent and respond to spills and leaks consistent with Part 2.3, including:
  - i. Procedures for expeditiously stopping, containing, and cleaning up spills, leaks, and other releases. Identify the name or position of the employee(s) responsible for detection and response of spills or leaks; and
  - ii. Procedures for notification of appropriate facility personnel, emergency response agencies, and regulatory agencies where a leak, spill, or other release containing a hazardous substance or oil in an amount equal to or in excess of a reportable quantity consistent with Part 2.3.4 and established under either 40 CFR Part 110, 40 CFR Part 117, or 40 CFR Part 302, occurs during a 24-hour period. Contact information must be in locations that are readily accessible and available.

You may also reference the existence of Spill Prevention Control and Countermeasure (SPCC) plans developed for the construction activity under Part 311 of the CWA, or spill control programs otherwise required by a UPDES permit for the construction activity, provided that you keep a copy of that other plan onsite.

*Note: Even if you already have an SPCC or other spill prevention plan in existence, your plans will only be considered adequate if they meet all of the requirements of this Part, either as part of your existing plan or supplemented as part of the SWPPP.*

- b. **Waste Management Procedures.** The SWPPP must describe procedures for how you will handle and dispose of all wastes generated at your site, including, but not limited to, clearing and demolition debris, sediment removed from the site, construction and domestic waste, hazardous or toxic waste, and sanitary waste.

**7.2.11. Procedures for Inspection, Maintenance, and Corrective Action.** The SWPPP must describe the procedures you will follow for maintaining your storm water control measures, conducting site inspections, and, where necessary, taking corrective actions, in accordance with Part 2.1.1.d., Part 2.3.2, Part 4, and Part 5 of the permit. The following information must also be included in your SWPPP:

- a. Personnel responsible for conducting inspections;

- b. The inspection schedule you will be following, which is based on whether your site is subject to Part 4.1.2 or Part 4.1.3, and whether your site qualifies for any of the allowances for reduced inspection frequencies in Part 4.1.4. If you will be conducting inspections in accordance with the inspection schedule in Part 4.1.2.b. or Part 4.1.3, the location of the rain gauge on your site or the address of the weather station you will be using to obtain rainfall data;
- c. If you will be reducing your inspection frequency in accordance with Part 4.1.4.c., the beginning and ending dates of frozen conditions on your site; and
- d. Any inspection or maintenance checklists or other forms that will be used.
- e. for each storm water control measure you must describe the strategy and schedule you plan to employ to maintain storm water control measures in effective operating condition for each precipitation event or you will be expected to replace, repair, and/or maintain problems found with storm water control measures immediately after each inspection.

7.2.12. **Staff Training.** The SWPPP must include documentation that the required personnel were trained in accordance with Part 6, and all other relevant training be documented (including training in Section 2 for projects that use treatment chemicals).

7.2.13. **UIC Class 5 Injection Wells.**

- a. **Utah Water Quality Act Underground Injection Control (UIC) Program Requirements for Certain Subsurface Storm Water Controls.** If you are using any of the following storm water controls at your site, as they are described below, you must document any contact you have had with DWQ for implementing the requirements for underground injection wells in the Safe Drinking Water Act and DEQ's implementing regulations at UAC R317-7. In addition there may be local requirements related to such structures. Such controls (below) would generally be considered Class V UIC wells and all UIC Class V wells must be reported to DWQ for an inventory:
  - i. French drains (if storm water is directed to any bored, drilled, driven shaft or dug hole that is deeper than its widest surface dimension, or has a subsurface fluid distribution system);
  - ii. Commercially manufactured pre-cast or pre-built proprietary subsurface detention vaults, chambers, or other devices designed to capture and infiltrate storm water flow; and
  - iii. Drywells, seepage pits, or improved sinkholes (if storm water is directed to any bored, drilled, driven shaft or dug hole that is deeper than its widest surface dimension, or has a subsurface fluid distribution system).

**Note:** For the State UIC Contact at DWQ call 801-536-4300.

7.2.14. List of Impaired Waters that Receive a Discharge and the following information (see paragraph 3.2.1):

- a. A list of all impaired waters to which you discharge;
- b. The pollutant(s) for which the surface water is impaired; and
- c. Whether a TMDL has been approved or established for the waters to which you discharge.

7.2.15. **SWPPP Certification.** The owner/operator must sign and date your SWPPP in accordance with Appendix G, Part G.16.1.2 & 1.3.

7.2.16. **Also Included in the SWPPP.** Once you have completed the submission of your on-line NOI (or paper submission for some), you must include the following documents as part of your SWPPP:

- a. A copy of your NOI,
- b. A copy of this permit (an electronic copy easily available to the storm water team is also acceptable).

### 7.3. ON-SITE AVAILABILITY OF YOUR SWPPP.

You are required to maintain a current copy of the project SWPPP at every active construction site where this permit is required, and where construction workers and construction activity related to the project is occurring. The SW Team and/or site workers must be able to refer to SWPPP and update it as needed to manage the site according to permit requirements and as outlined in the SWPPP (it is not required that the SWPPP be on the site when construction workers leave for the day or when there is no activity occurring on the site, but at all times there must be posted contact information where the SWPPP can be obtained – see paragraph 1.5). The SWPPP must be available within 30 minutes<sup>24</sup> at the request of DWQ, MS4, or EPA inspectors during random inspections at active sites, or immediately for pre-scheduled inspections. Requests for a copy of the SWPPP by a regulatory authority (DWQ, EPA, or an MS4), must be accommodated within 72 hours, or as agreed upon by the permittee and the regulatory authority at the time. DWQ may provide access to portions of the project SWPPP to a member of the public upon request. Confidential Business Information (CBI) may be withheld from the public, but may not be withheld from DWQ, local regulating MS4, or the EPA.

**Note:** *Information covered by a claim of confidentiality will be disclosed by DWQ only to the extent of, and by means of, the procedures set forth in 40 CFR Part 2, Subpart B. In general, submitted information protected by a business confidentiality claim may be disclosed to other employees, officers, or authorized representatives of DWQ and/or the EPA. The authorized*

---

<sup>24</sup> On several occasions for smaller projects it has been noted that the location of site plans happens to be the project manager's vehicle. On larger sites the SWPPP may be in another location not close to the place a permitting authority may appear. Thirty minutes is provided for the case where a permitting authority shows up for an inspection and the SWPPP is on the site a distance from that exact location, or it is with the project manager who has recently left the site for a business reason, inadvertently taking the site plans (including the SWPPP) with him/her. This time allowance is for notification of the person who may have taken the SWPPP, so it can be returned, or to locate the SWPPP on the site and provide it for the permitting authority. It is intended that SWPPPs be maintained at the site when the site is active. The 30-minutes is not for retrieving the SWPPP from another site where it should not be.



*representatives, including employees of other executive branch agencies, may review CBI during the course of reviewing draft regulations. If an onsite location is unavailable to keep the SWPPP when no personnel are present, notice of the plan's location must be posted near the main entrance of your construction site.*

#### 7.4. REQUIRED SWPPP MODIFICATIONS.

7.4.1. **List of Conditions Requiring SWPPP Modification.** You must modify your SWPPP, including the site map(s), in response to any of the following conditions:

- a. Whenever you make changes to your construction plans, storm water control measures, pollution prevention measures, or other activities at your site that are no longer accurately reflected in your SWPPP. This includes changes made in response to corrective actions triggered under Part 5;
- b. To reflect areas on your site map where operational control has been transferred due to new ownership or a new operator (and the date of that transfer) since initiating permit coverage;
- c. If inspections or investigations by site staff, the MS4, DWQ, or the EPA determine that SWPPP modifications are necessary for compliance with this permit;
- d. Where DWQ, the EPA, or the MS4 determines it is necessary to impose additional requirements on your discharge, the following must be included in your SWPPP:
  - i. A copy of any correspondence describing such requirements; and
  - ii. A description of the storm water control measures that will be used to meet such requirements.
- e. To reflect any revisions to applicable federal, state, or local requirements that affect the storm water control measures implemented at the site; and
- f. If applicable, if a change in chemical treatment systems or chemically enhanced storm water control is made, including use of a different treatment chemical, different dosage rate, or different area of application.

7.4.2. **Deadlines for SWPPP Modifications.** You must complete required revisions to the SWPPP within 7 calendar days following the occurrence of any of the conditions listed in Part 7.4.1.

7.4.3. **SWPPP Modification Records.** You are required to maintain records showing the dates of all SWPPP modifications. The records must include the name of the person authorizing each change (see Part 7.2.15 above – this person can be a duly authorized representative as allowed in Appendix G.16.1.2, but should be a member of the storm water team) and a brief summary of all changes.

**Note:** *In most cases the date the modification was made with the initials of the person making the change is adequate.*

7.4.4. **Certification Requirements.** All modifications made to the SWPPP consistent with Part 7.4 must be authorized by a person identified in Appendix G, Part G.16.1.2.

## 8. HOW TO TERMINATE COVERAGE.

Until your permit coverage is terminate, you are required to comply with all conditions and effluent limitations in the permit, except that inspections can be suspended if the site has been prepared to meet the stabilization requirements found in Section 2.2. To begin the termination process, you must go to the DWQ on-line Storm Water data base and complete the steps for terminating your permit, or you must submit a complete and accurate Notice of Termination (NOT) form (that can be downloaded from the construction storm water web page for DWQ) to the DWQ and the MS4 (for all MS4s listed in Appendix E, you must submit a paper form to the MS4), which certifies that you have met the requirements for termination in Part 8. At this point the permit status changes to “unconfirmed termination”. The termination process is complete when DWQ or the MS4 (of jurisdiction) does a final inspection and the inspection is passed. At this point the status of the permit changes to “confirmed termination” and the permit is fully terminated.

### 8.1. MINIMUM INFORMATION REQUIRED IN NOT.

You will be required to provide the following in your NOT:

8.1.1. UPDES permit tracking number provided by the DWQ when you received coverage under this permit;

8.1.2. You must indicate if the termination request is:

- a. **Partial Site** – If the termination request is for a portion of the total area, on area that is no longer under your ownership, you and the new owner are required to submit an Ownership Transfer Form found in Appendix M, to DWQ (and the MS4 if a regulated MS4, see Appendix E). For a partial termination you must indicate (on the NOT) how many acres (to the hundredths) that will be eliminated as a result of the transfer transaction, and you must describe (in words) the area that will be transferred. A partial termination submission does not result in a change of the permit status (the remaining area is still under your permit tracking number with an active status);
- b. **Full Site** -- if the termination request is the entire area, it must be handled as follows:
  - i. **New Ownership.** A transfer of the entire site to a different owner. For this case you and the new owner are required to submit an Ownership Transfer Form found in Appendix M, to DWQ (and the MS4 if a regulated MS4, see Appendix E). The permit status will be changed from “active” to “unconfirmed termination”. DWQ or the MS4 of jurisdiction will change the permit status to “confirmed termination” after an inspection. Another way to transfer is described on the Ownership Transfer Form.
  - ii. **Project Completion.** The project is completed and stabilized according to section 2.2. The status of the project will change from “active” to “unconfirmed termination” which will change to “confirmed termination” after a final inspection by DWQ or the local MS4 has approve the termination in a final inspection.

8.1.3. Basis for submission of the NOT (see Part 8.2);

- 8.1.4. Owner/Operator contact information;
- 8.1.5. Name of project and address (or a description of location if no street address is available); and
- 8.1.6. NOT certification, and signature (in accordance with Appendix G, G.16.1.1 & 1.3).

**8.2. CONDITIONS FOR TERMINATING PERMIT COVERAGE.**

You must terminate permit coverage if one of the following conditions occurs at your site (either 8.2.1, 8.2.2, or 8.2.3 below):

- 8.2.1. You have completed all earth-disturbing activities at your site and, if applicable, construction support activities covered by this permit (see Part 1.3.3), and you have met the following requirements:
  - a. For any areas that (1) were disturbed during construction, (2) are not covered over by permanent structures, you have met the requirements for final vegetative or non-vegetative stabilization in Part 2.2;
  - b. You have removed and properly disposed of all construction materials, waste and waste handling devices, and have removed all equipment and vehicles that were used during construction, unless intended for long-term use following your termination of permit coverage;
  - c. You have removed all storm water controls that were installed and maintained during construction, except those that are intended for long-term use following your termination of permit coverage or those that are biodegradable to assist in areas where re-establishment of vegetation is especially difficult; and
  - d. You have removed all potential pollutants and pollutant-generating activities associated with construction, unless needed for long-term use following your termination of permit coverage; and
  - e. If within a regulated MS4 (see appendix E), you have notified the MS4 that the site is ready for a final inspection; or
- 8.2.2. For the entire site or for a part of the site, if ownership changes the portion of the site that changes ownership must be terminated.
  - a. If ownership changes for the entire site the party selling the site must terminate coverage (see paragraph 8.1.2).
  - b. If ownership changes for a portion of the site the permit holder must terminate only the portion of the site that changes ownership (see paragraph 8.1.2).
- 8.2.3. Completed homes that are occupied by home owners where at least temporary sediment and erosion controls are in place are allowed to be terminated without final stabilization. If a home owner buys a newly completed house the permit can be terminated while the property is being transferred to the home owner. The home owner should not be involved in the permit process. If a home owner builds his/her

house, they must terminate the permit when the house is approved for occupancy where temporary storm water controls are in place on the site.

8.2.4. Coverage under an individual or alternative general UPDES permit has been obtained.

**8.3. FINAL INSPECTION ASSOCIATED WITH TERMINATION.**

After submission of an NOT, for most cases, there will be a final inspection by the permitting authority (DWQ or the MS4 with jurisdictional authority for the area). A NOT is not complete until the permitting authority approves the site for termination unless the permitting authority does not perform the inspection within a year of the submission of the NOT after it was submitted.

**8.4. HOW TO SUBMIT YOUR NOT.**

8.4.1. It is preferred that the DWQ “on-line” NOI system be used to submit an electronic NOT.

Access to the DWQ on-line storm water data base is found at the DWQ webpage at <http://www.waterquality.utah.gov/UPDES/stormwatercon.htm>. A click on Online Application Process and Search for Existing Permits found on that page will take you to the “on line” storm water data base where NOIs and NOTs are submitted. You must logon to the account created when the NOI was submitted and find the terminate (or NOT) button for the permit tracking number when you wish to terminate a coverage. In the case where the permittee does not have access to the account where the NOI was submitted the permittee must either contact DWQ and request account access or fill out and submit to DWQ a paper form of the NOT which can be downloaded from the same DWQ website.

**8.5. DEADLINE FOR SUBMITTING NOT.**

You must submit an NOT within 30 calendar days after any one of the triggering conditions in Part 8.2 occur.

**8.6. EFFECTIVE DATE OF TERMINATION OF COVERAGE.**

Your authorization to discharge under this permit terminates at midnight of the calendar day that a completed NOT is processed (meaning that storm water discharged from the site is not coming from a site involved with construction activity) on the DWQ “on-line” storm water data base, unless the results of the final inspection indicate problems that need addressing.

Appendix A - Definitions and Acronyms

**Definitions**

“Act” – is a reference to the Utah Water Quality Act, or Utah Code Annotated Title 19, Chapter 5.

“Agricultural Land” - cropland, grassland, rangeland, pasture, and other agricultural land, on which agricultural and forest-related products or livestock are produced and resource concerns may be addressed. Agricultural lands include cropped woodland, marshes, incidental areas included in the agricultural operation, and other types of agricultural land used for the production of livestock.

“Antidegradation Policy” or “Antidegradation Requirements” - the water quality standards regulation that requires maintenance of water quality:

Waters whose existing quality is better than the established standards for the designated uses will be maintained at high quality unless it is determined by the Board, after appropriate intergovernmental coordination and public participation in concert with the Utah continuing planning process, allowing lower water quality is necessary to accommodate important economic or social development in the area in which the waters are located. However, existing instream water uses shall be maintained and protected. No water quality degradation is allowable which would interfere with or become injurious to existing instream water uses.

In those cases where potential water quality impairment associated with a thermal discharge is involved, the antidegradation policy and implementing method shall be consistent with Section 316 of the Federal Clean Water Act.

**Category 1 Waters:** Waters which have been determined by the Board to be of exceptional recreational or ecological significance or have been determined to be a State or National resource requiring protection, shall be maintained at existing high quality through designation, by the Board after public hearing, as Category 1 Waters. New point source discharges of wastewater, treated or otherwise, are prohibited in such segments after the effective date of designation. Protection of such segments from pathogens in diffuse, underground sources is covered in R317-5 and R317-7 and the Regulations for Individual Wastewater Disposal Systems (R317-501 through R317-515). Other diffuse sources (nonpoint sources) of wastes shall be controlled to the extent feasible through implementation of best management practices or regulatory programs.

Discharges may be allowed where pollution will be temporary and limited after consideration of the factors in R317-2-3.5.b.4., and where best management practices will be employed to minimize pollution effects.

Waters of the state designated as Category 1 Waters are listed in UAC R317-2-12.1.

**Category 2 Waters:** Category 2 Waters are designated surface water segments which are treated as Category 1 Waters except that a point source discharge may be permitted provided that the discharge does not degrade existing water quality. Discharges may be allowed where pollution will be temporary and limited after consideration of the factors in UAC R317-2-3.5.b.4., and where best management practices will be employed to

minimize pollution effects. Waters of the state designated as Category 2 Waters are listed in UAC R317-2-12.2.

**Category 3 Waters:** For all other waters of the state, point source discharges are allowed and degradation may occur, pursuant to the conditions and review procedures outlined in the paragraph below (Antidegradation Review).

**Antidegradation Review (ADR):** An antidegradation review will determine whether the proposed activity complies with the applicable antidegradation requirements for receiving waters that may be affected.

An antidegradation review (ADR) may consist of two parts or levels. A Level I review is conducted to insure that existing uses will be maintained and protected.

Both Level I and Level II reviews will be conducted on a parameter-by-parameter basis. A decision to move to a Level II review for one parameter does not require a Level II review for other parameters. Discussion of parameters of concern is those expected to be affected by the proposed activity.

Antidegradation reviews shall include opportunities for public participation, as described in UAC R317-2-3.5e.

“Arid Areas” – areas with an average annual rainfall of 0 to 10 inches.

“Bank” (e.g., stream bank or river bank) – the rising ground bordering the channel of a water of the State of Utah.

“Bluff” – a steep headland, promontory, riverbank, or cliff.

“Borrow Areas” – the areas where materials are dug for use as fill, either onsite or off-site.

“Bypass” – the intentional diversion of waste streams from any portion of a treatment facility. See 40 CFR 122.41(m)(1)(i).

“Category 1, 2, and/or 3 Waters” – see “Antidegradation Policy” or “Antidegradation Requirements”.

“Cationic Treatment Chemical” – polymers, flocculants, or other chemicals that contain an overall positive charge. Among other things, they are used to reduce turbidity in storm water discharges by chemically bonding to the overall negative charge of suspended silts and other soil materials and causing them to bind together and settle out. Common examples of cationic treatment chemicals are chitosan and cationic PAM.

“Commencement of Earth-Disturbing Activities” - the initial disturbance of soils (or ‘breaking ground’) associated with clearing, grading, or excavating activities or other construction-related activities (e.g., stockpiling of fill material).

“Commencement of Pollutant-Generating Activities” – at construction sites (for the purposes of this permit) occurs in any of the following circumstances:

- Clearing, grubbing, grading, and excavation has begun;

- Raw materials related to your construction activity, such as building materials or products, landscape materials, fertilizers, pesticides, herbicides, detergents, fuels, oils, or other chemicals have been placed at your site;
- Use of authorized non-storm water for washout activities, or dewatering activities, have begun; or
- Any other activity has begun that causes the generation of or the potential generation of pollutants.

“Common Plan of Development or Sale” – is a plan to subdivide a parcel of land into separate parts for separate sale. This can be for a residential, commercial, or industrial development. The plan originates as a single parcel which is separated into parts. This usually goes through an approval process by a local governmental unit, but in some cases may not require that process. The original plan is considered the “common plan of development or sale” whether phased or completed in steps. If a further plan is conceived that was not foreseen during the original plan, or the original plan is added onto but the addition was conceived later and was not included in any part of the original plan concept and/or development, and it develops after the completion of the construction of the entire original plan, it would be a separate “common plan of development or sale”. More than one owner of developable land can purposely join together and develop a single common plan of development or sale, but without a determined effort and coordinated planning, land owned by different owners would not be considered part of a single common plan of development or sale. For UPDES storm water permit purposes a common plan must have been initiated after October, 1992. A common plan of development or sale remains so until each lot or section of the development has fulfilled its planned purposes (e.g. in a residential development as homes are completed, stabilized, and sold or occupied). As lots or separated sections of the development are completed, the lot or section is stabilized, and the plan purposes are fulfilled for that area, lot, or section; it is no longer part of the common plan of development or sale (e.g. if a home is sold in a development and the owner decides to add a garage somewhere on the lot, that garage project is not part of the common plan of development or sale. In this process a common plan of development or sale may become reduced in size and/or separated by completed areas (which are no longer part of the common plan of development or sale), but all unfinished lots remain part of the same common plan development or sale until they are completed, stabilized, and fulfilled according to the purposes of the plan). Common Plans of Development or Sale can be commercial or industrial also.

“Construction Activities” – earth-disturbing activities, such as the clearing, grading, and excavation of land.

“Construction and Development Effluent Limitations and New Source Performance Standards” (C&D Rule) – as published in 40 CFR § 450 is the regulation requiring effluent limitations guidelines (ELG’s) and new source performance standards (NSPS) for controlling the discharge of pollutants from construction sites.

“Construction Site” – the land or water area where construction activities will occur and where storm water controls will be installed and maintained. The construction site includes construction support activities, which may be located at a different part of the property from where the primary construction activity will take place, or on a different piece of property altogether. The construction site is often a smaller subset of the lot or parcel within which the project is taking place.



“Construction Support Activities” – a construction-related activity that specifically supports the construction activity and involves earth disturbance or pollutant-generating activities of its own, and can include activities associated with concrete or asphalt batch plants, equipment staging yards, materials storage areas, excavated material disposal areas, and borrow areas.

“Construction Waste” – discarded material (such as packaging materials, scrap construction materials, masonry products, timber, steel, pipe, and electrical cuttings, plastics, and styrofoam).

“Conveyance Channel” – a temporary or permanent waterway designed and installed to safely convey storm water flow within and out of a construction site.

“Corrective Action” – for the purposes of the permit, any action taken to (1) repair, modify, or replace any storm water control used at the site; (2) clean up and dispose of spills, releases, or other deposits found on the site; and (3) remedy a permit violation.

“CWA” – the Clean Water Act or the Federal Water Pollution Control Act, 33 U.S.C. section 1251 et seq.

“Dewatering” – the act of draining rainwater and/or groundwater from building foundations, vaults, and trenches.

“Director” – the director of the Division of Water Quality.

“Discharge” – it can mean discharge of storm water or “discharge of a pollutant.”

“Discharge of a Pollutant” – any addition of any “pollutant” or combination of pollutants to “waters of the State” from any “point source,” or any addition of any pollutant or combination of pollutants to the waters of the State. This includes additions of pollutants into waters of the State from: surface runoff which is collected or channeled by man; discharges through pipes, sewers, or other conveyances, leading into privately owned treatment works. See 40 CFR 122.2.

“Discharge Point” – for the purposes of this permit, the location where collected and concentrated storm water flows are discharged from the construction site.

“Discharge-Related Activity” – activities that cause, contribute to, or result in storm water and allowable non-storm water point source discharges, and measures such as the siting, construction, and operation of storm water controls to control, reduce, or prevent pollutants from being discharged.

“Discharge to an Impaired Water” – for the purposes of this permit, a discharge to an impaired water occurs if the first water of the State to which you discharge is identified by DWQ or EPA pursuant to Section 303(d) of the Clean Water Act as not meeting an applicable water quality standard, or is included in an EPA-approved or DWQ established total maximum daily load (TMDL). For discharges that enter a storm sewer system prior to discharge, the water of the State to which you discharge is the first water of the State that receives the storm water discharge from the storm sewer system.

“Domestic Waste” – for the purposes of this permit, typical household trash, garbage or rubbish items generated by construction activities.

“Drainageway” – an open linear depression, whether constructed or natural, that functions for the collection and drainage of surface water.

“Drought-Stricken Area” – for the purposes of this permit, an area in which the National Oceanic and Atmospheric Administration’s U.S. Seasonal Drought Outlook indicates for the period during which the construction will occur that any of the following conditions are likely: (1) “Drought to persist or intensify”, (2) “Drought ongoing, some improvement”, (3) “Drought likely to improve, impacts ease”, or (4) “Drought development likely”. See [http://www.cpc.ncep.noaa.gov/products/expert\\_assessment/season\\_drought.gif](http://www.cpc.ncep.noaa.gov/products/expert_assessment/season_drought.gif).

“Earth-Disturbing Activity” or “Land-Disturbing Activity” – actions taken to alter the existing vegetation and/or underlying soil of a site, such as clearing, grading, site preparation (e.g., excavating, cutting, and filling), soil compaction, and movement and stockpiling of top soils.

“Effective Operating Condition” – for the purposes of this permit, a storm water control is kept in effective operating condition if it has been implemented and maintained in such a manner that it is working as designed to minimize pollutant discharges.

“Effluent Limitations” – for the purposes of this permit, any of the Part 2 or Part 3 requirements.

“Effluent Limitations Guideline” (ELG) – defined in 40 CFR § 122.2 as a regulation published by the EPA Administrator under section 304(b) of CWA to adopt or revise effluent limitations.

“Electronic Notice of Intent” – DWQ’s online system for submitting electronic Construction General Permit forms.

“Eligible” – for the purposes of this permit, refers to storm water and allowable non-storm water discharges that are authorized for coverage under this general permit.

“Emergency-Related Project” – a project initiated in response to a public emergency (e.g., natural disaster, disruption in essential public services), for which the related work requires immediate authorization to avoid imminent endangerment to human health or the environment, or to reestablish essential public services.

“Excursion” – a measured value that exceeds a specified limit.

“Existing Project” – a construction project that commenced construction activities prior to the issuance date of this permit.

“Existing Permit Coverage” – means for a permittee that he/she had permit coverage under a previous permit (e.g., UTR300000), prior to the issuance of this permit.

“Exit Points” – any points of egress from the construction site to be used by vehicles and equipment during construction activities.

“Exposed Soils” – for the purposes of this permit, soils that as a result of earth-disturbing activities are disturbed and exposed to the elements of weather.

“Final Stabilization” – on areas not covered by permanent structures, either (1) vegetation has been established, or for arid or semi-arid areas, the area has been designed and prepared so that with time it is expected to be established a uniform (e.g., evenly distributed, without large bare

areas) perennial vegetative cover of 70 percent of the natural background vegetative cover, or (2) non-vegetative stabilization methods have been implemented to provide effective cover for exposed portions of the site.

“Groundwater” – water that resides in the ground, even if only temporarily for the time it is in the ground, in the voids and interstitial spaces around soil particles.

“Hazardous Materials” or “Hazardous Substances” or “Hazardous or Toxic Waste” – for the purposes of this permit, any liquid, solid, or contained gas that contain properties that are dangerous or potentially harmful to human health or the environment. See also 40 CFR §261.2.

“Impaired Water” or “Water Quality Impaired Water” or “Water Quality Limited Segment” – for the purposes of this permit, waters identified as impaired on the CWA Section 303(d) list, or waters with an EPA-approved or established TMDL. Your construction site will be considered to discharge to an impaired water if the first water of the state to which you discharge is identified by DWQ pursuant to Section 303(d) of the CWA as not meeting an applicable water quality standard, or is included in an EPA-approved or DWQ established total maximum daily load (TMDL). For discharges that enter a storm sewer system prior to discharge, the first water of the state to which you discharge is the water body that receives the storm water discharge from the storm sewer system.

“Impervious Surface” – for the purpose of this permit, any land surface with a low or no capacity for soil infiltration including, but not limited to, pavement, sidewalks, parking areas and driveways, packed gravel or soil, or rooftops.

“Indian Country” or “Indian Country Lands” – defined at 40 CFR §122.2 as:

1. All land within the limits of any Indian reservation under the jurisdiction of the United States Government, notwithstanding the issuance of any patent, and, including rights-of way running through the reservation;
2. All dependent Indian communities within the borders of the United States whether within the originally or subsequently acquired territory thereof; and
3. All Indian allotments, the Indian titles to which have not been extinguished, including rights-of-ways running through the same.

“Infeasible” – for the purpose of this permit, infeasible means not technologically possible or not economically practicable and achievable in light of best industry practices. DWQ notes that it does not intend for any permit requirement to conflict with state water rights law.

“Install” or “Installation” – when used in connection with storm water controls, to connect or set in position storm water controls to make them operational.

“Intermittent (or Seasonal) Stream” – one which flows at certain times of the year when groundwater provides water for stream flow, as well as during and immediately after some precipitation events or snowmelt.

“Jar test” – a test designed to simulate full-scale coagulation/flocculation/sedimentation water treatment processes by taking into account the possible conditions.

“Landward” – positioned or located away from a water body, and towards the land.

“Level Spreader” – a temporary storm water control used to spread storm water flow uniformly over the ground surface as sheet flow to prevent concentrated, erosive flows from occurring.

“Linear Construction Project” – includes the construction of roads, bridges, conduits, substructures, pipelines, sewer lines, towers, poles, cables, wires, connectors, switching, regulating and transforming equipment and associated ancillary facilities in a long, narrow area.

“Minimize” – to reduce and/or eliminate to the extent achievable using storm water controls that are technologically available and economically practicable and achievable in light of best industry practices.

“Municipal Separate Storm Sewer System” or “MS4” – defined at 40 CFR §122.26(b)(8) as a conveyance or system of conveyances (including roads with drainage systems, municipal streets, catch basins, curbs, gutters, ditches, manmade channels, or storm drains):

1. Owned and operated by a state, city, town, county, district, association, or other public body (created by or pursuant to State law) having jurisdiction over disposal of sewage, industrial wastes, storm water, or other wastes, including special districts under State law such as a sewer district, flood control district or drainage district, or similar entity, or a designated and approved management agency under section 208 of the CWA that discharges to waters of the State;
2. Designed or used for collecting or conveying storm water;
3. Which is not a combined sewer; and
4. Which is not part of a Publicly Owned Treatment Works (POTW) as defined at 40 CFR §122.2.

“National Pollutant Discharge Elimination System” (NPDES) – defined at 40 CFR §122.2 as the national program for issuing, modifying, revoking and reissuing, terminating, monitoring and enforcing permits, and imposing and enforcing pretreatment requirements, under sections 307, 402, 318, and 405 of CWA. The term includes an ‘approved program.’

“Native Topsoil” – the uppermost layer of naturally occurring soil for a particular area, and is often rich in organic matter, biological activity, and nutrients.

“Native Vegetation” – the species of plants that have developed for a particular region or ecosystem and are considered endemic to that region or ecosystem.

“Natural Buffer” – for the purposes of this permit, an area of undisturbed natural cover surrounding surface waters within which construction activities are restricted. Natural cover includes the vegetation, exposed rock, or barren ground that exists prior to commencement of earth-disturbing activities.

“Natural Vegetation” – vegetation that occurs spontaneously without regular management, maintenance or species introductions, removals, and that generally has a strong component of native species.

“New Operator of a New or Existing Project” – an operator that through transfer and/or operation replaces the operator of an already permitted construction project.

“New Project” – a construction project that commences construction activities on or after July 1, 2013.

“New Source” – for the purpose of this permit, a construction project that commenced construction activities on or after the issuance date of this permit.

“New Source Performance Standards (NSPS)” – for the purposes of this permit, NSPS are technology-based standards that apply to construction sites that are new sources under 40 CFR 450.24.

“Non-Storm Water Discharges” – discharges that do not originate from storm events. They can include, but are not limited to, discharges of process water, air conditioner condensate, noncontact cooling water, vehicle wash water, sanitary wastes, concrete washout water, paint wash water, irrigation water, or pipe testing water.

“Non-Turbid” – is a term used in this permit to describe water that appears visually clear and there appears to be no evidence of silt or sediment present in the water.

“Notice of Intent” (NOI) – the form (electronic or paper) required for authorization of coverage under the Construction General Permit.

“Notice of Termination” (NOT) – the form (electronic or paper) required for terminating coverage under the Construction General Permit.

“Operational” – for the purpose of this permit, storm water controls are made “operational” when they have been installed and implemented, are functioning as designed, and are properly maintained.

“Operator” – for the purpose of this permit an operator is the party that has day-to-day operational control of those activities at a project that are necessary to ensure compliance with the permit conditions (e.g., they are authorized to direct workers at a site to carry out activities required by the permit). Operator in this context is generally considered to be the general contractor for a project.

“Ordinary High Water Mark” – the line on the shore established by fluctuations of water and indicated by physical characteristics such as a clear, natural line impressed on the bank, shelving, changes in the character of soil, destruction of terrestrial vegetation, and/or the presence of litter and debris.

“Outfall” – see “Discharge Point.”

“Owner” – for the purpose of this permit an owner usually has ownership of property on which construction activity is taking place, but it also includes ownership of a project for which construction activity is occurring on property that is owned or leased. An owner is the party that has ultimate control over construction plans and specifications, including the ability at the highest level to make modifications to those plans and specifications. “Owner” in this context is the party that has ultimate control over the destiny of a project.

“Permittee” – is the owner and/or operator named in the NOI for the project.

“Permitting Authority” – for the purposes of this permit, DWQ, the Executive Secretary for the Utah Water Quality Board, or an authorized representative.

“Point(s) of Discharge” – see “Discharge Point.”

“Point Source” – any discernible, confined, and discrete conveyance, including but not limited to, any pipe, ditch, channel, tunnel, conduit, well, discrete fissure, container, rolling stock concentrated animal feeding operation, landfill leachate collection system, vessel or other floating craft from which pollutants are or may be discharged. This term does not include return flows from irrigated agriculture or agricultural storm water runoff.

“Pollutant” – defined at 40 CFR §122.2. A partial listing from this definition includes: dredged spoil, solid waste, sewage, garbage, sewage sludge, chemical wastes, biological materials, heat, wrecked or discarded equipment, rock, sand, cellar dirt, and industrial or municipal waste.

“Pollutant-Generating Activities” – at construction sites (for the purposes of this permit), those activities that lead to or could lead to the generation of pollutants, either as a result of earth disturbance or a related support activity. Some of the types of pollutants that are typically found at construction sites are:

- sediment;
- nutrients;
- heavy metals;
- pesticides and herbicides;
- oil and grease;
- bacteria and viruses;
- trash, debris, and solids;
- treatment polymers; and
- any other toxic chemicals.

“Pollution Prevention Measures” – storm water controls designed to reduce or eliminate the addition of pollutants to construction site discharges through analysis of pollutant sources, implementation of proper handling/disposal practices, employee education, and other actions.

“Polymers” – for the purposes of this permit, coagulants and flocculants used to control erosion on soil or to enhance the sediment removal capabilities of sediment traps or basins. Common construction site polymers include polyacrylamide (PAM), chitosan, alum, polyaluminum chloride, and gypsum.

“Prohibited Discharges” – discharges that are not allowed under this permit, including:

1. Wastewater from washout of concrete;
2. Wastewater from washout and cleanout of stucco, paint, form release oils, curing compounds and other construction materials;
3. Fuels, oils, or other pollutants used in vehicle and equipment operation and maintenance;
4. Soaps or solvents used in vehicle and equipment washing;
5. Toxic or hazardous substances from a spill or other release; and

6. Waste, garbage, floatable debris, construction debris, and sanitary waste from pollutant generating activities.

“Provisionally Covered Under this Permit” – for the purposes of this permit, DWQ provides temporary coverage under this permit for emergency-related projects prior to receipt of a complete and accurate NOI. Discharges from earth-disturbing activities associated with the emergency-related projects are subject to the terms and conditions of the permit during the period of temporary coverage.

“Receiving Water” – a “Water of the State” is as defined in Utah Administrative Code R317-1-1.34, into which the regulated storm water discharges.

“Regulatory Authority” – as it pertains to this permit means EPA, DWQ, or a local MS4 that oversees construction activity.

“Run-On” – sources of storm water that drain from land located upslope or upstream from the regulated site in question.

“Semi-Arid Areas” – areas with an average annual rainfall of over 10 to 20 inches.

“Site” – for construction activities, the land or water area where earth-disturbing activities take place, including construction support activities.

“Small Construction Activity” – defined at Utah Administrative Code R317-8-3.9(6)(e)1. and incorporated here by reference. A small construction activity includes clearing, grading, and excavating resulting in a land disturbance that will disturb equal to or greater than one (1) acre and less than five (5) acres of land or will disturb less than one (1) acre of total land area but is part of a larger common plan of development or sale that will ultimately disturb equal to or greater than one (1) acre and less than five (5) acres. Small construction activity does not include routine maintenance that is performed to maintain the original line and grade, hydraulic capacity, or original purpose of the site.

“Small Residential Lot” – for the purpose of this permit, a lot being developed for residential purposes that will disturb less than 1 acre of land, but is part of a larger residential project that will ultimately disturb greater than or equal to 1 acre.

“Snowmelt” – the conversion of snow into overland storm water and groundwater flow as a result of warmer temperatures.

“Spill” – for the purpose of this permit, the release of a hazardous or toxic substance from its container or containment.

“Stabilization” – the use of vegetative and/or non-vegetative cover to prevent erosion and sediment loss in areas of disturbed soil exposed from the construction process.

“Steep Slopes” – for this permit steep slopes are defined as those that are 15 percent or greater in grade.

“Storm Sewer System” – a conveyance or system of conveyances (including roads with drainage systems, municipal streets, catch basins, curbs, gutters, ditches, manmade channels, or storm drains) designed or used for collecting or conveying storm water.

“Storm Water” – storm water runoff, snow melt runoff, and surface runoff and drainage.

“Storm Water Control Measure” - refers to any storm water control, BMP, or other method (including narrative effluent limitations) used to prevent or reduce the discharge of pollutants to waters of the state.

“Storm Water Controls” – see “Storm Water Control measure.”

“Storm Water Discharge Associated with Construction Activity” – as used in this permit, a discharge of pollutants in storm water to waters of the state from areas where land disturbing activities (e.g., clearing, grading, or excavation) occur, or where construction materials or equipment storage or maintenance (e.g., fill piles, borrow area, concrete truck chute wash down, fueling), or other industrial storm water directly related to the construction process (e.g., concrete or asphalt batch plants), are located.

“Storm Water Inlet” – an entrance or opening to a storm water conveyance system, generally placed below grade so as to receive storm water drainage from the surrounding area.

“Storm Water Team” – the group of individuals responsible for oversight of the development and modifications of the SWPPP, and oversight of compliance with the permit requirements. The individuals on the “Storm water Team” must be identified in the SWPPP.

“Storm Event” – a precipitation event that results in a measurable amount of precipitation.

“Storm Sewer” – a system of pipes (separate from sanitary sewers) that carries storm water runoff from buildings and land surfaces.

“Subcontractor” – for the purposes of this permit, an individual or company that takes a portion of a contract from the general contractor or from another subcontractor.

“Surface Water” – for this permit a surface water is defined all open water bodies, streams, lakes, ponds, marshes, wetlands, watercourses, waterways, springs, drainage systems, and all other bodies or accumulations of water on the surface only. Surface water is visible water, standing or flowing, above the surface of the ground.

“SWPPP” (Storm water Pollution Prevention Plan) – a site-specific, written document that, among other things: (1) identifies potential sources of storm water pollution at the construction site; (2) describes storm water control measures to reduce or eliminate pollutants in storm water discharges from the construction site; and (3) identifies procedures the operator will implement to comply with the terms and conditions of this general permit.

“Temporary Stabilization” – a condition where exposed soils or disturbed areas are provided a temporary vegetative and/or non-vegetative protective cover to prevent erosion and sediment loss. Temporary stabilization may include temporary seeding, geotextiles, mulches, and other techniques to reduce or eliminate erosion until either final stabilization can be achieved or until further construction activities take place to re-disturb this area.

“Thawing Conditions” – for the purposes of this permit, thawing conditions are expected based on the historical likelihood of two or more days with daytime temperatures greater than 32°F. This date can be determined by looking at historical weather data.



**Note:** *The estimation of thawing conditions is for planning purposes only. During construction the permittee will be required to conduct site inspections based upon actual conditions (i.e., if thawing conditions occur sooner than expected, the permittee will be required to conduct inspections at the regular frequency).*

“Total Maximum Daily Load” or “TMDL” – the sum of the individual wasteload allocations (WLAs) for point sources and load allocations (LAs) for nonpoint sources and natural background. If a receiving water has only one point source discharger, the TMDL is the sum of that point source WLA plus the LAs for any nonpoint sources of pollution and natural background sources, tributaries, or adjacent segments. TMDLs can be expressed in terms of either mass per time, toxicity, or other appropriate measure.

“Toxic Waste” – see “Hazardous Materials.”

“Turbidity” – when the term is used in a narrative it means a condition of water quality characterized by the presence of cloudiness usually caused by suspended solids and/or organic material. It refers to the visual clarity in water and is measured in a test passing light through a sample of water and quantifying the amount of light passing. The measurement is not directly proportional to the quantity of sediment in the water sample it is directly related to the quantity of light that passes through the sample. Particulate size and other factors can affect the amount of light that passes through the sample. This measurement is called nephelometric turbidity units or ntu.

“Uncontaminated Discharge” – a discharge that does not cause or contribute to an exceedence of applicable water quality standards.

“Upland” - the dry land area above and ‘landward’ of the ordinary high water mark.

“Upset” – Upset means an exceptional incident in which there is unintentional and temporary noncompliance with technology based permit effluent limitations because of factors beyond your reasonable control. An upset does not include noncompliance to the extent caused by operational error, improperly designed treatment facilities, inadequate treatment facilities, lack of preventive maintenance, or careless or improper operation. See 40 CFR 122.41(n)(1).

“Water-Dependent Structures” – structures or facilities that are required to be located directly adjacent to a waterbody or wetland, such as a marina, pier, boat ramp, etc.

“Water Quality Standards” –are provisions of State law which consist of a designated use or uses for the waters of the United States, water quality criteria for such waters based upon such uses, and an antidegradation policy to protect highquality waters. Water quality standards protect the public health or welfare, enhance the quality of water and serve the purposes of the Utah Water Quality Act.

“Waters of the State” – means all streams, lakes, ponds, marshes, water-courses, waterways, wells, springs, irrigation systems, drainage systems, and all other bodies or accumulations of water, surface and underground, natural or artificial, public or private, which are contained within, flow through, or border upon this state or any portion thereof, except that bodies of water confined to and retained within the limits of private property, and which do not develop into or constitute a nuisance, or a public health hazard, or a menace to fish and wildlife, shall not be considered to be "waters of the state" under this definition (Section 19-5-102).

“Wetland” – those areas that are inundated or saturated by surface or groundwater at a frequency and duration sufficient to support, and that under normal circumstances do support, a prevalence of vegetation typically adapted for life in saturated soil conditions. Wetlands generally include swamps, marshes, bogs, and similar areas. On-site evaluations are typically required to confirm the presence and boundaries of wetlands.

“Work day” – for the purposes of this permit, a work day is a calendar day on which construction activities will take place.

#### Acronyms

C&D – Construction & Development  
CGP – Construction General Permit  
CFR – Code of Federal Regulations  
CPoD – Common Plan of Development or Sale  
CWA – Clean Water Act  
DEQ – Department of Environmental Quality  
DDW – Division of Drinking Water  
DWQ – Division of Water Quality  
DNR – Department of Natural Resources  
DOG M – Department of Oil, Gas, and Mining  
EPA – United States Environmental Protection Agency  
ESA – Endangered Species Act  
FWS – United States Fish and Wildlife Service  
MS4 – Municipal Separate Storm Sewer System  
MSGP – Multi-Sector General Permit  
NHPA – National Historic Preservation Act  
NMFS – United States National Marine Fisheries Service  
NOI – Notice of Intent  
NOT – Notice of Termination  
NPDES – National Pollutant Discharge Elimination System  
NRC – National Response Center  
NRCS – National Resources Conservation Service  
POTW – Publicly Owned Treatment Works  
SPCC – Spill Prevention Control and Countermeasure  
SW – Storm Water  
SWMP – Storm Water Management Plan  
SWPPP – Storm Water Pollution Prevention Plan  
TMDL – Total Maximum Daily Load  
UAC – Utah Administrative Code  
UCA – Utah Code Annotated  
UCGP – Utah Construction General Permit  
UDOT – Utah Department of Transportation  
USGS – United States Geological Survey  
UWQA – Utah Water Quality Act  
WQS – Water Quality Standard

Appendix B - Small Construction Waivers and Instructions

These waivers are only available to storm water discharges associated with small construction activities (i.e., construction activity disturbing between 1-5 acres). As the owner/operator of a small construction activity, you may be able to qualify for a waiver in lieu of needing to obtain coverage under this general permit based on a low rainfall erosivity factor. Each owner/operator, otherwise needing permit coverage, must notify DWQ of its intention to employ this waiver. It is the responsibility of those individuals wishing to obtain a waiver from coverage under this general permit to submit a complete and accurate waiver certification as described below. Where the owner/operator changes or another is added during the construction project, the new owner/operator must also submit a waiver certification to be waived.

B.1 RAINFALL EROSIVITY WAIVER

Under this scenario the small construction project's rainfall erosivity factor calculation ("R" in the Revised Universal Soil Loss Equation) is less than 5 during the period of construction activity. The owner/operator must certify to DWQ that construction activity will occur only when the rainfall erosivity factor is less than 5. The period of construction activity begins at initial earth disturbance and ends with final stabilization. Where vegetation will be used for final stabilization, the date of installation of a stabilization practice that will provide interim non-vegetative stabilization can be used for the end of the construction period, provided the owner/operator commits (as a condition of waiver eligibility) to periodically inspect and properly maintain the area until the criteria for final stabilization as defined in the construction general permit have been met. If use of this interim stabilization eligibility condition was relied on to qualify for the waiver, signature on the waiver with its certification statement constitutes acceptance of and commitment to complete the final stabilization process. The owner/operator must submit a waiver certification to DWQ prior to commencing construction activities.

**Note:** *The rainfall erosivity factor "R" is determined in accordance with Chapter 2 of Agriculture Handbook Number 703, Predicting Soil Erosion by Water: A Guide to Conservation Planning With the Revised Universal Soil Loss Equation (RUSLE), pages 21–64, dated January 1997; United States Department of Agriculture (USDA), Agricultural Research Service.*

EPA has developed an online rainfall erosivity calculator to help small construction sites determine potential eligibility for the rainfall erosivity waiver. You can access the calculator from EPA's website at: [www.epa.gov/npdes/stormwater/lew](http://www.epa.gov/npdes/stormwater/lew). The R factor can easily be calculated by using the construction site latitude/longitude or address and estimated start and end dates of construction. This calculator may also be useful in determining the time periods during which construction activity could be waived from permit coverage. You may find that moving your construction activity by a few weeks or expediting site stabilization will allow you to qualify for the waiver. Use this online calculator or the Construction Rainfall Erosivity Waiver Fact Sheet ([www.epa.gov/npdes/pubs/fact3-1.pdf](http://www.epa.gov/npdes/pubs/fact3-1.pdf)) to assist in determining the R Factor for your small construction site.

If you are the owner/operator of the construction activity and are eligible for a waiver based on low erosivity potential, you can submit the erosivity waiver electronically on the DWQ on-line Storm Water data base (<https://secure.utah.gov/stormwater>) or provide the following information on the waiver certification form in order to be waived from permitting requirements:

1. Name, address and telephone number of the construction site owner/operator(s);

2. Name (or other identifier), address, county, city (if within an incorporated city boundary), and latitude/longitude of the construction project or site;
3. Estimated construction start and completion (i.e., final stabilization) dates, and total acreage (to the nearest quarter acre) to be disturbed;
4. The rainfall erosivity factor calculation that applies to the active construction phase at your project site; and
5. A statement, signed and dated by an authorized representative as provided in Appendix I, Subsection I.11, which certifies that the construction activity will take place during a period when the value of the rainfall erosivity factor is less than five

You can access the waiver certification form from DWQ's website at: (<http://www.waterquality.utah.gov/UPDES/stormwatercon.htm>). Paper copies of the form must be sent to one of the addresses listed in Part B.2 of this appendix.

**Note:** *If the R factor is 5 or greater, you cannot apply for the rainfall erosivity waiver, and must apply for UPDES permit coverage.*

If your small construction project continues beyond the projected completion date given on the waiver certification, you must recalculate the rainfall erosivity factor for the new project duration. If the R factor is below five (5), you must update all applicable information on the waiver certification and retain a copy of the revised waiver as part of your records. The new waiver certification must be submitted prior to the projected completion date listed on the original waiver form to assure your exemption from permitting requirements is uninterrupted. If the new R factor is 5 or above, you must obtain UPDES permit coverage.

## B.2 WAIVER DEADLINES AND SUBMISSIONS

1. Waiver certifications must be submitted prior to commencement of construction activities.
2. Late Notifications: Owner/Operators are not prohibited from submitting waiver certifications after initiating clearing, grading, excavation activities, or other construction activities. DWQ reserves the right to take enforcement for any unpermitted discharges that occur between the time construction commenced and waiver authorization is granted.

Submittal of a waiver certification is an optional alternative to obtaining permit coverage for discharges of storm water associated with small construction activity (construction activity disturbing 1-5 acres), provided you qualify for the waiver. Any discharge of storm water associated with small construction activity not covered by either a permit or a waiver may be considered an unpermitted discharge under the Clean Water Act. DWQ may notify any owner/operator covered by a waiver that they must apply for a permit. DWQ may notify any owner/operator who has been in non-compliance with a waiver that they may no longer use the waiver for future projects. Any member of the public may petition DWQ to take action under this provision by submitting written notice along with supporting justification. Complete and accurate Rainfall Erosivity waiver certifications not otherwise submitted electronically via DWQ's on-line Storm Water data base system (<https://secure.utah.gov/stormwater>) must be sent to the following address:

Construction Storm Water Waiver  
Utah DWQ  
PO Box 144870  
Salt Lake City, Utah 84114-4870

Appendix C – List with Information on Utah’s Waters

The site <http://wq.deq.utah.gov/> has a map of watershed assessment units which can be used to identify waters (rivers, creeks, lakes) and water quality information about them. If you can find the place on the map of the State of Utah and click where your project will occur, information will come up in the window on the left about the watershed assessment unit.

The information available on the watershed assessment unit is:

- Name of the watershed assessment unit or water body
- Category of water
- Beneficial uses of the water body
- If the water is impaired
- If impaired, what the cause of impairment is
- A contact name and phone number to obtain more information.

Appendix D – Buffer Guidance.

The following section was taken (nearly verbatim) from the EPA CGP. The EPA covers the entire US and therefore provides information from across the US. Data and information directly about Utah are not included. DWQ does not have the resources to modify this appendix to generate and include information only for Utah. The entire section is included to provide direction and help for permittees although examples within this treatise may also include areas not similar to Utah. For purposes of the permit it will suffice for a site in Utah to use the data from areas with similar climates (Idaho or New Mexico -- whichever matches the Utah site closest) to make the prescribed calculations.

The purpose of this guidance is to assist you in complying with the requirements in Part 2.1.2.a. of the permit regarding the establishment of natural buffers or equivalent sediment controls. This guidance is organized as follows:

- D.1. SITES THAT ARE REQUIRED TO COMPLY WITH PART 2.1.2.a. ....D-2.
  - D.1.1. Step 1 - Determine if Your Site is Within 50 Feet of a Surface Water .....D-2.
  - D.1.2. Step 2 - Determine if Any Exceptions to the Requirements in Part 2.1.2.a. Apply ...D-3.
- D.2 COMPLIANCE ALTERNATIVES GUIDANCE .....D-4.
  - D.2.1. Guidance for Providing and Maintaining Natural Buffers .....D-4.
    - D.2.1.1 Buffer Width Measurement .....D-5.
    - D.2.1.2 Limits to Disturbance Within the Buffer. ....D-7.
    - D.2.1.3 Discharges to the Buffer .....D-7.
    - D.2.1.4 SWPPP Documentation .....D-8.
  - D.2.2. Guidance for Providing the Equivalent Sediment Reduction as the 50-foot Buffer...D-8.
    - D.2.2.1 Determine Whether it is Feasible to Provide a Reduced Buffer.....D-8.
    - D.2.2.2 Design Controls That Provide Equivalent Sediment Reduction as 50-foot Buffer.....D-9.
      - a. Step 1 - Estimate the Sediment Reduction from the 50-foot Buffer D-10.
      - b. Step 2 - Design Controls That Match the Sediment Removal Efficiency of the 50-foot Buffer.....D-11.
      - c. Step 3 - Document How Site-Specific Controls Will Achieve the Sediment Removal Efficiency of the 50-foot Buffer .....D-12.
  - D.2.3 Small Residential Lot Compliance Alternatives.....D-13.
    - D.2.3.1 Step 1 – Determine if You are Eligible for the Small Residential Lot Compliance .....D-13.
    - D.2.3.2 Step 2 – Implement the Requirements of the Small Residential Lot Compliance Alternative Selected .....D-13.
      - a. Small Residential Lot Compliance Alternative 1 .....D-13.
      - b. Small Residential Lot Compliance Alternative 2 .....D-14.

D.1 SITES THAT ARE REQUIRED TO COMPLY WITH PART 2.1.2.a.

The purpose of this part is to help you determine if the requirements in Part 2.1.2.a. apply to your site.

D.1.1 Step 1 - Determine if Your Site is Within 50 Feet of a Surface Water

Part 2.1.2.a. applies to you only if your earth-disturbing activities will occur within 50 feet of a surface water that receives storm water discharges from your site. Figure D – 1 illustrates when a site would be required to comply with the requirements in Part 2.1.2.a. due to their proximity to a surface water. If the surface water is not located within 50 feet of the earth-disturbing activities, Part 2.1.2.a. does not apply.

Figure D - 1. Example of earth-disturbing activities within 50 feet of a surface water.

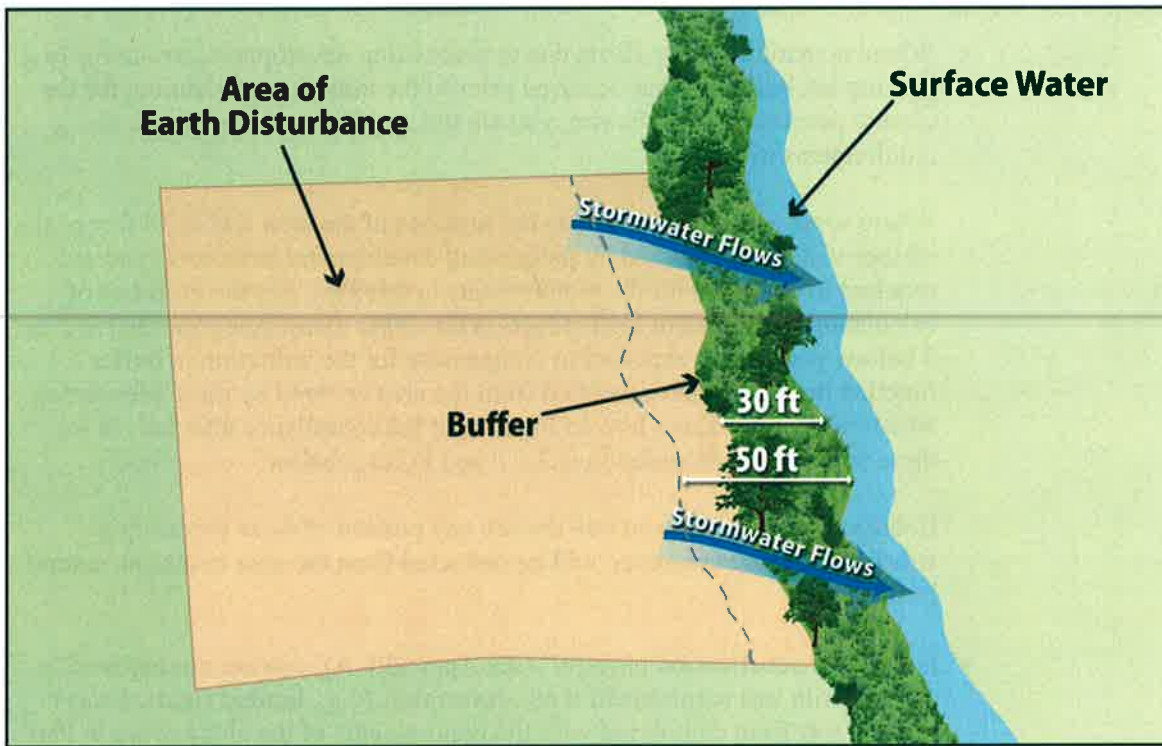

If you determine that your earth-disturbing activities will occur within 50 feet of a surface water that receives storm water discharges from your site, the requirements in Part 2.1.2.a. apply, except for certain circumstances that are described in Step 2.

Note that where some natural buffer exists but portions of the area within 50 feet of the surface water are occupied by preexisting development disturbances, or if a portion of area within 50 feet of the surface water is owned by another party and is not under your control, the buffer requirements in Part 2.1.2.a. still apply, but with some allowances.

Clarity about how to implement the compliance alternatives for these situations is provided in D.2.1.2 and D.2.2.2 below.

Note that DWQ does not consider designed storm water control features (e.g., storm water conveyance channels, storm drain inlets, storm water basins) that direct storm water to surface waters more than 50 feet from the disturbance to constitute surface waters for the purposes of determining if the buffer requirements apply.

D.1.2 Step 2 - Determine if Any Exceptions to the Requirements in Part 2.1.2.a. Apply.

The following exceptions apply to the requirements in Part 2.1.2.a:

- If there is no discharge of storm water to surface waters through the area between the disturbed portions of the site and any surface waters located within 50 feet of your site, you are not required to comply with the requirements in this Part. This includes situations where you have implemented controls measures, such as a berm or other barrier that will prevent such discharges.
- Where no natural buffer exists due to preexisting development structures (e.g. parking lot, building) that occurred prior to the initiation of planning for the current development of the site, you are not required to comply with the requirements in this Part.

Where some natural buffer exists but portions of the area within 50 feet of the surface water are occupied by preexisting development structures, you are required to comply with the requirements in this Part. For the purposes of calculating the sediment load reduction for either compliance alternative 2 or 3 below, you are not expected to compensate for the reduction in buffer function that would have resulted from the area covered by these preexisting structures. Clarity about how to implement the compliance alternatives for these situations is provided in D.2.1.2 and D.2.2.2 below.

If during your project, you will disturb any portion of these preexisting structures, the area removed will be deducted from the area treated as natural buffer.

- For “linear construction projects” (see Appendix A), you are not required to comply with this requirement if site constraints (e.g., limited right-of-way) prevent you from complying with the requirements of the alternatives in Part 2.1.2.a.i. provided that, to the extent practicable, you limit disturbances within 50 feet of the surface water and/or you provide supplemental erosion and sediment controls to treat storm water discharges from earth disturbances within 50 feet of the surface water. You must also document in your SWPPP your rationale for why it is infeasible for you to comply with the requirements in Part 2.1.2.a.i., and describe any buffer width retained and/or supplemental erosion and sediment controls installed.
- For “small residential lot” construction (i.e., a lot being developed for residential purposes that will disturb less than 1 acre of land, but is part of a common plan of development or sale that will disturb greater than or equal to 1 acre), you have the option of complying with the requirements in Part D.2.3 of this appendix.



- The following disturbances within 50 feet of a surface water are exempt from the requirements in this Part:
  - Construction approved under a CWA Section 404 permit; or
  - Construction of a water-dependent structure or water access areas (e.g., pier, boat ramp, trail).

Note that you must document in your SWPPP if any disturbances related to any of the above exceptions occurs within the buffer area on your site.

## D.2 COMPLIANCE ALTERNATIVES GUIDANCE.

If in Part D.1 of this guidance you determine that the buffer requirements apply to your site, you have three compliance alternatives from which you can choose:

1. Provide and maintain a 50-foot undisturbed natural buffer (Part 2.1.2.a.i.1));<sup>1</sup> or
2. Provide and maintain an undisturbed natural buffer that is less than 50 feet and is supplemented by additional erosion and sediment controls, which in combination achieves the sediment load reduction equivalent to a 50-foot undisturbed natural buffer (Part 2.1.2.a.i.2));<sup>1</sup> or
3. If it is infeasible to provide and maintain an undisturbed natural buffer of any size, you must implement erosion and sediment controls that achieve the sediment load reduction equivalent to a 50-foot undisturbed natural buffer (Part 2.1.2.a.i.3)).<sup>1</sup>

The compliance alternative selected above must be maintained throughout the duration of permit coverage.

The following provides detailed guidance for how you can comply with each of the compliance alternatives. Part D.2.1. below provides guidance on how to provide and maintain natural buffers consistent with the alternatives 1 and 2, above. Part D.2.2. below provides guidance on how to comply with the requirement to provide a 50-foot buffer equivalent through erosion and sediment controls consistent with alternatives 2 and 3, above.

### D.2.1 Guidance for Providing and Maintaining Natural Buffers.

The following guidance is intended to assist you in complying with the requirements to provide and maintain a natural buffer during construction. This part of the guidance

---

<sup>1</sup> For the compliance alternatives in 1 and 2, you are not required to enhance the quality of the vegetation that already exists in the buffer, or provide vegetation if none exists (e.g., arid and semi-arid areas). You only need to retain and protect from disturbance the natural buffer that existed prior to the commencement of construction. Any preexisting structures or impervious surfaces are allowed in the natural buffer provided you retain and protect from disturbance the natural buffer area outside the preexisting disturbance. Similarly, for alternatives 2 and 3, you are required to implement and maintain sediment controls that achieve the sediment load reduction equivalent to the undisturbed natural buffer that existed on the site prior to the commencement of construction. In determining equivalent sediment load reductions, you may consider naturally non-vegetated areas and prior disturbances. See Part D.2.2 of this Appendix for a discussion of how to determine equivalent reductions.

applies to you if you choose either alternative 1 (50-foot buffer) or alternative 2 (a buffer of < 50 feet supplemented by additional erosion and sediment controls that achieve the equivalent sediment load reduction as the 50-foot buffer), or if you are providing a buffer in compliance with one of the small residential lot compliance alternatives in Part D.2.3 below.

#### D.2.1.1 Buffer Width Measurement

Where you are retaining a buffer of any size, the buffer should be measured perpendicularly from any of the following points, whichever is further landward from the water:

1. The ordinary high water mark of the water body, defined as the line on the shore established by fluctuations of water and indicated by physical characteristics such as a clear, natural line impressed on the bank, shelving, changes in the character of soil, destruction of terrestrial vegetation, and/or the presence of litter and debris; or
2. The edge of the stream or river bank, bluff, or cliff, whichever is applicable.

Refer to Figure D – 2 and Figure D - 3. You may find that specifically measuring these points is challenging if the flow path of the surface water changes frequently, thereby causing the measurement line for the buffer to fluctuate continuously along the path of the waterbody. Where this is the case, EPA suggests that rather than measuring each change or deviation along the water's edge, it may be easier to select regular intervals from which to conduct your measurement. For instance, you may elect to conduct your buffer measurement every 5 to 10 feet along the length of the water.

Additionally, note that if earth-disturbing activities will take place on both sides of a surface water that flows through your site, to the extent that you are establishing a buffer around this water, it must be established on both sides. For example, if you choose alternative 1 above, and your project calls for disturbances on both sides of a small stream, you would need to retain the full 50 feet of buffer on both sides of the water. However, if your construction activities will only occur on one side of the stream, you would only need to retain the 50-foot buffer on the side of the stream where the earth disturbance will occur.

Figure D - 2. This image shows buffer measurement from the ordinary high water mark of the water body, as indicated by a clear natural line impressed on the bank, shelving, changes in the character of the soil, destruction of terrestrial vegetation, and/or the presence of litter/debris.

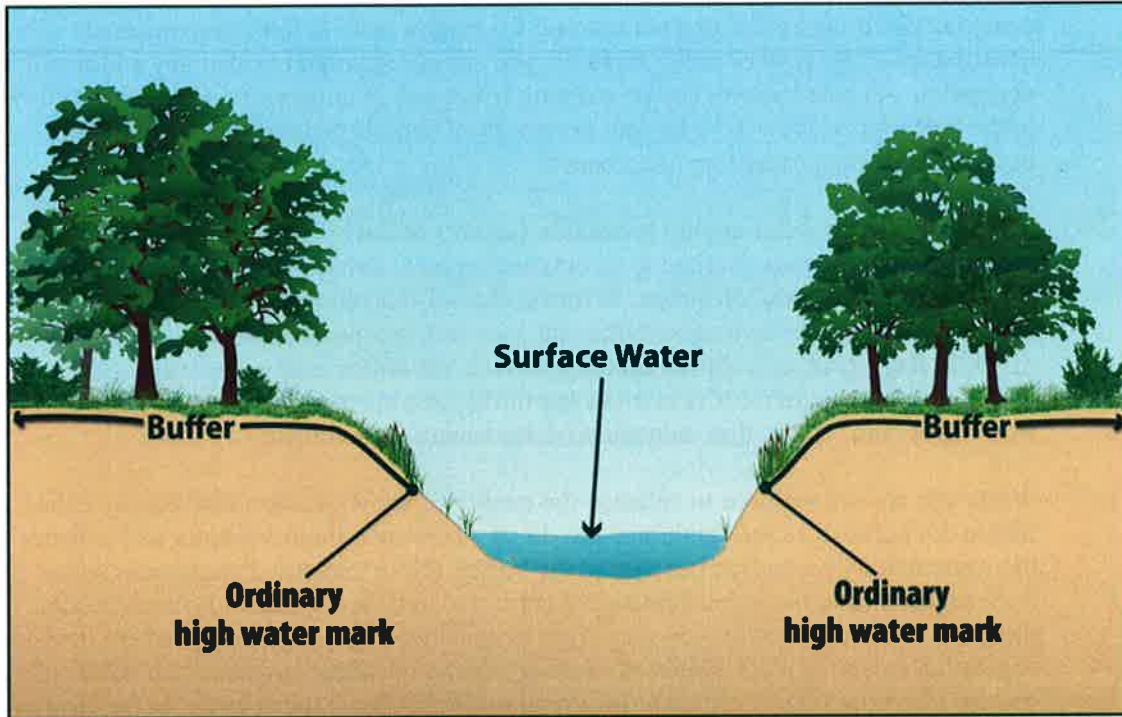
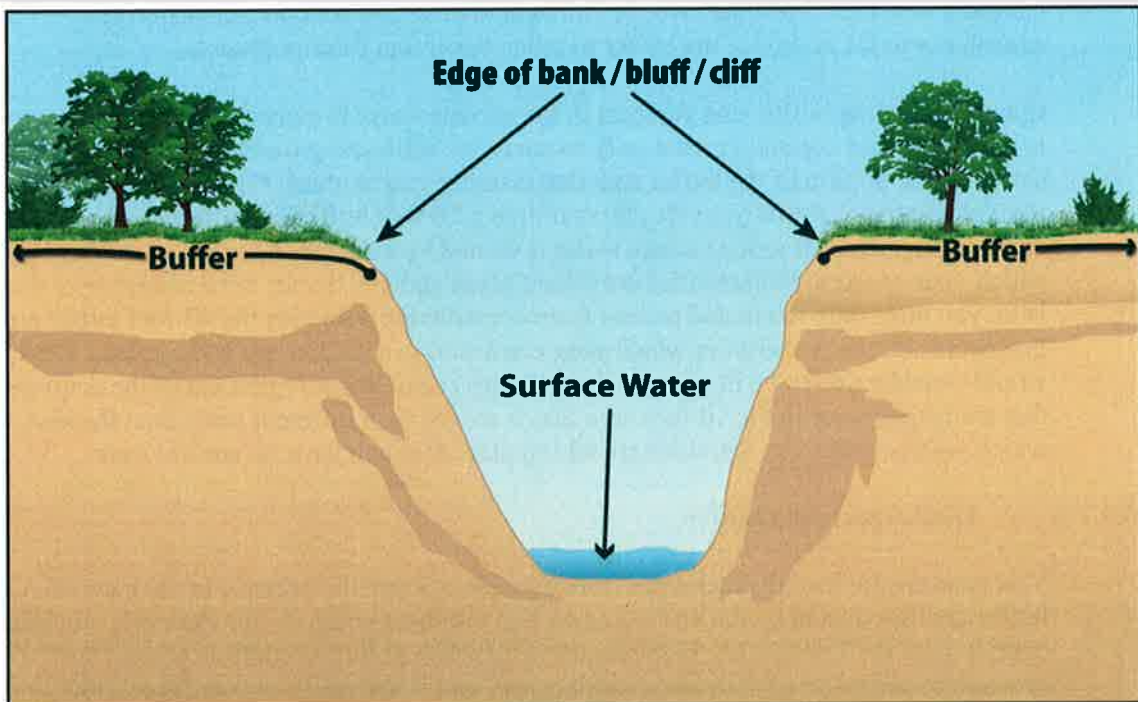

Figure D - 3. This image shows buffer measurement from the edge of the bank, bluff, or cliff, whichever is applicable.



D.2.1.2 Limits to Disturbance Within the Buffer

You are considered to be in compliance with this requirement if you retain and protect from construction activities the natural buffer that existed prior to the commencement of

construction. If the buffer area contains no vegetation prior to the commencement of construction (e.g., sand or rocky surface), you are not required to plant any additional vegetation. As noted above, any preexisting structures or impervious surfaces are allowed in the buffer provided you retain and protect from disturbance the vegetation in the buffer outside the preexisting disturbance.

To ensure that the water quality protection benefits of the buffer are retained during construction, you are prohibited from conducting any earth-disturbing activities within the buffer during permit coverage. In furtherance of this requirement, prior to commencing earth-disturbing activities on your site, you must delineate, and clearly mark off, with flags, tape, or a similar marking device, the buffer area on your site. The purpose of this requirement is to make the buffer area clearly visible to the people working on your site so that unintended disturbances are avoided.

While you are not required to enhance the quality of the vegetation that already exists within the buffer, you are encouraged to do so where such improvements will enhance the water quality protection benefits of the buffer. (Note that any disturbances within the buffer related to buffer enhancement are permitted and do not constitute construction disturbances.) For instance, you may want to consider targeted plantings where limited vegetation exists, or replacement of existing vegetation where invasive or noxious plant species (see <http://plants.usda.gov/java/noxiousDriver>) have taken over. In the case of invasive or noxious species, you may want to remove and replace them with a diversity of native trees, shrubs, and herbaceous plants that are well-adapted to the climatic, soil, and hydrologic conditions on the site. You are also encouraged to limit the removal of naturally deposited leaf litter, woody debris, and other biomass, as this material contributes to the ability of the buffer to retain water and filter pollutants.

If a portion of the buffer area adjacent to the surface water is owned by another party and is not under your control, you are only required to retain and protect from construction activities the portion of the buffer area that is under your control. For example, if you elect alternative 1 above (provide and maintain a 50-foot buffer), but 10 feet of land immediately adjacent to the surface water is owned by a different party than the land on which your construction activities are taking place and you do not have control over that land, you must only retain and protect from construction activities the 40-foot buffer area that occurs on the property on which your construction activities are taking place. DWQ would consider you to be in compliance with this requirement regardless of the activities that are taking place in the 10-foot area that is owned by a different party than the land on which your construction activities are taking place that you have no control over.

#### D.2.1.3. Discharges to the Buffer

You must ensure that all discharges from the area of earth disturbance to the natural buffer are first treated by the site's erosion and sediment controls (for example, you must comply with the Part 2.1.2.b. requirement to establish sediment controls around the downslope perimeter of your site disturbances), and if necessary to prevent erosion caused by storm water flows within the buffer, you must use velocity dissipation devices. The purpose of this requirement is to decrease the rate of storm water flow and encourage infiltration so that the pollutant filtering functions of the buffer will be achieved. To comply with this requirement, construction operators typically will use devices that physically dissipate storm water flows so that the discharge entering the buffer is spread out and slowed down.

D.2.1.4 SWPPP Documentation

You are required to document in your SWPPP the natural buffer width that is retained. For example, if you are complying with alternative 1, you must specify in your SWPPP that you are providing a 50-foot buffer. Or, if you will be complying with alternative 2, you must document the reduced width of the buffer you will be retaining (and you must also comply with the requirements in Part 2.1.2.a.iii. to describe the erosion and sediment controls you will use to achieve an equivalent sediment reduction, as described in Part D.2.2 below). Note that you must also show any buffers on your site plan in your SWPPP consistent with Part 7.2.6.c. Additionally, if any disturbances related to the exceptions in Part 2.1.2.a.v. occur within the buffer area, you must document this in the SWPPP.

D.2.2 Guidance for Providing the Equivalent Sediment Reduction as the 50-foot Buffer.

If you are selecting Alternative 2 (provide and maintain a buffer that is less than 50 feet that is supplemented by additional erosion and sediment controls that, together, achieve the equivalent sediment load reduction as the 50-foot buffer) or Alternative 3 (implement erosion and sediment controls that achieve the equivalent sediment load reduction as the 50-foot buffer), the following guidance is intended to assist you in demonstrating that you will achieve the equivalent sediment reduction as the 50-foot buffer.

D.2.2.1 Determine Whether it is Feasible to Provide a Reduced Buffer.

DWQ recognizes that there will be a number of situations in which it will be infeasible to provide and maintain a buffer of any width. While some of these situations may exempt you from the buffer requirement entirely (see D.1.2), if you do not qualify for one of these exemptions, there still may be conditions or circumstances at your site that make it infeasible to provide a natural buffer. For example, there may be sites where a significant portion of the property on which the earth-disturbing activities will occur is located within the buffer area, thereby precluding the retention of natural buffer areas. DWQ believes there are likely to be other examples of situations that make it infeasible to provide any buffer area.

Therefore, in choosing between the 2 different compliance alternatives (Alternative 2 or 3), you should only elect to comply with Alternative 2 if it is feasible for you to retain any natural buffer on your site. (Note: For any buffer width retained, you are required to comply with the requirements in Part D.2.1, above, concerning the retention of vegetation and restricting earth disturbances.) Similarly, if you determine that it is infeasible to provide a natural buffer of any size during construction, you should elect to comply with Alternative 3. After making this determination, you should proceed to Part D.2.2.2 to determine how to provide controls that, together with any buffer areas that is being retained, if applicable, will achieve an equivalent sediment load reduction as the 50-foot buffer.

D.2.2.2 Design Controls That Provide Equivalent Sediment Reduction as 50-foot Buffer



You must next determine what additional controls must be implemented on your site that, alone or in combination with any retained natural buffer, achieve a reduction in sediment equivalent to that achieved by a 50-foot buffer.

Note that if only a portion of the natural buffer is less than 50 feet, you are only required to implement erosion and sediment controls that achieve the sediment load reduction equivalent to the 50-foot buffer for discharges through that area. You would not be required to provide treatment of storm water discharges that flow through 50 feet or more of natural buffer. See Figure D - 4.

Figure D - 4 Example of how to comply with the requirement to provide the equivalent sediment reduction when only a portion of your earth-disturbances discharge to a buffer of less than 50-feet.

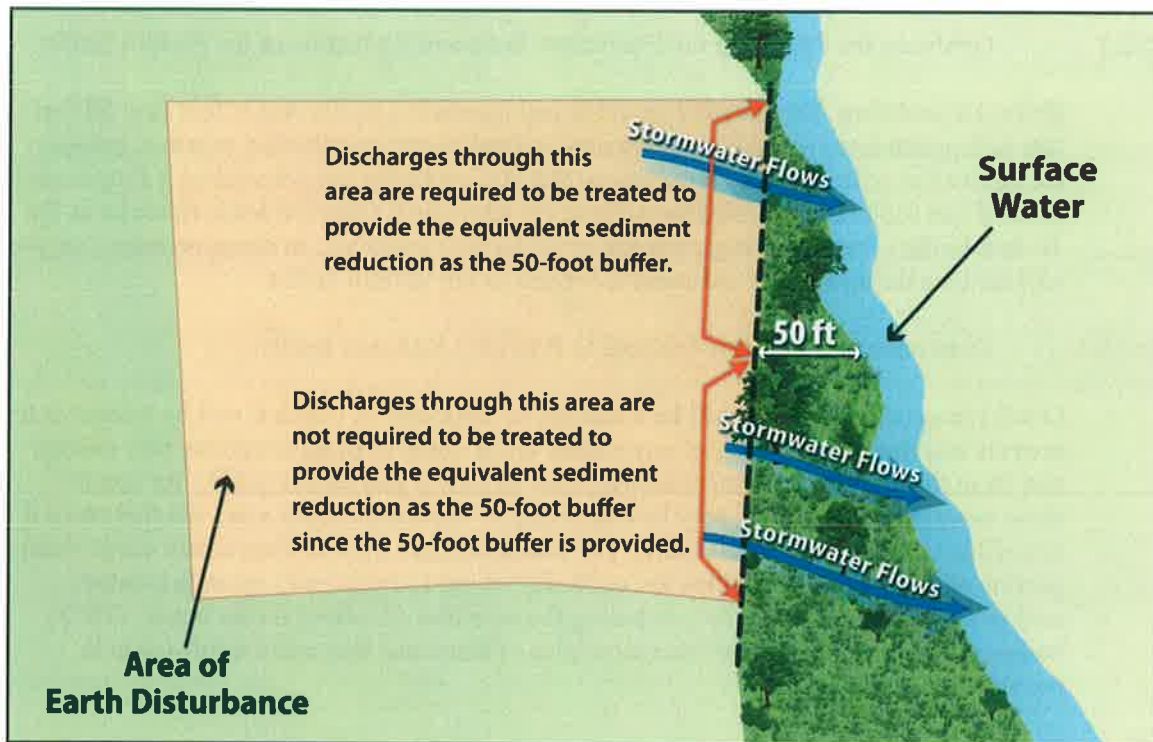

To comply with this requirement, you are required to do the following:

Step 1 - Estimate the sediment reduction expected from your site if you had retained a 50-foot natural buffer;

Step 2 - Design controls that alone or in combination with any width of buffer retained achieve the equivalent sediment removal efficiency as that expected from the 50-foot buffer; and

Step 3 - Document in your SWPPP how your controls will achieve the equivalent sediment removal efficiency of the 50-foot buffer.

Guidelines to help you work through these requirements are provided below.

a. Step 1 - Estimate the Sediment Reduction from the 50-foot Buffer

In order to design controls that match the sediment removal efficiency of a 50-foot buffer, you first need to know what this efficiency is for your site. The sediment removal efficiencies of natural buffers vary according to a number of site-specific factors, including precipitation, soil type, land cover, slope length, width, steepness, and the types of sediment controls used to reduce the discharge of sediment prior to the buffer. DWQ has adopted EPA calculations concerning this and DWQ has adapted it to Utah. EPA has simplified this calculation by developing buffer performance tables covering a range of vegetation and soil types for the areas in Utah. See Attachment , Tables D – 4 and D - 5. Note: buffer performance values in Tables D – 4 and D - 5 represent the percent of sediment captured through the use of perimeter controls (e.g., silt fences) and 50-foot buffers at disturbed sites of fixed proportions and slopes.<sup>2</sup>

Using Tables D – 4 and D - 5 (see Attachment 1), you can determine the sediment removal efficiency of a 50-foot buffer for your geographic area by matching the vegetative cover type that best describes your buffer area and the type of soils that predominate at your site. For example, if your site is located in moist Utah (see the 3-zone precipitation map of Utah in Appendix F), Table D - 4, and your buffer vegetation corresponds most closely with that of medium density weeds, and the soil type at your site is best typified as sand, your site's sediment removal efficiency would be 28 percent. In this step, you should choose the vegetation type

---

<sup>2</sup> EPA used the following when developing the buffer performance tables:

- The sediment removal efficiencies are based on the U.S. Department of Agriculture's RUSLE2 ("Revised Universal Soil Loss Equation 2") model for slope profiles using a 100-foot long denuded slopes.
- Sediment removal was defined as the annual sediment delivered at the downstream end of the 50-foot natural buffer (tons/yr/acre) divided by the annual yield from denuded area (tons/yr/acre).
- As perimeter controls are also required by the CGP, sediment removal is in part a function of the reduction due to a perimeter control (i.e., silt fence) located between the disturbed portion of the site and the upstream edge of the natural buffer and flow traveling through a 50-foot buffer of undisturbed natural vegetation.
- It was assumed that construction sites have a relatively uniform slope without topographic features that accelerate the concentration for erosive flows.
- It was assumed that vegetation has been removed from the disturbed portion of the site and a combination of cuts and fills have resulted in a smooth soil surface with limited retention of near-surface root mass

To represent the influence of soil, EPA analyzed 11 general soil texture classifications in its evaluation of buffer performance. To represent different types of buffer vegetation, EPA evaluated 4 or more common vegetative types for each state/territory covered under the permit (DWQ is using only that which is approximately what could be found in Utah or nearby areas). For each vegetation type evaluated, EPA considered only permanent, non-grazed and non-harvested vegetation, on the assumption that a natural buffer adjacent to the surface water will typically be undisturbed. EPA also evaluated slope steepness and found that sediment removal efficiencies present in Tables D -4 and D - 5 are achievable for slopes that are less than nine percent.

in the tables that most closely matches the vegetation that would exist naturally in the buffer area on your site regardless of the condition of the buffer. However, because you are not required to plant any additional vegetation in the buffer area, in determining what controls are necessary to meet this sediment removal equivalency in Step 2 below, you will be able to take credit for this area as a fully vegetated “natural buffer.” Similarly, if a portion of the buffer area adjacent to the surface water is owned by another party and is not under your control, you can treat the area of land not under control as having the equivalent vegetative cover and soil type that predominates on the portion of the property on which your construction activities are occurring.

For example, if your earth-disturbances occur within 50 feet of a surface water, but the 10 feet of land immediately adjacent to the surface water is owned by a different party than the land on which your construction activities are taking place and you do not have control over that land, you can treat the 10 foot area adjacent to the stream as having the equivalent soil and vegetation type as predominates in the 40 foot area under your control. You would then make the same assumption in Step 2 for purposes of determining the equivalent sediment removal.

Alternatively, you may do your own calculation of the effectiveness of the 50-foot buffer based upon your site-specific conditions, and may use this number as your sediment removal equivalency standard to meet instead of using Tables D – 4 and D - 5. This calculation must be documented in your SWPPP.

b. Step 2 - Design Controls That Match the Sediment Removal Efficiency of the 50-foot Buffer

Once you have determined the estimated sediment removal efficiency of a 50-foot buffer for your site in Step 1, you will be required to select storm water controls that will provide an equivalent sediment load reductions. These controls can include the installation of a single designed control, such as a sediment pond, additional perimeter controls, or other type of device. Alternatively, you may elect to install a combination of storm water controls and to retain some amount of a buffer. Whichever control(s) you select, you must demonstrate in your SWPPP that the controls will provide at a minimum the same sediment removal capabilities as the 50-foot buffer (Step 1). You are allowed to take credit for the removal efficiencies of your required perimeter controls in your calculation of equivalency, because these were included in calculating the buffer removal efficiencies in tables D – 4 and D - 5. (Note: You are reminded that the controls must be kept in effective operating condition until you have completed final stabilization on the disturbed portions of the site discharging to the surface water.)

To make the determination that your controls and/or buffer area achieve an equivalent sediment load reduction as the 50-foot buffer, you will need to use a model or other type of calculator. As mentioned above, there are a variety of models available that can be used to support your calculation, including USDA’s RUSLE-series programs and the WEPP erosion model, SEDCAD, SEDIMOT, or other models. A couple of examples are provided in Attachment 3 to help illustrate how this determination could be made. If you are retaining a buffer of less than 50 feet, you may take credit for the removal that will occur from the reduced buffer



and only need to provide additional controls to make up the difference between the removal efficiency of a 50 foot buffer and the removal efficiency of the narrower buffer. For example, if you are retaining a 30 foot buffer, you can account for the sediment removal provided by the 30-foot buffer retained, and you will only need to design controls to make up for the additional removal provided by the 20-foot of buffer that is not being provided. To do this, you would plug the width of the buffer that is retained into RUSLE or another model, along with other storm water controls that will together achieve a sediment reduction equivalent to a natural 50-foot buffer. As described in Step 1 above, you can take credit for the area you have retained as a “natural buffer” as being fully vegetated, regardless of the condition of the buffer area.

For example, if your earth-disturbances occur 30 feet from a surface water, but the 10 feet of land immediately adjacent to the surface water is owned by a different party than the land on which your construction activities are taking place and you do not have control over that land, you can treat the 10-foot area as a natural buffer, regardless of the activities that are taking place in the area. Therefore, you can assume (for purposes of your equivalency calculation) that your site is providing the sediment removal equivalent of a 30-foot buffer, and you will only need to design controls to make up for the additional removal provided by the 20-foot of buffer that is not being provided.

c. Step 3 - Document How Site-Specific Controls Will Achieve the Sediment Removal Efficiency of the 50-foot Buffer

In Steps 1 and 2, you determined both the expected sediment removal efficiency of a 50-foot buffer at your site, and you used this number as a performance standard to design controls to be installed at your site, which alone or in combination with any retained natural buffer, achieves the expected sediment removal efficiency of a 50-foot buffer at your site. The final step is to document in your SWPPP the information you relied on to calculate the equivalent sediment reduction as an undisturbed natural buffer. DWQ will consider your documentation to be sufficient if it generally meets the following:

- For Step 1, refer to the table in Attachment 1 that you used to derive your estimated 50-foot buffer sediment removal efficiency performance. Include information about the buffer vegetation and soil type that predominate at your site, which you used to select the sediment load reduction value in Tables D - 4 and D - 5. Or, if you conducted a site-specific calculation for sediment removal efficiency, provide the specific removal efficiency, and the information you relied on to make your site-specific calculation.
- For Step 2: (1) Specify the model you used to estimate sediment load reductions from your site; and (2) the results of calculations showing how your controls will meet or exceed the sediment removal efficiency from Step 1.

If you choose Alternative 3, you must also include in your SWPPP a description of why it is infeasible for you to provide and maintain an undisturbed natural buffer of any size.

D.2.3 Small Residential Lot Compliance Alternatives

In this part of Appendix D, EPA provides additional compliance alternatives for owner/operators of small residential lots. In accordance with Part 2.1.2.a.v.4), owner/operators of small residential lots who do not provide a 50-foot buffer are not required to make the demonstration outlined in Part D.2.2.2. Instead,

A small residential lot is a lot or grouping of lots being developed for residential purposes that will disturb less than 1 acre of land, but that is part of a larger residential project that will ultimately disturb greater than or equal to 1 acre.

qualifying owner/operators can comply with the buffer requirement by choosing to implement a set of traditional sediment and erosion controls from the menu of practices provided in Part D.2.3.2. DWQ allows the (EPA developed) two different alternatives for compliance. The following steps describe how a small residential lot owner/operator would achieve compliance with these 2 alternatives.

D.2.3.1 Step 1 – Determine if You are Eligible for the Small Residential Lot Compliance Alternatives

In order to be eligible for the small residential lot compliance alternatives, the following conditions must be met:

- a. The lot or grouping of lots meets the definition of “small residential lot”; and
- b. The owner/operator must comply with all other requirements in Part 2.1.2.a, including:
  - i. Ensure that all discharges from the area of earth disturbance to the natural buffer are first treated by the site’s erosion and sediment controls, and use velocity dissipation devices if necessary to prevent erosion caused by storm water within the buffer;
  - ii. Document in the SWPPP the natural buffer width retained on the property, and show the buffer boundary on your site plan; and
  - iii. Delineate, and clearly mark off, with flags, tape, or other similar marking device, all natural buffer areas.

D.2.3.2 Step 2 – Implement the Requirements of the Small Residential Lot Compliance Alternative Selected

You must next choose from one of two small residential lot compliance alternatives and implement the storm water control practices associated with that alternative.

**Note:** *The compliance alternatives provided below are not mandatory. Owner/Operators of small residential lots can alternatively choose to comply with the any of the options that are available to other sites in Part 2.1.2.a.i, described in Parts D.2.1 and D.2.2 in this appendix.*

**a. Small Residential Lot Compliance Alternative 1**

Alternative 1 is a straightforward tiered- technology approach that specifies the controls that a small residential lot must implement based on the buffer width retained. To achieve compliance with Alternative 1, you must implement the controls specified in Table D – 1 based on the buffer width to be retained. See footnote 3, below, for a description of the controls you must implement.

For example, if you are an owner/operator of a small residential lot that will be retaining a 35-foot buffer and you choose Small Residential Lot Compliance Alternative 1, you must implement double perimeter controls between earth disturbances and the surface water.

In addition to implementing the applicable control, you must also document in your SWPPP how you will comply with Alternative 1.

Table D - 1. Alternative 1 Requirements<sup>3</sup>

Retain 50-foot Buffer	Retain <50 and >30 foot Buffer	Retain ≤ 30 foot Buffer
No Additional Requirements	Double Perimeter Controls	Double Perimeter Controls and 7-Day Site Stabilization

**b. Small Residential Lot Compliance Alternative 2**

Alternative 2 specifies the controls that a builder of a small lot must implement based on both the buffer width retained and their risk of sediment discharge. By incorporating the sediment risk, this approach may result in the implementation of controls that are more appropriate for the site’s specific conditions.

**Step 1 – Determine Your Site’s Sediment Risk Level**

To meet the requirements of Alternative 2, you must first determine your site’s sediment discharge “risk level” based on the site’s slope, location, and soil type. To help you to determine your site’s sediment risk level, DWQ has adapted table D-2 for areas from moist Utah, semi-arid, or arid; soil type; and different slope conditions. On table D-2, first select the slope; then select the climate (moist, semi-arid, or arid); then select the soil type.

<sup>3</sup> Description of Additional Controls Applicable to Small Residential Lot Compliance Alternatives 1 and 2:

- **No Additional Requirements:** If you implement a buffer of 50 feet or greater, then you are not subject to any additional requirements. Note that you are required to install perimeter controls between the disturbed portions of your site and the buffer in accordance with Part 2.1.2.b.
- **Double Perimeter Control:** In addition to the reduced buffer width retained on your site, you must provide a double row of perimeter controls between the disturbed portion of your site and the surface water spaced a minimum of 5 feet apart.
- **Double Perimeter Control and 7-Day Site Stabilization:** In addition to the reduced buffer width retained on your site and the perimeter control implemented in accordance with Part 2.1.2.b, you must provide a double row of perimeter controls between the disturbed portion of your site and the surface water spaced a minimum of 5 feet apart, and you are required to complete the stabilization activities specified in Parts 2.2.1.b.i or 2.2.2.b within 7 calendar days (in place of what is normally required) of the temporary or permanent cessation of earth-disturbing activities.

All moist and semi-arid risks are low for all soil types. The only moderate risk is arid at 9 % slope to 15 % slope for 3 categories of soil; and arid for loam, silt, sandy loam, or silt loam for all slopes over 3%. The only times for concern of a risk over “low” is when the slope is over 9%, or when the soil is loam, silt, sandy loam, or silt loam.

If you have a site in moist or semi-arid Utah, the risk will always be low. If you have a site in arid Utah where the slope is 5% and the soil is sandy, your risk is “moderate”. After you determine the “risk level” (e.g., “low”, “moderate”, or “high”) that corresponds to your site’s location and predominant soil type<sup>4</sup> you determine the controls you must apply.

Table D - 2. Risk Levels for Sites Based on the 3-Zone Precipitation Map for Utah (see Appendix F)

Soil Type Location	Clay	Silty Clay, Loam, or Clay- Loam	Sand	Sandy Clay, Loam, Loamy Sand, or Silty Clay	Loam, Silt, Sandy Loam, or Silt Loam	
Moist & Semi-Arid	Low	Low	Low	Low	Low	Risk Levels for Sites with Average Slopes of ≤ 3 Percent
Arid	Low	Low	Low	Low	Low	
Moist & Semi-Arid	Low	Low	Low	Low	Low	Risk Levels for Sites with Average Slopes of > 3 Percent and ≤ 6 Percent
Arid	Low	Low	Low	Low	Moderate	
Moist & Semi-Arid	Low	Low	Low	Low	Low	Risk Levels for Sites with Average Slopes of > 6 Percent and ≤ 9 Percent
Arid	Low	Low	Low	Low	Moderate	
Moist & Semi-Arid	Low	Low	Low	Low	Low	Risk Levels for Sites with Average Slopes of > 9 Percent and ≤ 15 Percent
Arid	Low	Moderate	Low	Moderate	Moderate	

Step 2 – Determine Which Additional Controls Apply

Once you determine your site’s “risk level”, you must next determine the additional controls you need to implement on your site, based on the width of buffer you plan

<sup>4</sup> One source for determining your site’s predominant soil type is the USDA’s Web Soil Survey located at <http://websoilsurvey.nrcs.usda.gov/app/WebSoilSurvey.aspx>.

to retain. Table D - 3 specifies the requirements that apply based on the “risk level” and buffer width retained. See footnote 3, above, for a description of the additional controls that are required.

For example, if you are the owner/operator of a small residential lot that falls into the “moderate” risk level, and you decide to retain a 20-foot buffer, using Table D-3 you would determine that you need to implement double perimeter controls to achieve compliance with Part 2.1.2.a.

You must also document in your SWPPP your compliance with Alternative 2.

Table D - 3. Alternative 2 Requirements<sup>2</sup>

Risk Level Based on Estimated Soil Erosion	Retain ≥ 50' Buffer	Retain <50' and >30' Buffer	Retain ≤30' and >10' Buffer	Retain ≤ 10' Buffer
Low Risk	No Additional Requirements	No Additional Requirements	Double Perimeter Control	Double Perimeter Control
Moderate Risk	No Additional Requirements	Double Perimeter Control	Double Perimeter Control	Double Perimeter Control and 7-Day Site Stabilization
High Risk	No Additional Requirements	Double Perimeter Control	Double Perimeter Control and 7-Day Site Stabilization	Double Perimeter Control and 7-Day Site Stabilization

## ATTACHMENT 1

Sediment Removal Efficiency Tables<sup>5</sup>

EPA recognizes that very high removal efficiencies, even where theoretically achievable by a 50-foot buffer, may be very difficult to achieve in practice using alternative controls. Therefore in the tables below, EPA has limited the removal efficiencies to a maximum of 90%. Efficiencies that were calculated at greater than 90% are shown as 90%, and this is the minimum percent removal that must be achieved by alternative controls.

## D-4. Estimated 50-foot Buffer Performance in Semi-Arid and Moist Areas\*

Type of Buffer vegetation**	Estimated % Sediment Removal				
	Clay	Silty Clay Loam or Clay-Loam	Sand	Sandy Clay Loam, Loamy Sand or Silty Clay	Loam, Silt, Sandy Loam or Silt Loam
Tall Fescue Grass	42	52	44	48	85
Medium-density Weeds	28	30	28	26	60
Low-density Warm-season Native Bunch Grass (i.e., Grama Grass)	25	26	24	24	55
Northern Mixed Prairie Grass	28	30	28	26	50
Northern Range Cold Desert Shrubs	28	28	24	26	50

\*Applicable for sites with less than nine percent slope.

\*\*Characterization focuses on the under-story vegetation

## D-5. Estimated 50-foot Buffer Performance in Arid Areas\*

Type of Buffer vegetation**	Estimated % Sediment Removal				
	Clay	Silty Clay Loam or Clay-Loam	Sand	Sandy Clay Loam, Loamy Sand or Silty Clay	Loam, Silt, Sandy Loam or Silt Loam
Tall Fescue Grass	71	85	80	86	90
Medium-density Weeds	56	73	55	66	78
Low-density Warm-season Native Bunch Grass (i.e., Grama Grass)	53	70	51	62	67
Southern Mixed Prairie Grass	53	71	52	63	50
Southern Range Cold Desert Shrubs	56	73	55	65	53

\*Applicable for sites with less than nine percent slope.

\*\*Characterization focuses on the under-story vegetation

<sup>5</sup> The buffer performances were calculated based on a denuded slope upgradient of a 50-foot buffer and perimeter controls, as perimeter controls are a standard requirement (see Part 2.1.2.b).

ATTACHMENT 2

Using the Sediment Removal Efficiency Tables – Questions and Answers

- What if my specific buffer vegetation is not represented in Tables D – 4, and D- 5. If you do not see a description of the type of vegetation present at your site, you should choose the vegetation type that most closely matches the vegetation type on your site. You can contact your local Cooperative Extension Service Office ([www.csrees.usda.gov/Extension](http://www.csrees.usda.gov/Extension)) for assistance in determining the vegetation types that most closely matches your site-specific vegetation.
- What if there is high variability in local soils? EPA recognizes that there may be a number of different soil type(s) on any given construction site. General soil information can be obtained from USDA soil survey reports (<http://websoilsurvey.nrcs.usda.gov>) or from individual site assessments performed by a certified soil expert. Tables D- 4 through D- 5 present eleven generic soil texture classes, grouping individual textures where EPA has determined that performance is similar. If your site contains different soil texture classes, you should use the soil type that best approximates the predominant soil type at your site.
- What if my site slope is greater than 9 percent after final grade is reached? As indicated in the buffer performance tables, the estimated sediment removal efficiencies are associated with disturbed slopes of up to 9 percent grade. Where your graded site has an average slope of greater than 9 percent, you should calculate a site-specific buffer performance.
- How do I calculate my own estimates for sediment reduction at my specific site? If you determine that it is necessary to calculate your own sediment removal efficiency using site specific conditions (e.g., slopes at your site are greater than 9 percent), you can do so by choosing from a range of available mathematical models that are available to facilitate this calculation, including USDA's RUSLE-series programs and the WEPP erosion model, SEDCAD, SEDIMOT, or other equivalent models.
- What is my estimated buffer performance if my site location is not represented by Tables D-4 through D-5? If your site is located in an area not represented by Tables D-4 through D-5, you should use the table that most closely approximates conditions at your site. You may also choose to conduct a site-specific calculation of the buffer performance.
- What if only a portion of my site drains to the buffer area? If only a portion of your site drains to a surface water, where that water is within 50 feet of your construction activities, you are only required to meet the equivalency requirement for the storm water flows corresponding to those portions of the site. See Example 2 below for an example of how this is expected to work.

ATTACHMENT 3

Examples of How to Use the Sediment Removal Efficiency Tables

Example 1. Comparatively Wet Location (7.5 acre site located in Moist Utah)

The operator of a 7.5-acre construction site in Moist Utah has determined that it is infeasible to establish a buffer of any size on their site, and is now required to select and install controls that will achieve an equivalent sediment load reduction as that estimated in Table D- 4 for their site conditions. The first step is to identify what percentage of eroded sediment is estimated to be retained from a 50-foot buffer. For this example, it is assumed that the site has a relatively uniform gentle slope (3 percent), so Table D- 4 can be used to estimate the 50-foot buffer sediment load reduction. If the site's buffer vegetation is best typified by northern mix prairie grass and the underlying soil is of a type best described as loamy sand, the 50-foot buffer is projected to capture 26 percent of eroded sediment from the construction site.

The second step is to determine what sediment controls can be selected and installed in combination with the perimeter controls already required to be implemented at the site (see Part 2.1.2.b), which will achieve the 26 percent sediment removal efficiency from Table D- 4. For this example, using the RUSLE2 profile model, it was determined that installing a pair of shallow sloped diversion ditches to convey runoff to a well-designed and maintained sediment basin provides 99 percent sediment removal. Because the estimated sediment reduction is greater than the required 26 percent that a 50-foot buffer provides, the operator will have met the buffer requirements. See Figure D- 5. The operator could also choose a different set of controls, as long as they achieve at least a 90 percent sediment removal efficiency.



Figure D- 5. Example 1 – Equivalent Sediment Load Reductions at a 7.5 ac Site in moist Utah.

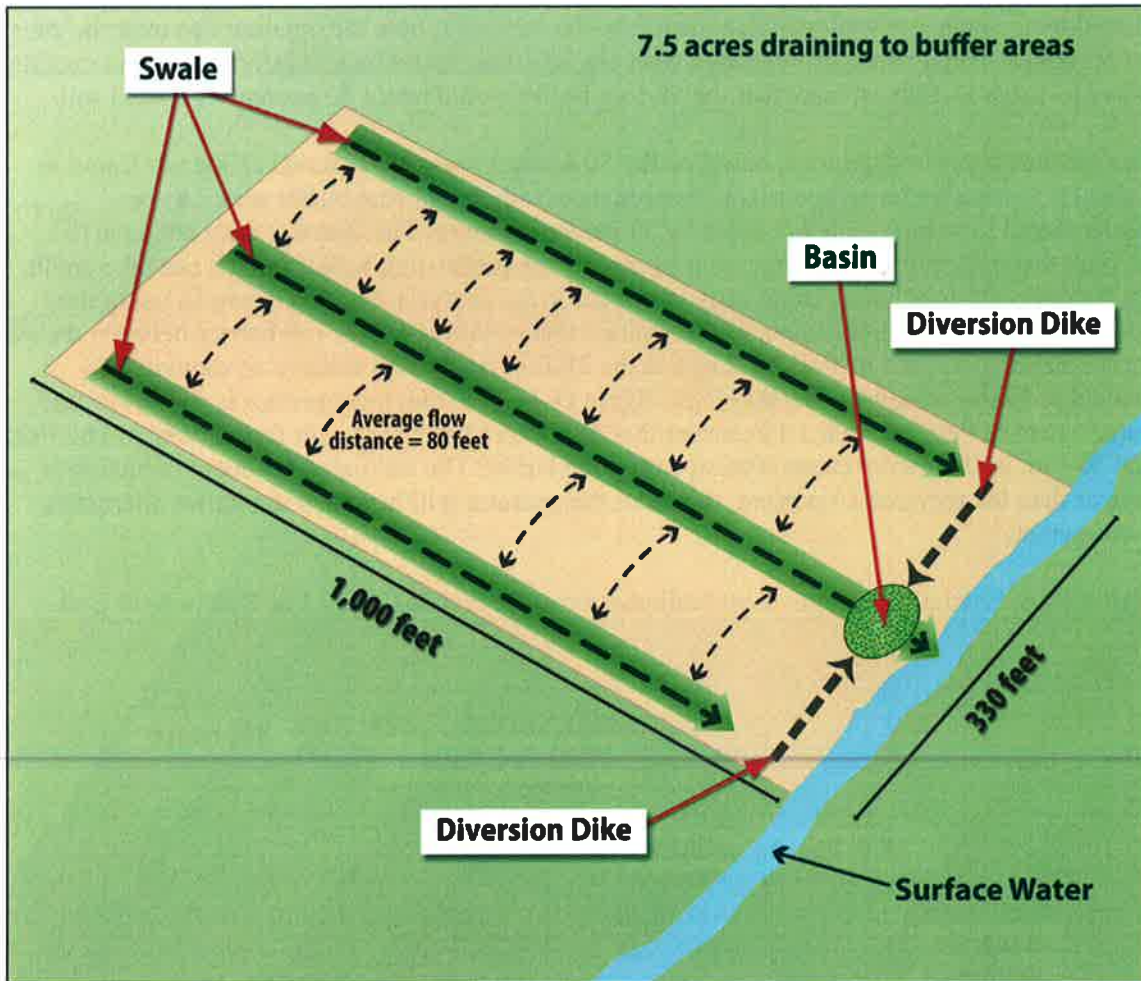

Example 2. Arid Location With Pre-existing Disturbances in the Natural Buffer (6.5 acre site located in Arid Utah)

An operator of a site in Arid Utah determines that it is not practicable to provide a 50-foot buffer, but a 28-foot buffer can be provided. Because the operator will provide a buffer that is less than 50 feet, the operator must determine which controls, in combination with the 28-foot buffer, achieve a sediment load reduction equivalent to the 50-foot buffer. In this example, the project will disturb 6.5 acres of land, but only 1.5 acres of the total disturbed area drains to the buffer area. Within the 28-foot buffer area is a preexisting concrete walkway. Similar to Example 1, the equivalence analysis starts with Step 1 (Part D.2.2.b) with a review of the Arid Utah buffer performance (Table D- 5). The operator determines that the predominate vegetation type in the

buffer area is prairie grass and the soil type is similar to silt, and that the site is of a uniform, shallow slope (e.g., 3 percent grade). Although the operator will take credit for the disturbance caused by the concrete walkway as a natural buffer in Step 2, here the operator can treat the entire buffer area as being naturally vegetated with prairie grass. Based on this information, the operator refers to Table D- 5 to estimate that the 50-foot buffer would retain 50 percent of eroded soil.

The second step is to determine, based on the 50 percent sediment removal efficiency found in Table D- 5, what sediment controls in combination with the 28-foot buffer area, can be implemented to reduce sediment loads by 50 percent or more. The operator does not have to account the reduction in buffer function caused by the preexisting walkway, and can take credit for the entire 28-foot buffer being fully vegetated in the analysis. For this example, using the RUSLE2 profile model, the operator determined that installing a fiber roll barrier between the silt fence (already required by Part 2.1.2.b) and the 28-foot buffer will achieve an estimated 84 percent sediment removal efficiency. See Figure D- 6. Note that this operator is subject to the requirement in Part 2.1.2.a.ii.1.) to ensure that discharges through the silt fence, fiber roll barrier, and 28-foot buffer do not cause erosion within the buffer. The estimated sediment reduction is greater than the required 50 percent; therefore the operator will have met the buffer alternative requirement.

Figure D- 6. Example 2 – Equivalent Sediment Load Reductions at a 6.5 ac Site in Arid Utah.

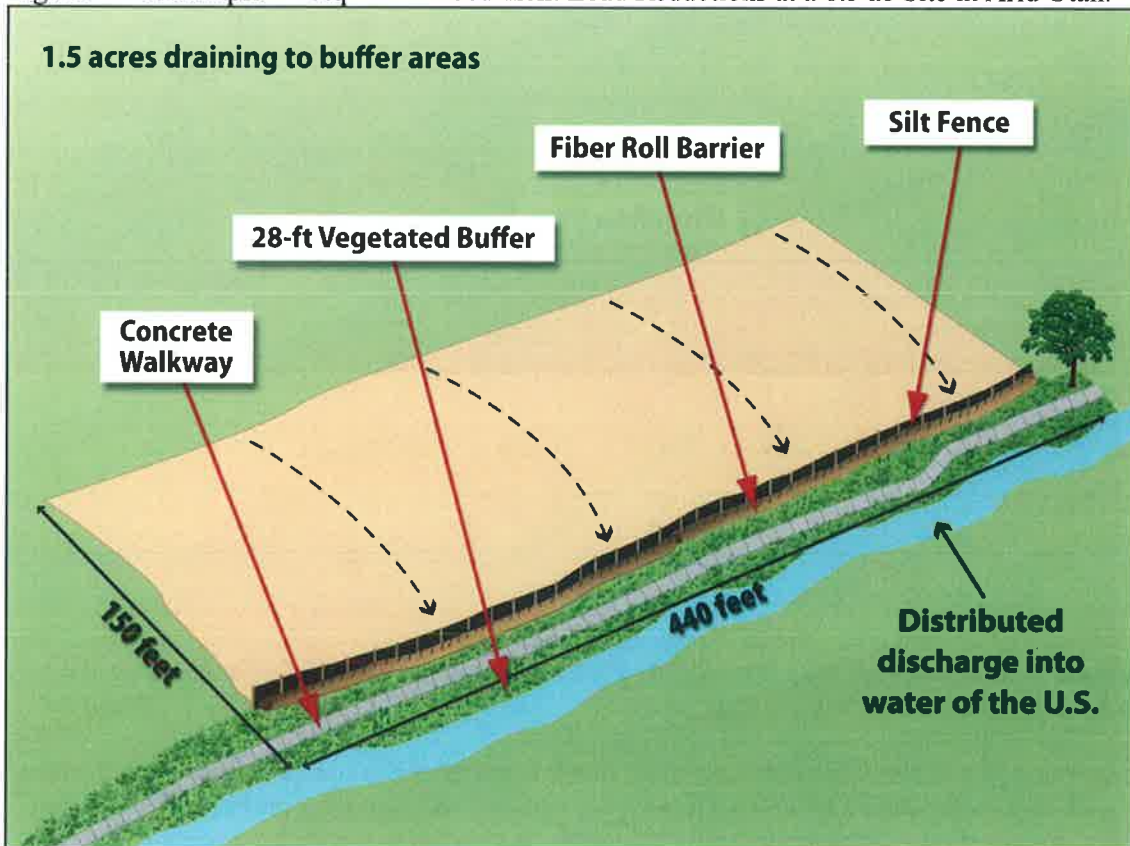

## Appendix E – List of MS4s with Municipal Storm Water Permits

(This appendix is not included in the public notice review as it is for help and assistance to aid compliance and is not regulatory in nature. It may be modified during the term of the permit if the list of MS4s change during the permit term.) The MS4s listed below are regulated by a municipal storm water permit. Under the municipal storm water permit they are required to regulate construction activity in their areas. Areas that are not covered by the MS4s listed below are directly regulated by DWQ.

Alpine	Providence
American Fork	Provo
Bluffdale	River Heights
Bountiful	Riverdale
Cedar Hills	Riverton
Centerville	Roy
Clearfield	Salt Lake City
Clinton	Salt Lake County (unincorporated area)
Cottonwood Heights	Sandy
Davis County (unincorporated area)	Santa Clara
Draper	Smithfield
Farmington	South Jordan
Farr West City	South Ogden City
Fruit Heights	South Salt Lake
Harrisville	South Weber
Herriman	Springville
Highland	St. George
Hill Air Force	Sunset
Holladay	Syracuse
Hooper	Taylorsville
Hyde Park	UDOT
Hyrum City	Uintah City
Ivins City	University of Utah
Kaysville	Utah State Prison
Layton	Veterans Affairs Medical Center
Lehi	Washington
Lindon	Washington Terrace
Logan	Weber County (unincorporated area)
Mapleton	Weber State University
Marriott-Slaterville	Wellsville
Midvale	West Bountiful
Millville	West Haven
Murray	West Jordan
Nibley	West Point City
North Logan City	West Valley City
North Ogden	Woods Cross
North Salt Lake	
Ogden	
Orem	
Plain City	
Pleasant Grove	
Pleasant View	

Appendix F – 2-Year, 24-Hour Storm Frequencies in Utah  
Average Annual Rainfall in Utah  
3 Zone Precipitation Map for Utah

(See next page)

(This appendix is not included in the public notice review as it is for help and assistance to aid compliance and is not regulatory in nature. It may be modified during the term of the permit if it is found that it can be improved on.)



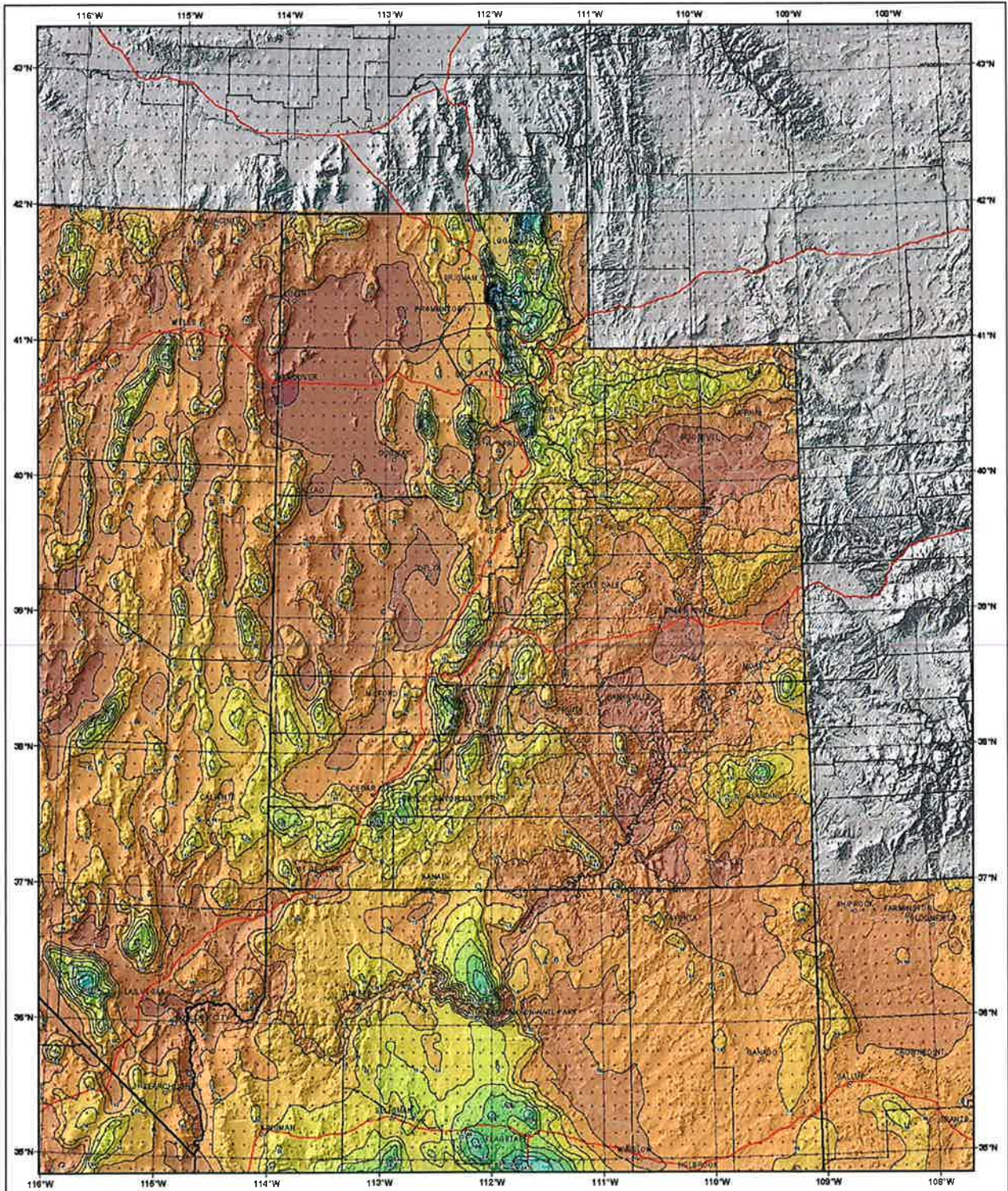

**UTAH**

NOAA Atlas 14, Volume 1, Version 5  
 Semiarid Southwestern United States

Prepared by U.S. DEPARTMENT OF COMMERCE  
 NATIONAL OCEANIC AND ATMOSPHERIC ADMINISTRATION  
 NATIONAL WEATHER SERVICE  
 OFFICE OF HYDROLOGIC DEVELOPMENT  
 HYDROMETEOROLOGICAL DESIGN STUDIES CENTER  
 June 2006

SCALE 1:2,000,000  
 (As shown on map at NAD 83 datum)  
 0 10 20 30 40 50 Miles  
 0 5 10 20 30 40 50 Kilometers

**Isopluivals of 24 hour precipitation (inches)  
 with Average Recurrence Interval of 2 years**

See NOAA Atlas 14 documentation for factors to  
 convert to Annual Exceedance Probabilities for  
 all estimates below 25 years



**Inches**

0.61 - 0.80	1.41 - 1.60	2.21 - 2.40	3.01 - 3.50	5.01 - 5.50
0.91 - 1.00	1.61 - 1.80	2.41 - 2.60	3.51 - 4.00	5.51 - 6.00
1.01 - 1.20	1.81 - 2.00	2.61 - 2.80	4.01 - 4.50	6.01 - 6.50
1.21 - 1.40	2.01 - 2.20	2.81 - 3.00	4.51 - 5.00	6.51 - 7.00







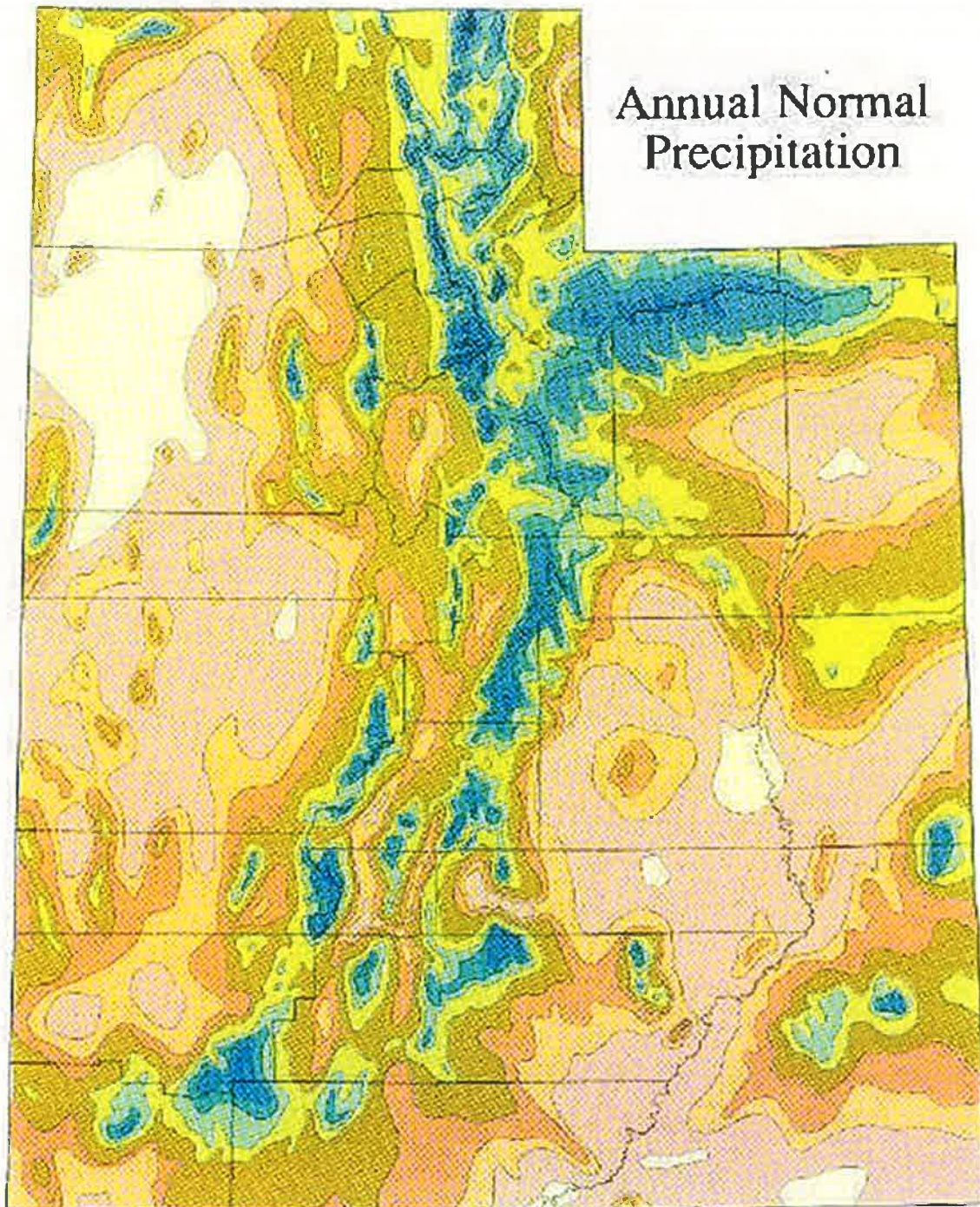



Source: United States Army Corps of Engineers, Hydrologic Engineering Center, 1978



# Annual Normal Precipitation



## Legend Precipitation (In inches)

 more than 49.9	 25.0-29.9	 12.0-15.9	 6.0-7.9
 40.0-49.9	 20.0-24.9	 10.0-11.9	 less than 6
 30.0-39.9	 16.0-19.9	 8.0-9.9	



# Utah: Precipitation Zones

## Average Precipitation (inches)

- < 10 (Arid)
- 10 - 20 (Semi-arid)
- > 20 (Moist)
- County Boundary
- Major Streams
- Lakes



0 20 40 60 80 100 Miles

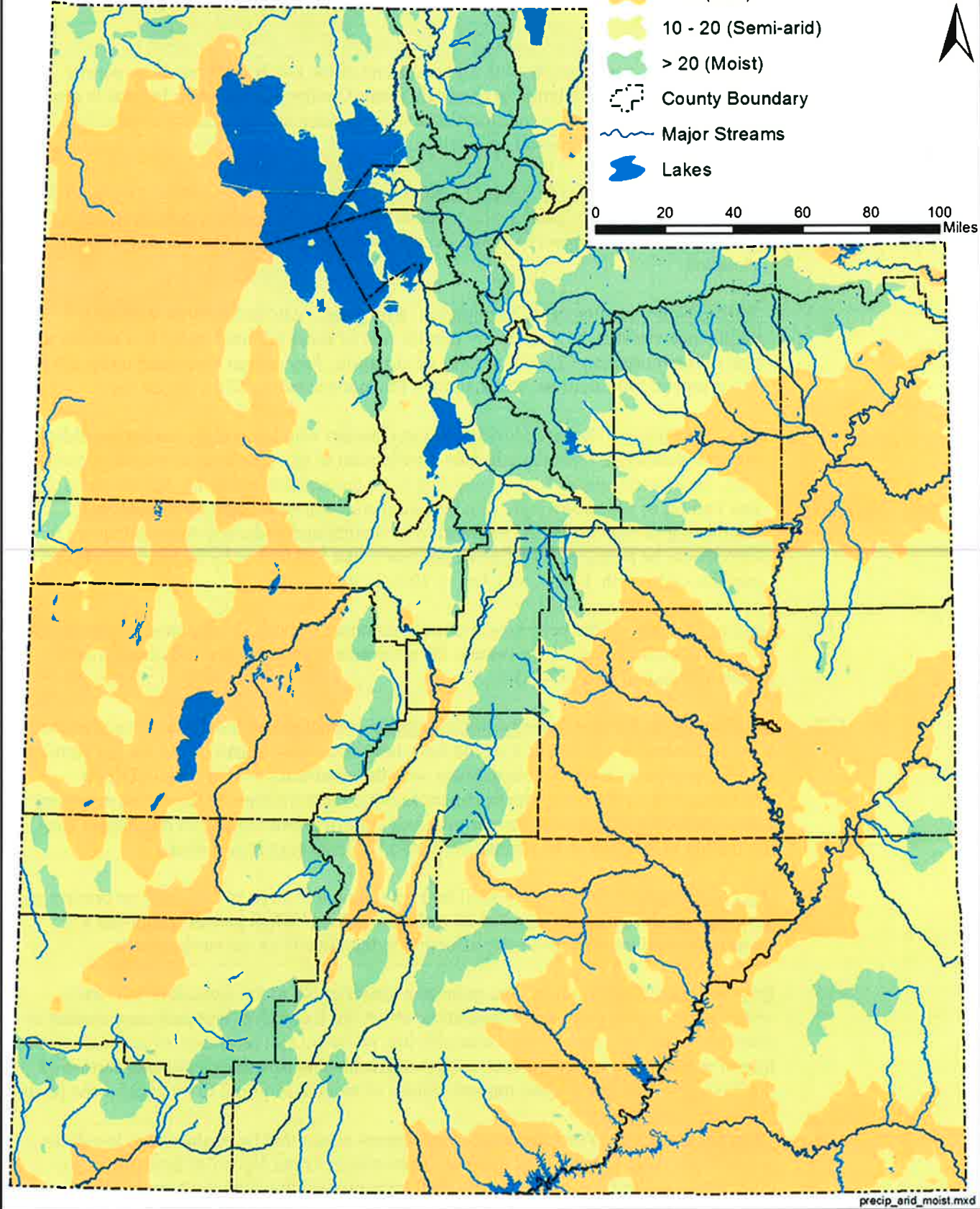

Appendix G – Standard Permit Conditions

- G.1. Duty to Comply.
1. The permittee must comply with all conditions of the UPDES permit. Any permit noncompliance is a violation of the Utah Water Quality Act, as amended and is grounds for enforcement action; permit termination, revocation and reissuance or modification; or denial of a permit renewal application.
  2. Penalties for Violations of Permit Conditions. The Utah Water Quality Act, in 19-5-115, provides that any person who violates the Act, or any permit, rule, or order adopted under it is subject to a civil penalty not to exceed \$10,000 per day of such violation.
  3. Willful Non-Compliance or Negligence. Any person who willfully or with gross negligence violates the Act, or any permit, rule or order adopted under it is subject to a fine of not more than \$25,000 per day of violation. Any person convicted under 19-5-115 a second time shall be punished by a fine not exceeding \$50,000 per day.
  4. False Statements. The Act provides that any person who knowingly makes any false material statement, representation, or certification in any application, record, report, plan, or other document filed or required to be maintained under the Act, the rules, or this Permit, or who knowingly falsifies, tampers with, or renders inaccurate, any monitoring device or method required to be maintained under the Act shall upon conviction, be punished by a fine of not more than \$10,000 or by imprisonment for 6 months, or by both. Utah Code Ann. § 19-5-115(4).
- G.2. Duty to Reapply. If the permittee wishes to continue an activity regulated by this permit after the expiration date of the permit, the permittee shall apply for and obtain a new permit as required in R317-8-3.1
- G.3. Need to Halt or Reduce Activity Not a Defense. It shall not be a defense for a permittee in an enforcement action that it would have been necessary to halt or reduce the permitted activity in order to maintain compliance with the conditions of this permit. (Upon reduction, loss, or failure of the treatment facility, the permittee, to the extent necessary to maintain compliance with the permit, shall control production of all discharges until the facility is restored or an alternative method of treatment is provided.)
- G.4. Duty to Mitigate. The permittee shall take all reasonable steps to minimize or prevent any discharge or sludge use or disposal in violation of the UPDES permit which has a reasonable likelihood of adversely affecting human health or the environment.
- G.5. Duty to Provide Information. The permittee shall furnish to the Executive Secretary, within a reasonable time, any information which the Executive Secretary may request to determine whether cause exists for modifying, revoking and reissuing, or terminating the permit or to determine compliance with this permit. The permittee shall also furnish to the Executive Secretary, upon request, copies of records required to be kept by the permit.
- G.6. Other Information. When the permittee becomes aware that he or she failed to submit any relevant facts or submitted incorrect information in the Notice of Intent or in any other report to the Director, he or she shall promptly submit such facts or information.



- G.7. Oil and Hazardous Substance Liability. Nothing in this Permit shall be construed to preclude the institution of any legal action or relieve the Permittee from any responsibilities, liabilities, or penalties to which the Permittee is or may be subject under the "Act".
- G.8. Property Rights. The issuance of this Permit does not convey any property rights of any sort, nor any exclusive privileges, nor does it authorize any injury to private property nor any invasion of personal rights, nor any infringement of Federal, State or local laws or regulations.
- G.9. Severability. The provisions of this Permit are severable, and if any provision of this Permit, or the application of any provision of this Permit to any circumstance, is held invalid, the application of such provision to other circumstances, and the remainder of this Permit shall not be affected thereby.
- G.10. Records Retention.
1. The Permittee shall retain copies of SWPPPs and all reports required by this Permit, and records of all data used to complete the Notice of Intent to be covered by this Permit, for a period of at least three years from the date that the site is finally stabilized. This period may be extended by request of the Director at any time.
  2. After final stabilization of the construction site is complete, the SWPPP is no longer required to be maintained on site, but may be maintained by the Permittee(s) at its primary headquarters. However, access to the SWPPP will continue as described in Part 3.2.
- G.11. Addresses. All written correspondence under this permit shall be directed to the Division of Water Quality at the following address:
- Department of Environmental Quality  
Division of Water Quality  
195 North 1950 West  
PO Box 144870  
Salt Lake City, Utah 84114-4870
- G.12. State Laws.
1. Nothing in this Permit shall be construed to preclude the institution of any legal action or relieve the Permittee from any responsibilities, liabilities, or penalties established pursuant to any applicable State law or regulation under authority preserved by Utah Code Ann. § 19-5-117.
  2. No condition of this Permit shall release the Permittee from any responsibility or requirements under other environmental statutes or regulations.
- G.13. Proper Operation and Maintenance. The Permittee shall at all times properly operate and maintain all facilities and systems of treatment and control (and related appurtenances) which are installed or used by the Permittee to achieve compliance with the conditions of this Permit and with the requirements of SWPPPs. Proper operation and maintenance also

includes adequate laboratory controls and appropriate quality assurance procedures. Proper operation and maintenance requires the operation of backup or auxiliary facilities or similar systems, installed by a Permittee only when necessary to achieve compliance with the conditions of the Permit.

G.14. Inspection and Entry. The Permittee shall allow, upon presentation of credentials, the Director or an authorized representative:

1. To enter upon the Permittee's premises where a regulated facility or activity is located or conducted, or where records must be kept under the conditions of this Permit;
2. Have access to and copy at reasonable times, any records that must be kept under the conditions of this Permit;
3. Inspect at reasonable times any facilities, equipment (including monitoring and control equipment), practices, or operations regulated or required under this Permit; and
4. Sample or monitor at reasonable times, for the purposes of assuring permit compliance or as otherwise authorized by law, any substances or parameters at any location.

G.15. Reopener Clause.

1. Reopener Due to Water Quality Impacts. If there is evidence indicating that the storm water discharges authorized by this Permit cause, have the reasonable potential to cause or contribute to, a violation of a water quality standard, the discharger may be required to obtain an individual permit or an alternative general permit in accordance with Part 2.3 of this Permit or the Permit may be modified to include different limitations and/or requirements.
2. Reopener Guidelines. Permit modification or revocation will be conducted according to UAC R317-8-5.6 and UAC R317-8-6.2.
3. Permit Actions. This Permit may be modified, revoked and reissued, or terminated for cause. The filing of a request by the Permittee for a Permit modification, revocation and reissuance, or termination, or a notification of planned changes or anticipated noncompliance does not stay any Permit condition.

G.16. Signatory Requirements.

1. All Notices of Intent, SWPPPs, reports, certifications or information submitted to the Executive Secretary, or that this Permit requires to be maintained by the Permittee, shall be signed as follows:

1.1. All Notices of Intent shall be signed as follows:

- 1.1.1. For a corporation: by a responsible corporate officer. For the purpose of this section, a responsible corporate officer means: a president, secretary, treasurer, or vice-president of the corporation in charge of a principal business function, or any other person who performs similar policy or decision-making functions for the corporation; or the manager of one or more manufacturing, production or operating facilities employing more than 250 persons or having gross

## Utah Construction General Permit (UCGP)

annual sales or expenditures exceeding \$25,000,000 (in second-quarter 1980 dollars) if authority to sign documents has been assigned or delegated to the manager in accordance with corporate procedures;

- 1.1.2. For a partnership or sole proprietorship: by a general partner or the proprietor, respectively; or
  - 1.1.3. For a municipality, State, Federal, or other public agency: by either a principal executive officer or ranking elected official. For purposes of this section, a principal executive officer of a Federal agency includes (1) the chief executive officer of the agency, or (2) a senior executive officer having responsibility for the overall operations of a principal geographic unit of the agency (e.g. Regional Administrators of EPA).
- 1.2. All reports required by the Permit and other information requested by the Director or by an authorized representative of the Executive Secretary shall be signed by a person described above or by a duly authorized representative of that person. A person is a duly authorized representative only if:
- 1.2.1. The authorization is made in writing by a person described above and submitted to the Director; and
  - 1.2.2. The authorization specifies either an individual or a position having responsibility for overall operation of the regulated site, facility or activity, such as the position of manager, operator, superintendent, or position of equivalent responsibility or an individual or position having overall responsibility for environmental matters for the company. (A duly authorized representative may thus be either a named individual or any individual occupying a named position).
- 1.3. Certification. Any person signing documents under this Part G.16 shall make the following certification:

*I certify under penalty of law that this document and all attachments were prepared under my direction or supervision in accordance with a system designed to assure that qualified personnel properly gathered and evaluated the information submitted. Based on my inquiry of the person or persons who manage the system, or those persons directly responsible for gathering the information, the information submitted is, to the best of my knowledge and belief true, accurate, and complete. I am aware that there are significant penalties for submitting false information, including the possibility of fine and imprisonment for knowing violations.*

## Utah Construction General Permit (UCGP)

### Appendix H – Notice of Intent Form (NOI)

Please Obtain a copy of the NOI from the DWQ web site at  
<http://www.waterquality.utah.gov/UPDES/stormwatercon.htm>

Appendix I – Notice of Termination (NOT)

Please Obtain a copy of the NOT from the DWQ web site at  
<http://www.waterquality.utah.gov/UPDES/stormwatercon.htm>

## Utah Construction General Permit (UCGP)

### Appendix J – Visual Monitoring Form

(This appendix is not included in the public notice review as it is for help and assistance to aid compliance and is not regulatory in nature. It may be modified during the term of the permit if it is found that it can be improved on.)

VISUAL MONITORING FORM

Project Name: \_\_\_\_\_

Project Location: \_\_\_\_\_

Name of Sample Taker: \_\_\_\_\_

Date \_\_\_\_\_ Time \_\_\_\_\_

Describe the location of where the sample was taken. \_\_\_\_\_

Describe how the sample was collected:

Weather conditions at time of sample taking (circle all that apply):

Snowing Raining Sunny Cloudy Windy Warm Cold Freezing Other \_\_

**COLOR** (Circle the one that apply):

Black Dark Grey Medium Grey Light Grey Dark Chocolate Brown  
Medium Brown Light Brown Tan Yellow Green Other

Comments:

**INTENSITY OF COLOR:** Very Intense Prominent Moderately Perceptible Hardly Perceptible

Comments:

**CLARITY** (Circle the right one):

Totally Opaque   Slightly Translucent   Translucent   Nearly Transparent   Transparent/Clear

**ODOR** (Circle the ones that apply):

Diesel   Gasoline   Petroleum   Solvent   Musty   Sewage   Chlorine

Rotten Egg   Sulfur   No Odor   Noxious   Other \_\_\_\_\_

Comments:

---

---

---

**FLOATING SOLIDS**

Styrofoam beads   sticks/leaves/grass   scum film   floating particles

(Description): \_\_\_\_\_

---

---

**SUSPENDED AND SETTLED SOLIDS** (Description)

---

---

---

**FOAM, OIL, SHEEN OR OTHER OBVIOUS INDICATORS OF POLLUTION**

---

---

---



Utah Construction General Permit (UCGP)

Appendix K – Erosivity Waiver Form

The EPA has a web site that automatically calculates the “R” factor that web site is:  
<http://cfpub1.epa.gov/npdes/stormwater/LEW/lewCalculator.cfm>

# EROSIVITY WAIVER FORM

<b>Owner:</b> _____
Address: _____
City: _____ State: _____ zip: _____
Contact Person: _____ Phone: _____
Email: _____

<b>General Contractor:</b> _____
Address: _____
City: _____ State: _____ zip: _____
Contact Person: _____ Phone: _____
Email: _____

<b>Project Name:</b> _____
Address: _____
City: _____ State: _____ zip: _____

<b>Factors Needed for Calculation of R Factor</b>
Latitude: _____
Longitude: _____
Start Date: _____
End Date: _____
"R" Factor Value: _____
Hand calculated <input type="checkbox"/> EPA calculated <input type="checkbox"/>

<b>The Project Should not Extend Past the End Date</b>
If the project continues beyond the end date submitted in the waiver the owner must recalculate the "R" factor using the new end date. If the new "R" factor is 5 or more the owner must immediately obtain coverage under the UPDES CGP. The waiver should only be used if the owner has confidence the project can be completed within the start and end date submitted in the waiver.

Appendix L – Example Self-Inspection Form

(This appendix is not included in the public notice review as it is for help and assistance to aid compliance and is not regulatory in nature. It may be modified during the term of the permit if it is found that it can be improved on.)



BMP Designation	Okay	Not Okay	BMP Condition, Corrective Action Required.
Are all pollution sources controlled? Do any other problems exist?			
<i>[BMP # and Name] From SWPPP Template</i>			
<i>[BMP # and Name] From SWPPP Template</i>			
<i>[BMP # and Name] From SWPPP Template</i>			
<i>[BMP # and Name] From SWPPP Template</i>			
<i>[BMP # and Name] From SWPPP Template</i>			
<i>[BMP # and Name] From SWPPP Template</i>			
<i>[BMP # and Name] From SWPPP Template</i>			
<i>[BMP # and Name] From SWPPP Template</i>			
<i>[BMP # and Name] From SWPPP Template</i>			
<i>[BMP # and Name] From SWPPP Template</i>			
<i>[BMP # and Name] From SWPPP Template</i>			

**Overall Site Conditions** (These pages are suggested if the permittee chooses. They can be deleted if desired)

Concerns to be Checked	Implemented Y/N/NA	Maintained Y/N/NA	Corrective Action	Date Corrected
Are all slopes and disturbed areas not actively being worked properly stabilized?				
Are all water bodies (e.g., streams, wetlands) protected with buffers or similar BMPs?				
Are perimeter controls and sediment controls properly installed and maintained (anchored into soil)?				
Has the sediment build up been removed from BMPs designed to catch sediment?				
Are discharge points and receiving waters free of any sediment deposits?				
Is all sediment that has been deposited off site cleaned up?				
Are storm drain inlets properly protected?				
Does the construction exit have a track out pad (or other BMP)?				
Is the track out pad (or other BMP) effective in preventing sediment from being tracked into the street?				
Is trash/litter from work areas collected and placed in covered dumpsters?				
Are washout facilities (e.g., paint, stucco, concrete) available, clearly marked, and maintained?				
Are vehicle/equipment fueling, cleaning, and maintenance areas managed properly with no illicit discharges?				
Are fuels and construction materials and chemicals that are potential storm water contaminants covered or in secondary containment?				
Are non-storm water discharges (e.g., wash water, dewatering, wheel washing) properly controlled?				
Is run-on prevented or properly managed?				
Are there locations where additional BMP's are necessary?				
Are material piles protected from weather and placed on hard surfaces only day by day for placement and not for storage?				
Are all BMPs and storm water control measures accurately shown and updated on the SWPPP map?				



**Signature Block**

I certify under penalty of law that this document and all attachments were prepared under my direction or supervision in accordance with a system designed to assure that qualified personnel properly gathered and evaluated the information contained therein. Based on my inquiry of the person or persons who manage the system, or those persons directly responsible for gathering the information, the information contained is, to the best of my knowledge and belief, true, accurate, and complete. I am aware that there are significant penalties for submitting false information, including the possibility of fine and imprisonment for knowing violations.

**Print Name of Inspector**

**Date**

**Signature**



Appendix M – Notice for New Owner/Operators

## Ownership Transfer Form

Upon transfer of ownership or control of the subject property under this Permit (see section 8.2.2.a.) coverage under the UPDES CGP must continue until stabilization requirements are satisfied according to permit requirements. This requirement may be met by either of the following **transfer options** (this form is must be filled out and submitted to DWQ in either case):

1. Obtaining coverage under a new and independent Notice of Intent (NOI – the application process to procure coverage under the UPDES CGP). This results in a new permit tracking number for the new owner.
2. Coordinating with the previous owners and the State of Utah, Department of Environmental Quality, Division of Water Quality where ownership, other information, and signatures (including electronic certifications) contained in the NOI that is current for the property is changed to reflect the change in ownership and responsible parties for conducting construction activities (general contractor). For this step the new owner would assume the responsibilities of the original CGP coverage. This continues the original permit tracking number.

Name of Previous Owner	Telephone Number
------------------------	------------------

Address of Previous Owner	City	State	Zip
---------------------------	------	-------	-----

Signature of Previous Owner	Date
-----------------------------	------

Name of New Owner	Telephone Number
-------------------	------------------

Address of New Owner	City	State	Zip
----------------------	------	-------	-----

Signature of New Owner	Date
------------------------	------

Utah Construction General Permit (UCGP)

\_\_\_\_\_  
Name of Previous Operator Telephone Number

\_\_\_\_\_  
Address of Previous Operator City State Zip

\_\_\_\_\_  
Signature of Previous Operator Date

\_\_\_\_\_  
Name of New Operator Telephone Number

\_\_\_\_\_  
Address of New Operator City State Zip

\_\_\_\_\_  
Signature of New Operator Date

**PROJECT NAME AND LOCATION**

\_\_\_\_\_  
Previous Permit Number Name of Project

\_\_\_\_\_  
Address of Project City State Zip

\_\_\_\_\_  
Longitude Latitude

**WHAT KIND OF TRANSFER: PARTIAL OR TOTAL?**

Is this a transfer of ownership of partial or total of the permitted area? Partial   
Total

Utah Construction General Permit (UCGP)

If this is a transfer of part of the permitted area to a new owner, describe what part:

---

---

---

Will there be a new SWPPP prepared?      YES       NO

Please update the General Contractor Information (see transfer options 1 or 2, first page).  
If this is a partial transfer the only option is 1.

This form must be submitted to the Municipality of Jurisdiction and DWQ

To submit to DWQ either email to the construction storm water coordinator or,  
FAX to 801-535-4301

Or mail to      DWQ  
                    PO Box 144870  
                    Salt Lake City, UT 84114-4870



# Appendix D

STATE OF UTAH, DEPARTMENT OF ENVIRONMENTAL QUALITY, DIVISION OF WATER QUALITY 195 North 1950 West, P.O. Box 144870, Salt Lake City, Utah 84114-4870 (801) 536-4300	
<b>NOI</b>	Notice of Intent (NOI) for Storm Water Discharges Associated with Construction Activity Under the UPDES General Permit No. UTR375385 <u>SEE REVERSE FOR INSTRUCTIONS</u>
Submission of this Notice of Intent constitutes notice that the party(s) identified in Section I of this form intends to be authorized by UPDES General Permit No. UTR375385 issued for storm water discharges associated with construction activity in the State of Utah. Becoming a permittee obligates such discharger to comply with the terms and conditions of the permit. ALL NECESSARY INFORMATION MUST BE PROVIDED ON THIS FORM.	
Is this NOI seeking continuation for previously expired permit coverage at the same site?    Y <input type="checkbox"/> N <input type="checkbox"/> If yes, what is the number of the previous permit coverage?    Permit No.	
Permit Start Date 05/26/2016      Permit Expiration Date: 05/26/2017	
<b>I. OPERATOR INFORMATION</b>	
Name (Owner): E.K. Bailey Construction	Phone: 801-782-4748
Address: 1243 N Washington Blvd.	Status of Owner/Operator: PRIVATE
City: OGDEN	State: UT      Zip: 84404
Contact Person: Mike Grow	Phone: 801-698-7986
-----	
Name (Operator): E.K. Bailey Construction	Phone: 801-782-4748
Address: 1243 N Washington Blvd.	Status of Owner/Operator: PRIVATE
City: OGDEN	State: UT      Zip: 84404
Contact Person: Kraig Urry	Phone: 801-782-4748
<b>II. FACILITY SITE / LOCATION INFORMATION</b>	Is the facility located in Indian Country? Y <input type="checkbox"/> N <input type="checkbox"/>
Name: Sandhill Crane Cluster Subdivision	
Project No. (if any):	
Address: 2500 North Street	County: WEBER
City: EDEN	State: UT      Zip: 84310
Latitude: 41.303333	Longitude: 11.075833
Method (check one): <input type="checkbox"/> USGS Topo Map, Scale <input type="checkbox"/> EPA Web site <input type="checkbox"/> GPS <input checked="" type="checkbox"/> Other	
<b>III. SITE INFORMATION</b>	
Municipal Separate Storm Sewer System (MS4) Operator Name: Eden City	
Receiving Water Body: Existing irrigation ditch guess	this is known <input type="checkbox"/> this is a guess <input type="checkbox"/>
Estimate of distance to the nearest water body? 300 ft	ft. <input type="checkbox"/> miles. <input type="checkbox"/>
Is the receiving water an impaired or high quality water body (see <a href="http://wq.deq.utah.gov/">http://wq.deq.utah.gov/</a> )?    Yes <input type="checkbox"/> No <input checked="" type="checkbox"/>	
List the Number of any other UPDES permits at the site:	
<b>IV. TYPE OF CONSTRUCTION (Check all that apply)</b>	
1. <input type="checkbox"/> Residential    2. <input type="checkbox"/> Commercial    3. <input type="checkbox"/> Industrial    4. <input checked="" type="checkbox"/> Road    5. <input type="checkbox"/> Bridge    6. <input checked="" type="checkbox"/> Utility	
7. <input type="checkbox"/> Contouring, Landscaping    8. <input type="checkbox"/> Pipeline    9. <input type="checkbox"/> Other (Please list)	

# INSTRUCTIONS

## Notice Of Intent (NOI) For Permit Coverage Under the UPDES General Permit For Storm Water Discharges From Construction Activities

**Who Must File A Notice Of Intent (NOI) Form** State law at UAC R317-8-3.9 prohibits point source discharges of storm water from construction activities to a water body(ies) of the State without a Utah Pollutant Discharge Elimination System (UPDES) permit. The operator of a construction activity that has such a storm water discharge must submit a NOI to obtain coverage under the UPDES Storm Water General Permit. If you have questions about whether you need a permit under the UPDES Storm Water program, or if you need information as to whether a particular program is administered by EPA or a state agency, contact the storm water coordinator at (801) 536-4300.

**Where To File NOI Form** The preferred method of submitting an NOI to apply for the construction general storm water permit (CGP) is electronically on-line at <http://www.waterquality.utah.gov/UPDES/stormwatercon.htm>. The fee can be submitted on line also. If on-line is not an option for you send a paper form of the NOI to the following address:

Department of Environmental Quality  
Division of Water Quality  
P.O. Box 144870  
Salt Lake City, UT 84114-4870

**Beginning of Coverage** CGP coverages are issued immediately after submitting an NOI with the permit fee. The permittee should be aware that though you may not have a permit in hand, if you have submitted a completed NOI with the permit fee you are covered by the conditions in the permit and will be expected to comply with permit conditions. You can print a copy of the CGP from the DWQ web site.

**Permit Fees.** The permit fee is \$150.00 per year. The fee is paid by Visa/Master Card on-line when an NOI is filed (by check if submitted with a paper NOI). If the project continues for more than one year the fee must be submitted again in a renewal process on-line. CGP coverage will not be issued until the fee is paid.

**Length of Coverage:** CGP coverage starts the day that the NOI and fee is received at DWQ and expires a year from issuance. All CGP coverages must be renewed within 60-days after the yearly expiration date, or be terminated with a notice of termination (NOT) before the expiration date. To terminate the permit the site must meet the permit conditions for final stabilization (see permit definitions), or must continue under a different permit holder. In most cases the DWQ or municipality of jurisdiction will perform a final inspection when a CGP coverage submits an NOT. If the site passes the final inspection the permit is terminated.

The Storm Water General Permit for Construction Activities UTRC00000 will expire on May 30, 2019. The Clean Water Act requires that all UPDES permits be renewed every 5 years. If a project extends beyond the expiration date of the Permit it must continue coverage under the renewed permit that will subsequently be developed to continue the same or similar permit coverage for construction activity.

**SECTION I - FACILITY OPERATOR INFORMATION** Supply the legal name(s) of the person(s), firm(s), public organization(s), or any other entity(ies) that qualifies as the owner of the project (see permit definitions). Do the same for the operator (most commonly the general contractor) that conducts the construction operation at the facility or site to be permitted. The owner and the general contractor of the project may be the same.

Enter the complete address and telephone number of the owner and operator and a contact person and number for each. Enter the appropriate letter to indicate the legal status of the operator of the facility.

**F = Federal M = Public (other than Fed or State) S = State P = Private**

**SECTION II - FACILITY/SITE LOCATION INFORMATION** Enter the facility name or legal name and project number (if any) of the site and complete street address, including city, state and ZIP code. The latitude and longitude of the facility must be included to the approximate centroid of the site, and the method of how the Lat/Long was obtained (USGS maps, GPS, Internet Map sites [such as Google Earth], or other).

Indicate whether the facility is located in Indian Country. If the facility is located in Indian Country, do not complete this NOI, instead submit an application for coverage under a storm water permit to EPA Region VIII except for facilities on the Navajo Reservation or on the Goshute Reservation which should submit an application to EPA Region IX.

**SECTION III - SITE ACTIVITY INFORMATION** If the storm water discharges to a municipal separate storm sewer system (MS4), enter the name of the operator of the MS4 (e.g., the name of the City or County of jurisdiction) and the receiving water of the discharge from the MS4 if it is known (if it is not known please estimate or guess and indicate so). (An MS4 is defined as a conveyance or system of conveyances (including roads with drainage systems, municipal streets, catch basins, curbs, gutters, ditches, man-made channels, or storm drains) that is owned or operated by a state, city, town, county, district, association or other public body which is designed or used for collecting or conveying storm water).

**For Impaired Waters:** Go to <http://wq.deq.utah.gov> and identify the water body that will receive the storm water discharge from the permitted site, on the map provided at the web site (zoom in for easier resolution). On the left hand side of the page you will see “**2010 Assessment**” or “**2013 Assessment**” depending on the year you refer to the web site (the assessment is done every 3 years). The **20XX Assessment** the will indicate if the water is impaired. If there is nothing after **20XX Assessment** or the narrative after does not include the word “impaired”, your receiving water is not impaired.

**For High Quality Waters:** On the web page referred to in the paragraph above on the left hand side of the page you will see “**Anti-Degradation Category**”. Under **Anti-Degradation Category** you will see the category of the water body. Only categories 1 and 2 are high quality water bodies. Some waters may be both categories 1 and 3. If your water body is both category 1 and 3 it means the headwaters of your water body is within Forest Service boundaries, and because it is within Forest Service boundaries it is category 1. If your project is within Forest Service boundaries then your water body is category 1 and it is “high quality”. If your project is not within Forest Service boundaries then your water body is category 3 and is not “high quality”. Again, category 1 waters are high quality waters, category 3 waters are not high quality waters.

**SECTION IV - TYPE OF CONSTRUCTION** Check each type of construction that applies to this application.

**SECTION V - BEST MANAGEMENT PRACTICES** Check each type of best management practice that will be used to control storm water runoff at the job site.

**SECTION VI – GOOD HOUSEKEEPING PRACTICES** Check each type of good housekeeping practice that you will use on the site any time during construction activities.

**SECTION VII – ADDITIONAL** Provide an estimate of the total number of acres of the site on which soil will be disturbed (to the nearest hundredth of an acre). An email address is required of the best contact associated with the project for the communication needs.

**SECTION VIII – CERTIFICATION** State statutes provide for severe penalties for submitting false information on this application form. State regulations require this application to be signed as follows:

*For a corporation:* by a responsible corporate officer, which means: (i) president, secretary, treasurer, or vice-president of the corporation in charge of a principal business function, or any other person who performs similar policy or decision making functions, or (ii) the manager of one or more manufacturing, production, or operating facilities employing more than 250 persons or having gross annual sales or expenditures exceeding \$25 million (in second quarter 1980 dollars), if authority to sign documents has been assigned or delegated to the manager in accordance with corporate procedures;

*For a partnership or sole proprietorship:* by a general partner or the proprietor; or

*For a municipality, state, Federal, or other public facility:* by either a principal executive officer or ranking elected official.

**POLLUTION PREVENTION PLAN** A storm water pollution prevention plan (SWP3) is required to be in hand before the NOI can be submitted. It is important to know SWP3 requirements (contained in the permit) even during the design portion of the project. A copy of the permit can be obtained from the Division of Water Quality’s storm water construction web site. Guidance material for developing a SWP3 can be obtained from the Division of Water Quality’s storm water construction web site.

**V. BEST MANAGEMENT PRACTICES**

Identify proposed Best Management Practices (BMPs) to reduce pollutants in storm water discharges (Check all that apply):

- 1.  Silt Fence/Straw Wattle/Perimeter Controls
- 2.  Sediment Pond
- 3.  Seeding/Preservation of Vegetation
- 4.  Mulching/Geotextiles
- 5.  Check Dams
- 6.  Structural Controls (Berms, Ditches, etc.)
- 7.  Other (Please list)

**VI. GOOD HOUSEKEEPING PRACTICES**

Identify proposed Good Housekeeping Practices to reduce pollutants in storm water discharges (Check all that apply even if they apply only during a part of the construction time):

- 1.  Sanitary/Portable Toilet
- 2.  Washout Areas
- 3.  Construction Chemicals/Building Supplies Storage Area
- 4.  Garbage/Waste Disposal
- 5.  Non-Storm Water
- 6.  Track Out Controls
- 7.  Spill Control Measures

**VII. ADDITIONAL**

Estimated Area to be Disturbed (in Acres): 3.00

Total Area of Plot (in Acres): 5.00

A storm water pollution prevention plan has been prepared for this site and is to the best of my knowledge in Compliance with State and/or Local Sediment and Erosion Plans and Requirements. Y  N   
(A pollution prevention plan is required to be on hand before submittal of the NOI.)

Enter the best e-mail address to contact the permittee: kraig.urry@ekbailey.com

**VIII. CERTIFICATION:** I certify under penalty of law that I have read and understand the Part 1 eligibility requirements for coverage under the general permit for storm water discharges from construction activities. I further certify that to the best of my knowledge, all discharges and BMPs that have been scheduled and detailed in a storm water pollution prevention plan will satisfy requirements of this permit. I understand that continued coverage under this storm water general permit is contingent upon maintaining eligibility as provided for in Part 1.

I also certify under penalty of law that this document and all attachments were prepared under the direction or supervision of those who have placed their signature(s) below, in accordance with a system designed to assure that qualified personnel properly gather and evaluate the information submitted. Based on my inquiry of the person or persons who manage the system, or those persons directly responsible for gathering the information, the information submitted is, to the best of my knowledge and belief, true, accurate, and complete. I am aware that there are significant penalties for submitting false information, including the possibility of fine and imprisonment for knowing violations.

Print Name (Owner): JW Valley Investments

Date:

Signature:

Print Name (Operator): E.K. Bailey Construction

Date: 05/26/2016

Signature:

*Kraig Urry*

Amount of Permit Fee Enclosed: \$ 150.00

## Appendix F – Corrective Action Log

**Project Name:** Trails Crossing Buildings B&C  
**SWPPP Contact:** Mark Horton

<b>Inspection Date</b>	<b>Inspector Name(s)</b>	<b>Description of BMP Deficiency</b>	<b>Corrective Action Needed (including planned date/responsible person)</b>	<b>Date Action Taken/Responsible person</b>



# Appendix G – SWPPP Amendment Log

**Project Name:** Trails Crossing Buildings B&C  
**SWPPP Contact:** Mark Horton

Amendment No.	Description of the Amendment	Date of Amendment	Amendment Prepared by [Name(s) and Title]

## Appendix H – Subcontractor Certifications/Agreements

### SUBCONTRACTOR CERTIFICATION STORMWATER POLLUTION PREVENTION PLAN

Project Number: \_\_\_\_\_

Project Title: Sandhill Crane subdivision \_\_\_\_\_

Operator(s): \_\_\_\_\_

As a subcontractor, you are required to comply with the Stormwater Pollution Prevention Plan (SWPPP) for any work that you perform on-site. Any person or group who violates any condition of the SWPPP may be subject to substantial penalties or loss of contract. You are encouraged to advise each of your employees working on this project of the requirements of the SWPPP. A copy of the SWPPP is available for your review at the office trailer.

Each subcontractor engaged in activities at the construction site that could impact stormwater must be identified and sign the following certification statement:

**I certify under the penalty of law that I have read and understand the terms and conditions of the SWPPP for the above designated project and agree to follow the BMPs and practices described in the SWPPP.**

This certification is hereby signed in reference to the above named project:

Company: \_\_\_\_\_

Address: \_\_\_\_\_

Telephone Number: \_\_\_\_\_

Type of construction service to be provided: \_\_\_\_\_

\_\_\_\_\_  
\_\_\_\_\_

Signature: \_\_\_\_\_

Title: \_\_\_\_\_

Date: \_\_\_\_\_

## Appendix I – Grading and Stabilization Activities Log

**Project Name:** Trails Crossing Building B&C

**SWPPP Contact:** Mark Horton

Date Grading Activity Initiated	Description of Grading Activity	Date Grading Activity Ceased (Indicate Temporary or Permanent)	Date When Stabilization Measures are Initiated	Description of Stabilization Measure and Location

## Appendix J – SWPPP Training Log

### Stormwater Pollution Prevention Training Log

Project Name: **Trails Crossing Buildings B&C**

Project Location: **Daybreak Parkway**

Instructor's Name(s):

Instructor's Title(s):

Course Location: \_\_\_\_\_ Date: \_\_\_\_\_

Course Length (hours): \_\_\_\_\_

Stormwater Training Topic: *(check as appropriate)*

- Erosion Control BMPs       Emergency Procedures  
 Sediment Control BMPs       Good Housekeeping BMPs  
 Non-Stormwater BMPs

Specific Training Objective: \_\_\_\_\_  
\_\_\_\_\_

Attendee Roster: *(attach additional pages as necessary)*

No.	Name of Attendee	Company
1		
2		
3		
4		
5		
6		
7		
8		
9		
10		

## Appendix K – Delegation of Authority Form

### Delegation of Authority

I, Kraig Urry\_\_\_\_\_ (name), hereby designate the person or specifically described position below to be a duly authorized representative for the purpose of overseeing compliance with environmental requirements, including the Construction General Permit, at the \_Clearfield Parking Lot Expansion\_\_\_\_\_ construction site. The designee is authorized to sign any reports, stormwater pollution prevention plans and all other documents required by the permit.

Mark Horton – SWPPP Inspector \_\_\_\_\_ (name of person or position)  
E.K. Bailey Construction \_\_\_\_\_ (company)  
1243 N. Washington Blvd. \_\_\_\_\_ (address)  
Ogden, UT 84404 \_\_\_\_\_ (city, state, zip)  
801-430-5765 \_\_\_\_\_ (phone)

By signing this authorization, I confirm that I meet the requirements to make such a designation as set forth in \_\_UTR 00000\_\_\_\_\_ (Reference State Permit), and that the designee above meets the definition of a “duly authorized representative” as set forth in \_\_UTR 00000\_\_\_\_\_ (Reference State Permit).

I certify under penalty of law that this document and all attachments were prepared under my direction or supervision in accordance with a system designed to assure that qualified personnel properly gathered and evaluated the information submitted. Based on my inquiry of the person or persons who manage the system, or those persons directly responsible for gathering the information, the information submitted is, to the best of my knowledge and belief, true, accurate, and complete. I am aware that there are significant penalties for submitting false information, including the possibility of fine and imprisonment for knowing violations.

**Name:** Kraig Urry\_\_\_\_\_

**Company:** E.K. Bailey Construction\_\_\_\_\_

**Title:** Project Engineer\_\_\_\_\_

**Signature:** Kraig Urry\_\_\_\_\_

**Date:** May 26, 2016\_\_\_\_\_